

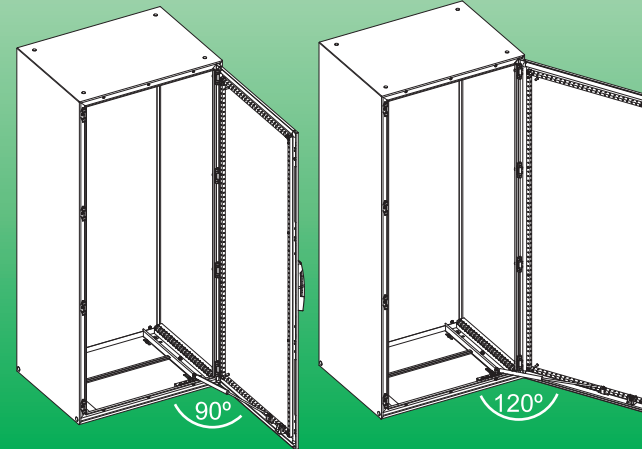





PanelSeT SM

- en** Pneumatic Door Stop
- fr** Limiteur d'ouverture pneumatique
- es** Retenedor de puerta neumático



-  **type 1**
M6
3 Nm
26,55 lb-in
-  **type 2**
●⊕M6 / T30
3 Nm
26,55 lb-in
-  **type 3**
M8
3 Nm
26,55 lb-in
-  **type 4**
M8
-  **type 5**
8,4
- type 6**
6,4

⚠ CAUTION / ATTENTION / ATENCIÓN / VORSICHT / ATTENZIONE / CUIDADO / 小心 / ВНИМАНИЕ

<p>HAZARD OF EQUIPMENT DAMAGE Respect the information provided in the instruction to ensure the functioning of the product. Failure to follow these instructions can result in injury or equipment damage.</p>	<p>RISQUE DE DETERIORATION DU MATERIEL Respecter les informations fournies sur la notice pour garantir le fonctionnement du produit. Si ces directives ne sont pas respectées, cela peut entraîner des blessures ou des dommages matériels.</p>
<p>RIESGO DE DETERIORO DEL MATERIAL Respetar la información proporcionada en las instrucciones para garantizar el funcionamiento del producto. El incumplimiento de estas instrucciones puede causar lesiones o daño al equipo.</p>	<p>GEFAHR VON MATERIALSCHÄDEN Beachten Sie die Angaben in der Betriebsanleitung zur Verfügung gestellt, um die Funktionsweise des Produkts zu gewährleisten. Die Nichtbeachtung dieser Anweisungen kann Verletzungen oder Sachschäden zur Folge haben.</p>
<p>RISCHIO DI DANNI ALLE APPARECCHIATURE Rispettare le istruzioni fornite per garantire il funzionamento del prodotto. Il mancato rispetto di queste istruzioni può provocare infortuni o danni alle apparecchiature.</p>	<p>RISCO DE DETERIORAÇÃO DO MATERIAL Respeitar as informações fornecidas no manual de instruções para assegurar o funcionamento do produto. A não observância destas instruções pode provocar ferimentos pessoais, ou danos no equipamento.</p>
<p>设备受损风险 为保证正常使用该产品请仔细阅读本产品说明书。 不遵循上述说明可能导致人身伤害或设备损坏。</p>	<p>ОПАСНОСТЬ ПОВРЕЖДЕНИЯ ОБОРУДОВАНИЯ Следуйте информации, указанной в инструкции, для гарантии правильного функционирования продукта. Несоблюдение этих инструкций может привести к травме или повреждению оборудования.</p>

Schneider Electric Industries SAS

35, rue Joseph Monier
CS 30323
F- 92506 Rueil Malmaison Cedex
www.se.com

 Ce document a été imprimé sur du papier écologique.
This document has been printed on ecological paper.

7313730001-03

© 2024 - Schneider Electric - All rights reserved.

Ce produit doit être installé, raccordé et utilisé en respectant les normes et/ou les règlements d'installation en vigueur.
En raison de l'évolution des normes et du matériel, les caractéristiques et cotes d'encombrement/données ne nous engagent qu'après confirmation par nos services.

This product must be installed, connected and used in compliance with prevailing standards and/or installation regulations.
As standards, specifications and designs change from time to time, always ask for confirmation of the information given in this publication.

7313730001-03

07/2024

1/4

Schneider
 Electric™

