

## Proportional flow control valve VEMD

**FESTO**



## Key features

### Description

Thanks to the integrated low-noise piezo technology, minimal energy consumption and compact dimensions, the valve VEMD is perfectly suited to mobile applications.

#### Advantages:

- Very low energy consumption
- High dynamic response
- No self-heating
- Absolutely silent
- Excellent price/performance ratio
- Sturdy and durable
- Linear control response
- Small installation space
- Minimal weight

### Mode of operation

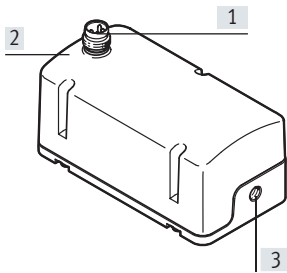

- [1] Electrical connection
- [2] Connection 1 (pressure supply connection)
- [3] Connection 2 (working connection)

The VEMD is a mass flow controller with integrated piezo actuator. The flow rate is controlled via a closed-loop control circuit with integrated thermal sensor.

An analogue interface allows the setpoint value for the flow rate to be specified and the actual value to be fed back.

### Range of application

The proportional flow control valve VEMD is intended to be used for controlling the flow of air and inert gases in relation to a specified setpoint value.

The flow control valve is suitable for applications in medical technology within the bounds of the specified technical characteristics.

For applications with special requirements, such as with regard to hygiene and sterility, additional measures may be required.

### Low energy consumption

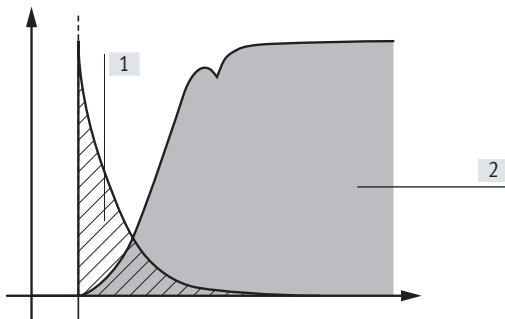

Compared with solenoid valves, proportional valves with piezo technology require virtually no energy to maintain an active state thanks to their capacitive principle. The piezo valve operates like a capacitor: it needs current only at the start in order to charge the piezoceramics.

No further energy is needed to maintain its state. The valves therefore generate no heat. They consume up to 95% less energy than solenoid valves, which permanently require an electrical current.

Y-axis: Current I

X-axis: Time t

- [1] Striped area: Piezo valve
- [2] Grey area: Solenoid valve

### Mounting

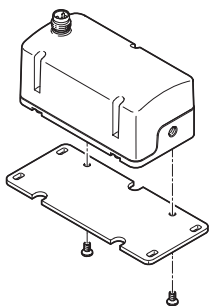

The valve VEMD is mounted on the wall mounting VAME-P14-W using two screws.

## Product range overview

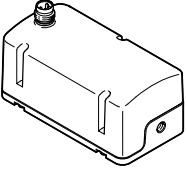
	Function	Description	Nominal operating voltage	Setpoint value	Flow rate control range	Operating pressure	
			[V DC]			[V]	[MPa]
	Proportional flow control valve	Mass flow controller, 2-way valve, normally closed	24	0.2 ... 10	0 ... 20	0 ... 0.25	0 ... 2.5
			12				

## Peripherals overview

### VEMD on mounting plate

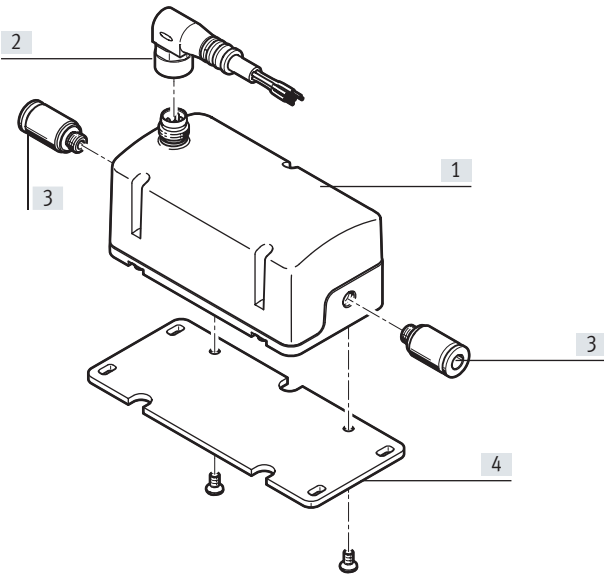



Designation	Brief description	→ Page/Internet
[1] Proportional flow control valve VEMD	–	10
[2] Connecting cable NEBU	–	10
[3] Push-in fitting QSM/NPQM	For connecting compressed air tubing with standard O.D.	10
[4] Mounting plate VAME-P14	For mounting the valve	10

## Type codes

001	Series	006	Pressure range [bar]
VEMD	Proportional flow control valve	D21	0 ... 2.5
002	Directional control valve type	007	Pneumatic connection
L	In-line valve	M5	M5
003	Valve function	008	Nominal operating voltage
6	2/2-way valve, normally closed	1	24 V DC
004	Nominal width [mm]	5	12 V DC
1.4	1.4[null]	009	Electrical connection
005	Flow rate range	R1	Individual connector M8, 4-pin
20	20 l/min	010	Setpoint input for individual valves
		V4	0.2 ... 10 V

## Datasheet

-  Flow rate control range  
0 ... 20 l<sub>n</sub>/min
-  Voltage  
12, 24 V DC
-  Operating pressure  
0 ... 0.25 MPa



### General technical data

Valve function		2-way proportional flow regulator
Flow rate control range <sup>1)</sup>	[l <sub>n</sub> /min]	0 ... 20
Dimensions W x L x H	[mm]	37x70x31
Nominal width	[mm]	1.4
Pneumatic connection 1, 2		Female thread M5
Type of mounting		Direct mounting via thread
Mounting position		Any
Flow direction		Not reversible
Product weight	[g]	92

1) The flow is calibrated at the factory to the physical standard conditions in accordance with DIN 1343 (1013 mbar, 0°C)

### Electrical data

		VEMD-L-6-14-20-D21-M5-1-R1-V4	VEMD-L-6-14-20-D21-M5-5-R1-V4
Electrical connection		Plug, M8x1, 4-pin, to EN 61076-2-104	
Nominal operating voltage	[V DC]	24	12
Operating voltage range	[V DC]	22 ... 26.4	11.1 ... 13.2
Analogue input signal range	[V]	0.2 ... 10	
Analogue output signal range	[V]	0.2 ... 10	
Setpoint value	[V]	0.2 ... 10	
Max. electrical power consumption	[W]	1	
Max. current consumption	[mA]	40	65
Duty cycle	[%]	100	
Reverse polarity protection		For operating voltage connections	
Degree of protection		IP40, in any mounting position	
		IP51, in horizontal mounting position	

## Datasheet

Operating and environmental conditions		
Operating pressure	[MPa]	0 ... 0.25
	[bar]	0 ... 2.5
Overload pressure	[MPa]	0.6
	[bar]	6
	[psi]	87
Burst pressure	[MPa]	1
	[bar]	10
	[psi]	145
Medium		<ul style="list-style-type: none"> <li>Oxygen (oxygen applications according to IEC 60601-1 only on request)</li> <li>Compressed air to ISO 8573-1:2010 [5:4:1]</li> <li>Inert gases</li> <li>Nitrogen</li> </ul>
Note on the medium		Lubricated operation not possible
Ambient conditions		Not suitable for use in an oxygen-enriched environment according to IEC 60601-1
Special characteristics		Oxygen-compatible to DIN EN 1797
Accuracy of flow rate	[%]	± (4% o.m.v. + 1.25% FS)
Repetition accuracy FS	[%]	1
Hysteresis FS	[%]	2.5
Linearity error FS	[%]	2
Temperature coefficient K	[%]	0.1
Ambient temperature	[°C]	0 ... 50
Temperature of medium	[°C]	5 ... 40
Storage temperature	[°C]	- 20 ... 70
Certification		RCM
Conforms to standard		EN 61000-6-2 (EMC)
		EN 61000-6-3 (EMC)
CE marking (see declaration of conformity)		To EU EMC Directive <sup>1)</sup>
		To EU RoHS Directive <sup>1)</sup>
UKCA marking (see declaration of conformity)		UK regs EMC <sup>1)</sup>
		UK regs RoHS <sup>1)</sup>
KC mark		KC EMC

1) For information about the area of use, see the EC declaration of conformity at: [www.festo.com/catalogue/...](http://www.festo.com/catalogue/...) → Support/Downloads.

If the devices are subject to usage restrictions in residential, commercial or light-industrial environments, further measures for the reduction of the emitted interference may be necessary.

Materials	
Seals	EPDM, NBR
Housing	Reinforced PA
Note on materials	RoHS-compliant
PWIS conformity	VDMA24364 zone III

## Circuit symbol

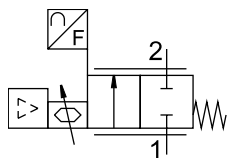

2-way valve, normally closed

Pin allocation			
	Pin	Function	
		VEMD-L-6-14-20-D21-M5-1-R1-V4	VEMD-L-6-14-20-D21-M5-5-R1-V4
	1	+24 V DC supply voltage	+12 V DC supply voltage
	2	+ Setpoint value 0.2 ... 10 V	
	3	GND	
	4	+ Actual value 0.2 ... 10 V	

## Datasheet

### Flow rate $q_n$ as a function of setpoint value $s$

Complete range of values

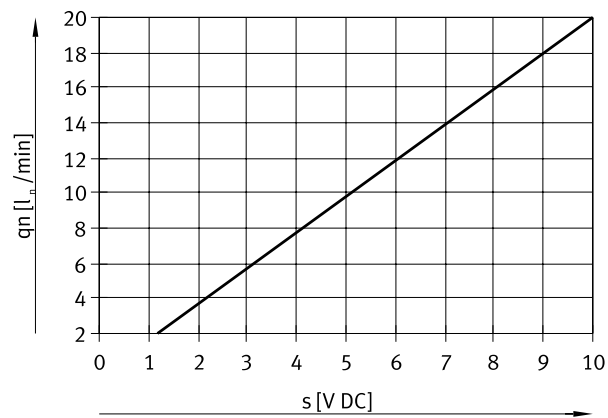

The range in detail

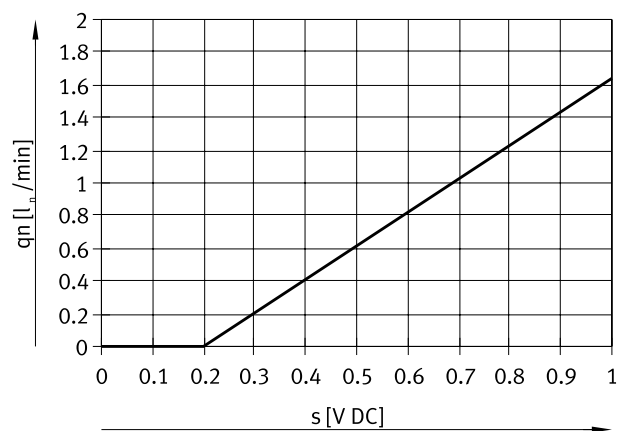

Formula for calculating the setpoint value  $s$  as a function of the required nominal flow rate

$$s = \frac{9,8 \cdot (q_n + 4 \div 9,8)}{20}$$

### Maximum flow rate plotted against operating pressure, at room temperature

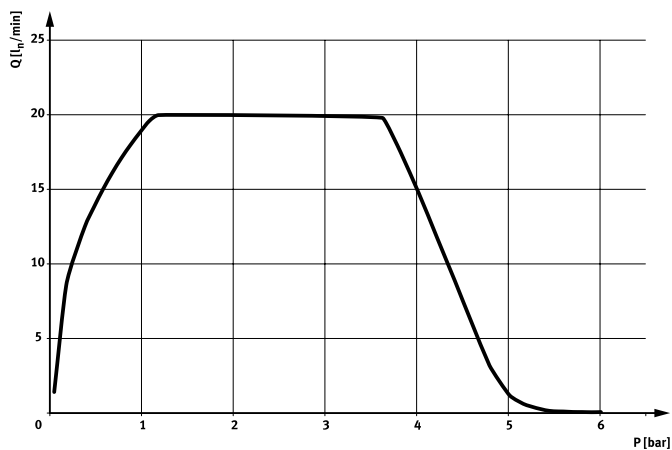



Datasheet

Dimensions

Download CAD data → [www.festo.com](http://www.festo.com)

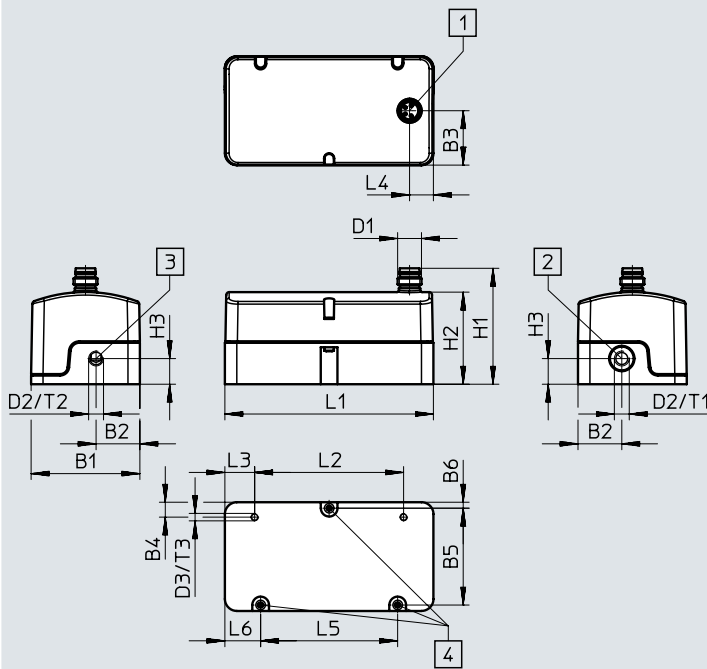

- [1] Connecting plug, 4-pin
- [2] Pressure supply port 1
- [3] Working port 2
- [4] Mounting points through-holes  
Ø 2.2 mm

Type	B1	B2	B3	B4	B5	B6	D1	D2	D3
VEMD	36.5	14.7	18.3	5	32.5	2	M8x1	M5	M2.5

Type	H1	H2	H3	L1	L2	L3	L4	L5	L6	T1	T2	T3
VEMD	38.9	30.9	8.6	70	50	10	8	46	12	8	5	5

Dimensions

Download CAD data → [www.festo.com](http://www.festo.com)

Wall mounting

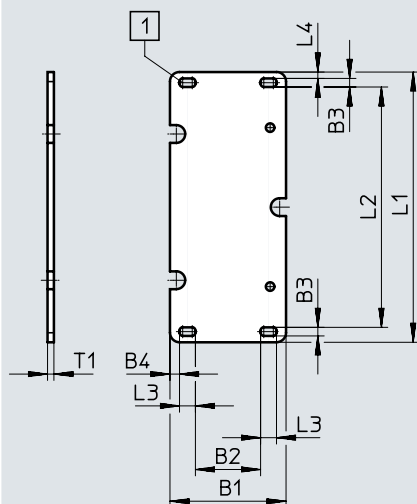

- [1] Mounting recess

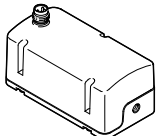

Type	B1	B2	B3	B4	L1	L2	L3	L4	T1
VAME-P14-W	36.5	20.5	2.7	3	85	75.6	5	2	2

Accessories

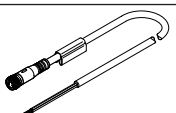
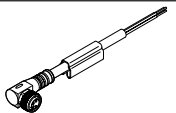
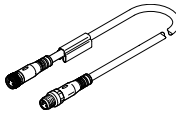
Ordering data		Operating pressure		Nominal operating voltage	Part no.	Type
Description	[MPa]	[bar]	[V DC]			
Proportional flow control valve						
	Mass flow controller, 2-way valve, normally closed	0 ... 0.25	0 ... 2.5	24	<b>8086472</b>	<b>VEMD-L-6-14-20-D21-M5-1-R1-V4</b>
				12	<b>8086473</b>	<b>VEMD-L-6-14-20-D21-M5-5-R1-V4</b>

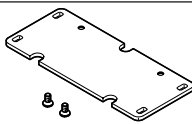
Ordering data		Description		Part no.	Type
Connecting cable					
Datasheets → Internet: nebu					
	Straight socket, M8x1, 4-pin Open end, 4-wire		2.5 m	<b>541342</b>	<b>NEBU-M8G4-K-2.5-LE4</b>
			5 m	<b>541343</b>	<b>NEBU-M8G4-K-5-LE4</b>
	Angled socket, M8x1, 4-pin Open end, 4-wire		2.5 m	<b>541344</b>	<b>NEBU-M8W4-K-2.5-LE4</b>
	Straight socket, M8x1, 4-pin Straight plug M8x1, 4-pin		2.5 m	<b>554035</b>	<b>NEBU-M8G4-K-2.5-M8G4</b>
			5 m	<b>541345</b>	<b>NEBU-M8W4-K-5-LE4</b>

Wall mounting		Description	Part no.	Type
	For mounting the valve			

Push-in fitting, male thread M5					
	With internal hex	Metal design	For tubing O.D. 4 mm	<b>558657</b>	<b>NPQM-DK-M5-Q4-P10</b>
			For tubing O.D. 6 mm	<b>558658</b>	<b>NPQM-DK-M5-Q6-P10</b>
		Polymer design	For tubing O.D. 3 mm	<b>153313</b>	<b>QSM-M5-3-I</b>
			For tubing O.D. 4 mm	<b>153315</b>	<b>QSM-M5-4-I</b>
	With external hex	Metal design	For tubing O.D. 6 mm	<b>153317</b>	<b>QSM-M5-6-I</b>
			For tubing O.D. 3 mm	<b>153302</b>	<b>QSM-M5-3</b>
			For tubing O.D. 4 mm	<b>153304</b>	<b>QSM-M5-4</b>
			For tubing O.D. 6 mm	<b>153306</b>	<b>QSM-M5-6</b>

# Festo - Your Partner in Automation



**1 Festo Inc.**  
5300 Explorer Drive  
Mississauga, ON L4W 5G4  
Canada

**Festo Customer Interaction Center**  
Tel: 1 877 463 3786  
Fax: 1 877 393 3786  
Email: [customer.service.ca@festo.com](mailto:customer.service.ca@festo.com)



**2 Festo Pneumatic**  
Av. Ceylán 3,  
Col. Tequesquináhuac  
54020 Tlalnepantla,  
Estado de México

**Multinational Contact Center**  
01 800 337 8669  
[ventas.mexico@festo.com](mailto:ventas.mexico@festo.com)



**3 Festo Corporation**  
1377 Motor Parkway  
Suite 310  
Islandia, NY 11749

**Festo Customer Interaction Center**  
1 800 993 3786  
1 800 963 3786  
[customer.service.us@festo.com](mailto:customer.service.us@festo.com)



**4 Regional Service Center**  
7777 Columbia Road  
Mason, OH 45040

Connect with us



[www.festo.com/socialmedia](http://www.festo.com/socialmedia)



[www.festo.com](http://www.festo.com)

Subject to change