

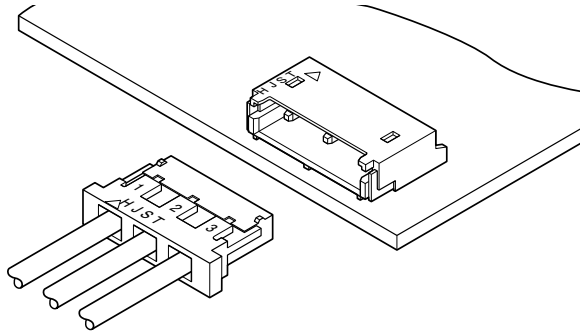

BH CONNECTOR



4.0/8.0/12.0 mm pitch/Disconnectable Crimp style connectors



Low profile connectors with high withstanding voltage, designed for connecting liquid crystal display back light lamps to their starters.

- Low profile
- SMT configuration
- Applicable to special wires
- Headers with locating bosses
- Housing lock also serves as polarizing device

Specifications

- Current rating: 1.0 A AC/DC (AWG #22)
- Voltage rating: 600 V AC/DC
- Temperature range: -25°C to +85°C
(including temperature rise in applying electrical current)
- Contact resistance: Initial value/ 10 mΩ max.
After environmental tests/ 20 mΩ max.
- Insulation resistance: 1,000 MΩ min.
- Withstanding voltage: 1,800 VAC/minute
- Applicable wire: AWG #28 to #22

* In using the products, refer to "Handling Precautions for Terminals and Connectors" described on our website (Technical documents of Product information page).

- * RoHS2 compliance
- * Dimensional unit: mm
- * Contact JST for details.

Standards

- Ⓜ Recognized E60389
- Ⓢ Certified LR20812

PC board layout (viewed from component side)

SMT type

4 mm pitch/ 2-circuit

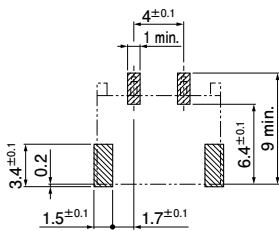

8 mm pitch/ 2-circuit

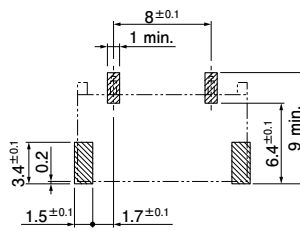

8 mm pitch/ 2-circuit with boss

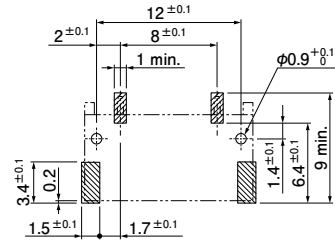

8 mm pitch/ 2-circuit with plugged up hole

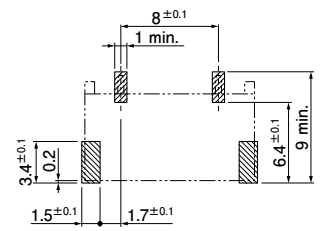

12 mm pitch/ 2-circuit

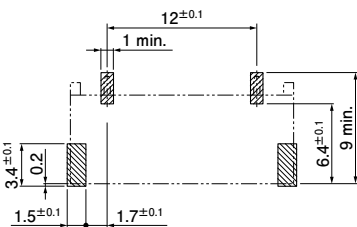

4 mm pitch/ 3-circuit

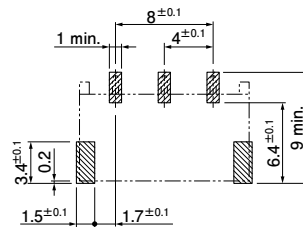

4 mm pitch/ 3-circuit with plugged up hole

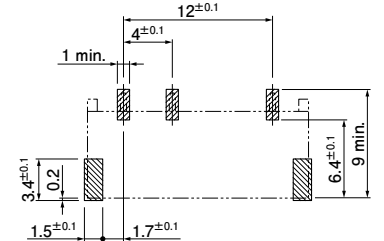

4 mm pitch/ 4-circuit

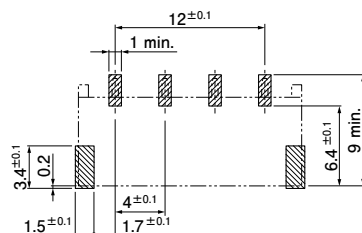

4 mm pitch/ 4-circuit with post removed

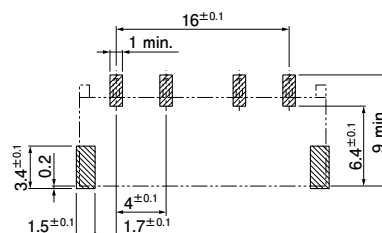

Through-hole type

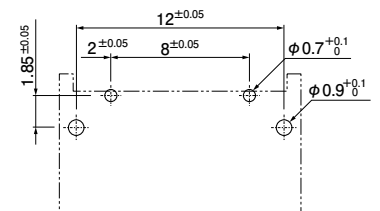

Note: 1. Tolerances are for pattern non-cumulative: ± 0.05 mm for all centers. Tolerance for hole size is ± 0.1.

2. Hole dimensions differ according to the type of PC board and piercing method. The dimensions above should serve as guideline. Contact JST for details.

BH CONNECTOR

Contact

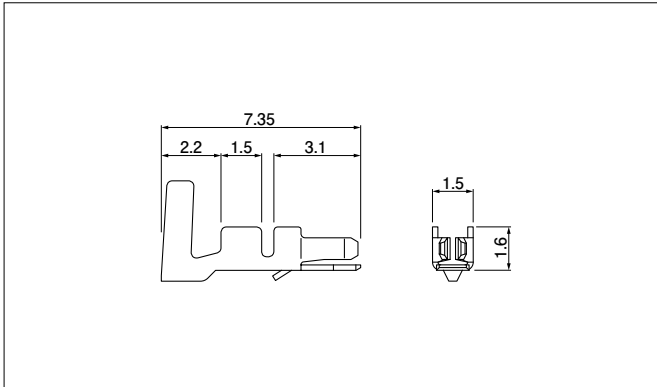

Model No.	Applicable wire		Insulation O.D. (mm)	Q'ty/reel
	mm ²	AWG #		
SBH-001T-P0.5	0.08 to 0.33	28 to 22	1.6 to 2.4	4,000

Material and Finish

Phosphor bronze, tin-plated (reflow treatment)

RoHS2 compliance

Note: Wire conductor shall be an annealed copper stranded wire with tin coating.

Contact	Crimping machine	Applicator		
		Crimp applicator	Dies	Crimp applicator with dies
SBH-001T-P0.5	AP-K2N	MKS-L	MK/SBH/M-001-05	APLMK SBH/M001-05

Note: Contact JST for fully automatic crimping applicator.

Housing

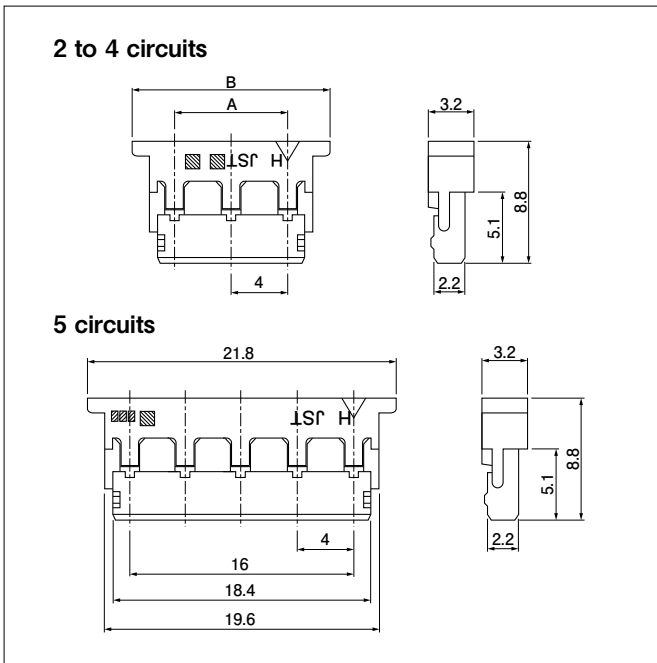

No. of circuits	Pitch (mm)	Model No.	Dimensions (mm)		Q'ty/bag
			A	B	
2	4	BHR-02VS-1	4.0	9.8	1,000
	8	BHR-03VS-1	8.0	13.8	1,000
	Note1) 8	BHR-02(8.0)VS-1N	8.0	13.8	1,000
	12	BHR-04VS-1	12.0	17.8	1,000
3	4	BHR-03VS-1	8.0	13.8	1,000
	Note2) 4	BHR-03(4-3)VS-1N	12.0	17.8	1,000
4	4	BHR-04VS-1	12.0	17.8	1,000
5	4	BHR-05VS-1	16.0	21.8	1,000

Material and Finish

PA 66, UL94V-0, natural (white)

RoHS2 compliance

Note: 1. 2-circuit 8.0 mm pitch plugged up with resin.
2. The 3'rd circuit of 4-circuit 4.0 mm pitch housing is plugged up with the resin.

Header (Through-hole type)

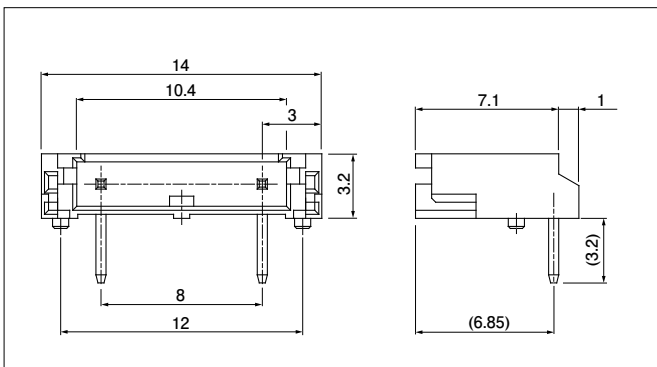

No. of circuits	Pitch (mm)	Model No.	Q'ty/tray
2	8	S02(8.0)B-BHS	1,000

Material and Finish

Post: Copper alloy, copper-undercoated, tin-plated (reflow treatment)
Wafer: PA, UL94V-0, natural (ivory)

RoHS2 compliance

Note: The applicable housing is "BHR-02(8.0)VS-1N" only.

Header (SMT type)

● 4 mm pitch/ 2-circuit

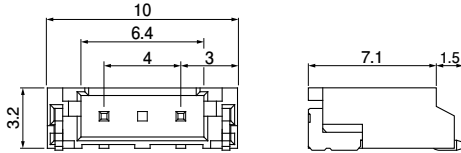

● 8 mm pitch/ 2 circuit

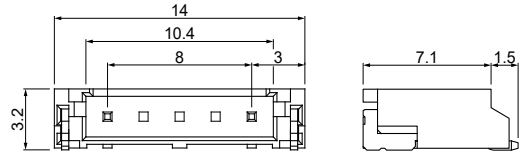

● 8 mm pitch/ 2-circuit with boss Note 1)

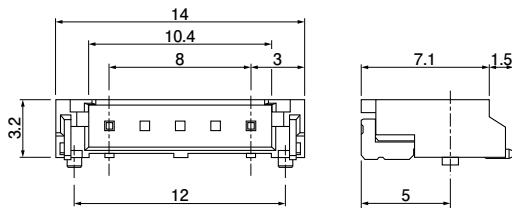

● 8 mm pitch/ 2-circuit with plugged up hole Note 2)

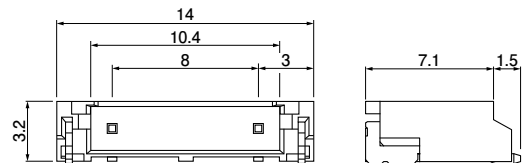

● 8 mm pitch/ 2-circuit with ribs for preventing pried insertion Note 4)

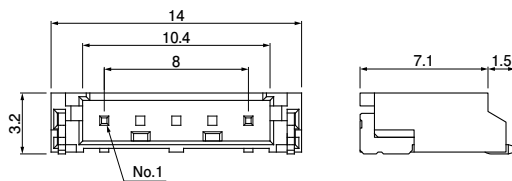

● 12 mm pitch/ 2-circuit

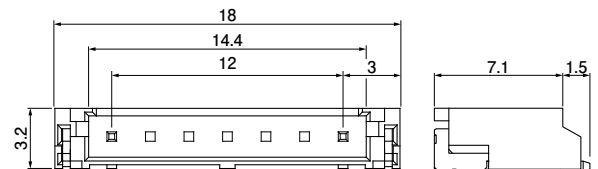

● 4 mm pitch/ 3-circuit with plugged up hole Note 3)

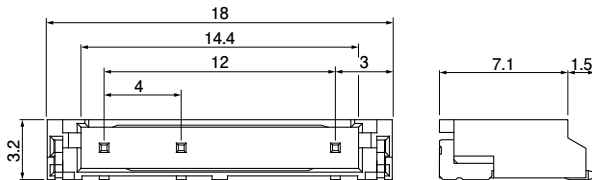

● 4 mm pitch/ 3-circuit

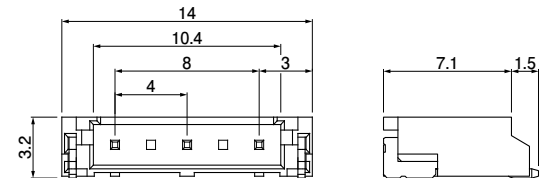

● 4 mm pitch/ 4-circuit

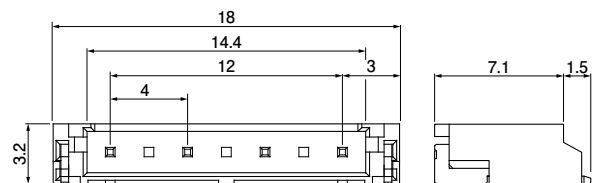

● 4 mm pitch/ 4-circuit with post removed Note 5)

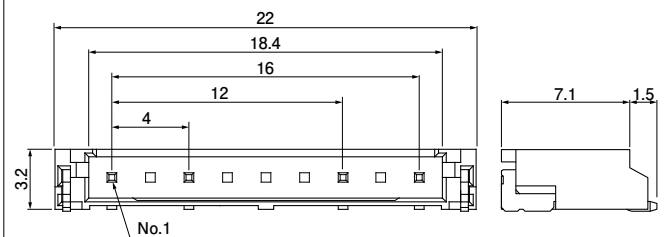

No. of circuits	Pitch(mm)	Model No.	Q'ty/reel
2	4	SM02(4.0)B-BHS-1-TB	1,000
	8	SM02(8.0)B-BHS-1-TB	1,000
	Note1) 8	SM02(8.0)B-BHS-TB	1,000
	Note2) 8	SM02(8.0)B-BHS-1N-TB	1,000
	Note4) 8	SM02(8.0)B-BHS-1R-TB	1,000
3	12	SM02(12)B-BHS-1-TB	1,000
	4	SM03(4.0)B-BHS-1-TB	1,000
3	Note3) 4	SM03(7-D1)B-BHS-1N-TB	1,000
4	4	SM04(4.0)B-BHS-1-TB	1,000
5	Note5) 4	SM04(9-E2)B-BHS-1-TB	1,000

Material and Finish

Post: Copper alloy, copper-undercoated, tin-plated (reflow treatment)
 Wafer: PA, UL94V-0, natural (ivory)
 Solder tab: Brass, copper-undercoated, tin-plated (reflow treatment)

RoHS2 compliance This product displays (LF)(SN) on a label.

Note: 1. Header with bosses. Contact JST for other circuits headers with bosses.

2. 2-circuit 8.0 mm pitch plugged up with resin

3. The 3' rd circuit of 4-circuit 4.0 mm pitch header is plugged up with the resin.

4. Header with ribs for preventing pried insertion

Contact JST for other circuits headers with ribs for preventing pried insertion.

5. 5-circuit 4.0 mm pitch header with the 3'rd post removed

6. The products listed above are supplied on embossed tape.

7. Products with bosses supplied in loose piece are also available. Contact JST for details.

BH CONNECTOR

Model number allocation

Contact

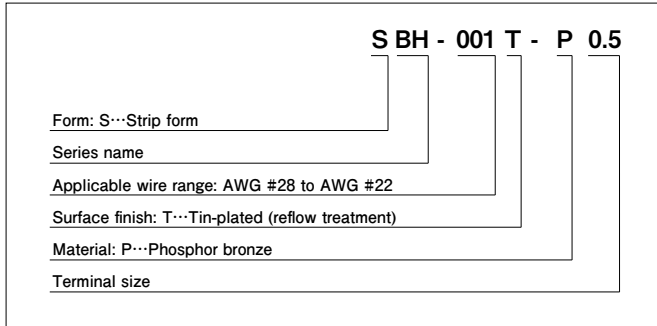

Housing

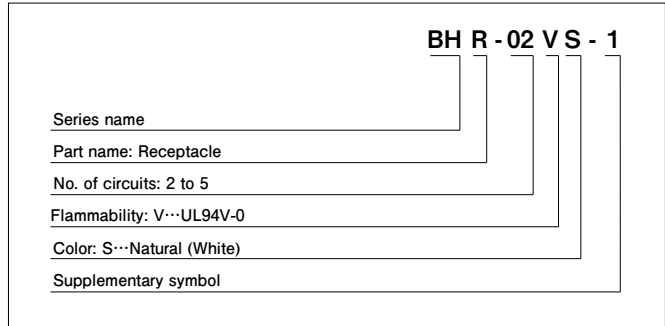

Housing

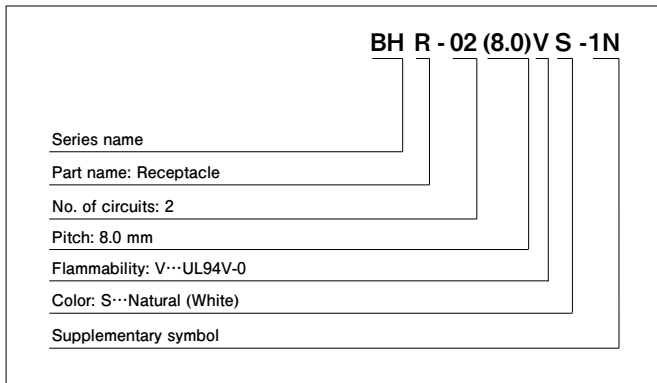

Housing

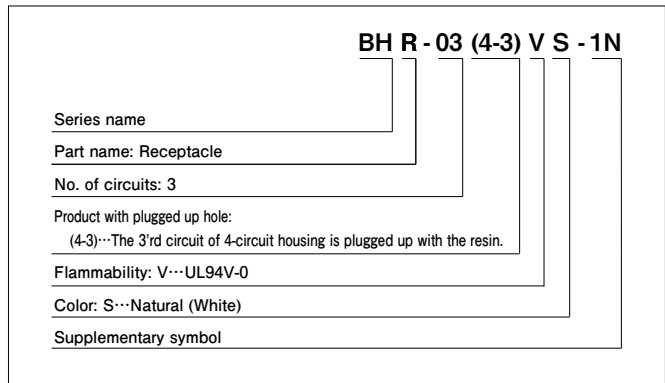

Header (Through-hole type)

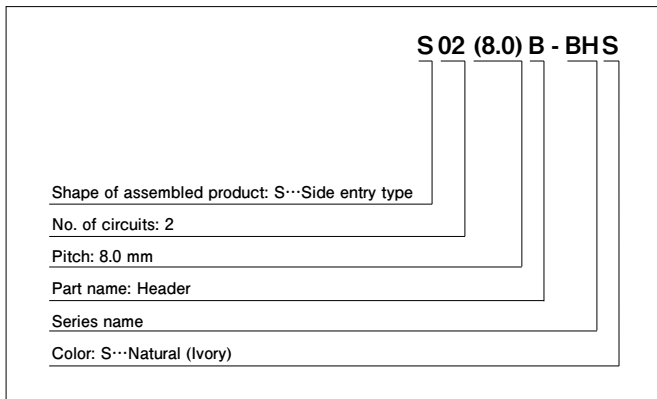

Header (SMT type)

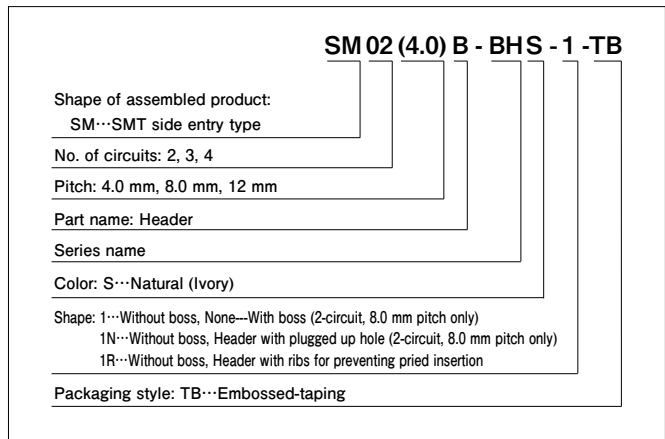

Header (SMT type)

