

# Naphtha Steam Cracking (NSC) unit optimization

The use of robust on-line analyzer technology for the real-time optimization of steam-cracking furnace operation



This white paper illustrates how the fast response times and excellent repeatability of on-line FT-NIR and other analyzers can be used to provide complete real-time data for the optimization of naphtha steam-cracking furnaces.

## Measurement made easy

—  
Refinery

First, we need to look at the background: why real-time optimization of the steam-cracking furnace is so necessary and what analytical tools exist to help.

Ethylene production runs at around 175 M tons per year, the vast majority of which is produced by steam-cracking light hydrocarbons – ethane where it is readily and cheaply available, liquid feeds such as naphtha or, less commonly, gas oil where it is more advantageous. The use of naphtha as a feedstock has significant additional advantages where the end-customer market is dynamic in terms of demand and pricing, since naphtha feedstocks

also generate added-value co-products such as propylene, butenes (for butadiene production) and a high aromatics content pygas product. This allows for operation of the steam-cracker in campaign mode, the better to tune product spectrum to market opportunity.

### **Dr. Michael B. Simpson**

Industry Manager, Refining and Petrochemicals  
ABB Measurement & Analytics

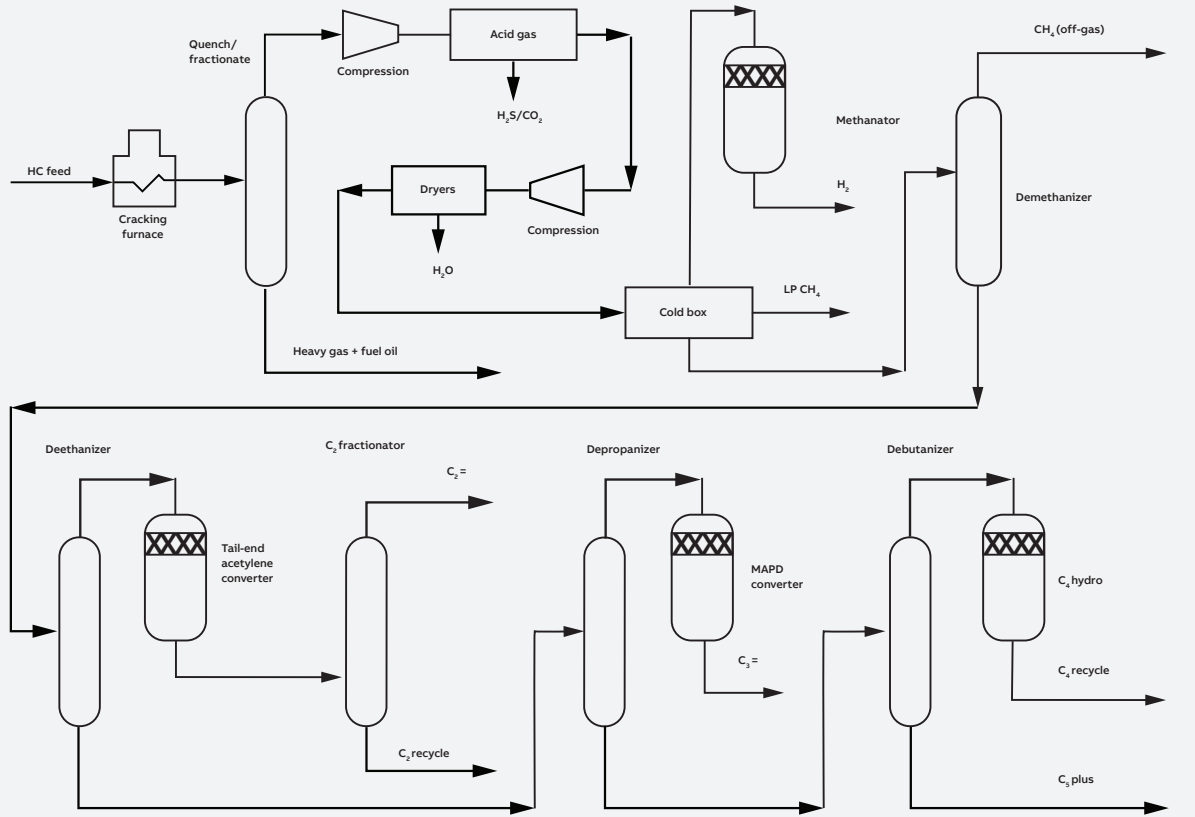

The cracking, quenching, compression, and recovery stages of a steam-cracking unit

The steam-cracking process involves multiple stages including, mainly, the cracking furnace, quench, downstream compression, and recovery / purification. The feed to the cracking furnace is pre-heated and mixed with steam at a controlled charge rate and steam-to-hydrocarbon ratio, and then passed rapidly through the radiant section of the furnace. The residence time is extremely short (of the order of 0.08 to 0.25 seconds) and the cracking temperature high (around 750 to 850 °C / 1382 to 1562 °F). This generates a huge volume of cracked effluent gas consisting primarily of ethylene and propylene, but with other co-products as indicated above. This high-temperature gas flow passes initially through transfer-line heat exchangers and through a main quench tower to immediately halt further reaction and inhibit the build-up of side-products. Subsequently, the gas flow passes through a multi-stage compressor train and thence to the steam-cracking unit cold section for recovery, separation, and purification.

The critical point is that the entire efficiency and profitability of the steam-cracking unit is defined by the furnace effluent gas quality and yield. The downstream stages make the best of what has been produced, but cannot impact the furnace itself.

The key problem in furnace operation is to balance cracking severity against throughput, propylene / ethylene yield and selectivity, all of which can impact the gas-make, the capacity of the downstream separation and compression train and the risk of unacceptable furnace tube coking. The ideal furnace set-point (for example – measured as the coil outlet temperature [COT]) will be, amongst other factors, critically dependent upon the composition of the liquid naphtha feed. A relatively light paraffinic naphtha will crack more easily and yield a higher volume of gas without risk of furnace coking – thus allowing a higher severity setting and yield, up to the limit of the downstream compressor train. A more aromatic naphtha at the same severity would severely reduce furnace run-lengths by excessive coking.

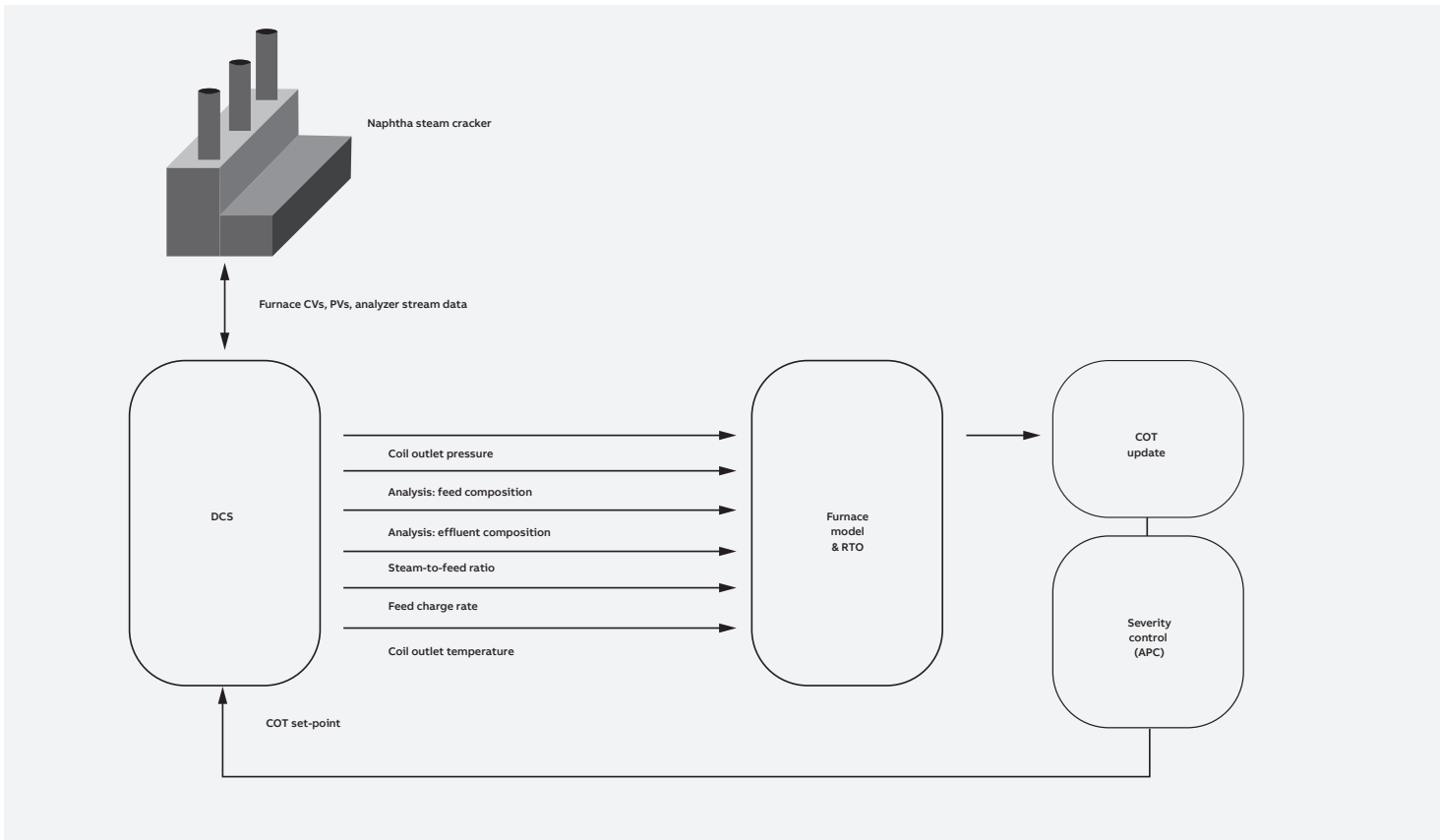

Furnace severity control using dynamic COT set-point with feed composition and effluent analysis

**Maintaining ethylene yield% using severity-based control vs operation at constant COT for variable feed quality**

Measurement at some level is the key to process optimization. Measurement yields information which allows for the possibility of control. What form this measurement takes is a slightly more open question, and one subject to considerable debate between those who like statistics and dislike analyzers (engineers mainly), and those who do not trust anything which is not a directly traceable analytical result (chemists mainly). This leads to various approaches to APC:

**APC based on inferential models**

- Use of many basic mass-flow, pressure, and temperature transmitters
- Requires chemical engineering model of unit
- Requires lab test data to calibrate and maintain the inferential quality estimator

**APC based on physical analyzers**

- Use of many single-property physical analyzers for direct measurement
- Requires extensive maintenance, calibration, training, and spares stockholding

**APC based on Advanced Analyzers**

- Use of a smaller number of multi-stream multi-property analyzers
- Requires calibration or calibration model development
- Normally offers significant improvement in speed, precision, and reliability

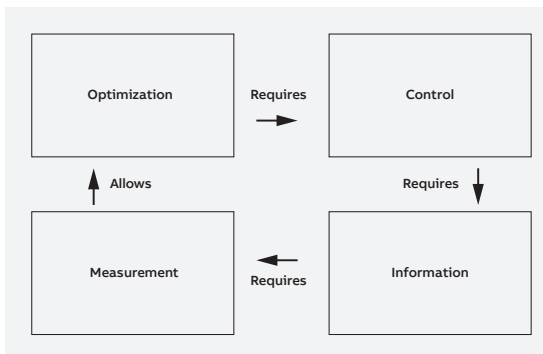

The cycle of measurement and optimization

APC based on actual process stream quality measurements from real analyzers is superficially attractive but fraught with risk.

**Historically this approach was hindered by:**

- High capital cost
- Limited reliability, high life-cycle costs
- Large infrastructural requirements for installation
- Complex operational requirements (calibration, validation)

**Technical advances have led to:**

- Wider range of available technologies
- Simpler, more robust, lower cost analyzers
- Significantly reduced installation and operational demands

The long maintenance intervals and low life-cycle costs of Fourier-Transform Near IR (FT-NIR) analyzers have offered one route to deal with part of the problem. Chosen wisely, they offer space-technology levels of reliability and uptime (quite literally because the technology is routinely used in climate sensing satellites). On-line FT-NIR analyzers now have a proven track record in reliable hydrocarbon stream property measurement across the full range of refinery and petrochemical streams from crude distillation to heavy oil upgrading, naphtha conversion, and final product blending.

In the present case, on-line process FT-NIR analyzers offer an excellent match with the measurements required for liquid naphtha feed real-time composition monitoring. On this application, they compare very favorably with process gas chromatographs which, for a full PIONA analysis, are simply too slow for effective APC update cycles in this fast-moving process. On the other hand, GCs (or process mass spectrometers) are rather well-suited to post-furnace gas effluent measurement. For a steam-cracker with a variable naphtha feed quality, or employing a recycle of C4+ back into the furnace feed, both feed quality and effluent gas composition are necessary inputs for the furnace RTO.

The main compositional measurement required for feed naphtha quality determination is PIONA (% of total paraffins, iso-paraffins, olefins, naphthenes, and aromatics). This information is provided to a part of the APC system which acts as a complete furnace simulation and yield predictor. This will typically estimate, for a given severity, the total gas-make, ethylene/propylene yield, coking index, or similarly defined parameters. Depending on the particular setup, the furnace simulator and yield estimator may require input data as a simpler reduced data set (for example – PIONA and key distillation parameters such as T05, T95), or it may require a full C-number-based breakdown of the entire hydrocarbon composition. Process FT-NIR analyzers are able to meet both of these requirements effectively. The exact choice of analyzer platform can be selected to achieve this in optimal fashion.



ABB process FT-NIR analyzer TALYS ASP400-Ex



ABB process FT-NIR analyzer FTPA2000-HP360

Both analyzer platforms indicated here are Ex zone certified, field-mountable process FT-NIR systems. The main difference is that the TALYS ASP400-Ex unit is a very compact, single-channel fiber-optic based system ideally suited to PIONA measurement with very simple installation requirements whereas the HP360 unit is an extractive system with an embedded analysis sample flow-cell. This latter arrangement does not require the use of fiber-optics and is able to deliver a very precise complete C-number breakdown of the naphtha feed composition when required by the furnace yield simulator.

**Example Naphtha feed calibration data**

Property	FTIR R	FTIR r	Range vol%	Property	FTIR R	FTIR r	Range (°C)
P%	0.74	0.14	18 - 53	IBP	2.1	0.26	21 to 105
I%	0.98	0.11	20 - 55	T10	1.2	0.17	35 to 81
O%(hi)	0.17	0.03	0 - 12	T30	1.7	0.16	44 to 93
O%(lo)	0.08	0.03	0 - 1.6	T50	2.4	0.2	50 to 125
N%	0.83	0.13	8 - 40	T70	3.3	0.31	54 to 143
A%(lo)	0.26	0.08	1 - 15	T90	4.9	0.32	67 to 165
A%(hi)	0.57	0.08	0 - 35	T95	7.7	0.48	69 to 185
C4 Total	0.17	0.09	1 - 6	FBP	10.9	0.73	76 to 225

Typical naphtha feed qualities provided by TALYS ASP400-Ex FT-NIR analyzer

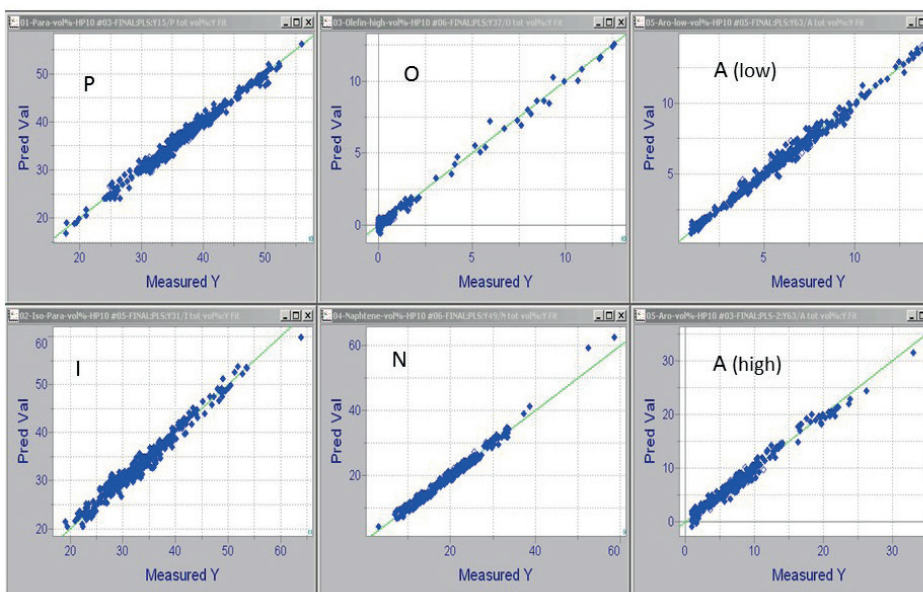

PLS Regression calibration plots for PIONA in Naphtha feed

For the FTPA2000-HP360 analyzer system, measurements are made in the 4000 to 4800 cm<sup>-1</sup> range of the NIR Combination Region. This allows for very exact isomer discrimination, hence a reliable carbon-number based breakdown of naphtha components.

For example, shown above are the spectra of different C6 isomers. The left-hand plot shows spectra of the individual compounds, which can be seen to be rather clearly differentiated in the position, shape and intensity of Near-IR Combination Region absorbance bands. The right-hand plot shows examples of gravimetrically prepared mixtures of the pure compounds. This resembles quite well a typical naphtha-type hydrocarbon spectrum.

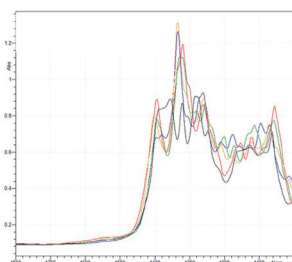

FT-NIR spectra of 2,3 dimethylbutane  
2-methylpentane  
3-methylpentane  
n-hexane  
methyl-cyclopentane

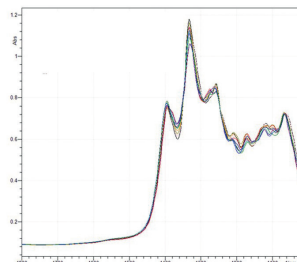

FT-NIR spectra of analysed samples for calibration set

FT-NIR spectra in the NIR combination region 4000 to 4800 cm<sup>-1</sup> for a range of C6 hydrocarbons and the associated calibration plots showing near-perfect analysis of the different C6 isomer composition.

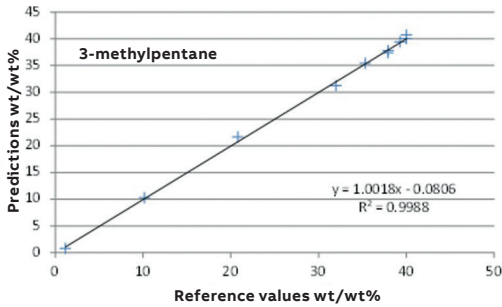
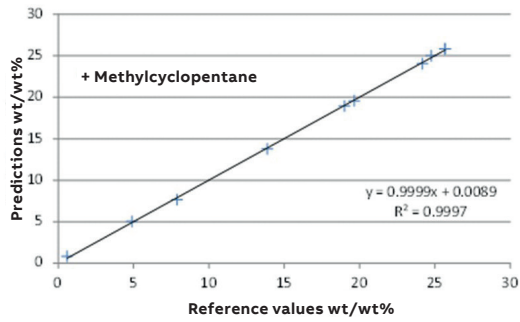
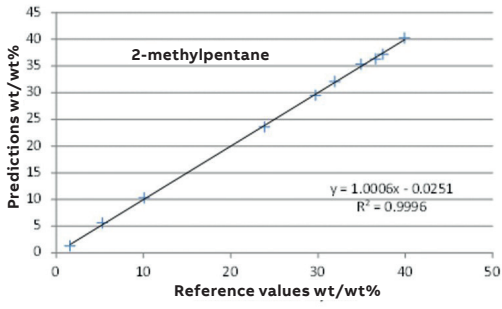

Compounds	Range (wt/wt %)	R <sup>2</sup>	Uncertainty (wt/wt %)	Repeatability (wt/wt %)
2,3 Dimethylbutane	1 - 15	0.9992	0.13	0.006
2-Methylpentane	1 - 40	0.9996	0.28	0.045
3-Methylpentane	1 - 40	0.9988	0.46	0.118
n-Hexane	1 - 30	0.9979	0.43	0.019
Methyl-cyclopentane	0.5 - 26	0.9997	0.16	0.098

Calibration plots for 2-methylpentane, methylcyclopentane and 3-methylpentane by FT-NIR analysis

The use of Fourier-transform based Near-IR analyzer platforms for this application allows choice amongst a wide range of potential Near-IR spectral regions since it is an inherent feature of this technology that it covers the entire near-infrared range from 3,700 cm<sup>-1</sup> to above 12,000 cm<sup>-1</sup> without compromise in resolution or signal-to-noise ratio. Thus, the TALYS ASP400-Ex is suitable for standard applications requiring PIONA feed to the furnace RTO and yield estimator, and the HP360 when full C-number analysis is required (for example – in a full SPYRO™ implementation).



ABB Process FT-NIR analyzer TALYS ASP400-Ex with fiber-optic link to sample flow cell cabinet

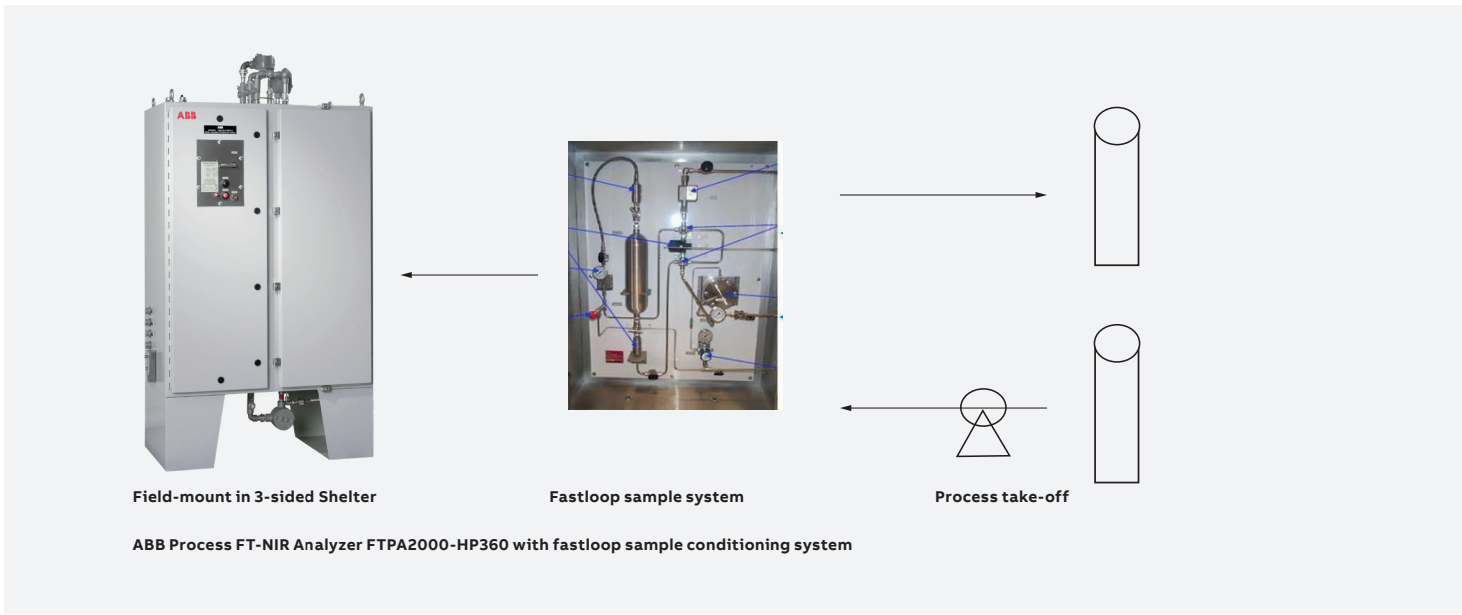

In this white paper we have reviewed the use of robust on-line process FT-NIR analyzer technologies, for the real-time analysis of liquid naphtha feed to steam-cracking units used for global scale production of ethylene and propylene. We have seen that different implementations of FT-NIR technology can be selected since the application requires full or partial feed quality characterization as feed-forward information to the cracking furnace real-time optimizer and yield estimator.

Properties including PIONA, distillation and a full C- number breakdown are available with an analysis cycle time of less than 1 minute, comparing very favorably with alternative technologies. Other on-line analyzer technologies available within ABB Measurement & Analytics with complementary application in ethylene units include process PGC5000 gas chromatographs for furnace effluent characterization and the LGR-ICOS off- axis tunable diode laser system for ultra-low level acetylene and ammonia detection in final product purified ethylene.

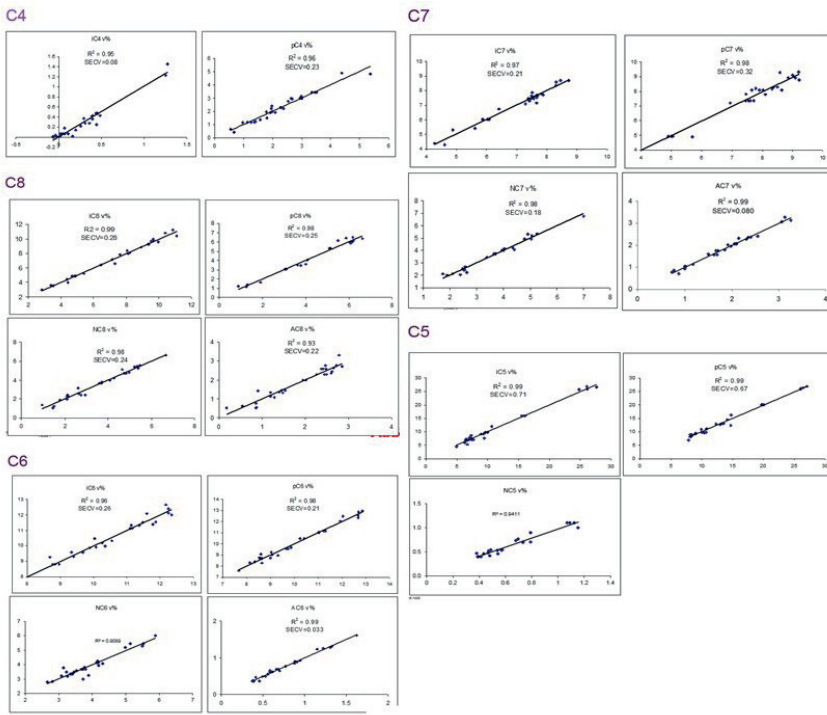

Calibration plots showing PIONA analysis by C-number for FTPA2000-HP360 system

**References**

1. Chambers, L.E.; Potter, W.S.; "Ethylene Furnace Design: Part One", Hydrocarbon Processing, p. 121, January 1974.
2. K. Keyvanloo, K.; Towfighi, J.; Sadrameli, S.M.; Mohamadizadeh, A.; "Investigating the effect of key factors, their interactions and optimization of naphtha steam cracking by statistical design of experiments", J. Anal. Appl. Pyrolysis 87, 224–230, 2010
3. Wysiekierski, A.G.; Fisher, G.; Schillmoller, C.M.; "Control coking for olefins plant", Hydrocarbon Processing, p. 97, January 1999.
4. Tecnip Engineering Solutions Briefing Note: "Steam Cracking for Ethylene Production", Paris, 2008
5. ABB Application Note, "Model Based Severity Control for Olefins Plants", PA Division, Oil Gas & Petrochemicals, 2011

—

**ABB Inc.**

**Measurement & Analytics**

3400, rue Pierre-Ardouin  
Québec (Québec) G1P 0B2  
CANADA

Tel: +1 418-877-2944

1 800 858-3847 (North America)

E-mail: [ftir@ca.abb.com](mailto:ftir@ca.abb.com)

**[abb.com/analytical](http://abb.com/analytical)**



—

We reserve the right to make technical changes or modify the contents of this document without prior notice. With regard to purchase orders, the agreed particulars shall prevail. ABB does not accept any responsibility whatsoever for potential errors or possible lack of information in this document.

We reserve all rights in this document and in the subject matter and illustrations contained therein. Any reproduction, disclosure to third parties or utilization of its contents – in whole or in parts – is forbidden without prior written consent of ABB.

© ABB 2017  
All rights reserved.