

ABB MEASUREMENT & ANALYTICS

Web tension systems

Pressductor PillowBlock load cells



Measurement made easy

Web tension systems

Quality tension measurement
for quality tension control

- Accurate
- Rugged
- Reliable

Pressductor PillowBlock load cells

Introduction

ABB's Pressductor® PillowBlock load cells are sensitive and accurate yet rugged, reliable and compact. The performance of the Pressductor PillowBlock load cells is unsurpassed for paper mill applications characterized by heavy rolls, high speeds and severe conditions – in some instances they are the only viable option. They can withstand high overloads and vibrations, and operate over a wide range of tensions.

The well-proven Pressductor load cells combined with the tension electronics, offer an easy-to-use/ user-friendly web tension measurement system with superior long term performance leading to higher productivity and product quality and higher profit for the web producer.

Reliable tension measurement

- from board to tissue
- from wire to winder

Increased process uptime

In a web process running continuously, every minute of production time is precious. Even so, no production line runs without downtime. With Pressductor PillowBlock load cells the risk of web breaks can be reduced to a minimum, thus leaving as much time as possible for real production.

Thanks to a strong and stable signal deriving from the Pillow-Block load cells, the upcoming web breaks are kept to an absolute minimum level.

Tighter product tolerances

The ability to produce web to tighter tolerances minimizes the costs associated with non-conforming web. It also increases the web producer's accessible market to include products with tighter tolerance requirements.



Pressductor PillowBlock load cells

50 years of experience

—
01–02 There is a PillowBlock load cell suitable for most web processing machinery used in the paper processing industries.

—
03 Pressductor technology: mechanical force alters magnetic field.

Minimize maintenance

Share the experience, of virtually maintenance-free load cells, with thousands of other PillowBlock users. A robust load cell design with no fragile or ageing components makes this possible.

Thanks to its robust design, the PillowBlock load cells work consistently for many years without any need for maintenance, also in the toughest paper mill applications.

Fast access to support and service

ABB provides customers with superior distinctive after sales service that really differentiates from the competition. You obtain advanced solutions to problems, service and professional consultation through our After Sales Service program. Expert engineers with extensive experience of all types of Force Measurement products are available to assist you through our world-wide network.

There is a PillowBlock load cell suitable for most web processing machinery used in the paper processing industries

In the paper industry, the PillowBlock load cells are ideal in wire, press and dryer sections as well as in coaters, calenders and winders.

In the converting industry, the PillowBlock load cells have proven their superior performance in laminator and coater machinery.

The Pressductor difference

Like ABB's other load cells based on Pressductor Technology, PillowBlock load cells rely on electromagnetic changes in the transducer, not on physical movement, to sense fluctuations in web tension. The Pressductor Technology operating principle provides exceptional improvements in load cell performance characteristics, including reliability (notably absence of drift), durability, repeatability, and wider measurement range.

Machined from a solid block of steel, the load cells are rugged and stiff, affording high overload protection as well as an extended measurement range above the nominal load. And they do not contribute to machine vibration, even at high speeds.

Since the transducer action – the magnetic flux – takes place inside a steel core, environmental factors like dirt or fluids can't degrade performance and reliability. These stainless steel load cells don't require any physical seals.

Furthermore, low transducer impedance – less than a couple of ohms – helps eliminate susceptibility to radio-frequency and electromagnetic interference.

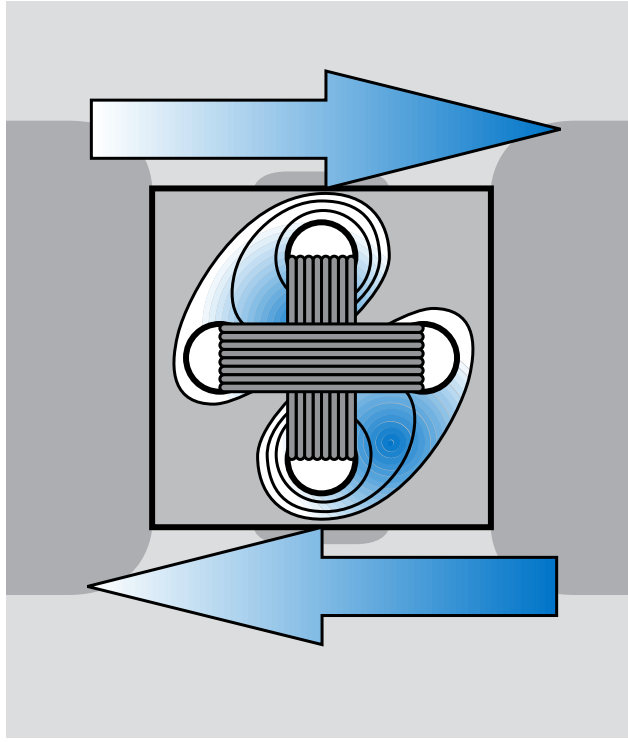
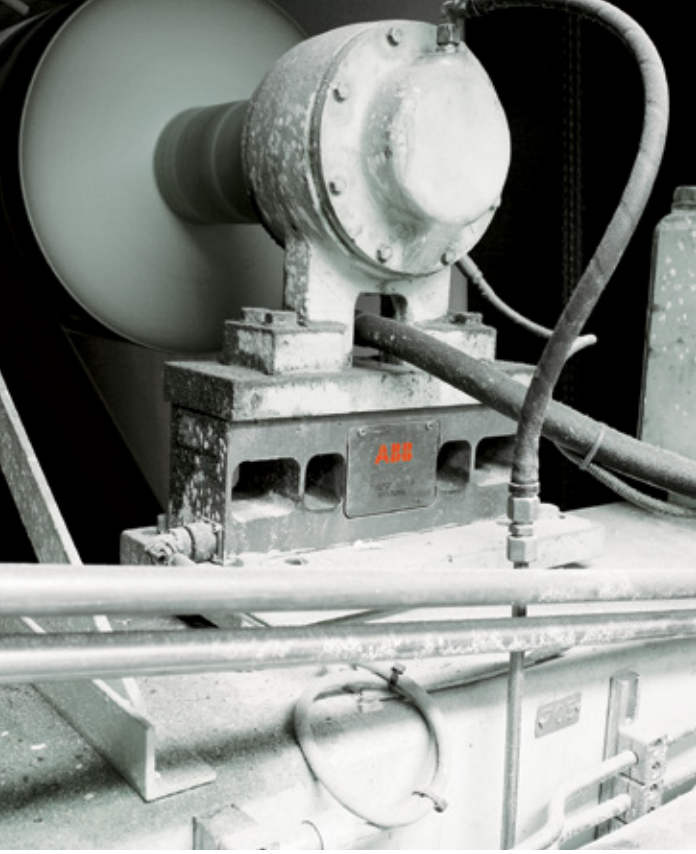

—
02

—
01



—
03

Pressductor PillowBlock load cells

Ideal for paper and converting industry

Designers appreciate:

- Remarkably high spring constant
- Wide measurement range
- High reliability

Operators value a load cell with:

- No drift
- No need for recalibration
- No failures
- High reliability

Measurement essentials

Keeping the tension constant in web processes is essential for high product quality and productivity. Continuously measuring the tension is an obvious prerequisite for tension control. Drives and operator instruments need quick and accurate input to regulate tension levels and monitor machine performance.

Most web processing lines put a premium on long-term reliability, in addition to accuracy and overall performance. The measurement system, after all, is the front line of machine control, exposed to all the rigors of the operating environment. The costs associated with down-time and poor product bring out the true value of its components.

Quality measurement technology for superior tension control that will keep your processing lines productive and producing top-notch output – that's what you can expect from us. We're entirely devoted to providing process measurement systems and services, and we have 60 years of experience in the field. We are the experts in web and strip tension as well as force measurement for virtually any purpose.

Selecting and sizing load cells

The two types of ABB PillowBlock load cells are designed for either conventional vertical force measurement or for sensing the horizontal force component that may arise as the processed material partially wraps around a measurement roll.

Using the horizontal load cells can be quite advantageous. By design, they can be made exceptionally sturdy, rugged, and stiff. So, requirements for recalibration, other maintenance, or replacement are negligible, and they do not contribute to machine vibration. Since they don't measure the tare weight, but just the horizontal force component of the web tension, they can be sized smaller than otherwise possible, measuring tension with greater accuracy.

—
01

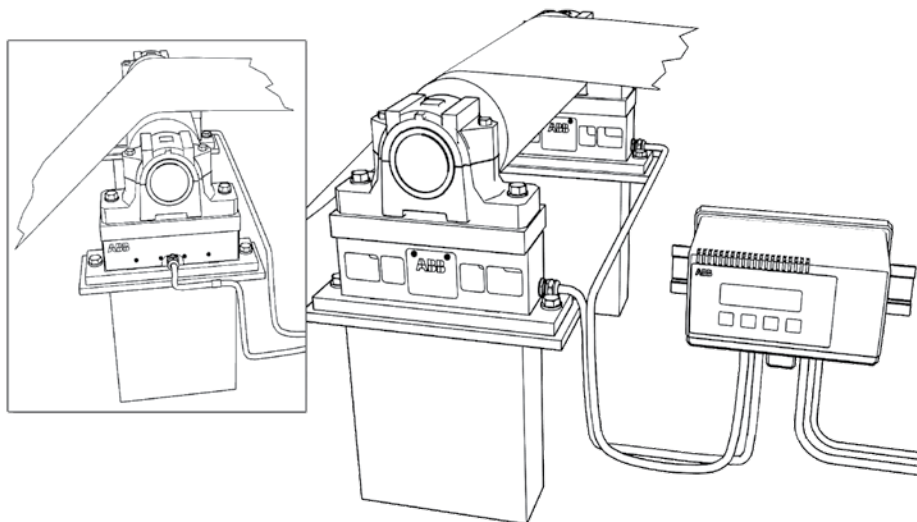

Extended-range operation

An extended range of measurement beyond the nominal load allows the PillowBlock to be sized for normal, as opposed to maximum tension levels. As a result, they permit greater application flexibility on the processing machinery.

Application requirements may dictate the selection of a vertical load cell. But whenever an adequate horizontal force component is present (or can be developed), the horizontal load cell should be considered.

The size, or nominal load, of a load cell is contingent on the anticipated force it will measure. When a vertical load cell is mounted horizontally (the most common arrangement), the measurement force (F_R) is a function of the tension in the web (T), the deflection angles (α and β), and the tare weight of the roll and bearings ($Tare$).

The horizontal load cell senses the web tension's (T) horizontal component (F_R); not the vertical force (F_V).

In this scenario, the measurement force (F_R) is a function of only the tension in the web (T) and the web angles (α and β). Since the tare force (the weight of the deflector roll and bearings) will not be measured, it can be very large compared to the web tension without affecting the accuracy of the tension measurement.

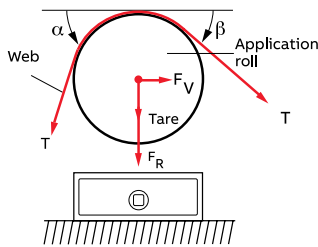

Vertical measuring load cells
 $F_{Rtot} = F_R + Tare = T(\sin\alpha + \sin\beta) + Tare$
 $F_{Vtot} = F_V = T(\cos\beta - \cos\alpha)$

- F_R = Force component of Tension in the measuring direction
- F_{Rtot} = Total force in the measuring direction
- F_V = Force component of Tension transverse to the measuring direction
- F_{Vtot} = Total force in the transverse direction
- T = Tension in web
- $Tare$ = Weight of roll and bearings
- α, β = Deflection angles

Specifying the load cell

Since load cells are typically used at both ends of a roll, rating the individual cell is usually based on half of the resultant force. The ideal load cell size is usually the smallest nominal capacity rating accommodating that force level, so long as the force exceeds 10 % of the nominal load. Before choosing a larger size, however, consider using the extended range feature of ABB load cells. And always verify that overload specifications will not be exceeded in either direction.

Application hint

Two 10 % application guidelines are useful in selecting load cell sizes:

1. The proportion of web tension that is actually sensed by the load cell should be at least 10 % of total web tension. For operational conditions producing values below 10 %, consult ABB.
2. During normal operation, the sensed force should not be less than 10 % of the load cell's capacity.

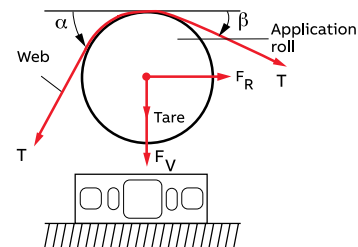

Horizontal measuring load cells
 $F_{Rtot} = F_R = T(\cos\beta - \cos\alpha)$
 $F_{Vtot} = F_V + Tare = T(\sin\beta + \sin\alpha) + Tare$

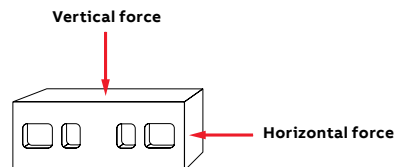

Pressductor PillowBlock load cells

PFTL 101 Horizontal force measurement, 0.5 to 20 kN

Application hint

- Horizontally measuring load cells are ideal in applications with high tare loads and relatively small tensions, such as paper machines.
- In applications where high overloads can occur in any direction, the high overload tolerance in all directions of ABB's horizontal PillowBlock load cell adds reliability.
- If no horizontal resultant force is present, mounting the load cell on a slant will give rise to one.

ABB PillowBlock horizontal load cells are ideal in applications characterized by low tension levels, heavy rolls and high operating speeds – a scenario often encountered in the paper industry.

Using the horizontal force component to measure web tension can be highly advantageous. The load cell can be sized to measure just the web tension, excluding the tare weight of the roll, which, on a big paper machine, for example, can be far greater than the tension in the web. The result is optimized measurement accuracy.

Solid stainless steel construction combines sensitivity and accuracy with exceptional ruggedness and high spring constant. The units tolerate overloads up to five times their nominal capacity, and combined with the electronics are designed to provide stable output even when subjected to intense vibration.

PFTL 101A

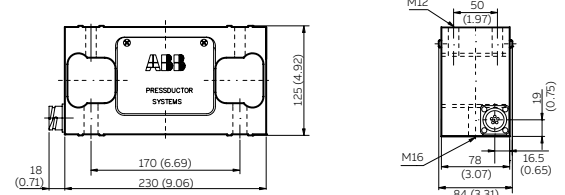

PFTL 101B

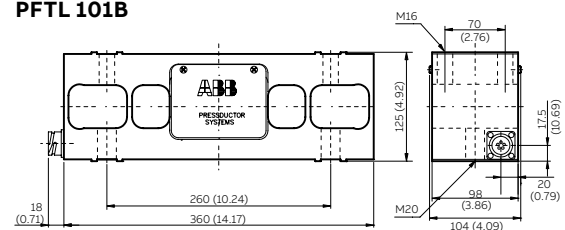

Dimensions in mm (in.)

The PillowBlock comes in three versions:

The standard version, PFTL 101A/B, is often used for accurate measurement in the paper industry, for instance paper machines, calenders, coaters and winders. Load cells are designed for demanding applications with, for instance, heavy rolls, wide tension range and high speed.

For web tension measurement in dryer sections in paper machines, the mill-duty version, PFTL 101AE/BE, is recommended. This version has a fixed connection cable and a degree of protection of IP 66¹, which provides accurate and reliable measurement with long service life.

The acid resistant version, PFTL 101AER/BER, with 20 m fixed Tefzel® insulated connection cable, is designed for the wet end of the paper machines and has a degree of protection of IP 66/67¹.

All load cells are delivered standard calibrated.

¹ According to IEC 529, EN 60-529



Technical data		PFTL 101A/AE/AER				PFTL 101B/BE/BER			
Nominal load									
- Nominal load in measuring direction	kN	0.5	1.0	2.0	2.0	5.0	10.0	20.0	
	lb.	112	225	450	450	1125	2250	4500	
- Permitted load transverse direction	kN	5.0	10.0	10.0	30.0	30.0	30.0	40.0	
	lb.	1125	2250	2250	6750	6750	6750	9000	
- Extended load in measuring direction	kN								
- Permitted load axial direction									
Overload capacity									
- Measurement direction ¹ (horizontal)	kN	2.5	5.0	10.0	10.0	25.0	50.0	80.0	
	lb.	563	1125	2250	2250	5625	11250	18000	
- Transverse direction (vertical)									
Deflection ²	mm	0.015	0.015	0.015	0.015	0.015	0.015	0.015	0.015
	1/1000 in	0.6	0.6	0.6	0.6	0.6	0.6	0.6	0.6
Spring constant	kN/mm	32	65	130	130	325	650	1300	
	1000 lb./in.	183	371	743	743	1857	3715	7430	

All load cells

Operating principle	Electromagnetic Pressductor technology	
Accuracy class ³	%	0.5
Repeatability error	%	<±0.05
Operating range	30:1	
Working temperature range	-10 to 105 °C 14 to 221 °F	
Zero point drift ⁷	%/°C	<±0.005
	%/°C	<±0.003
Sensitivity drift ⁷	%/°C	<±0.010
	%/°C	<±0.006
Standard/Mill-duty version		
Stainless steel	SIS	2383 ⁴
	DIN	X4CrNiMo165
Degree of protection	IP65 ⁵ (standard version) IP66 ⁵ (mill-duty version)	
Acid resistant version		
Stainless steel	SIS	2348 ⁶
	DIN	17440X2CrNiMo17 13 2
Degree of protection	IP67 ⁵	

¹ Maximum permitted loads without affecting load cell calibration.

² At nominal load.

³ Accuracy class is defined as the maximum deviation, and is expressed as a percentage of the sensitivity at nominal load. This includes linearity deviation, hysteresis and repeatability error.

⁴ Corrosion resistance properties similar to AISI 430F

⁵ According to IEC 529, EN 60-529

⁶ Corrosion resistance properties similar to AISI 316L

⁷ Applies for 20 to 80 °C/68 to 176 °F

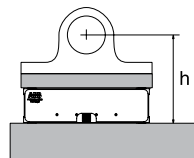

Height (h≤300 mm) from load cell's bottom surface to roll center line

Pressductor PillowBlock load cells

PFTL 201 Horizontal force measurement, 10 to 100 kN

ABB's horizontal Pressductor load cells are specifically designed for horizontal force measurement.

Key advantages:

- Smaller load cell sizes can be specified since the tare weight won't be a factor
- Inherently sturdier designs are virtually maintenance-free
- No contribution to machine vibration

In many web processes, the web tension inherently produces a horizontal force component on a roll or by design it can be made to do so. Paper machines and machinery processing plastics, foils or textiles are typical examples.

Using this horizontal force component to measure web tension can be highly advantageous. The load cell can be sized to measure just the web tension, excluding the tare weight of the roll, which, on a big paper machine, for example, can be far greater than the tension in the web. The result is optimized measurement accuracy.

Another advantage is that ABB's unique horizontal load cell – specifically designed to measure this force component – provides stiffness levels and overload tolerances in all force directions that are significantly greater than what can be achieved with vertical load cells.

PFTL 201C

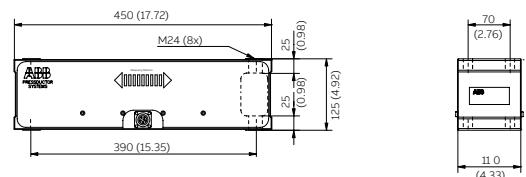

PFTL 201D

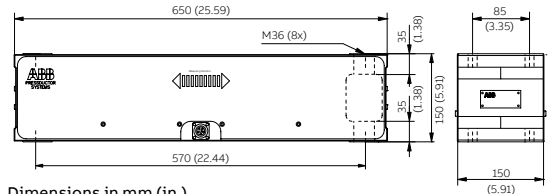

Dimensions in mm (in.)

Solid stainless steel construction combines sensitivity and accuracy with exceptional ruggedness and high spring constant. The units tolerate overloads up to ten times their nominal capacity, and combined with the electronics are designed to provide stable output even when subjected to intense vibration.

Several versions of the PFTL 201 are available:

- The standard version PFTL 201 equipped with Cannon connector for the connection cable, suitable for most applications.
- The mill-duty version PFTL 201CD equipped with a tight cable gland and 20 m fixed Tefzel® insulated connection cable, best suited for dryer sections
- The mill-duty standard version PFTL 201CE with fixed connection cable in protective hose, or with fixed Tefzel® insulated connection cable and kerosene resistant protective hose, both best for wider wire and felt tension application and larger tension in paper machines.



Technical data		PFTL 201C/CE			PFTL 201D/DE	
Nominal load						
- Nominal load in measuring direction	kN	10.0	20.0	50.0	50.0	100.0
(rated capacity)	lb.	2250	4500	11250	11250	22500
- Extended load in measuring direction ¹	kN	15.0	30.0	75.0	75.0	150.0
	lb.	3375	6750	16875	16875	33750
- Permitted load transverse direction	kN	100.0	200.0	250.0	500.0	500.0
(vertical) h=300 mm	lb.	22500	45000	112500	112500	225000
- Permitted load direction						
Overload capacity						
- Measurement direction (horizontal) ²	kN	100.0	200.0	500.0	500.0	1000.0
	lb.	22500	45000	112500	112500	225000
- Transverse direction	kN	100.0	200.0	250.0	500.0	500.0
(vertical) h=300 mm	lb.	22500	45000	56250	112500	112500
Deflection ³						
	mm	0.010	0.020	0.050	0.025	0.050
	1/1000 in.	0.4	0.8	2.0	1.0	2.0
Spring constant						
	kN/mm	1000	1000	1000	2000	2000
	1000 lb./in.	5720	5720	5720	11440	11440

All load cells		
Operating principle		Electromagnetic Pressductor Technology
Accuracy class ⁴	%	0.5
Repeatability error	%	<±0.05
Operating range		30:1
Stainless steel	SIS	2387 ⁵
	DIN	X4CrNiMo165
Working temperature range		-10 to 90 °C 14 to 194 °F
Zero point drift ⁶	%/°C	<±0.005
	%/°F	<±0.003
Sensitivity drift ⁶	%/°C	<±0.010
	%/°F	<±0.006

¹ Values indicate the total capacity of the load cells when taking into account their permissible "extended capacity". In the extended range, above the nominal load, some decline in measurement accuracy may be experienced.

² Maximum permitted loads without affecting load cell calibration.

³ At nominal load.

⁴ Accuracy class i+s defined as the maximum deviation, and is expressed as a percentage of the sensitivity at nominal load. This includes linearity deviation, hysteresis and repeatability error.

⁵ Corrosion resistance properties similar to AISI 304

⁶ Applies for 20 to 80 °C/68 to 176 °F

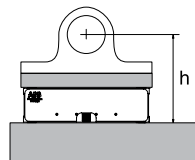

Hight (h≤300 mm)
from load cell's
bottom surface
to roll center line

Pressductor PillowBlock load cells

PFCL 201 Vertical force measurement, 5 to 50 kN

Application hint

For applications that demand vertical force measurement, the standard and mill-duty versions of ABB's vertical PillowBlock load cells provide the best in measurement range and durability.

Extended-range operation

An extended range of measurement beyond the nominal load allows ABB's PillowBlock load cells to be sized for normal, as opposed to maximum, tension levels. As a result, they permit greater application flexibility on the web processing machinery.

These units are designed for web tension measurement in applications where it is essential or advantageous to determine the vertical force component.

Machined from a single block of stainless steel, they have exceptionally high tolerance for overloads, shock and impact, in addition to high immunity to dust and corrosion.

The standard construction is of highly resistant stainless steel with potted internal components. Mill-duty versions are available for exceptionally hostile environments. They are ideal for the wet end of a paper machine.

The family of vertical load cells comprises units in four operating ranges offering measurement capacities from 5 kN (1,125 lb.) to more than 50 kN (11,250 lb.), covering applications with tensions levels in excess of 1,000 kN (225,000 lb.).

ABB's vertical load cells, like their counterparts for horizontal measurement, feature an extended operating load range. Up to 50 % more measurement capacity is available in this range with fully retained performance characteristics, except some decline in measurement accuracy.

PFTL 201C/CD

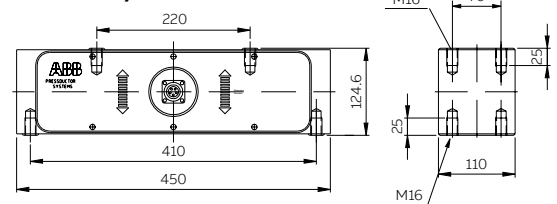

PFTL 201CE

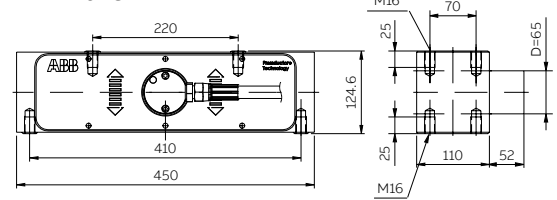

Dimensions in mm

As a result, in most applications, the load cells can safely be specified for the web's normal tension range, but still will accommodate substantial peak loads.

In fact, both types of ABB PillowBlock load cells feature an exceptionally wide measurement range.

Installation in existing equipment can be simplified by use of top and bottom adapter plates, which can be supplied by ABB.

Three versions of the PFCL 201 are available:

- The standard version PFCL 201C equipped with Cannon connector for the connection cable, suitable for most applications.
- PFCL 201CD equipped with a tight cable gland and 20 m TEFLON 1 insulated connection cable.
- The mill-duty version PFCL 201CE with fixed connection cable in protective hose, best suited for wire and felt tension applications in paper machines. Three different versions of the cable/hose are available, but the kerosene resistant version is recommended for these applications.

¹ TEFLON is a registered trademark of DuPont



Technical data		PFCL 201C/CD/CE			
Nominal load					
- Nominal load in measuring direction	kN	5.0	10.0	20.0	50.0
	lb.	1125	2250	4500	11250
- Extended load in measuring direction ¹	kN	7.5	15.0	30.0	75.0
	lb.	1688	3375	6750	16875
- Permitted load transverse direction (vertical) h=300 mm	kN	2.5	5.0	10.0	25.0
	lb.	563	1125	2250	5625
- Permitted load axial direction					
Overload capacity					
- Measurement direction (horizontal) ²	kN	50.0	100.0	200.0	500.0
	lb.	11250	22500	45000	112500
- Transverse direction (vertical) h=300 mm	kN	12.5	25.0	50.0	125.0
	lb.	2815	5625	11250	28125
Deflection ³	mm	0.02	0.02	0.02	0.02
	¹ / ₁₀₀₀ in.	0.8	0.8	0.8	0.8
Spring constant	kN/mm	250	500	1000	2500
	1000 lb./in.	1430	2860	5720	14300

All load cells		
Operating principle	Electromagnetic Pressductor Technology	
Accuracy class ⁴	%	0.5
Repeatability error	%	<±0.05
Operating range	30:1	
Stainless steel	SIS	2387 ⁵
	DIN	X4CrNiMo165
Working temperature range	-10 to 90 °C	
	14 to 194 °F	
Zero point drift ⁶	%/°C	<±0.005
	%/°F	<±0.003
Sensitivity drift ⁶	%/°C	<±0.010
	%/°F	<±0.006

¹ Values indicate the total capacity of the load cells when taking into account their permissible "extended capacity". In the extended range, above the nominal load, some decline in measurement accuracy may be experienced.

² Maximum permitted loads without affecting load cell calibration.

³ At nominal load.

⁴ Accuracy class i+s defined as the maximum deviation, and is expressed as a percentage of the sensitivity at nominal load. This includes linearity deviation, hysteresis and repeatability error.

⁵ Corrosion resistance properties similar to AISI 304

⁶ Applies for 20 to 80 °C/68 to 176 °F

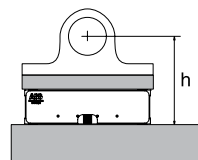

Height (h≤300 mm) from load cell's bottom surface to roll center line

Tension electronics

PFEA – the compact solution

Covering a wide range of applications, the tension electronics comes in four versions, with different levels of performance and functionality.

- 01 PFEA tension electronics.
- 02 IP20 version for control room cubicle.
- 03 Interactive display.
- 04 IP65 version for mounting on machine.

All four versions have multi-language digital display and configuration keys. The configuration keys being used for setting different parameters and to check the status of the tension system. The 2 x 16 character display can present sum, difference or individual load cell signals. All four versions are available in both DIN-rail version and enclosed IP65 ¹ version for mounting in more severe environments.

PFEA111

A cost effective, compact and user-friendly tension electronics providing an accurate and reliable fast analog SUM signal from two load cells for control and/or monitoring. The display can show the SUM, individual A & B and difference signal. The small size and DIN-rail mount make this unit very easy to integrate into many types of electrical cabinets.

PFEA112/122

These units provides the same functionality and user friendliness as the PFEA111 with the addition of fieldbus communication via PROFIBUS-DP on PFEA112, and PROFINET RT on PFEA122. On the PFEA122 it is also possible via PROFINET to access the individual A and B signals, besides the SUM signal.

PFEA113

These advanced tension electronics can supply up to four load cells and have six configurable analog out-puts for control and/or monitoring of web tension. It is possible to see both the SUM, individual A & B and difference signal, not only on the display but also on the output signals. The output signals are also available on PROFIBUS-DP.

Another useful feature is the possibility to switch the gain for two different web paths. This unit also includes a self-diagnostic function and four configurable digital outputs for alarms and level detection.

By combining up to three PFEA113, the system can handle segmented roll applications, i.e. winders, with up to 12 load cells.

The high level of functionality and user-friendliness make the PFEA113 one of the most complete tension electronics on the market.

¹ According to IEC 529, EN 60-529



—
01

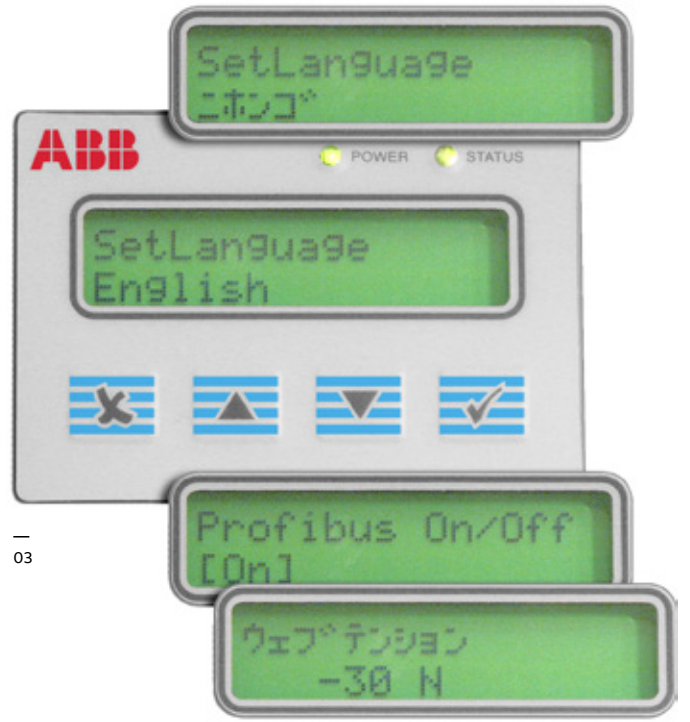

03

02



04

Features and benefits

Interactive menu

The tension electronics has a unique interactive menu which guides the commissioning step by step, eliminating the potential for making mistakes and significantly reducing startup time – a very helpful tool.

Built-in self diagnostics

The electronics continuously supervise a number of important parameters and provides error messages if something goes wrong.

Multi-language display

The multi-language display is a great feature that helps to eliminate mistakes, during start-up and/or operation of the tension system.

Load memory

The resettable load memory stores max. load values. A useful tool for maintenance.

Analog outputs

The PFEA provide a scaled and zeroed tension output ready for use in control or monitoring. Individual scaling and filtering can be done for each of the analog outputs.

PROFIBUS-DP and PROFINET

PFEA112 and PFEA113 have Fieldbus communication via PROFIBUS DP as standard. PFEA122 comes with PROFINET RT communication. Regardless of the communication protocol used, measurement values and status information will be available.

Filter function

All units come with a selectable filter function for removal of roll unbalance, machine vibrations and other disturbances.

Commissioning without calibration weights

All Pressductor load cells are standard calibrated to the same sensitivity before delivery from ABB factory. This means that the fastest and most accurate way to commission a tension system is to use a calculated value instead of using calibration weights.

Mounting

To provide flexibility of mounting, all four versions of the tension electronics are available in two mounting alternatives. For mounting on a standard DIN-rail the IP20 and for wall mounting the IP65.

Floor cubicle

Floor cubicle type MNS Select is available for housing of up to 24 pcs. of PFEA111/112/122 or 12 pcs. of PFEA113 when mounted on 19 inch plates. Exact numbers depend on the combination of different tension electronics and the number of optional units used.

Options and dimensions

Options

To meet certain special application requirements the following options are available:

Insulation amplifier PXUB 201

The insulation amplifier can be used when galvanic insulation is required for analog output signals. The insulation amplifier can be connected to all versions and PFEA113 – IP65 can hold up to four PXUB 201.

Supply voltage	24 V (20 to 253 V AC/DC)	
Current consumption	10 mA + external load	
Signal range	Input	Output
	0 to ±10 V	0 to ±10 V
	0 to ±10 V	0 to ±20 mA
	0 to 10 V	4 to 20 mA
Rated insulation voltage	600 V (basic)	

Relay board PXXB 201

PXXB 201 is DIN-rail mounted and can be mounted in the IP65 versions of the tension electronics together with the insulation amplifier. PFEA113-65 can hold up to four PXXB 201.

Supply voltage	24 V DC	
Power consumption	18 mA	
Contact data	AC	6 A at 250 V
	DC	6 A at 250 V

Power supply unit

When using the DIN-rail IP 20 version of the electronics and 24 V main supply is not available, ABB offers optional power supply units.

The compact units transform main supply from 110 to 120 V/207 to 240 V AC to 24 V DC for supply of the PFEA tension electronics.

Three power supply units with different power ratings are available. The table below indicates max. number of electronics per power supply unit.

	PFEA111/112/122	PFEA113
SD831 3 A	6	3*
SD832 5 A	12	6*
SD832 10 A	24	12*

* Supply of digital outputs are not included

PFEA111/112/122 IP20 version (unsealed)

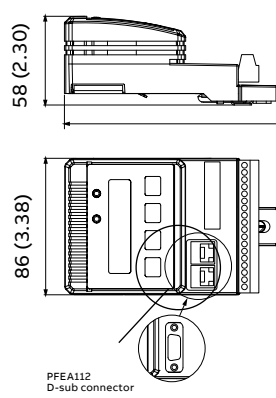

PFEA113 IP20 version (unsealed)

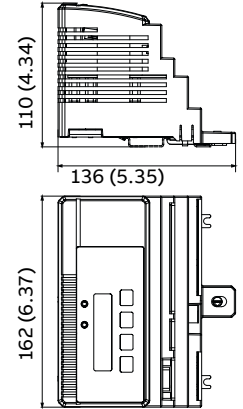

PFEA111/112/122 IP65 version

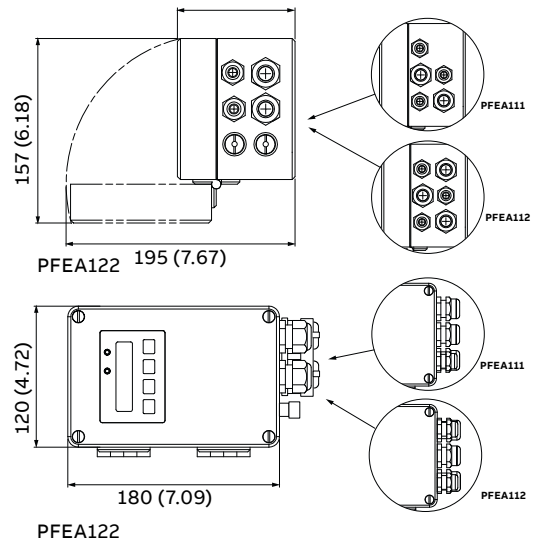

PFEA113 IP65 version

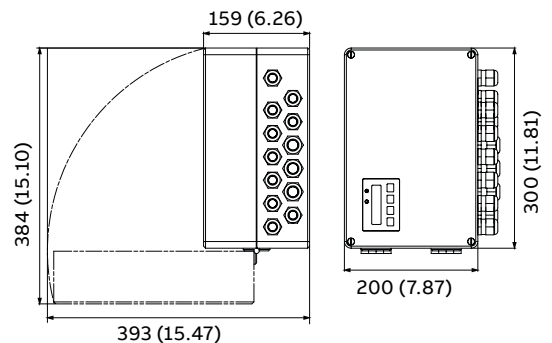

Dimensions in mm (in)

Technical data

Data	PFEA111/112/122	PFEA113
Power supply		
IP 20 voltage		24 V DC (18 to 36 V)
Power requirement	7.5 W	12 W
IP 65 main voltage	24 V DC (18 to 36 V), 100 (-15 %) to 240 (+10 %) V AC	
Frequency	45 to 65 Hz	
Number of load cells	2	4
Load cell excitation		
Current	0.5 A RMS, 330 Hz	0.5 A RMS, 330 Hz
Max. load	2 load cells plus 5 Ω cable resistance	4 load cells plus 10 Ω cable resistance
Inputs		
Digital inputs (remote zero or gain scheduling)	—	1
Analog inputs (connection of multiple PFEA113 units)	—	2
Outputs		
Analog outputs (voltage or current)	—	6
–5 to 11 V (max. load 5 mA)	1	—
0 to 21 mA (max. load 550 Ω)	1	—
Selectable filter		
Step response (0 to 90 %) can be set for each output	15, 30, 75, 250, 750, 1500 ms	5, 15, 30, 75, 250, 750, 1500 ms
Scaling function of analog outputs	Yes	Yes
Digital outputs (Status OK and/or Level detectors)	—	4
Self diagnostics, Status OK		
LED (green/red)	Yes	Yes
Alarm on Digital output	—	Yes
Alarm via PROFIBUS (for PFEA122 via PROFINET)	Yes	Yes
Multi-language interactive display ¹	Yes	Yes
Selectable tension units on the display	N, kN, kg and lbs, N/m, kN/m, kg/m, pli	
Maximum load memory	Yes	Yes
Zero offset memory	Yes	Yes
Communication		
PROFIBUS DP, baud rate up to 12 Mbit	PFEA112 (GSD-file ABB_0716.GSD) ²	PFEA113 (GSD-file ABB_0717.GSD) ²
PROFINET RT	PFEA122 (GSDML-V2.42-ABB-PFEA122-20230330.xml) ²	
Environmental tolerance		
Electrical environment		
Electrical interference environment	As per EMC Directive 2014/30/EU	
Electrical safety	As per Low Voltage Directive 2014/35/EU As per UL508 Industrial control equipment ³	
Ambient temperature	5 to 55 °C	
Degree of protection	IEC 529 Protection class IP 20 or IP 65	

¹ English, German, Italian, French, Japanese, Portuguese

² PFEA112: Sum signal, PFEA122: Sum, individual A & individual B signal, PFEA113: Sum, difference, individual A & individual B signal

³ uL508 approval available for PFEA111, PFEA113 and PFEA112 IP20



—
ABB AB

Measurement & Analytics

Force Measurement

S-721 59 Västerås, Sweden

abb.com/webtension

—
We reserve the right to make technical changes or modify the contents of this document without prior notice. With regard to purchase orders, the agreed particulars shall prevail. ABB does not accept any responsibility whatsoever for potential errors or possible lack of information in this document.

We reserve all rights in this document and in the subject matter and illustrations contained therein. Any reproduction, disclosure to third parties or utilization of its contents – in whole or in parts – is forbidden without prior written consent of ABB.

© Copyright 2024 ABB.
All rights reserved.