

# Device Management and Fieldbus

## Product Overview

### Asset Vision Professional

### DAT801

- **Integrated Extended Automation Environment:** Seamlessly integrates fieldbuses and field devices, enabling system level engineering and maintenance.
- **Freedom of Choice:** Supports a full range of FOUNDATION Fieldbus, PROFIBUS, and HART devices.
- **Information Availability:** The right information at the right time and place. All relevant device status and diagnostic information is available across the whole life cycle.
- **Plug and Produce:** Preconfigured field device objects extended with aspects to access asset information and documentation.
- **Complete Asset Optimization:** Provides a single interface for engineering and notification of plant maintenance and asset optimization information.
- **Automatic Monitoring of Maintenance Conditions:** Real-time monitoring and alarming of asset Key Performance Indicators (KPI) facilitates fast, reliable implementation of corrective actions.
- **Plant-Wide Adoption of Predictive and Proactive Maintenance Strategies:** Collects and analyzes real-time plant asset information to provide advanced warning of degrading performance and impending failure.
- **Consistent Reporting of Plant Asset Health:** Reporting features provide visualization of current health conditions via the Asset Vision Professional workplace.
- **Regulatory Enabled Calibration:** Provides 21 CFR Part 11 enabled calibration solutions with integration of Mobility Device Management Software (DMS).
- **Reduced Time to Repair via Optimized Work Processes:** Integration of computerized Maintenance Management System (CMMS) and DMS provides users with a single view, leading to an efficient maintenance response.



DAT801- Asset Vision Professional

## General

Asset Vision Professional is a software application from ABB that runs on a standalone desktop or laptop PC. Intended for engineering and maintenance personnel, Asset Vision Professional supports ABB and 3rd party devices communicating via HART, PROFIBUS, and FOUNDATION FIELDBUS. As a comprehensive asset optimization tool, it provides online and offline device configuration, parameter setting functions, online monitoring and tuning, diagnostic alerts, asset monitoring, calibration management, and integral work order processing.

HART device connection is made via point-to-point or multi-drop modem communications for offline bench parameterization and via multiplexers for online configuration and diagnostic alerts. PROFIBUS device connection is made via a point-to-point DP interface adapter for online and offline parameterization. FOUNDATION FIELDBUS connection is made via High Speed Ethernet using ABB's LD800HSE as the Link Active Scheduler supporting up to 4 H1 network segments. This connection can be used for pre-commissioning device set-up as well as for device configuration and online monitoring and diagnostics. Figure 1 shows each of these connections to a PC laptop.

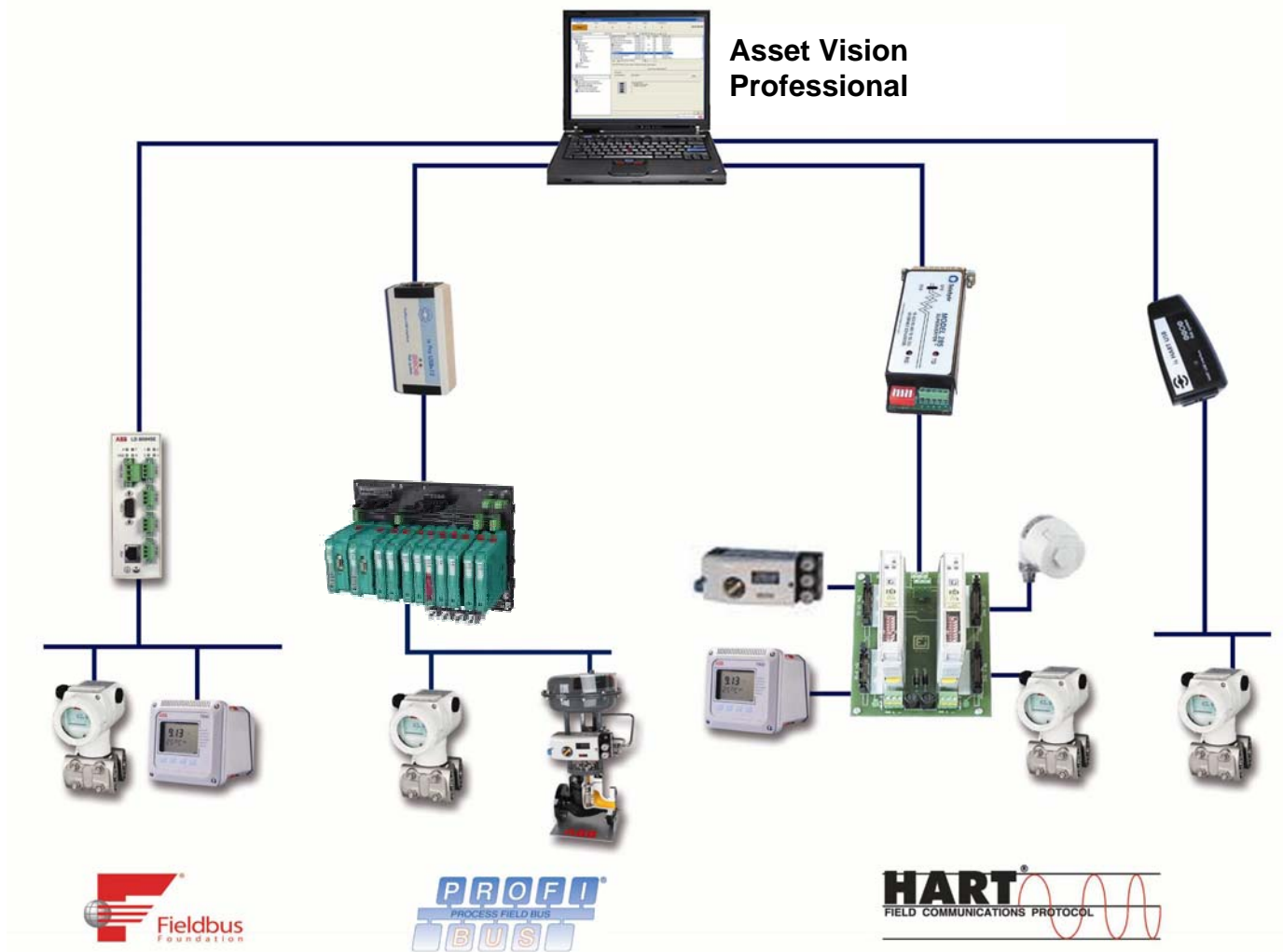

Figure 1. Asset Vision Professional Fieldbus Connections

## Product Offering

Asset Vision Professional leverages off of ABB's existing 800xA System software by re-using its powerful device management capabilities. Greater integration at the field instrument level allows customers to start with a small maintenance based application like Asset Vision Professional and grow it into a larger 800xA control system using the same configuration data and navigation methods for both. In addition to support of the 3 major fieldbuses, Asset Vision Professional supports a number of other options. Integrated calibration using the Mobility hand-held calibrator is one. Additional options for adding asset condition monitoring and CMMS interface are provided in support of asset optimization. Another option for SMS messaging to cell phones and pagers is also supported.

## Introduction

In their quest to lower lifecycle costs while improving productivity, companies have integrated intelligent field devices via fieldbus technologies into their process automation solutions. Compared to traditional 4..20 mA technology, digital fieldbus solutions integrate and exploit embedded new levels of field device information in order to streamline work processes, improve process and product quality, and maximize availability. Asset Vision Professional seamlessly integrates intelligent field devices using capabilities from 800xA Systems technology and makes the resident information available in the right manner to the right people and in the right context.

Asset Vision Professional's device management solutions result in improved engineering efficiency, reduced time for repair, and optimized plant availability and performance, ultimately leading to continuous productivity improvements. Asset Vision Professional leverages the power of industry standard fieldbuses and intelligent field devices. It lowers lifecycle costs through significant savings in the design, implementation, operation, and maintenance of field equipment.

## Integrated System Environment

With Asset Vision Professional, fieldbus topology design and field device configuration, diagnostics, performance monitoring, document management, and maintenance is performed as an integrated part of the device management environment. Through the use of context sensitive menus, Asset Vision Professional provides easy navigation through the entire project or plant, with all information available through context-sensitive menus. Device management aspects provide the means for device configuration and parameterization of up to 500 devices. Figure 2 shows an example of an Asset and Control Structure, a selected field instrument, and its associated aspects.

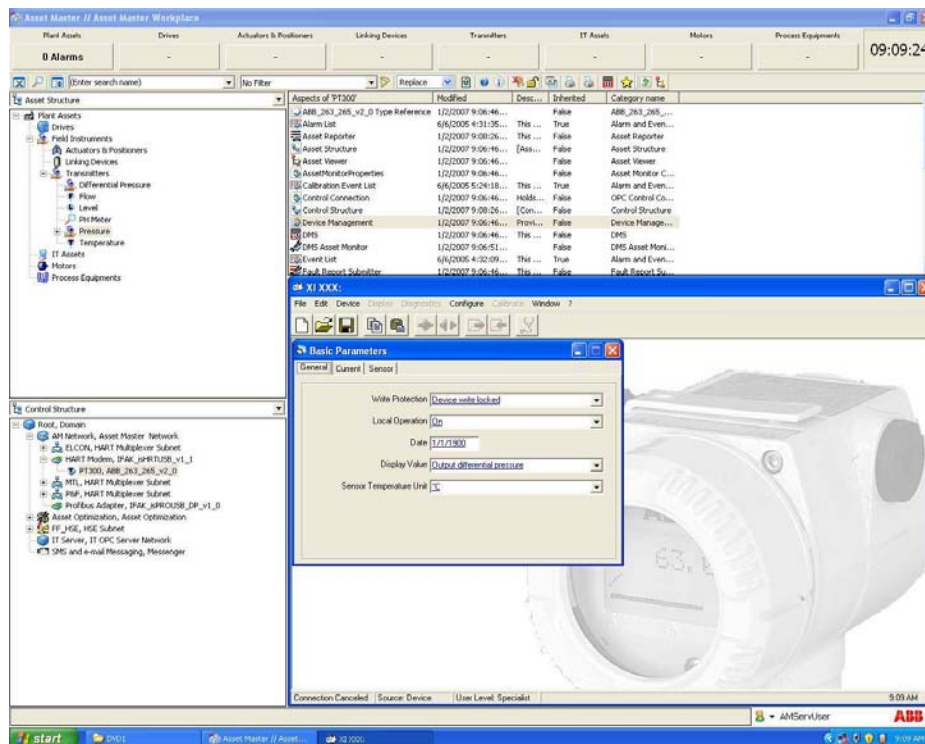

Figure 2. Field Device Planning in Asset Vision Professional

Asset Vision Professional is based on well-defined standards such as OPC and FDT (Field Device Tool), and the fieldbus protocols FOUNDATION Fieldbus and PROFIBUS. These protocols cover a broad range of applications and are widely accepted in the market. Very often regional preferences or customer specific requirements determine the decision, to which fieldbus is used. ABB's strength is to offer the freedom to choose what best fits the application needs. Asset Vision Professional also covers HART devices. Although HART is not technically a fieldbus, HART devices support access to information via digital communication superimposed to the standard 4..20mA signals. Like fieldbus data, this information is exploited by system applications.

**Configuration**

Integrated fieldbus management tools support engineers throughout the planning phase of a project. Selecting device objects from a comprehensive device integration library provides for easy configuration of network structures. The Asset Vision Professional Foundation Fieldbus management tool configures and connects distributed function blocks using application diagrams, see Figure 3. Device specific graphical user interfaces, such as DTMs (Device Type Managers), make device parameterization simple and intuitive. To assist in the engineering of large process control systems, the configuration features of Asset Vision Professional fieldbus management tool are available in both on-line and off-line modes.

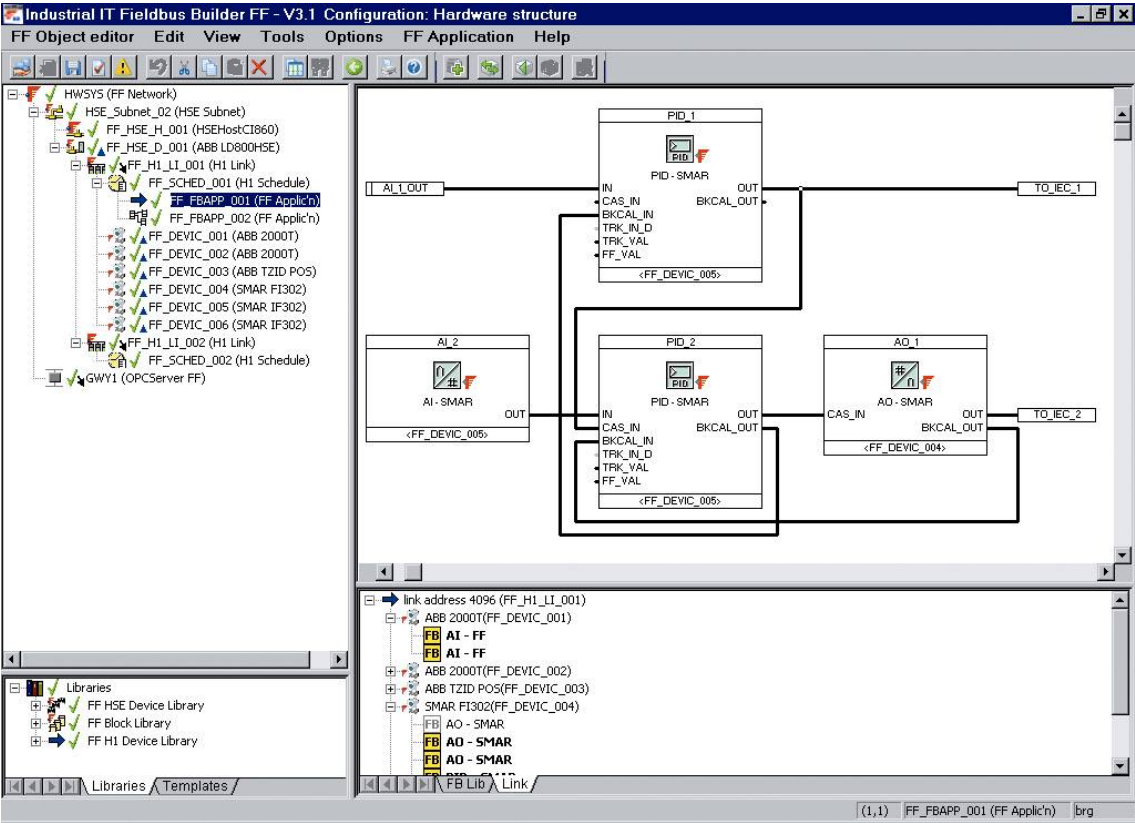

Figure 3. FOUNDATION Fieldbus application

## Commissioning

When configuration is complete, additional fieldbus management tool features support commissioning and installation of the fieldbus networks and devices. After initialization of the network, all device configurations are downloaded. Bus timing and schedule are generated automatically, while device parameters can be displayed and individually modified online. Dynamically presented in an overview display, detailed device and block status information is available on demand.

## Operation

The Asset Vision Professional Workplace is the user interface for engineers, maintenance technicians, and managers to maintain field devices, variables and status information as shown in Figure 4. In FOUNDATION Fieldbus based systems, where automation functions may be distributed across field devices, Asset Vision Professional provides a range of maintenance management views, and status displays for specific function blocks.

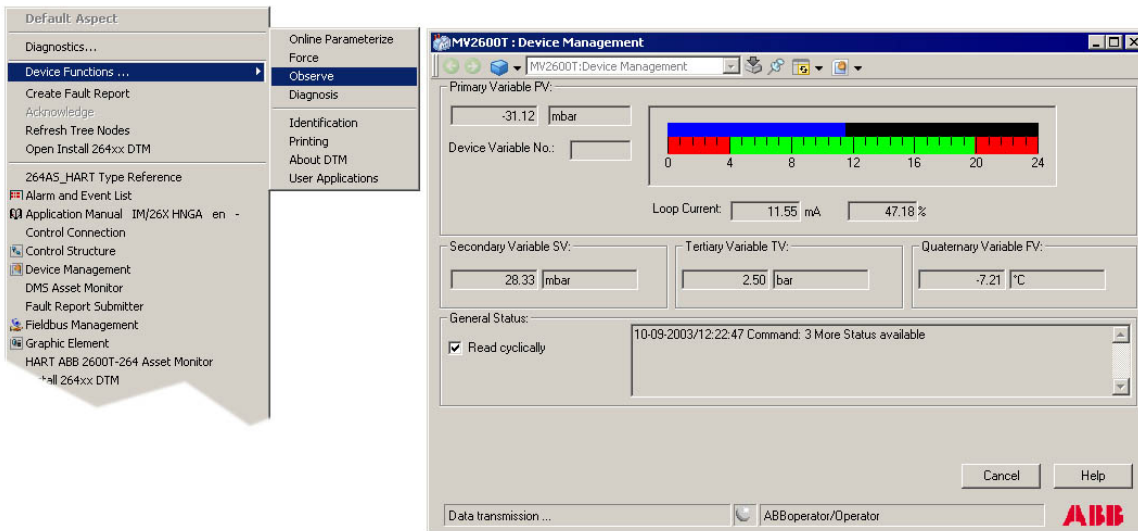

Figure 4. Monitoring of process variables

## Diagnostics

During plant operation, it is important to identify and analyze abnormal situations quickly and undertake the corresponding actions. Asset Vision Professional offers detailed diagnostic functions for communication networks and their associated field devices. Devices are monitored cyclically. The user is informed of degrading performance through Asset Vision Professional's Alarm and Events features. Detailed device status information is accessed directly from the alarm or on demand, as shown in Figure 5.

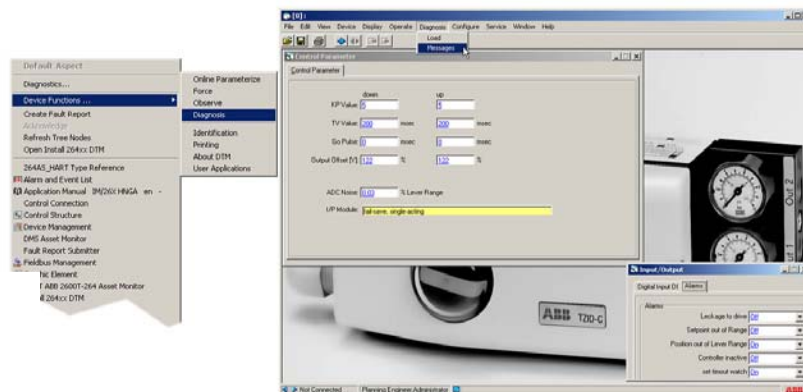

Figure 5. Example of diagnostics

## Change History

Tracking fieldbus configuration and field device parameter changes is a major requirement of the process industry. With Asset Vision Professional's audit trail mechanism, modifications like configuration upload and download, add and remove devices, and parameter changes will be recorded. By tracking these changes, configuration is kept under control and paper work is reduced.

## Real-Time Asset Optimization

During plant operation, the maintenance staff is informed about asset and device performance health and status. In the case of abnormal situations, information is reported via Asset Vision Professional alarms. In addition to presenting alarms to the system user interface, the system's SMS and email messaging service notifies key plant personnel via mobile telephones, email accounts, and pagers. Fault tracking capabilities help to find the cause of the malfunction. Comprehensive, fault reports including relevant corrective action procedures are provided and assist in root cause analysis. Additionally, the fault report can be automatically transmitted to a Computerized Maintenance Management System (CMMS) to initiate the work order process.

## Calibration

Integration of a calibration management system allows plant personnel to monitor field devices for calibration information and streamlines the maintenance workflow. Asset Vision Professional integration of calibration management systems supports:

- Calibration administration: Providing classification of devices and descriptions of general calibration procedures for different device types, calibration schedule, calibration history and reports per device and the generation of work orders and instructions for devices due for calibration.
- Calibration process in the field with a Mobility hand-held calibrator and HART communicator: Providing a device specific instruction list for calibration, logging of all executed steps and results for documentation purposes, and generation of the precise signals required to calibrate the device.

## Plug and Produce with Device Integration Packages

Asset Vision Professional offers device integration packages for each of the major field communication protocols:

- HART Device Integration
- FOUNDATION Fieldbus Device Integration
- PROFIBUS Device Integration

Each device integration package contains three components necessary to manage a field device in the Asset Vision Professional environment:

- Field device integration library consisting of ABB and third-party device type objects
- Fieldbus management tool for configuration, parameterization, commissioning and detailed diagnosis
- Fieldbus OPC server providing field device variables and status information to asset optimization applications and operator workplaces

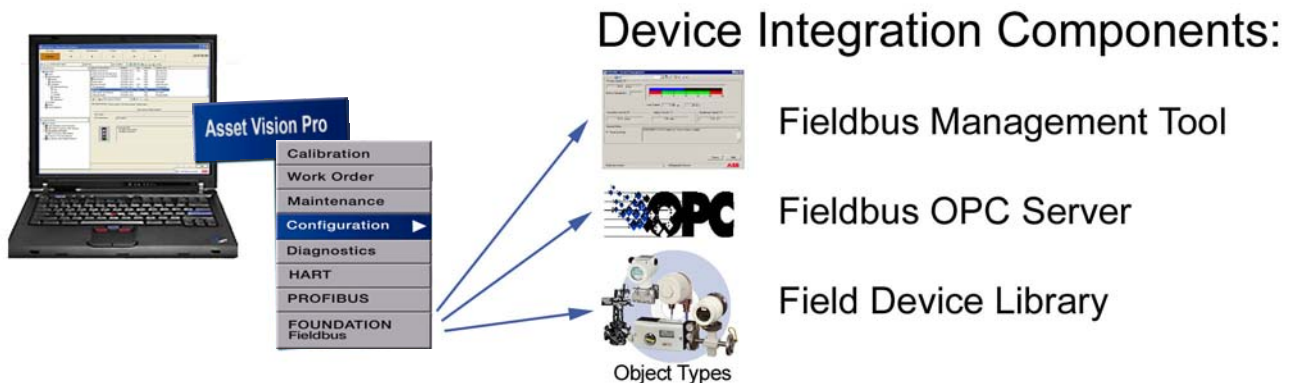

Figure 6. Device Integration Package

## Device Integration Library

The device integration library contains a large portfolio of tested and certified ABB and third-party device objects. Therefore the effort to integrate field devices is minimized. See section “Instruments Tested and Certified” for further details.

Each Device Integration package supports the user during the entire device lifecycle, from the design phase to operation and maintenance. The devices included in the library contain all the aspects required for field device management, including:

- Configuration/parameterization
- Commissioning/diagnostics
- Asset monitoring/analysis
- Maintenance management (CMMS connectivity)
- Monitoring and operation of device functions
- Device documentation access

Additional fieldbus protocol specific features are supported, see the respective section in this document.

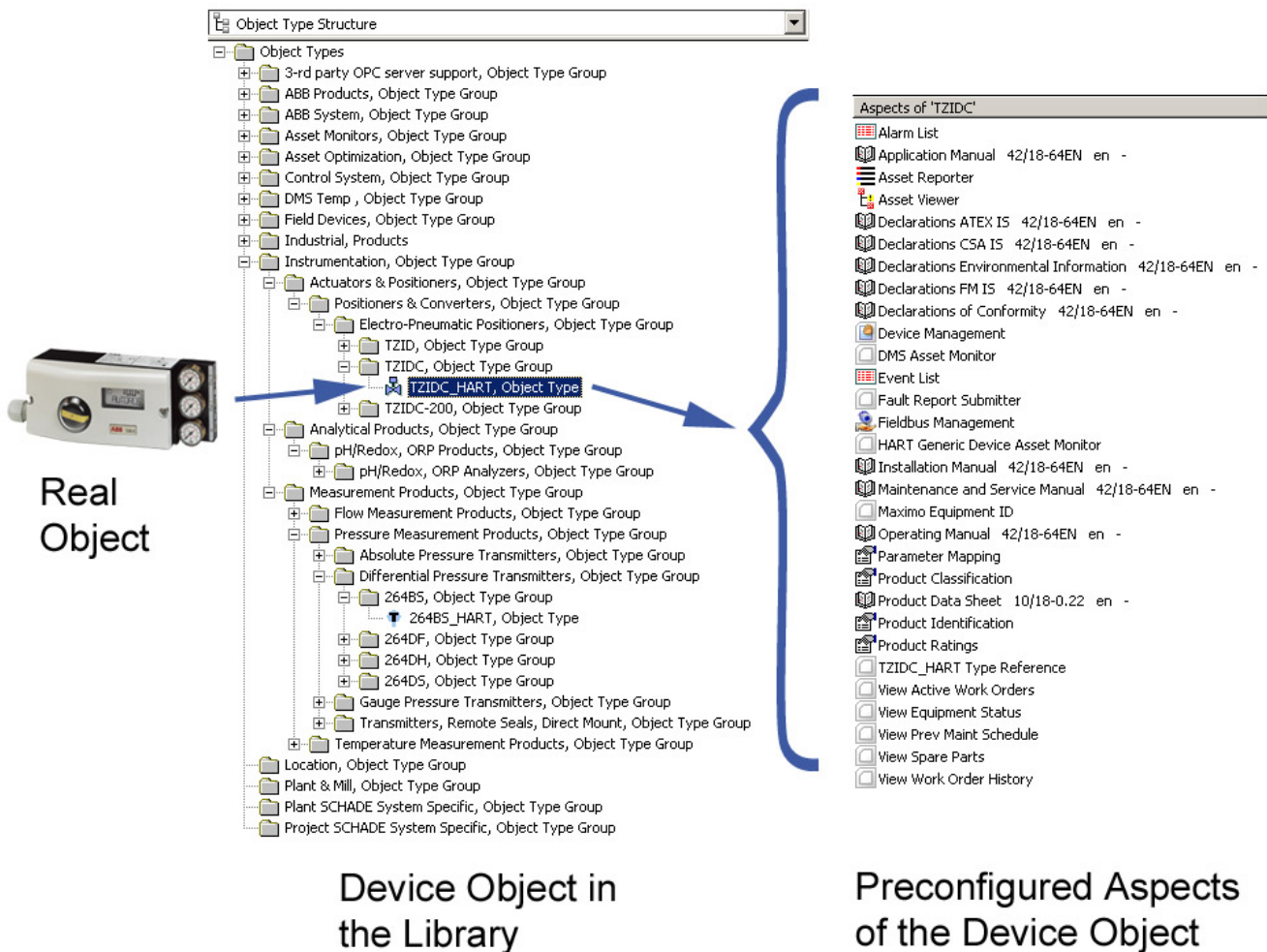

Figure 7. Device Integration Library with device object types

## Fieldbus Management Tool

Fieldbus management tools for HART, FOUNDATION Fieldbus and PROFIBUS provide the Asset Vision Professional application with the tools to engineer the fieldbus topology down to the field devices, including device parameterization, application planning, commissioning, and detailed diagnostics. The functionality is available both in online and offline modes.

Asset Vision Professional's device integration packages are based on open standards:

- Device Descriptions and Capability Files are used for FOUNDATION Fieldbus devices
- FDT is the open interface to integrate HART and PROFIBUS devices.

## FDT Technology

FDT provides for efficient use of a field device's additional information throughout Asset Vision Professional, in areas such as operation, monitoring, maintenance, diagnostics and engineering. This is achieved through the specific field device type DTM.

The DTM is the configuration and management software component for a field device. It is familiar with all of the device's rules to ensure the correctness of the device configuration. The DTM contains graphical user dialogs essential for device configuration, parameterization, diagnostics, and maintenance and enables offline engineering without requiring the connected field devices. In addition, online engineering with connected field devices is also possible.

DTMs offer advantages for both simple and advanced field devices. DTMs check the consistency of parameter data entered by a user, and the intuitive user interface of a DTM ensures higher engineering efficiency. DTMs are available for PROFIBUS and HART devices. FF field devices are integrated via capability files and DDs, which is the standard procedure for FF.

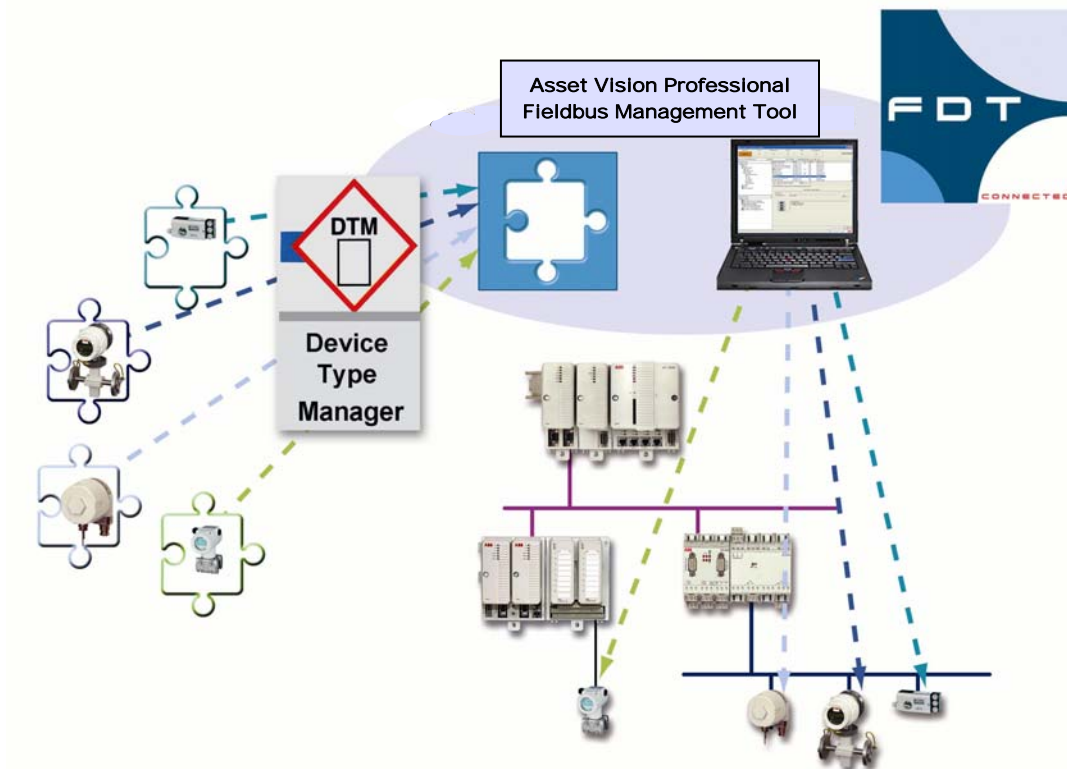



**Figure 8.** Efficient field device engineering with FDT/DTM

Another user advantage is realized when FDT technology is used in combination with the Aspect Object architecture. Without requiring additional engineering, the user can access vendor specific DTM displays from simple context menu navigation.

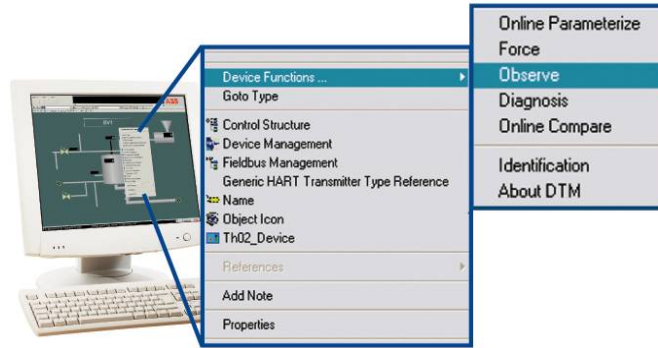

**Figure 9.** Access of DTM displays via context menus

### Fieldbus OPC Server

OPC is an open, standardized interface for process control based on Windows technology. Device Management OPC Servers for HART and FOUNDATION Fieldbus are integrated within Asset Vision Professional for their respective Device Integration Package. They enable access to field device data, device status, and diagnostic information. The information is routed through Asset Vision Professional. The Fieldbus OPC Server is dedicated for asset optimization purposes. Additional configuration effort is not required as the OPC servers are supported through the fieldbus management tool.

## Instruments Tested and Certified

Fieldbus products certified for use with Asset Vision Professional are included in the Device Integration Libraries. This paves the way for smooth device integration. On a continuous basis, the Device Integration Library is extended with devices from ABB and different manufacturers. If specific devices of interest are not included in the existing library, they can be tested and certified upon request to the ABB Device Integration Center (DIC). For the latest available list of integrated devices, please visit the ABB website (<http://www.abb.com/controlsystems>; see System 800xA -> Device Management -> Device Integration Center).

Testing and certification at the ABB Device Integration Center means more than proving interoperability. It means that each successfully integrated device will contain all of the properties described in this document, such as asset monitors, DTMs or faceplates, and device documentation.

## Device Integration Packages and Network Components

### HART Device Integration

HART field communications protocol is widely accepted in the industry as a standard for digitally enhanced 4..20mA communications with smart field instruments. A wide range of products is available today in the marketplace. HART preserves the 4-20 mA signal and enables two-way digital communications to occur without disturbing the integrity of the 4-20mA signal. The HART protocol is field proven, simple to implement, use and maintain.

HART field devices are connected to Asset Vision Professional via HART modems and HART Multiplexers. This arrangement is further described later in this section.

HART Configuration: HART field devices are configured using the fieldbus management tool for PROFIBUS/HART. The tool allows device access to Asset Vision Professional without requiring separate service bus wiring costs.

The main tasks are:

- Managing (add, move, remove, or copy) HART devices connected to modems and multiplexers
- DTM call up from Asset Vision Professional
- Comparison of field device on- and off-line data
- Upload, download and commissioning
- Configuration of the Fieldbus OPC Server

With these fieldbus management tools, the user has the capability to configure HART field devices from each Asset Vision Professional using FDT/DTM technology.

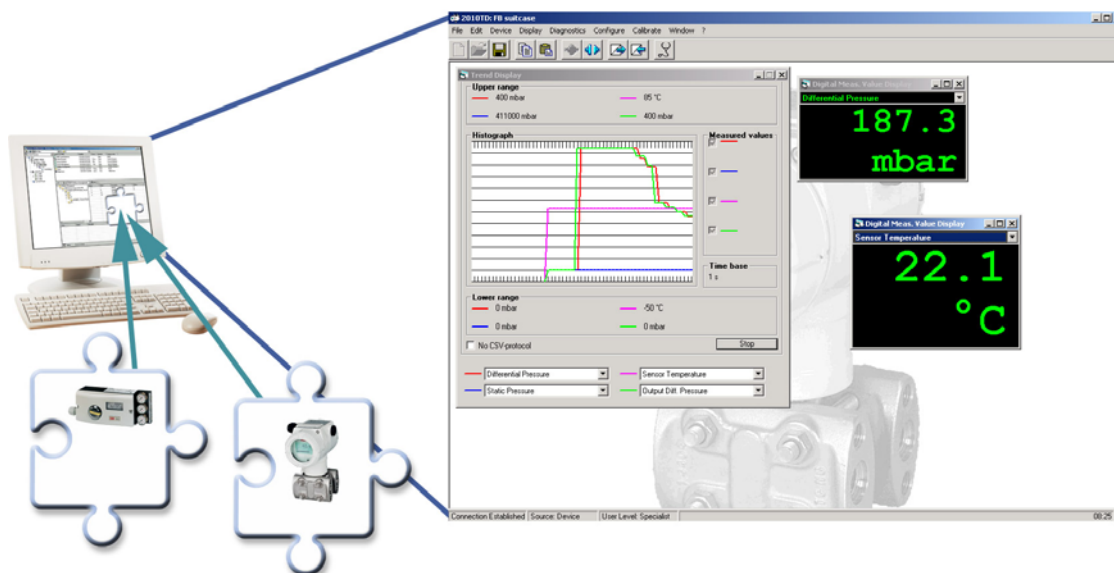

Figure 10. Configuration of HART devices

**HART OPC Server:** The OPC Server HART has been designed specifically for Asset Vision Professional and System 800xA. Included as part of the HART Multiplexer interface, it enables access to HART field device data. This means that business level applications accessible from Asset Vision Professional can access connected field device data. In connection with Asset Monitors, the Fieldbus OPC Server is used to access specific field device data, device status, and diagnostic data to make necessary informed maintenance decisions.

**Field Device Library:** The HART Field Device Library contains ABB and third party field device objects enhanced with the essential Aspects for:

- Configuration
- Parameterization
- Commissioning/Diagnostics
- Asset monitoring
- Calibration management (CMMS connectivity)
- Device documentation

OPC connectivity is prepared for all field device objects included in the field device library.

**Basic HART DTM:** When device specific DTMs are not available, the Basic HART DTM is used for basic configuration and parameterization of HART devices by means of standardized Universal and Common Practice HART Commands. If preconfigured HART devices are used, this functionality is sufficient to commission a wide range of available HART devices. The Basic HART DTM also allows reading of additional process variables and diagnostics information of HART devices. In addition, it can force the device's output to constant current mode, for simulating a certain measurement value. All devices using the Basic HART DTM are presented with the same look and feel.

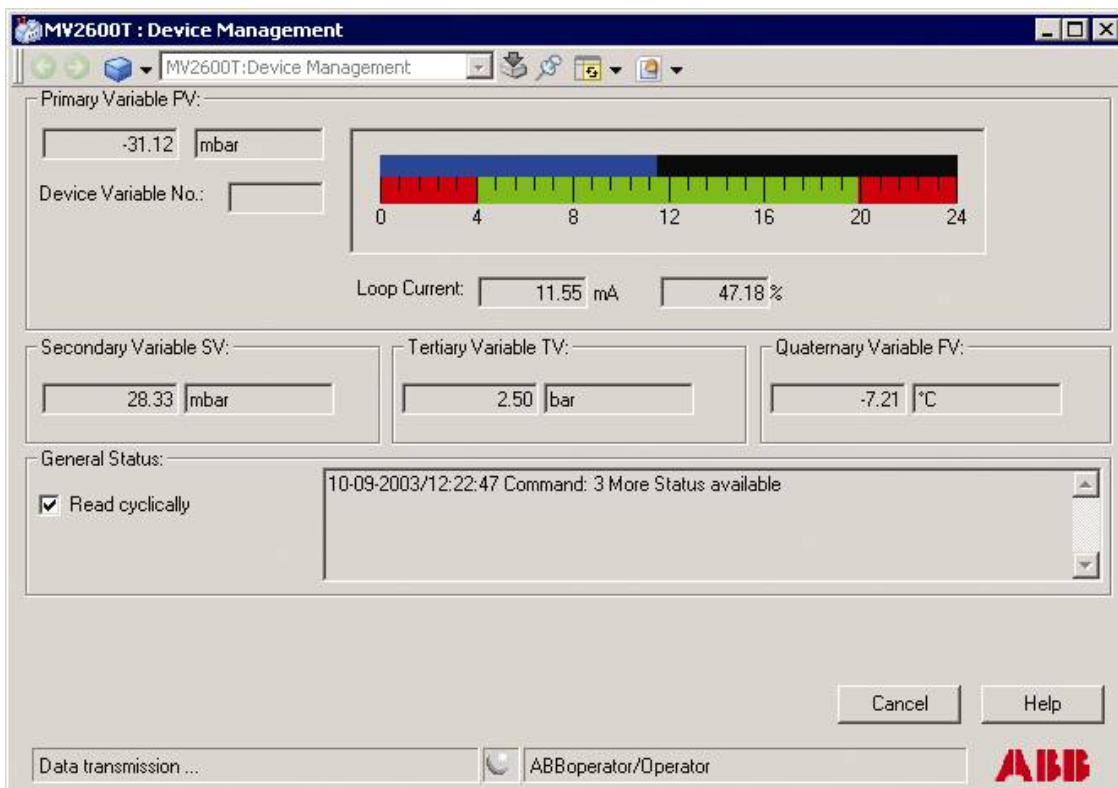

Figure 11. Basic HART DTM

**HART Modem Communication Interface:** A HART modem supports point-to-point communications or multi-drop connection with up to 15 HART devices. The HART modem connects to the PC running Asset Vision Professional via USB and to the HART device via adapter clips.

**HART Multiplexer Connect:** HART Multiplexer Connect is used to integrate HART devices from systems, such as traditional DCS, that do not allow direct access to specific HART data. HART Multiplexer Connect integrates multiplexer specific DTMs, OPC communication components, and HART multiplexer networks with Asset Vision Professional. Standard HART multiplexer hardware can be used. As a result, the benefits of the HART Device Integration Library and its aspect functionality can be fully implemented.

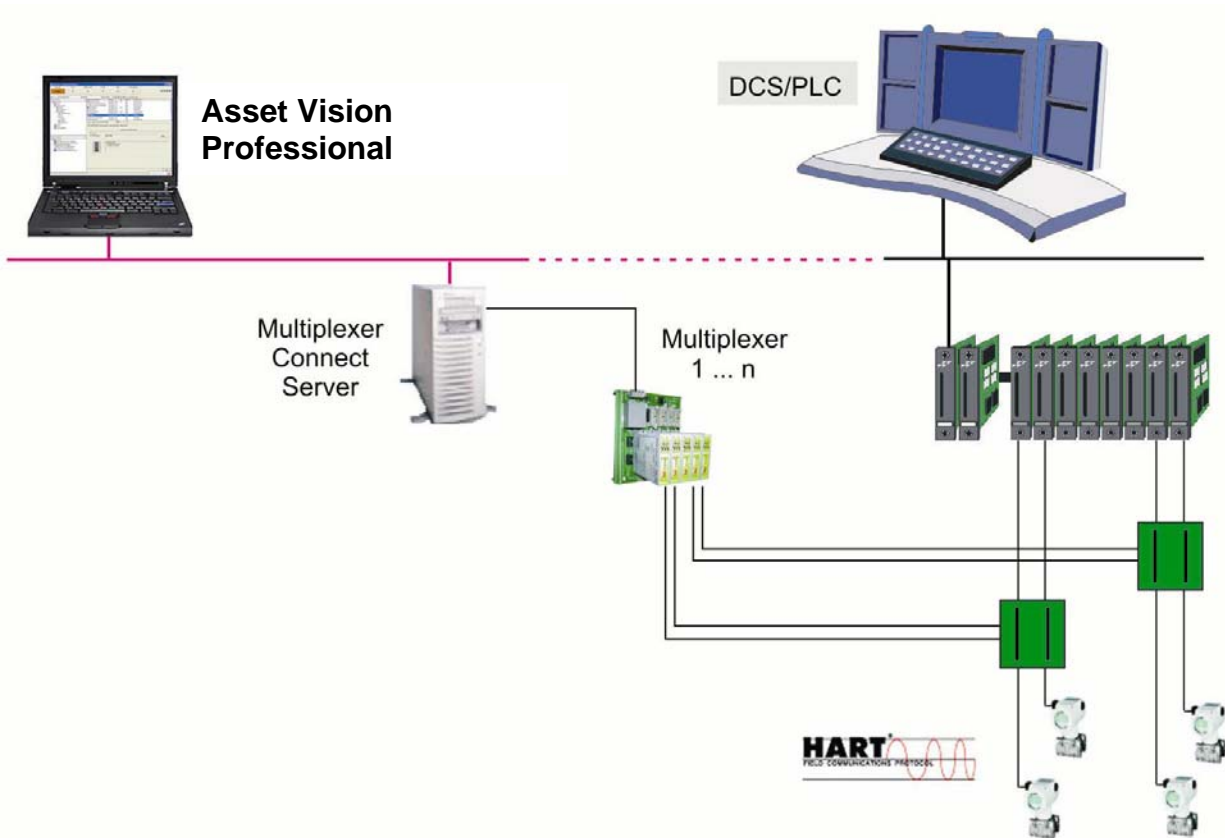

Figure 12. Example of a HART Multiplexer system topology

## FOUNDATION Fieldbus Device Integration

FOUNDATION Fieldbus (FF) is an open, integrated architecture for distribution of control applications across the network and devices. It provides an open standard for process automation applications and is supported by the major control and process automation product manufacturers. FF is an all-digital, serial, two-way communication system.

Two different fieldbus networks are supported:

- H1 link with 31.25 kbit/s designed for connection of 2-wire field devices such as transmitters, actuators and I/O including intrinsically safe applications
- HSE, the High Speed Ethernet bus with 100 Mbit/s, for optimized network design and integration of controllers, H1 subsystems via linking devices, data servers, and workstations.

ABB offers a complete FOUNDATION Fieldbus solution, containing engineering software and fieldbus infrastructure hardware. Asset Vision Professional supports the entire FOUNDATION Fieldbus architecture including High Speed Ethernet (HSE):

- H1 subsystems are linked to the HSE subnets through the optionally redundant LD 800HSE Linking Device
- Applications such as Asset Vision Professional are connected via the FF OPC Server

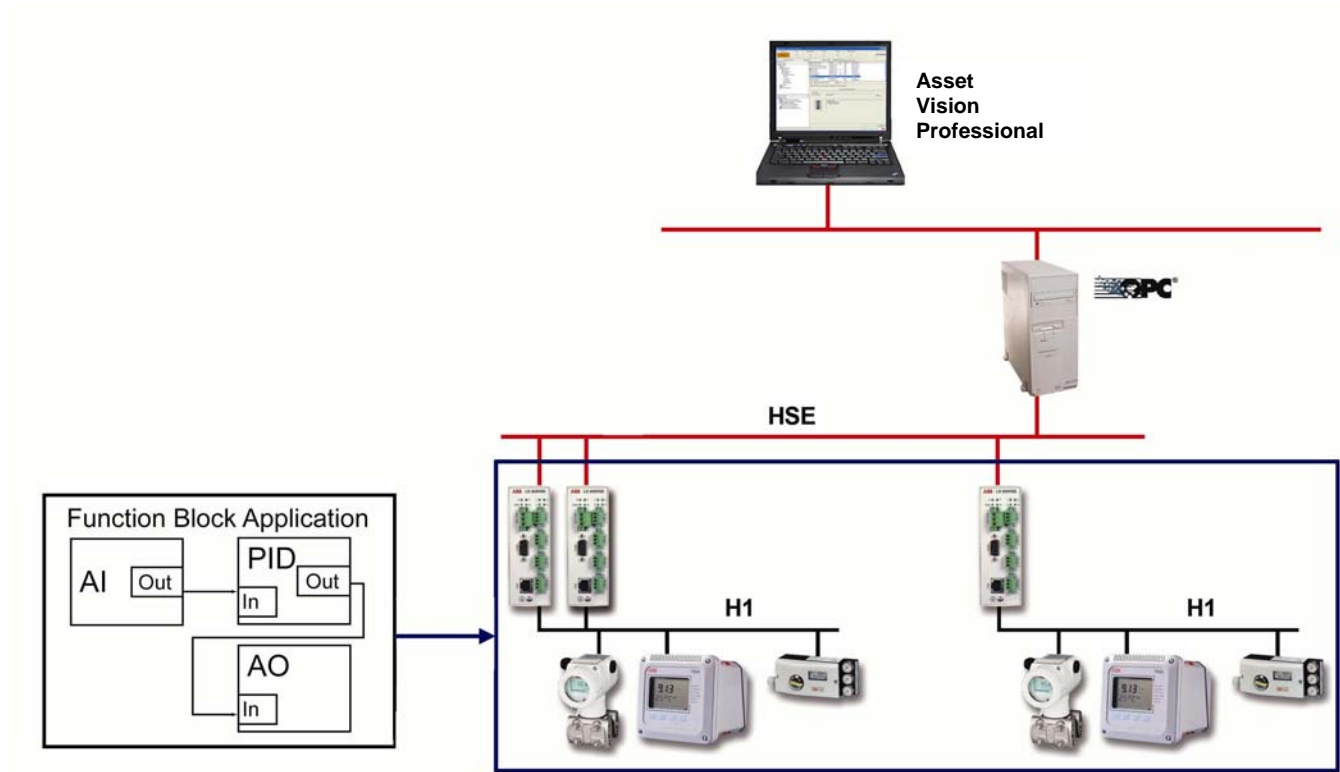

Figure 13. FOUNDATION Fieldbus solution

**HSE/H1 Linking Device LD 800HSE:** The ABB FF linking device LD 800HSE acts as a gateway between the H1 links and the HSE subnet. It provides four separate H1 links with independent Link Active Schedulers (LAS) for each H1 link. It supports the standard FF-HSE protocol and can be deployed in redundant mode by using two LD800HSE linking devices.

In addition to supporting standalone FOUNDATION Fieldbus control strategies implemented without a controller, the linking device enables design of control strategies distributed between a controller and field devices or even between field devices on different H1 links, where input and output signals are located on different H1 links. Figure 12 shows an example where signals are distributed on H1 links associated with the same linking device (publish/subscribe) or where they are passed over HSE to H1 links associated with other linking devices (republishing).

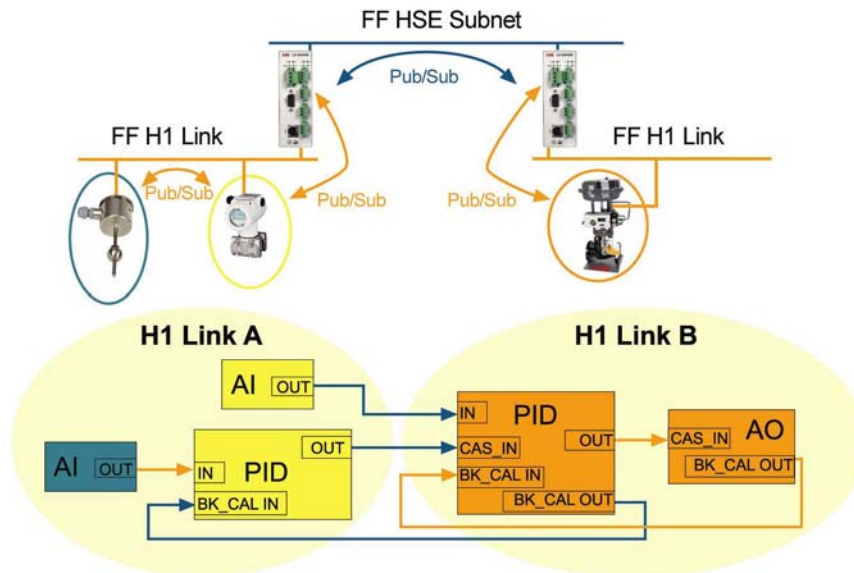

Figure 14. Communication relationship on different H1 links and different HSE linking devices

**FOUNDATION Fieldbus Management Tool:** The configuration of the FOUNDATION Fieldbus application is performed with the FF fieldbus management tool, which fully integrates the fieldbus topology planning, application configuration, parameterization, commissioning, operation and diagnostics for the entire FF network with HSE subnets and H1 links.

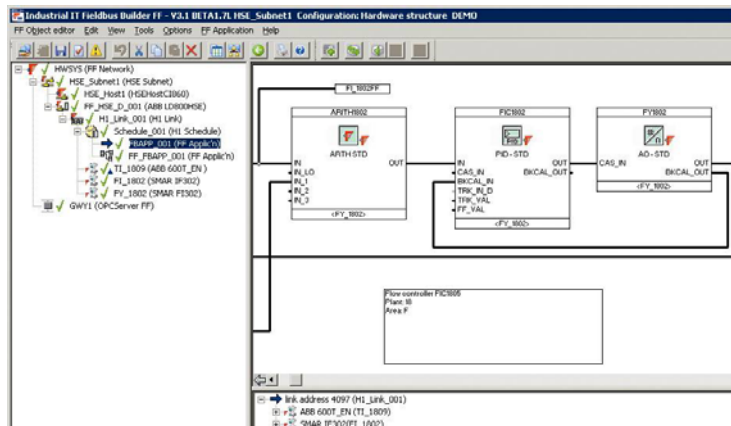

Figure 15. FOUNDATION Fieldbus Application Diagram Editor

Function block application diagrams are used to specify the distributed control functions and can be created via drag & drop mechanisms out of the FF Field Device Library. The available function blocks of each device are listed and ready for use. The function block interconnections represent signals that are published on the HSE subnet and/or H1 links. The schedule of the H1 LAS is generated automatically with the ability for manual modifications. Using the field devices corresponding FF device descriptions and capabilities files, these engineering tasks can be performed without having an online connection to the specific device.

Plausibility checks and automatic link setting optimization ensure the correctness of the network and application configuration. Early verification significantly simplifies subsequent configuration download to the field devices. Parameters and signal values, including status, can be displayed for each device and its function blocks, transducer blocks and resource blocks for diagnostic purposes.

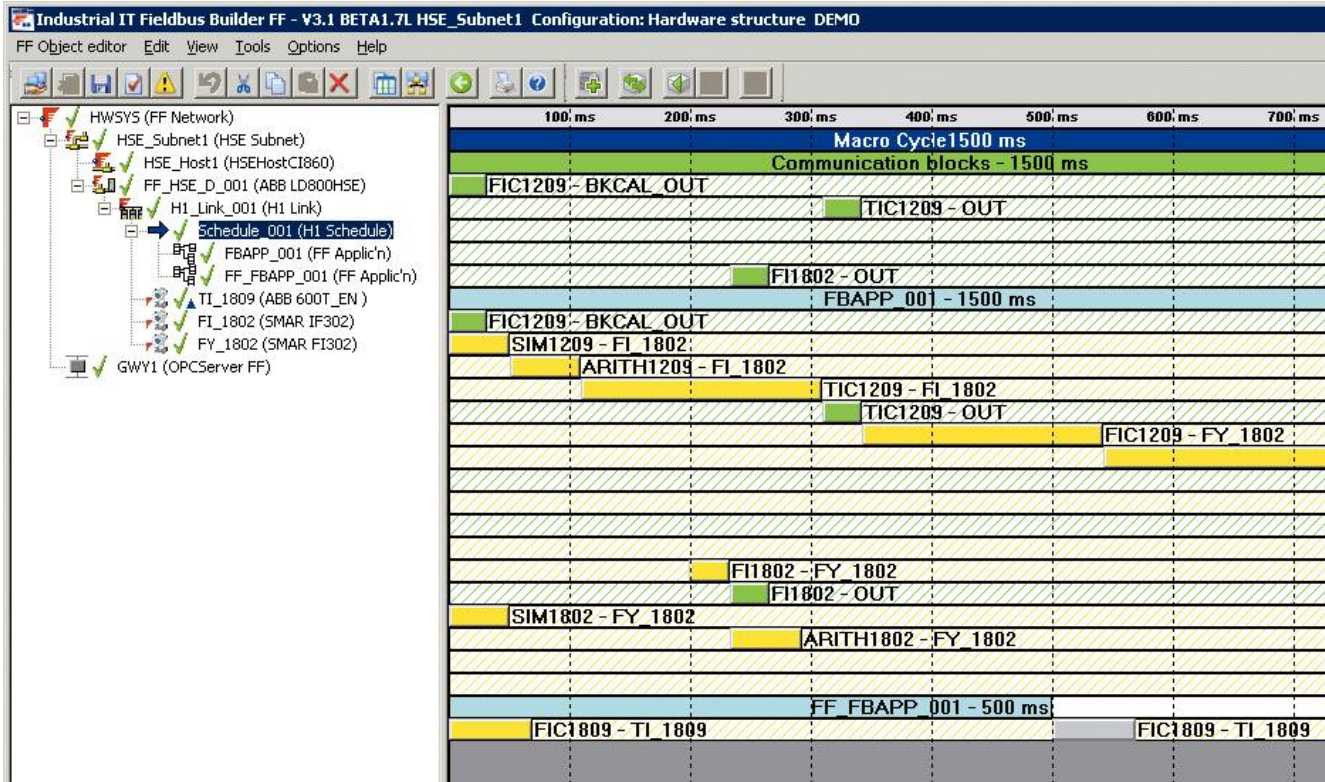

Figure 16. FOUNDATION Fieldbus scheduling

By means of creation and reuse of templates, engineering efficiency is further improved and cost minimized. Templates can be built for a single function block application or for an entire H1 link with multiple function block application and devices and re-instantiated. Parameter and signal values with status can be displayed for each device and its function, transducer, and resource block. The parameter dialogs are adapted for efficient engineering and commissioning. The FF fieldbus management tool is part of the FOUNDATION Fieldbus Device Integration package.

**FOUNDATION Fieldbus OPC Server:** The OPC Server FOUNDATION Fieldbus makes data available from FOUNDATION Fieldbus devices to any desired OPC Client. As a result visualization packages which have an OPC Client interface, such as Asset Vision Professional or other HMI applications including System 800xA, can access the data of the connected field devices. The OPC Server is configured automatically from the FF fieldbus management tool.

### PROFIBUS Device Integration

PROFIBUS is an international standardized communication protocol for the manufacturing and process industries. Within PROFIBUS, two different fieldbus types are supported for Asset Vision Professional:

- PROFIBUS DP, with scalable transmission rates up to 12 Mbit/s, optimized for interaction with devices such as remote I/O, drives or motor controllers.
- PROFIBUS PA, with a fixed transmission rate of 31.25 kbit/s, designed for connection of bus-powered two-wire field devices such as transmitters and actuators. It can be also applied to intrinsically safe applications. ABB offers a complete PROFIBUS solution, containing engineering software and fieldbus infrastructure hardware.

Asset Vision Professional supports the following PROFIBUS connection architecture:

- PROFIBUS DP interface adapter is connected via USB to the PC running Asset Vision Professional and to the PROFIBUS DP network via a standard 9 pin PROFIBUS DP connector
- PROFIBUS PA segments are linked to the DP subnet through SK3 Power Hub
- Applications like Asset Vision Professional are connected via the DP interface adapter's DTM.

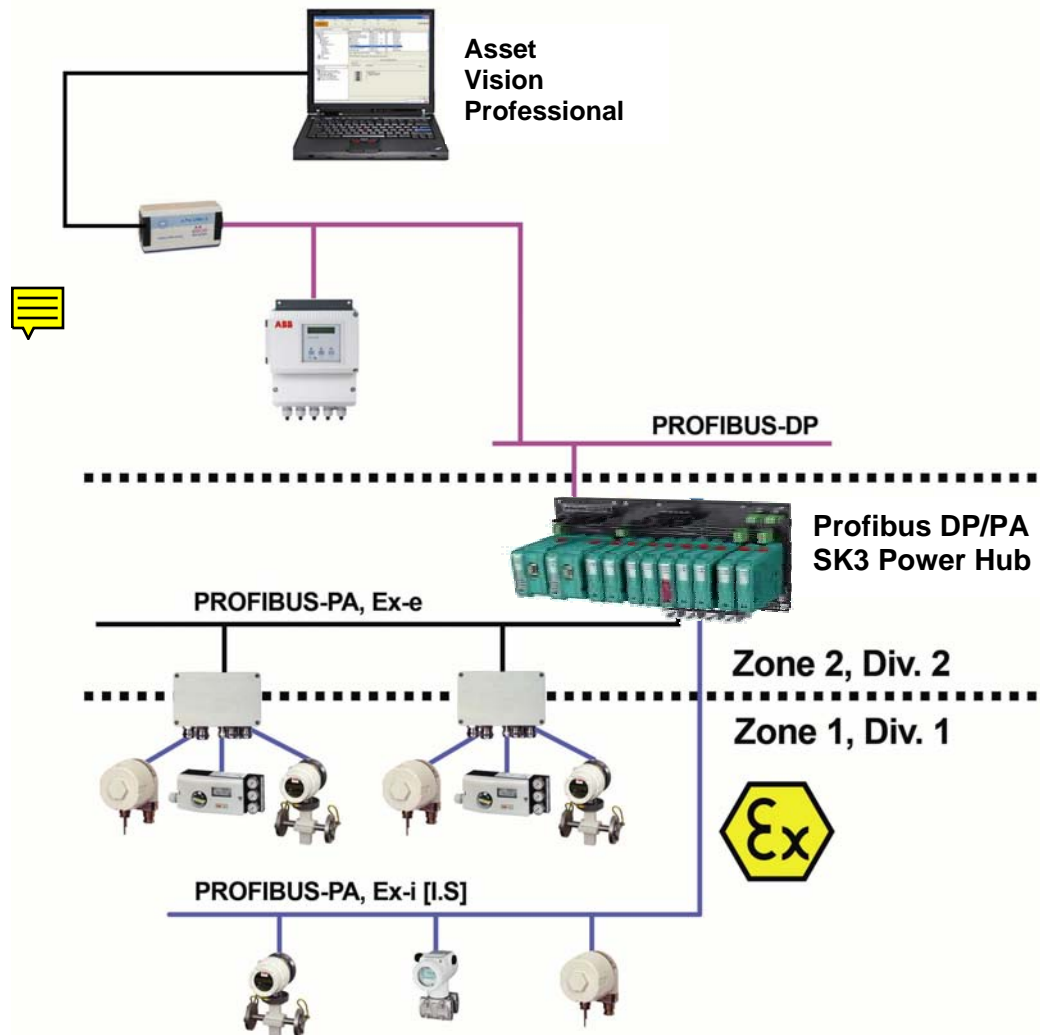

Figure 17. Example of fieldbus structure with SK3 Power Hub



PROFIBUS DP Interface Adapter: A PROFIBUS network is set up with the PROFIBUS DP interface adapter. The adapter supports DPV1 services. This is necessary for field device communication via FDT/DTM technology.

PROFIBUS DP/PA SK3 Power Hub: The SK3 PROFIBUS DP/PA Power Hub is an efficient solution for connecting PROFIBUS PA devices to a DP modem or process control system connection. The modular SK3 consists of a Gateway module to convert the PROFIBUS DP protocol to PROFIBUS PA, and Power Supply Modules for supplying the connected PROFIBUS PA devices with power. As an option, the power supply modules can connect to devices in hazardous areas (Zone 1, Div. 1/Class 1).

The power hub can be fully transparent in the network. As a result, it is not necessary to address, configure, or parameterize the Linking Device.

Design and configuration of the field devices is accomplished with the PROFIBUS fieldbus management tool in a similar method used for HART devices. It enables the integration of field devices by using FDT/DTM technology. Note, the FDT/DTM technology is described in the previous Plug and Produce section.

The PROFIBUS fieldbus management tool allows for adding, moving, removing, or copying PROFIBUS DP and PA devices. It enables calling up and using DTMs in Asset Vision Professional. Upload, download and commissioning for PROFIBUS devices are easily handled by the tool. Network information, such as cycle time and live list are available for diagnostics.

The fieldbus management tools enable the integration, configuration and diagnostics of PROFIBUS devices supporting the PROFIBUS DP and PROFIBUS PA protocol. The configuration can be performed offline without the connected field device as well as online using the specific DTM. During commissioning, the configured parameter set of each field device is downloaded with a single mouse click.

Field Device Library: The PROFIBUS Field Device Library contains ABB and third party field device objects enhanced with the essential aspects for

- Configuration
- Parameterization
- Commissioning/diagnostics
- Maintenance management (CMMS connectivity)
- Device documentation

Notes

---

ABB has Sales & Customer Support  
Expertise in over 100 countries worldwide  
[www.abb.com](http://www.abb.com)

The Company's policy is one of continuous product  
Improvement and the right is reserved to modify the  
Information contained herein without notice.

Printed in US (12/2008)

© ABB 2008



**ABB Inc.**  
125 East County Line Road  
Warminster, PA 18974  
USA  
Tel: +1 215 674 6000  
Fax: +1 215 674 7183

**ABB Limited**  
Howard Road, St. neots  
Cambridgeshire, PE19 8EU  
UK  
Tel: +44 (0) 1480 475321  
Fax: +44 (0) 1480 217948

3KXD51801R3001\_A (TI-DAT-801-Overview\_A)