



The Company

We are an established world force in the design and manufacture of instrumentation for industrial process control, flow measurement, gas and liquid analysis and environmental applications.

As a part of ABB, a world leader in process automation technology, we offer customers application expertise, service and support worldwide.

We are committed to teamwork, high quality manufacturing, advanced technology and unrivalled service and support.

The quality, accuracy and performance of the Company's products result from over 100 years experience, combined with a continuous program of innovative design and development to incorporate the latest technology.

The UKAS Calibration Laboratory No. 0255 is just one of the ten flow calibration plants operated by the Company, and is indicative of our dedication to quality and accuracy.

EN ISO 9001:2000



Cert. No. Q5907

EN 29001 (ISO 9001)



Lenno, Italy – Cert. No. 9/90A

Electrical Safety

This equipment complies with the requirements of CEI/IEC 61010-1:2001-2 "Safety requirements for electrical equipment for measurement, control, and laboratory use". If the equipment is used in a manner NOT specified by the Company, the protection provided by the equipment may be impaired.

Symbols

One or more of the following symbols may appear on the equipment labelling:

	Warning – Refer to the manual for instructions
	Caution – Risk of electric shock
	Protective earth (ground) terminal
	Earth (ground) terminal

	Direct current supply only
	Alternating current supply only
	Both direct and alternating current supply
	The equipment is protected through double insulation

Information in this manual is intended only to assist our customers in the efficient operation of our equipment. Use of this manual for any other purpose is specifically prohibited and its contents are not to be reproduced in full or part without prior approval of the Technical Communications Department.

Health and Safety

To ensure that our products are safe and without risk to health, the following points must be noted:

1. The relevant sections of these instructions must be read carefully before proceeding.
2. Warning labels on containers and packages must be observed.
3. Installation, operation, maintenance and servicing must only be carried out by suitably trained personnel and in accordance with the information given.
4. Normal safety precautions must be taken to avoid the possibility of an accident occurring when operating in conditions of high pressure and/or temperature.
5. Chemicals must be stored away from heat, protected from temperature extremes and powders kept dry. Normal safe handling procedures must be used.
6. When disposing of chemicals ensure that no two chemicals are mixed.

Safety advice concerning the use of the equipment described in this manual or any relevant hazard data sheets (where applicable) may be obtained from the Company address on the back cover, together with servicing and spares information.

CONTENTS

Section	Page
1 INTRODUCTION	2
2 GENERAL PROGRAMMING	2
2.1 Preparation for Changes to the Parameters	2
3 SELECTING THE CONTROL TYPE ..	3
4 CONFIGURATION	4
4.1 Profile Program Page	4
4.2 Set Points Page	6
4.3 Motorized Valve Control	11
4.3.1 Position Feedback Page	12
4.4 Motorized Valve Control without Feedback (Boundless)..	13
4.4.1 Calculation for Control Pulses Steps and Deviation (Boundless Control only)	13
4.4.2 Regulator Data Page	14
4.5 Set Up Process Variable	15
4.5.1 Set Up Process Variable Input Page (COMMANDER 300)	16
4.6 Set Up Remote Set Point Page.	20
4.7 Set Up Position Feedback Page	22
4.8 Set Up Display Page	24
4.9 Current Proportioning Output Page	25
4.10 Set Up Control Page	28
4.11 Set Up Alarms Page	37
4.12 Retransmission Output Page	44
4.13 Cool Output Page	44
4.14 Scale Adjustment Page	45
4.15 Access Page	48
4.16 Set Up Process Variable Input Page (COMMANDER 301 only)	49

1 INTRODUCTION



The COMMANDER 300 Series of documentation is shown in Fig. 1.1. The **Standard Manuals**, including the specification sheet, are supplied with all instruments. The **Modbus Supplement** is supplied with instruments configured for Modbus Serial Communication.

The Installation manual includes an **Installation Record** which should be completed as a log of the electrical installation. The record is useful when carrying out initial instrument programming and can be retained for future reference

2 GENERAL PROGRAMMING

2.1 Preparation for Changes to the Parameters

Ensure that the external alarm/control circuits are isolated if inadvertent operation during programming is undesirable.

Any change to the operating parameters are implemented using the  or  switches – see *Section 3 of the Operating Guide*.

Note. The instrument responds instantly to parameter changes which are saved when the  switch is pressed.

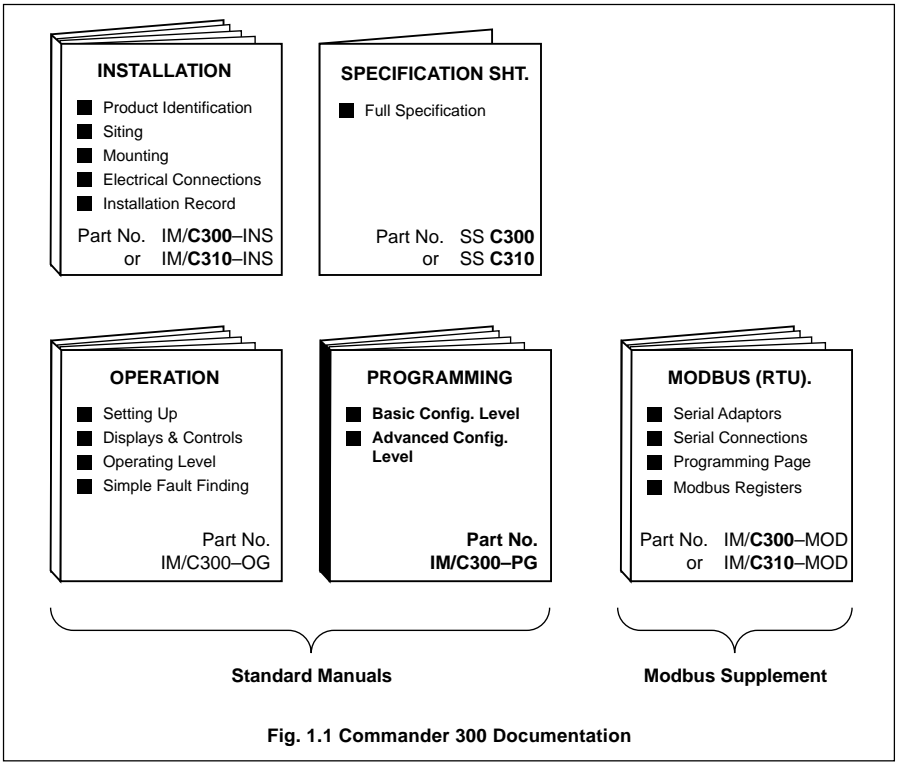

Fig. 1.1 Commander 300 Documentation

3 SELECTING THE CONTROL TYPE

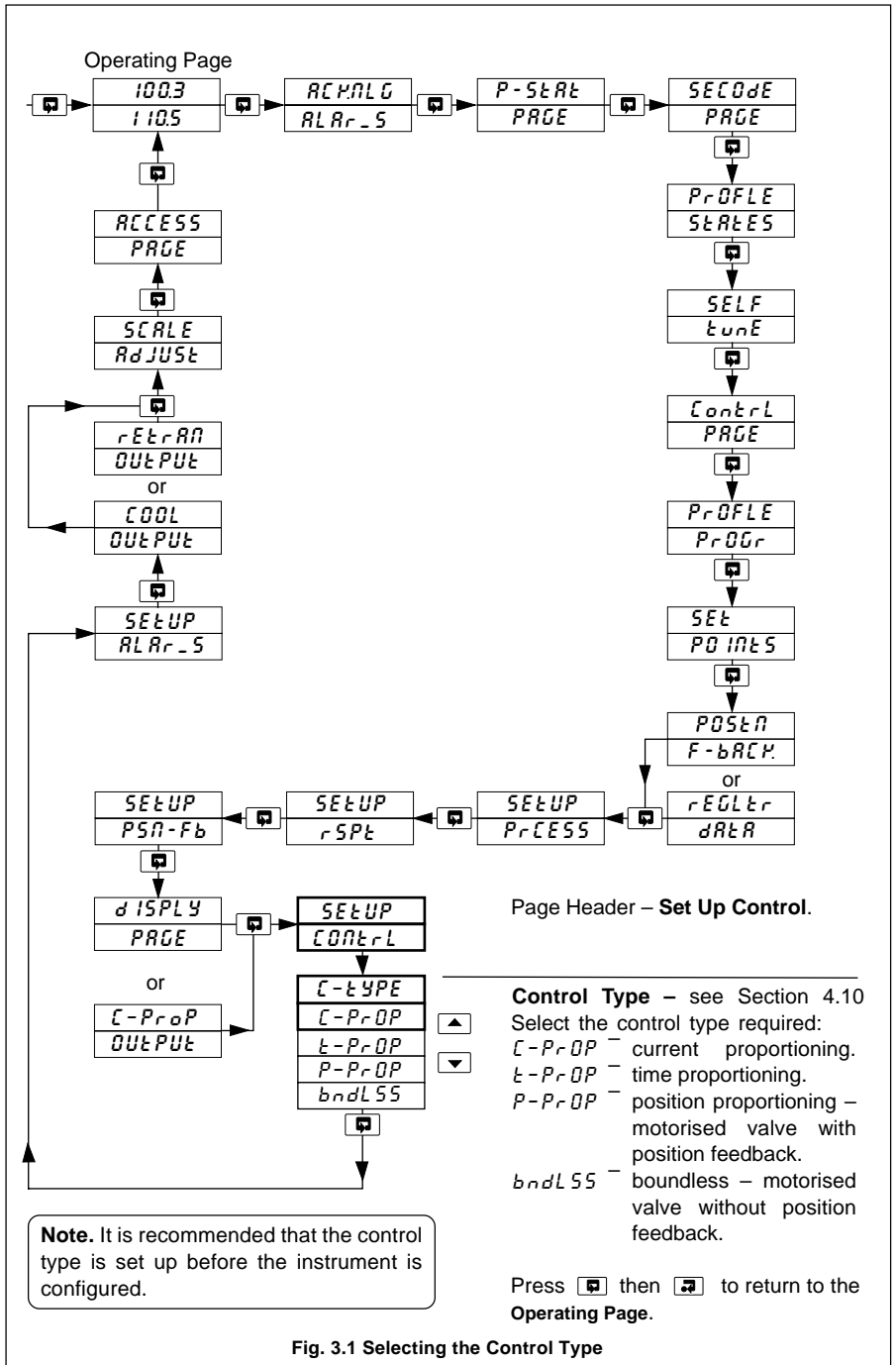

Fig. 3.1 Selecting the Control Type

4 CONFIGURATION

4.1 Profile Program Page

Information.

- This page is inaccessible when a profile is running.
- Up to 9 programs for the C300/C310 (3 for the C301, 20 for the C302).
- Total of 30 segments for the C300/C310 (12 for the C301, 99 for the C302).
- Guaranteed Ramp/Soak feature.
- Repeat facility for each program.

Page Header – Profile Program.

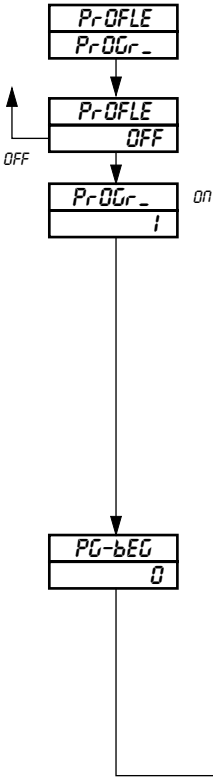
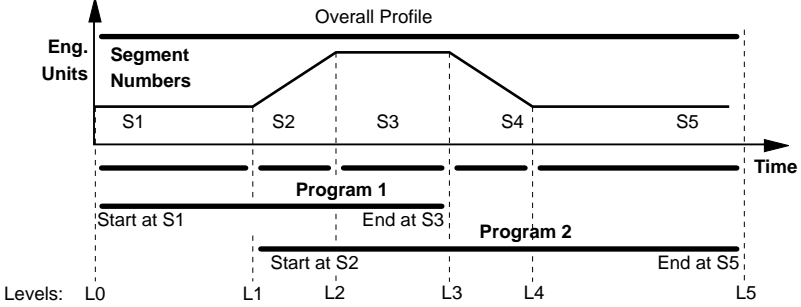

Profile Enable

Select the profile function, *on* or *OFF*.

Program Select

Select the program required, between 1 and 9 (3 for C301, 20 for C302).

A program consists of up to 30 (12 for C301, 99 for C302) segments. Each segment has a starting and finishing set point level, giving a maximum of 31 (13 for C301, 100 for C302) levels. For identification purposes these levels are numbered 0 to 30 (12 for C301, 99 for C302), e.g.:

Level 1 is the finishing level of segment 1 and the starting level of segment 2

Level 10 is the finishing level of segment 10 and the starting level of segment 11.

Program Begin (start level)

This is the first level number of the program selected at **Program Select** above.

Set the program start level number for the program chosen at **Program Select**, between 0 and 29 (11 for C301, 98 for C302).

Continued on next page.

...4.1 Profile Program Page

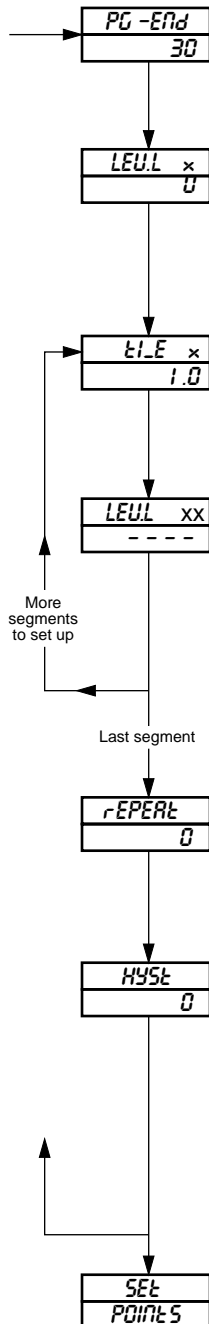
**Program End (finish level)**

Set the program end level number for the program chosen at **Program Select**, between 1 and 30 (12 for C301, 99 for C302).

Program First Segment Start Level

The number shown in the upper display is the start level number for the first segment.

Set the required value for the start level.

The units are display units between **Display Zero** and **Display Full Scale**.

Segment Time Period

The time number of the currently selected segment is shown in the upper display.

Set the required time period, between 0 and 999.9 minutes in 0.1 minute increments.

Segment Finish/Start Level

The number shown in the upper display is the finish level number for the currently selected segment and the start number for the next segment.

Set the required value for the segment finish/start level. The units are display units between display zero and full scale.

Advance to the next parameter, **Segment Time Period**, if more segments are to be set-up or **Repeat** if the current segment is the last segment.

Program Repeat

Each program can be set to repeat up to 99 times or continuously.

Set the required repeat count, between 0 and 99, or *INFINITE* for continuous repeats.

Program Hysteresis Value (for guaranteed ramp/soak)

A hysteresis value can be set in engineering units. Setting the value to zero turns the guaranteed ramp/soak facility off. If the process variable deviates beyond the value set, the program is suspended but continues automatically when the process variable returns within the set limits. The hysteresis value applies above and below set point under all program conditions.

Set the hysteresis value required, within the display range limits.

Return to top of **Profile Program Page**

or

advance to **Set Points Page**.

4.2 Set Points Page

Information.

- Two local set points – Local and Dual.
- Remote set point facility – with Ratio and Bias.
- Remote set point tracking options – for bumpless Remote-to-Local set point transfers.
- Adjustable high and low limits for all set point types.
- Set point tracking for bumpless Manual-to-Auto transfers.

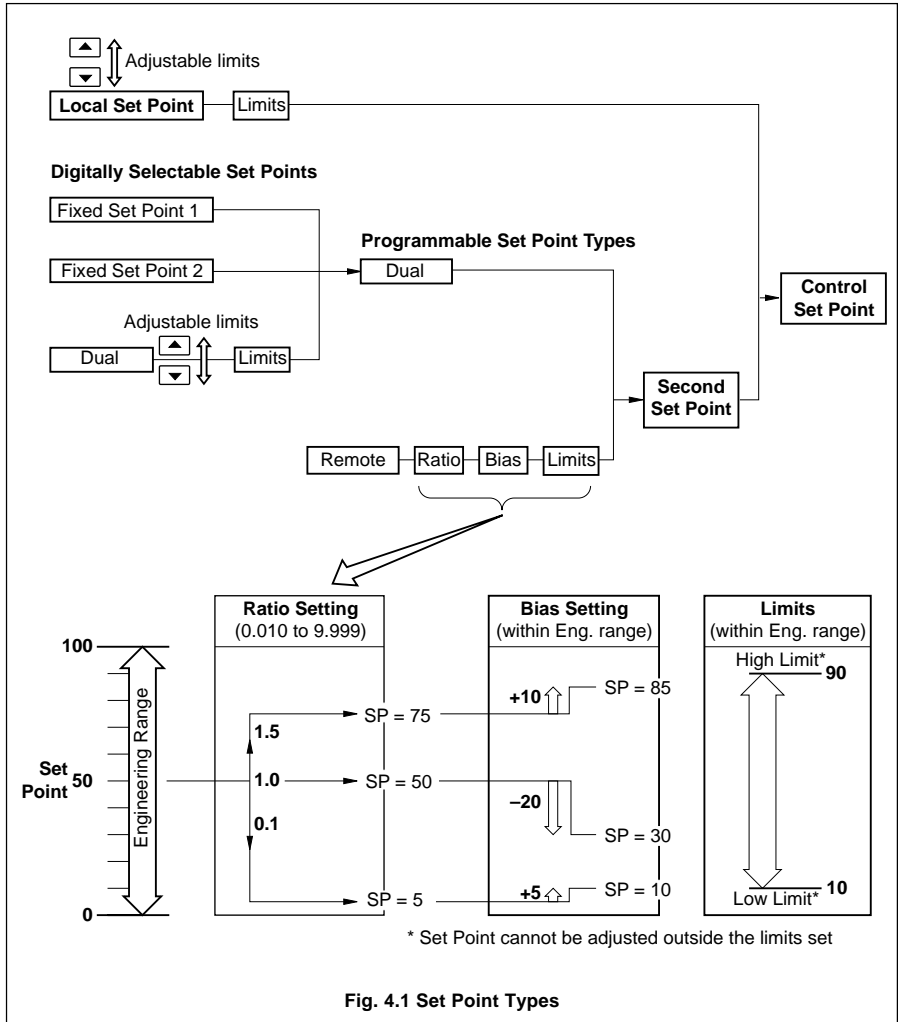
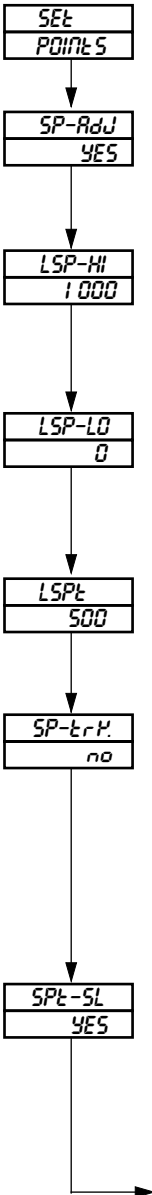

Fig. 4.1 Set Point Types

...4.2 Set Points Page

To gain access to this and subsequent pages the correct Configuration code must first be set in the Security Code Page – see *Section 5.5 of the Operating Guide*.



Page Header – **Set Points.**

Set Point Adjustment Enable

This frame allows display and adjustment of the set point in the **Operating Page Displays** (see *Section 5.2 of the Operating Guide*). Select **YES** to enable or **no** to disable.

Set Point High Limit

This is the maximum value to which the local set point can be adjusted.
Set the value required. The decimal point position is set automatically.

Set Point Low Limit

This is the minimum value to which the local set point can be adjusted.
Set the value required. The decimal point position is set automatically.

Local Set Point Value

Set the value required, within the limits set above. The decimal point position is set automatically to that set in the **Set Up Display Page** – see Section 4.8.

Set Point Tracking Enable

If **Set Point Tracking** is enabled and the controller is in Manual mode the local set point tracks the process variable. When the controller is in **Set Point Tracking** mode the local set point limits can be exceeded. If the local set point is outside of its limits when the tracking mode is disabled, the local set point value can only be adjusted towards its limits. Once within the limits they apply as normal.
Select **YES** to enable or **no** to disable.

Set Point Select

This frame enables selection of set point type from the **Operating Page** i.e., **LOCAL**, **REMOTE**, or **DUAL** as applicable – see **Set Point Type Selection** (*Section 5.2 of the Operating Guide*).
Select **YES** to enable, or **no** to disable.

Continued on next page.

...4.2 Set Points Page

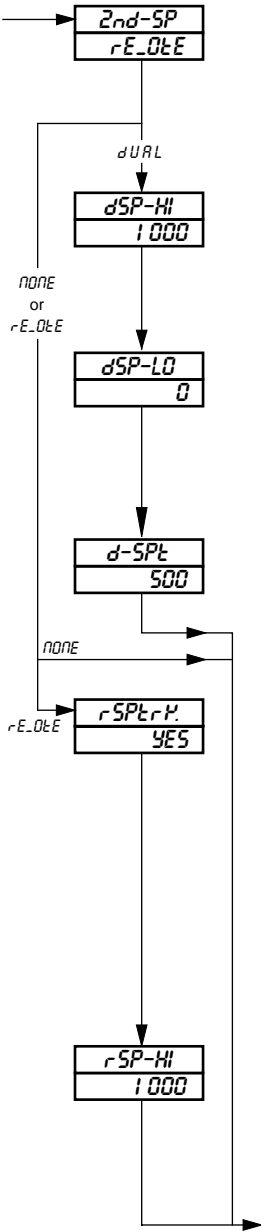

Second Set Point Type

This frame enables the setting up of a Second set point in addition to the Local set point.

Select the second set point type, *NONE* (no Second set point), *dUAL* (Dual set point) or *rE.OtE* (Remote set point).

Dual Set Point High Limit

This is the maximum value to which the Dual set point can be adjusted.

Select the value required. The decimal point position is set automatically.

Dual Set Point Low Limit

This is the minimum value to which the Dual set point can be adjusted.

Select the value required. The decimal point position is set automatically.

Adjustable Dual Set Point Value

Set the value required, restricted to the limits set in **Dual Set Point High Limit** and **Dual Set Point Low Limit** above.

Advance to **Set Point Type Selection** on page 10.

Remote Set Point Tracking Enable

If **Remote Set Point Tracking** is enabled and the controller is in Remote mode the Local set point tracks the remote set point. When the controller is in **Remote Set Point Tracking** mode the local set point limits can be exceeded. If the local set point is outside of its limits when the tracking mode is disabled, the Local set point value can only be adjusted towards its limits. Once within the limits they apply as normal. With Remote set point tracking enabled; if the controller is put into Manual mode, the set point reverts from remote to Local. Select *YES* to enable or *no* to disable.

Remote Set Point High Limit

This is the maximum value to which the Remote set point can be adjusted.

Select the value required. The decimal point position is set automatically.

Continued on next page.

...4.2 Set Points Page

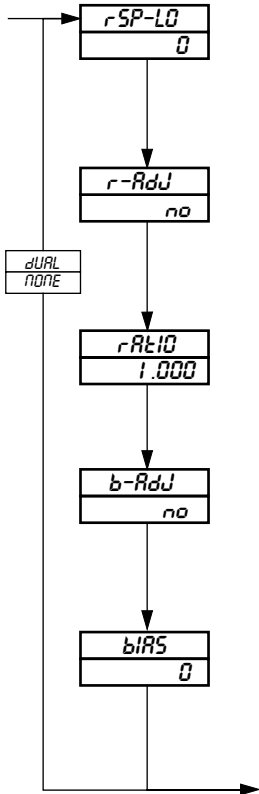
**Remote Set Point Low Limit**

This is the minimum value to which the remote set point can be adjusted.

Select the value required. The decimal point position is set automatically.

Remote Set Point Ratio Adjust Enable

This frame enables or disables the display and adjustment of the remote set point ratio in the Operating Page (see *Section 5.2 of the Operating Guide*).

Select *YES* to enable or *no* to disable.

Remote Set Point Ratio

This is a scaling factor, i.e. multiplies the remote set point input by the ratio value set. Set the required remote set point ratio, between 0.010 and 9.999 in 0.001 increments.

Remote Set Point Bias Adjust Enable

This frame enables or disables the display and adjustment of the remote set point bias in the Operating Page (see *Section 5.2 of the Operating Guide*).

Select *YES* to enable or *no* to disable.

Remote Set Point Bias

This is an offset value set as a proportion of display span (may be \pm the span value).

Set the remote set point bias in engineering units.

Continued on next Page.

...4.2 Set Points Page

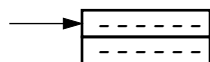

Set Point Type Selection

This frame displays the current set point type, or *bALANCE* and value – see **Set Point Type Selection** frame in the **Operating Page** – see *Section 5.2 of the Operating Guide*.

Upper Display – displays the set point type, or *bALANCE*:

- LOCAL* – Local set point
- bALANCE* – Balance, the difference between the Local and Remote (or Dual) set point values
- rE_0tE* – Remote set point on controllers with Remote set point facility
- dUAL* – Dual set point

Lower Display – displays the value of the set point type shown in the upper display, but if the set point type is changed from Local to Remote (or Dual) the display shows the difference (*bALANCE*) between the Local set point value and the Remote (or Dual) set point value.

When Remote set point is selected and if Remote set point tracking is enabled the Local set point value tracks the Remote set point value. The Local set point limits do not apply in this mode. If the Local set point is outside of its limits when Local set point type is re-selected, it can only be adjusted towards its limits. Once within these limits, they apply as normal.

Press  to select *LOCAL*, *bALANCE*, *rE_0tE* (or *dUAL*). *rE_0tE* and *dUAL* are dependent on the selection made at **Second Set Point Type** parameter.

Return to the top of **Set Points Page** or advance to the next page.

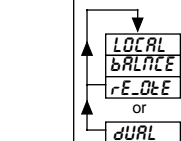

4.3 Motorized Valve Control

Information.

- Motorized valve control with or without feedback – position-proportioning (with feedback) or boundless (without feedback).
- Ratio and bias settings can be applied to adjust the range of valve travel (position-proportioning only).
- Deadband setting – adjustable to minimize hunting of the motorized valve.

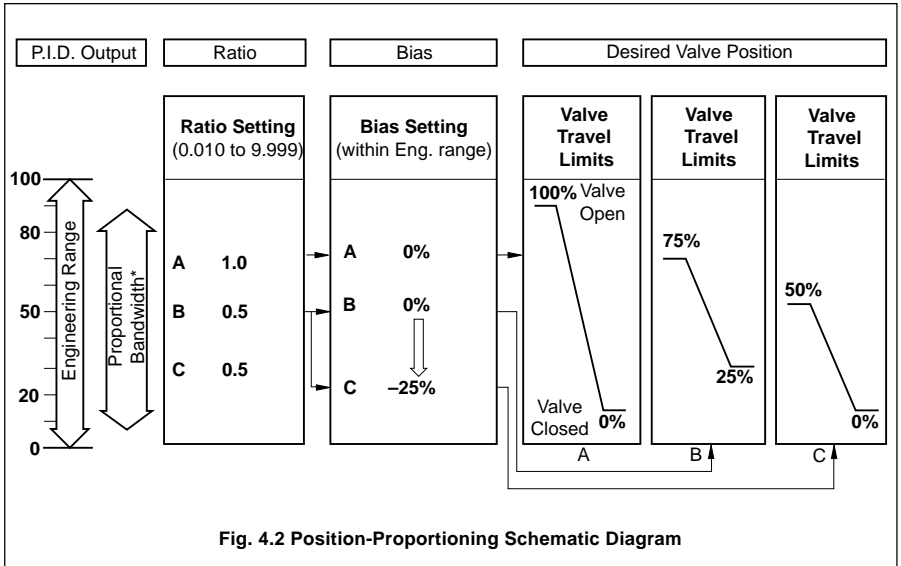

4.3.1 Position Feedback Page

This page appears only if P-PrOP is selected at the **Control Type** parameter in the **Set Up Control Page** – see Fig. 3.1 and Section 4.10.

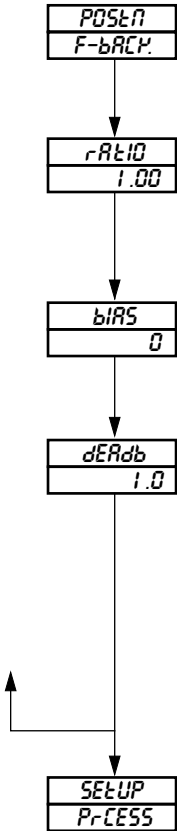

Page Header – Position Feedback Page

Ratio

Ratio is a scaling factor, i.e. multiplies the position feedback input by the value set here.
Set the required feedback ratio, between 0.0 and 9.99 in 0.01 increments.

Bias

Bias is an offset as a percentage of the valve travel.
Set the required feedback bias, between -100.0 and +100.0%.

Deadband

Deadband is set as a percentage of the position feedback span, between 0.0 and 10.0%, to produce a deadband around the valve control value. This gives minimum 'hunting' of the motorized valve.

Example – if the valve is to be driven to the 50% open position and the deadband is set to 4.0%, the motor stops driving when the position feedback is 48%. In this example the deadband is between 48% and 52%.

Return to the top of the **Position Feedback Page** or advance to next page.

4.4 Motorized Valve Control without Feedback (Boundless) – Fig. 4.3

A 'boundless' process controller provides an output that is effectively the time derivative of the required regulator position, i.e. the controller signals the regulator, not where to go to (position derivative), but in which direction to travel and how far to move, by a series of integral action pulses. Thus, the controller does not need to know the absolute regulator position and is unaffected when regulator reaches the upper or lower limit, as determined by the regulator's limit switches (giving rise to the term 'boundless').

In this system, the final regulator must act as an integrator, integrating both the raise and lower pulses in direction and duration so that the final position of the regulator reproduces the required 2 or 3 term control function, and must remain stationary indefinitely in the absence of raise or lower commands.

When a deviation from set point is introduced the regulator is driven, for a length of time equivalent to the proportional step. The regulator is then driven by integral action pulses until the deviation is within the deadband setting.

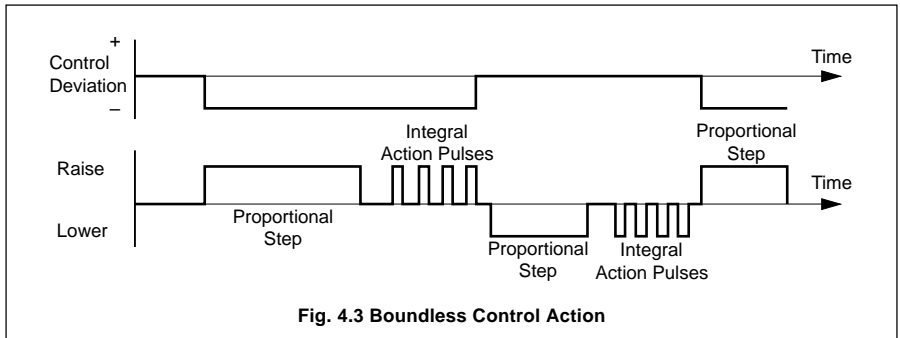

4.4.1 Calculation for Control Pulses, Steps and Deviation (Boundless Control only)

Minimum 'ON' time of integral action pulses (for a fixed control deviation).

$$= \frac{\text{Travel Time} \times \text{Deadband \%}}{\% \text{ Proportional Band}} \quad (\text{in seconds})$$

Minimum (approximate) time between integral action pulses (for a fixed control deviation)

$$= \frac{\text{Integral Action Time} \times \text{Deadband \%}}{2 \times \% \text{ Control Deviation}} \quad (\text{in seconds})$$

Duration of the proportional step

$$= 2 \times \left[\frac{\% \text{ Control Deviation}}{\% \text{ Proportional Band}} \right] \times \text{Travel Time in Seconds}$$

$$\% \text{ Control Deviation} = \frac{\text{Set Point} - \text{Process Variable}}{\text{Span}}$$

4.4.2 Regulator Data Page

This page is displayed only when *bndLESS* is selected at **Control Type** frame in the **Set Up Control Page** – see Fig. 3.1 and Section 4.10.

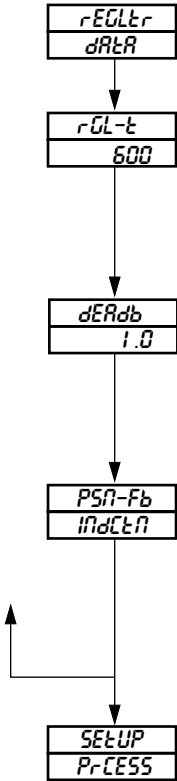

Page Header – Regulator Data

Regulator Travel Time

This is the time set for the regulator to travel from the fully open to the fully closed position or from the fully closed to the fully open position.

Set the value required in seconds, between 1 and 5000 seconds.

Deadband Setting

The deadband is set as a percentage of the engineering range span to produce a deadband around the control set point value. This reduces 'hunting' of the regulator.

Set the required value, between 0.0 and 10.0%.

Position Feedback Indication Enable

Select *INdCtN* to enable the **Valve Position** frame in the **Operating Page** – see *Section 5.2 of the Operating Guide*. Select *NOtE* to disable the **Valve Position** frame.

Note. A value is only displayed in the **Valve Position** frame if the frame is enabled and the regulator has a feedback signal.

Return to top of **Regulator Data Page**,

or

Advance to **Set-up Process Variable Input Page**.

4.5 Set Up Process Variable

Information.

- Universal inputs – mV, mA, V, THC, RTD and resistance.
- Internal cold junction compensation.
- Linearization of temperature sensors to allow use of non-linearizing transmitters or any electrical input.
- Programmable fault levels and actions.
- Digital filter reduces the effect of noise on inputs.

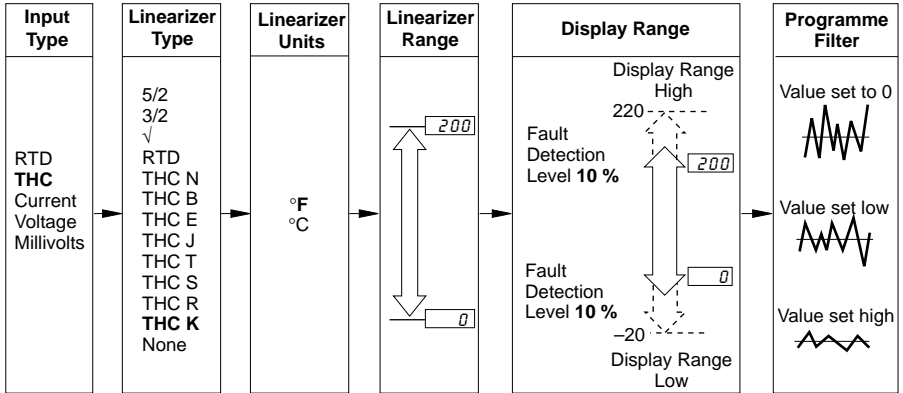

Example – Type K thermocouple Range 0 to 200°F with 10% fault detection levels.

4.5.1 Set Up Process Variable Input Page (COMMANDER 300)

If the custom linearizer is to be used (available on COMMANDER 301 only), refer to Section 4.16.



Page Header – Set Up Process Variable Input.

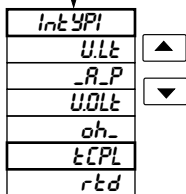

Process Variable Input Type

Select the input type required:

- _ULt* – Millivolt (≤ 2000 mV)
- _R_P* – Current
- UDLt* – Voltage
- oh_* – Resistance
- tCPL* – Thermocouple *
- rtd* – Resistance thermometer

*For thermocouple applications using an external fixed cold junction, select millivolt input type.

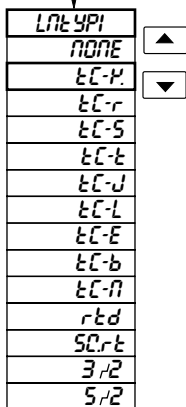

Linearizer Type

Select the linearizer type required:

- NONE* – No linearizer
- tC-P* – Type K thermocouple
- tC-r* – Type R thermocouple
- tC-S* – Type S thermocouple
- tC-t* – Type T thermocouple
- tC-J* – Type J thermocouple
- tC-L* – Type L thermocouple
- tC-E* – Type E thermocouple
- tC-b* – Type B thermocouple
- tC-N* – Type N thermocouple
- rtd* – Resistance thermometer
- SCrt* – Square root
- 3/2* – $x^{3/2}$
- 5/2* – $x^{5/2}$

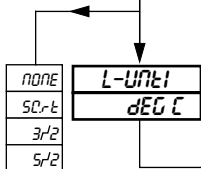

Linearizer Units

Select the temperature units required, °C or °F.

- (a) Continued on next page.
- (b) Continued on page 18.

...4.5.1 Set Up Process Variable Input Page

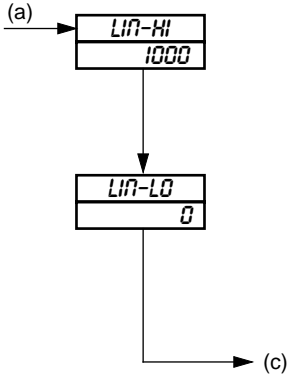
**Linearizer Full Scale**

Set the range maximum temperature in °C or °F as selected at **Linearizer Units** above, within the limits detailed in Table 4.1. If these limits are exceeded, *LIN-OR* (linearizer overrange) is displayed in the **Operating Page** – see Table 5.1a of the *Operating Guide*.

Linearizer Zero

Set the range minimum temperature in °C or °F as selected at **Linearizer Units** above, within the limits detailed in Table 4.1.

(c) Continued on next page. (for b and c)

THC / RTD Type	Degrees Celsius			Degrees Fahrenheit		
	Min.	Max.	Min. Span	Min.	Max.	Min. Span
Type B*	- 18	1800	710	0	3272	1278
Type E	- 100	900	45	- 148	1652	81
Type J	- 100	900	50	- 148	1652	90
Type K	- 100	1300	65	- 148	2372	117
Type L	- 100	900	50	- 148	1652	90
Type N	- 200	1300	90	- 328	2372	162
Type R & S*	- 18	1700	320	0	3092	576
Type T	- 250	300	60	- 418	572	108
RTD	- 200	600	25	- 328	1112	45

* Accuracy for type B,R and S is not guaranteed below 400°C.

Minimum span below zero Type T 70°C/126°F

THC standard DIN 43710 IEC 584

RTD standard DIN 43760 IEC 751

Table 4.1 Temperature Limits

...4.5.1 Set Up Process Variable Input Page

(b) from page 16

→

<i>r-HI-I</i>
1000

↓

<i>dEC-Pl</i>
1000

↓

<i>r-LO-I</i>
0

(c) from page 17

↓

<i>bSPd</i>	▲
<i>none</i>	
<i>UP</i>	▼
<i>dN</i>	

Input Range Full Scale

Set the input range maximum in electrical units, **within the limits detailed in Table 4.2.**

Example – to set an input range full scale of 20mA, enter 200 in the input full scale display and advance to decimal point display. Set the decimal point one place to give a value of 20.0.

Decimal Point

Set the decimal point position required for both the range full scale and range zero values.

Input Range Zero

Set the input range minimum in electrical units, **within the limits detailed in Table 4.2.**

Broken Sensor Protection Drive

In the event of a fault being detected on the input, the process variable is driven in the direction of the mode selected.

Select the broken sensor drive required:

- none* – No drive
- UP* – Upscale drive
- dN* – Downscale drive.

Continued on the next page.

Input Type	Min. Start	Max. Value	Min. Span
Millivolts	- 2000	2000	2.5
Volts	- 20	20	0.25
Milliamps	- 100	100	0.25
Resistance	0	8000	10

Table 4.2 Electrical Limits

...4.5.1 Set Up Process Variable Input Page

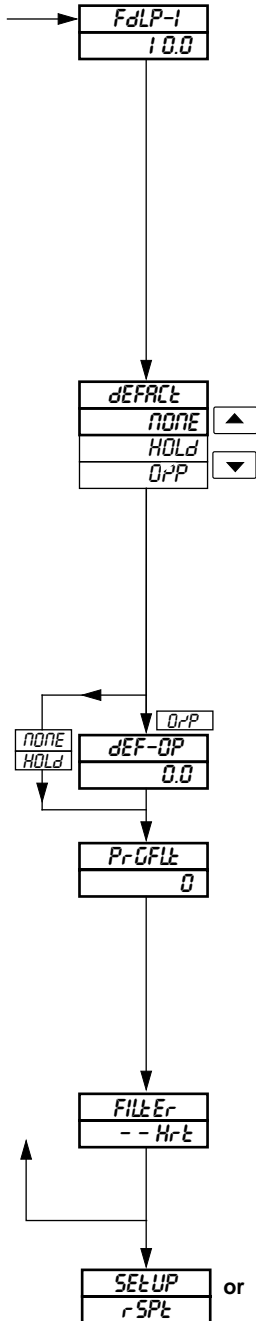

Fault Detection Level Percentage, Process Variable Input

A fault level percentage can be set to detect a deviation above or below the display limits, e.g. If set at 10.0%, then if an input goes more than 10% above full scale value or more than 10% below zero value, a fault is detected.

On some ranges the input circuitry may saturate before the fault level set is reached. In this case an error is detected at a level below that which is set.

Control actions and control outputs in the event of a fault are programmable – see below.

Set the value required, between 0.0 and 100.0% in 0.1% increments.

Default Control Action

Select the default control action required in the event of a fault:

- none* – No default action.
- HOLD* – The controller reverts to Manual mode when an error is detected. The control output is held at the value existing when the error was detected.
- OPP* – The controller reverts to Manual mode when an error is detected and the control output value changes to the **Default Control Output** value following.

Default Control Output

Set the default output value required in the event of a fault, between 0.0 and 100.0%.

Programmable Filter

This filters the process variable input, i.e. if the input is stepped, it smooths the transition between steps and may also be used for some degree of cleaning of noisy inputs. The filter time represents the time a step in the input takes to change the displayed process variable from 10 to 90% of the step.

Set value required, between 0 and 60 in 1 second increments.

Mains Filter

Set the frequency of the mains supply used (50 or 60Hz).

Return to top of **Process Variable Input Page** or advance to next program page.

4.6 Set Up Remote Set Point Page

Information.

- This page is omitted if Remote set point is not selected at Second Set Point Type in Set Points Page – see Section 4.2.
- Universal Input.

Page Header – **Set Up Remote Set Point Input.**

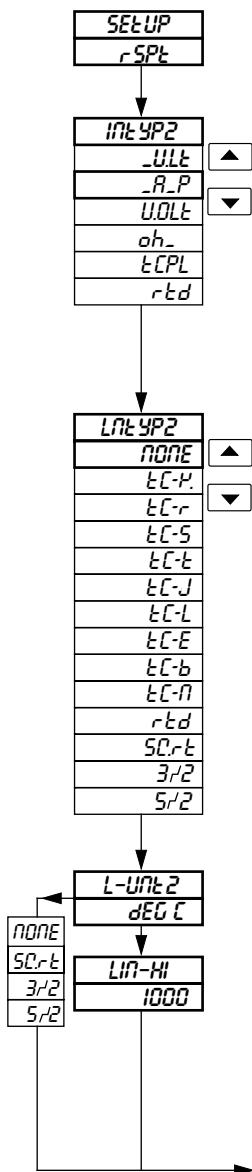

Remote Set Point Input Type

Select the input type required:

_ULt	-	Millivolt ($\leq 2000\text{mV}$)
_R_P	-	Current
UDLt	-	Voltage
oh_	-	Resistance
tCPL	-	Thermocouple*
rtd	-	Resistance thermometer

*For thermocouple applications using an external fixed cold junction, select millivolt input type.

Remote Set Point Linearizer Type

Select the linearizer type required:

NONE	-	No linearizer
tC-P	-	Type K thermocouple
tC-r	-	Type R thermocouple
tC-S	-	Type S thermocouple
tC-t	-	Type T thermocouple
tC-J	-	Type J thermocouple
tC-L	-	Type L thermocouple
tC-E	-	Type E thermocouple
tC-b	-	Type B thermocouple
tC-n	-	Type N thermocouple
rtd	-	Resistance thermometer
SCrt	-	Square root
3/2	-	$x^{3/2}$
5/2	-	$x^{5/2}$

Linearizer Units

Select the temperature units required, °C or °F.

Linearizer Full Scale

Set the range maximum temperature in °C or °F as selected at **Linearizer Units** above, within the limits detailed in Table 4.1. If limits are exceeded, *L In-Dr* (linearizer overrange) is displayed in the **Operating Page** – see Table 5.1a of the *Operating Guide*.

Continue on next page.

...4.6 Set Up Remote Set Point Input Page

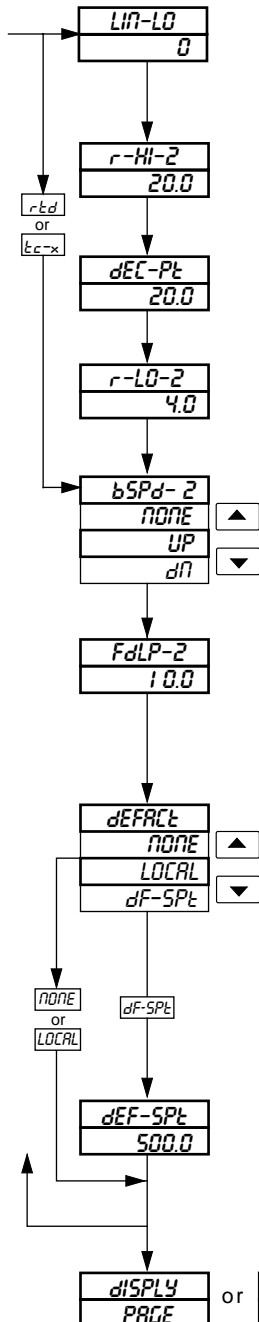
**Linearizer Zero**

Set the range minimum temperature in °C or °F as selected at **Linearizer Units** above, within the limits detailed in Table 4.1.

Remote Set Point Range Full Scale

Set the remote set point range full scale value within the limits in Table 4.2 – see page 18.

Decimal Point

Set the decimal point position required for **both** the range full scale and range zero values.

Input Range Zero

Set the remote set point range zero value required within the limits in Table 4.2 – see page 18.

Broken Sensor Protection Drive

In the event of a fault being detected on the input, the remote set point is driven according to the Broken Sensor Protection Drive. Select the drive required: **NONE** for no drive, **UP** for upscale drive or **dN** for downscale drive.

Fault Detection Level Percentage, Remote Set Point

This frame is as detailed in the **Fault Detection Level Percentage, Process Variable Input frame** – see page 19. Set the value required, between 0.0 and 100.0% in 0.1% increments.

Default Action (Remote Set Point)

Select the default action required in the event of an error:

- NONE** – No default action.
- LOCAL** – The controller reverts to local mode when an error is detected and the local set point value is used.
- dF-SPt** – The controller reverts to local mode when an error is detected and the set point value changes to the **Default Set Point** value below.

Default Set Point

Set the default set point value required in the event of an error.

Return to top of **Remote Set Point Input Page** or advance to the next programming page.

4.7 Set Up Position Feedback Page

Information.

- This page is only present if *P-PrOP* or *bndL55* is selected at Control Type in the Set Up Control Page – see Fig. 3.1 and Section 4.10. If *bndL55* is selected, Position Feedback Enable must be set to *INDLEN* to enable access to this page.
- Millivolt, current, voltage or resistance input.
- Programmable fault level and actions.

SETUP
PSN-Fb

Page Header – Set Up Position Feedback.

INLYP3
_ULt ▲
_R_P ▼
UOLt
oh_

Position Feedback Input Type

Select the input type required:

_ULt	-	Millivolt ≤2000mV
_R_P	-	Current
UOLt	-	Voltage
oh_	-	Resistance

r-HI-3
135.0

Position Feedback Range Full Scale

Set the position feedback range full scale value, within the limits of Table 4.2 – see page 18.

dEC-Pl
135.0

Decimal Point Position

Set the decimal point position required for both the position feedback range full scale and range zero values.

r-LO-3
0.0

Position Feedback Range Zero

Set the position feedback range zero value, within the limits of Table 4.2 – see page 18.

bSPd-3
NONE ▲
UP ▼
dN

Broken Sensor Protection Drive

In the event of a fault being detected on the input, the remote set point is driven in the direction of the mode selected.

Select the broken sensor drive required: *NONE* for no drive, *UP* for upscale drive or *dN* for downscale drive.

FdLP-3
1.00

Fault Detection Level Percentage, Position Feedback Input

A fault level percentage can be set to detect a deviation above or below the display limits, e.g. If set to 10.0%, then if the position feedback input deviates by more than 10% above Full Scale value or 10% below zero value, a fault is detected. Position feedback action in the event of a fault is programmable, see **Default Action**.

Set the value required, between 0.0 and 100.0%.

Continued on next page.

...4.7 Set Up Position Feedback Page

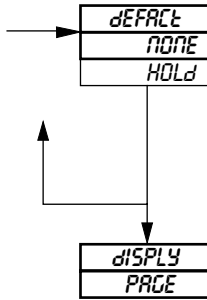
**Default Action**

Select the default position feedback action required:

NONE – No default action

HOLD – The controller reverts to Manual mode and holds the valve position existing when the fault was detected.

Return to top of **Set Up Position Feedback Input Page**.

or

Advance to **Set Up Display Page**.

4.8 Set Up Display Page

Information.

- Set up engineering ranges and units.
- Programmable increments on deviation bargraph.
- Adjust display brightness.

Page header – **Display Page.**

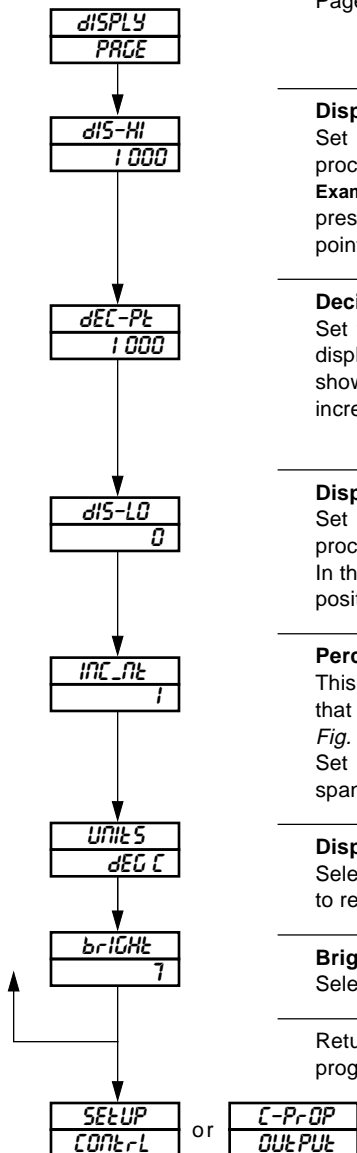

Display Full Scale

Set the display value which represents the maximum process variable input signal, between –9999 and +9999. **Example** – For an input range of 4 to 20mA representing a pressure range of 50 to 250 bar, set 2500. The decimal point position is set at the next parameter.

Decimal Point Position

Set the required number of decimal places for both the display full scale and display zero values. In the example shown above, set the decimal point position to show increments of 0.1 bar, i.e. 250.0.

Display Zero

Set the display value which represents the minimum process variable input signal, between –9999 and +9999. In the example shown above, set 50.0. The decimal point position is set automatically.

Percentage Increment Per Bar (Bargraph)

This frame sets the percentage deviation from set point that each bar of the **Deviation Bargraph** represents – see *Fig. 4.1 in the Operating Guide*.

Set the value required, between 1 and 10% of display span.

Display Units

Select the required display units, *deg C*, *deg F*, or *NONE* to represent the process variable.

Brightness Adjustment

Select the required display brightness between 4 and 10.

Return to top of **Display Page** or advance to the next programming page.

4.9 Current Proportioning Output Page

Information.

- This page is only present when *C-PrOP* is selected at **Control Type** frame in **Set Up Control Page** – see Fig. 3.1 and Section 4.10.
- Programmable current control output range.

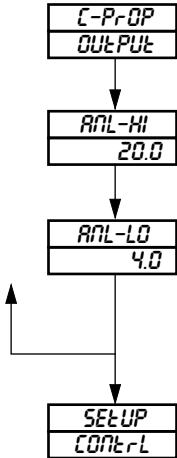

Page header – **Current Proportioning Output.**

Current Proportioning Output Maximum

Set the maximum analog output value, between 0.0 and 20.0mA in 0.1mA increments.

Current Proportioning Output Minimum

Set the minimum analog output value, between 0.0 and 20.0mA in 0.1mA increments.

Return to top of **Current Proportioning Output Page.**

or

Advance to **Set Up Control Page.**

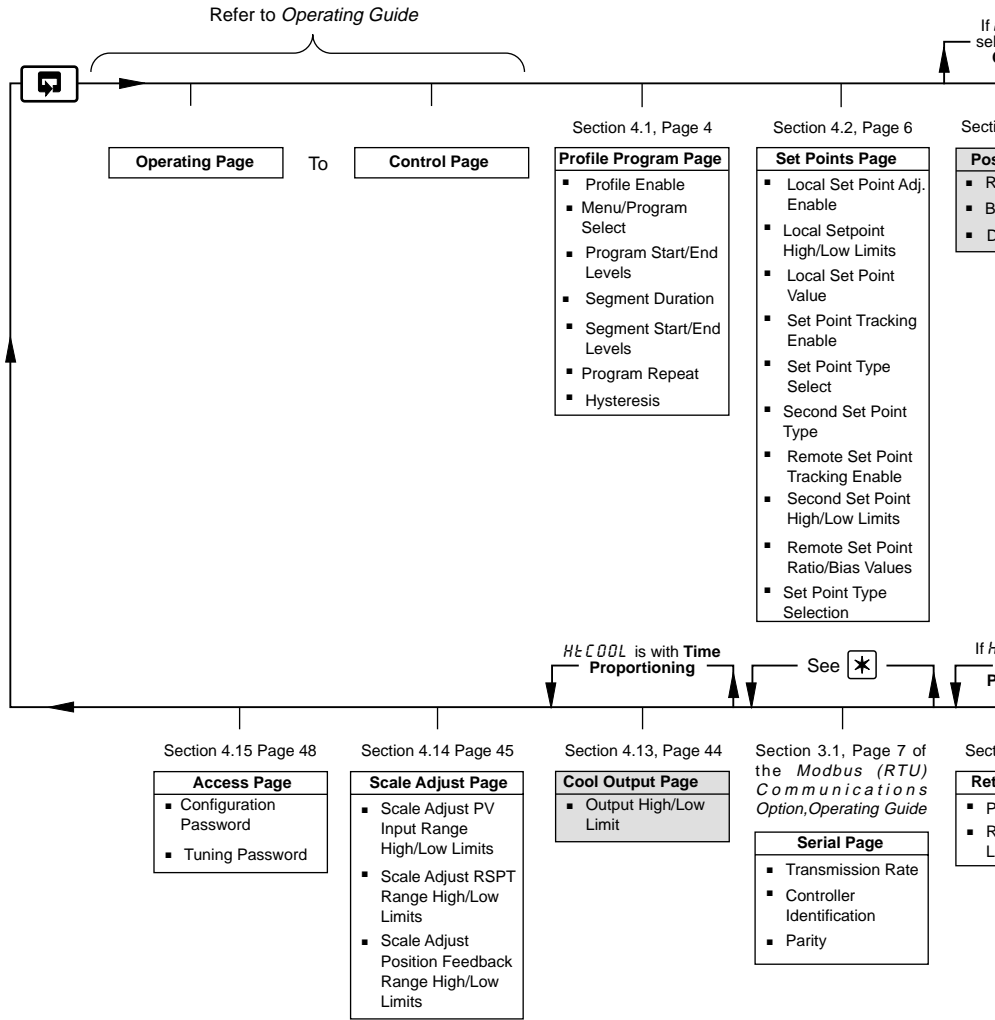

These pages are not displayed for all **Control Type** selections – see **Section 4.10, Control Type** frame in the **Set Up Control Page**

Note. The Serial Page is always displayed on COMMANDER 310 instruments and only displayed on COMMANDER 300 instruments if a serial board is fitted.

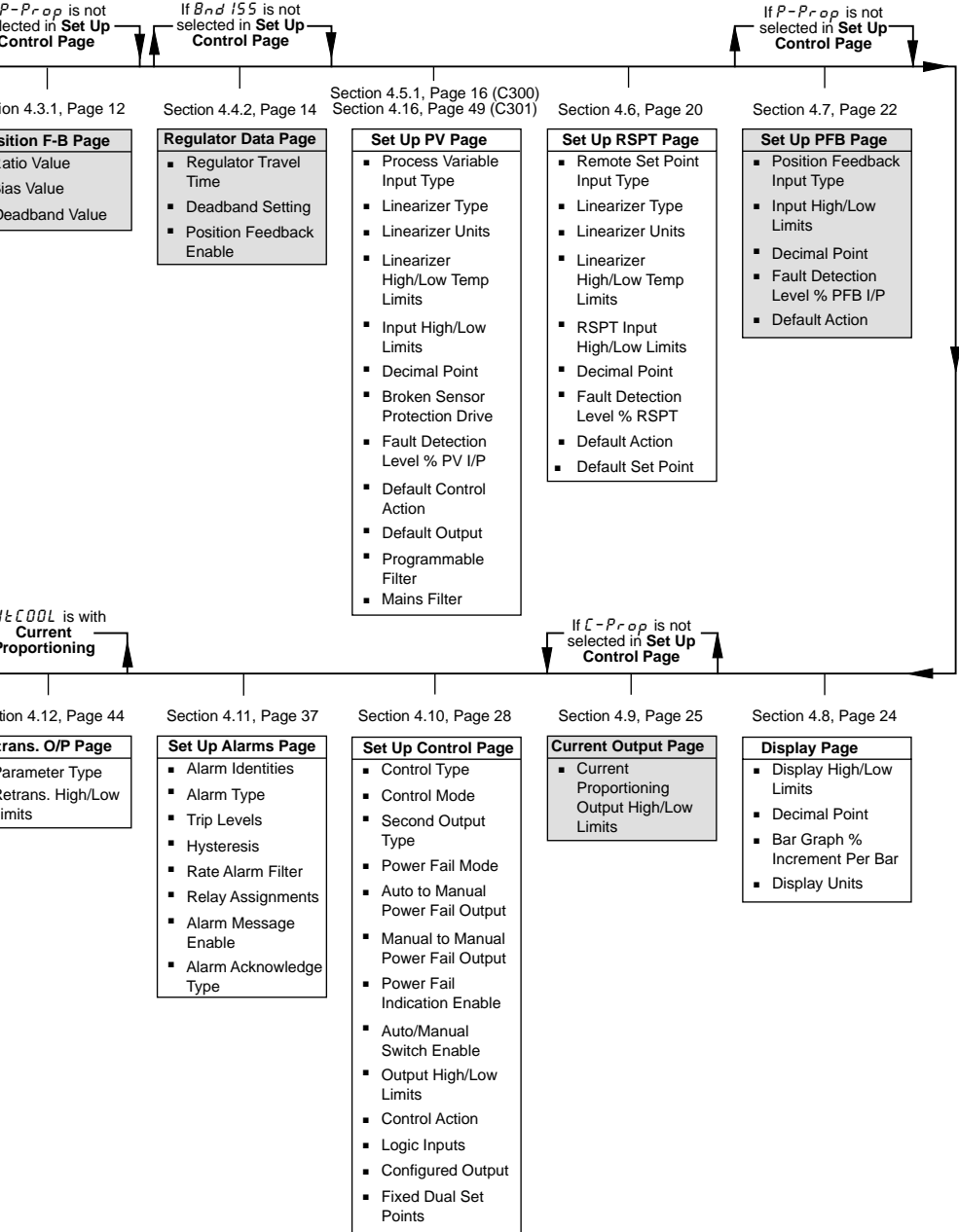

4.10 Set Up Control Page

Information.

- Control types – Current Proportioning, Time Proportioning (and On/Off), Position proportioning (motorized valve control with feedback) and Boundless.
- Heat/cool function can be selected.
- Programmable power-up control modes and outputs.
- Reverse and direct control actions.
- High and low output limits.

Page Header – **Set Up Control.**

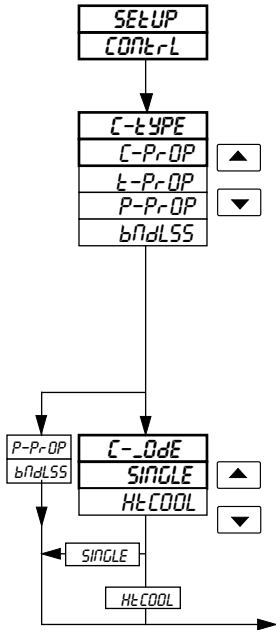

Control Type

Select the control type required:

C-PROP – current proportioning – see Fig. 4.4.

t-PROP – time proportioning – see Fig. 4.4.

P-PROP – position proportioning – motorized valve with position feedback – see Fig. 4.6.

bNDLSS – boundless – motorized valve without position feedback. If *bNDLSS* selected the self-tune facility is not available and the **Self-tune Page** cannot be accessed – see Fig. 4.7.

Control Mode

Select the control mode required:

SINGLE – normal control mode, used for all applications except Heat/Cool.

HEtCOOL – Heat/Cool control mode – see Fig. 4.5.

Continued on page 30.

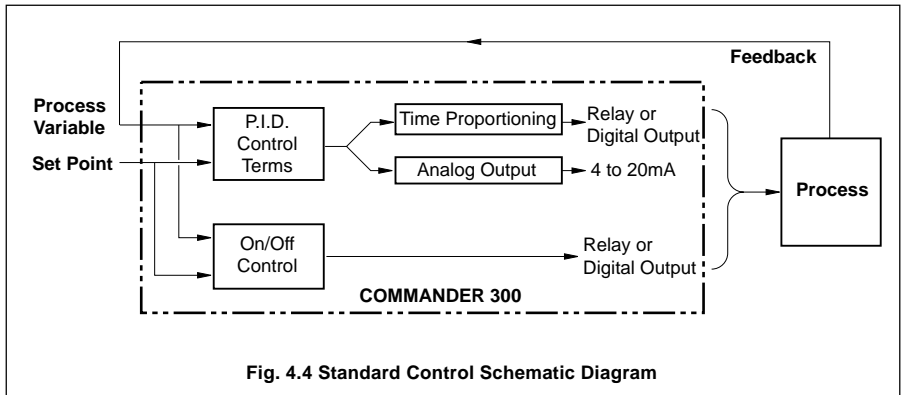
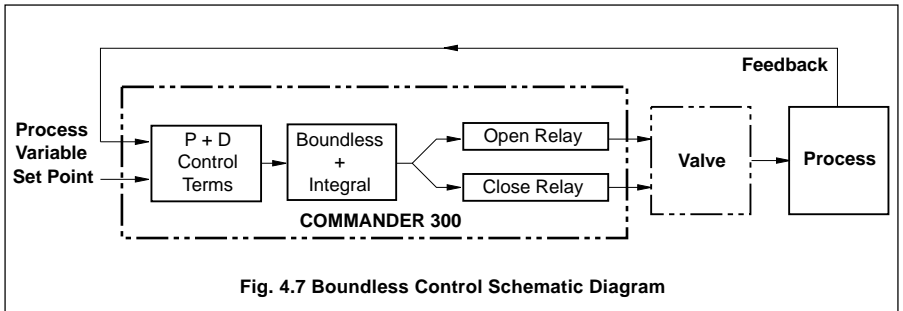
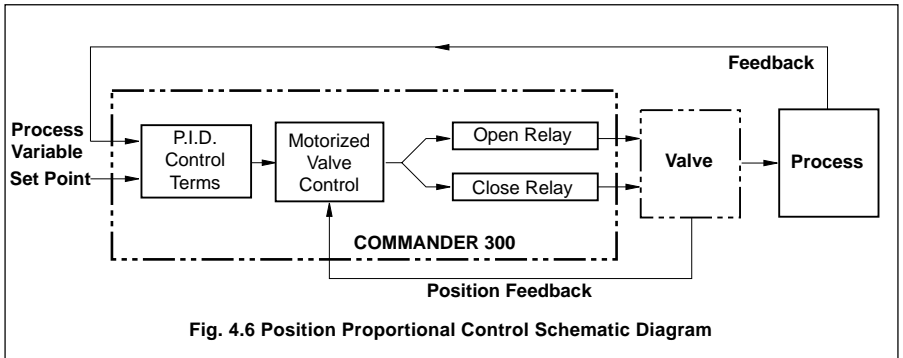
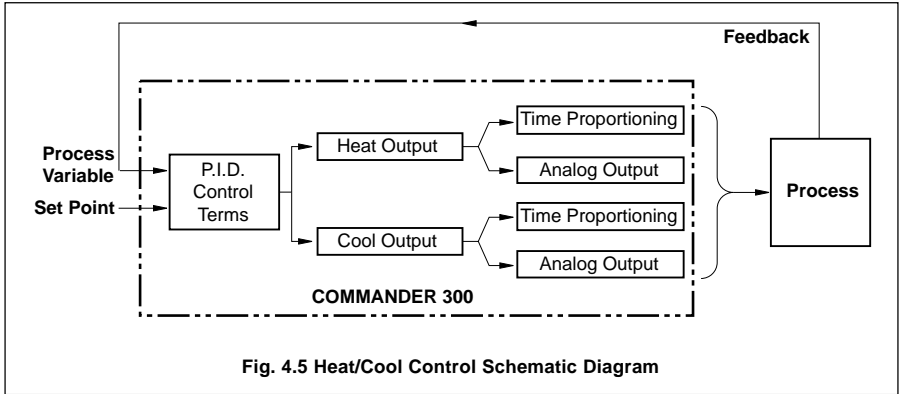
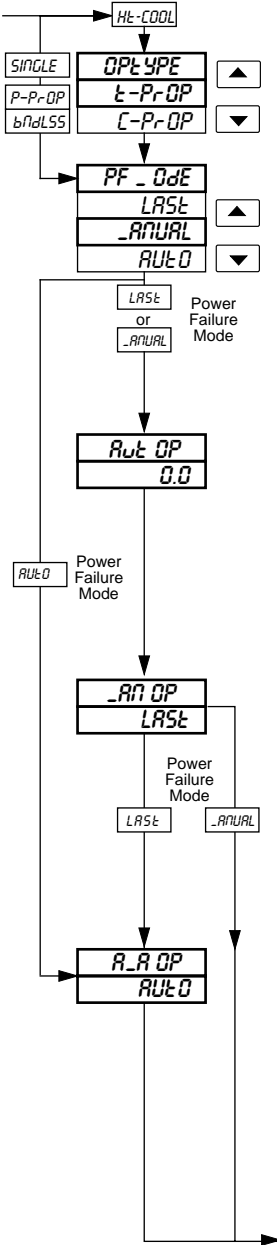

Fig. 4.4 Standard Control Schematic Diagram

...4.10 Set Up Control Page



...4.10 Set Up Control Page



Second Output Type

Select *t-P-OP* for time proportioning output or *C-P-OP* for analog output.

Power Failure Mode

Select the default power failure mode required following a power interruption or failure:

- LAsE* – restart in the same mode existing prior to power failure.
- _ANUAL* – restart in Manual mode. (Not applicable when boundless control type is selected).
- RuE0* – restart in Auto mode.

Auto to Manual Power Fail Output

A control output value can be set when the power down state is *RuE0* and the power failure mode is *_ANUAL*. Set the control output value required following a power failure, between 0.0 and 100.0% in increments of 0.1%.

Note. This setting has no effect if power failure mode is *RuE0*.

Manual to Manual Power Fail Output

This is the control output value required when power down state is *_ANUAL* and power failure mode is *_ANUAL*. Set the control output value required following a power failure, between 0.0 and 100.0% in increments of 0.1%, or *LAsE*.

- LAsE* – the percentage control output present prior to the power failure is retained.

Auto Power Fail Output

This is the output value required when the power down state is *RuE0* and the power failure mode is *RuE0*.

Set the output value required following a power failure, between 0.0 and 100.0% in increments of 0.1 %, or *RuE0*. If *RuE0* is selected normal start-up is restored on power up. If boundless control type is selected, this parameter must be set to *RuE0*.

Continued on next page.

...4.10 Set Up Control Page

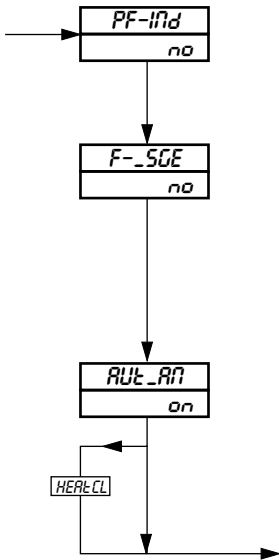

Power Fail Indication Enable

If the indication is enabled, *L I N E F A I L E d* is displayed in the **Operating Page** following a power failure. Select *Y E S* to enable or *n o* to disable indication.

Failure Message

The following **Operating Page** Failure messages can be enabled or disabled – see *Section 5.2 of Operating Guide*.

- F - I N P t* – process input failure
 - F - r S P t* – remote set point failure
 - F - P O S n* – position feedback failure
- Select *Y E S* to enable or *n o* to disable.

Auto/Manual Switch Enable/Disable

Select *o n* to enable, or *O F F* to disable.

If *H E A T C L* is selected at **Control Mode**, advance to **Control Action (Heat)**, otherwise advance to **Output High Limit**.

Continued on next page.

Power Fail Mode	Mode on Power Down	Mode on Power Up	Control Output (Valve Position on Power Up)
Auto	Auto	Auto	Integral component of the control output is preset to give bumpless operation at power-up at the value set in the Auto-to-Auto frame.
	Manual	Auto	Integral component of the control output is preset to give bumpless operation at power-up at the value set in the Manual-to-Auto frame (or LAST)
Manual	Auto	Manual	Value set in Auto-to-Manual Output frame (or LAST)
	Manual	Manual	Value set in Manual-to-Manual Output frame or output value prior to power-down (if LAST selected)
Last	Auto	Auto	Integral component of the control output is preset to give bumpless operation at power-up at the value set in the Auto-to-Auto frame (or LAST)
	Manual	Manual	Value set in Manual-to-Manual Output frame or output value prior to power-down (if LAST selected)

Table 4.3 Power-up and Power-down Control Modes

...4.10 Set Up Control Page

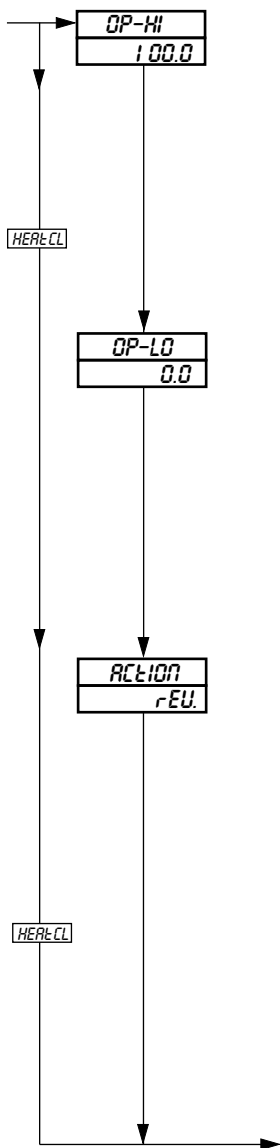

Output High Limit

This limits the high level of the control output value (or valve position) when in Automatic mode. If the control output is above this limit when Automatic mode is selected, the output is allowed to stay at its current level but is not allowed to go any higher. Once the control output returns to, or below, this limit the limit then applies. When the controller is in Manual mode the output limits do not apply.

Select the output high limit value (or valve position) required, between 0.0 and 100.0% in 0.1 increments.

Output Low Limit

This limits the low level of the control output value (or valve position) when in Automatic mode. If the control output is below this limit when Automatic mode is selected, the output is allowed to stay at its current level but is not allowed to go any lower. Once the control output returns to, or above, this limit the limit then applies. When the controller is in Manual mode the output limits do not apply.

Select the output low limit value (or valve position) required, between 0.0 and 100.0% in 0.1 increments.

Control Action

Select the action for the P.I.D. control output:

- d , r* - direct acting
- rEU.* - reverse acting.

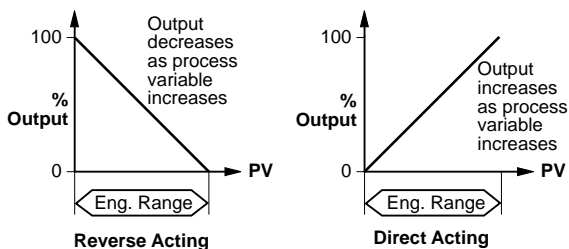

Continued on next page.

...4.10 Set Up Control Page

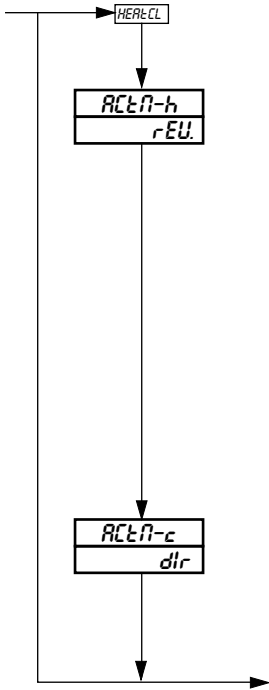

If **HEATCL** was selected at **Control Mode**, advance to **Control Action (Heat)**, otherwise advance to **Logic Input Type 1**.

Control Action (Heat)

Select the action for the heat and P.I.D. control outputs:

- dir* - direct acting
- rEU* - reverse acting.

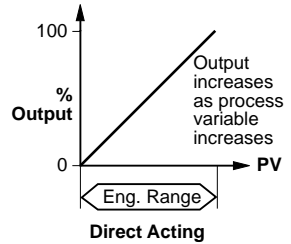
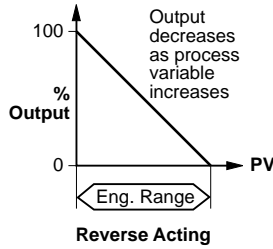

Control Action (Cool)

Select the action for the cool control output:

- dir* - direct acting
- rEU* - reverse acting.

Continued on next page.

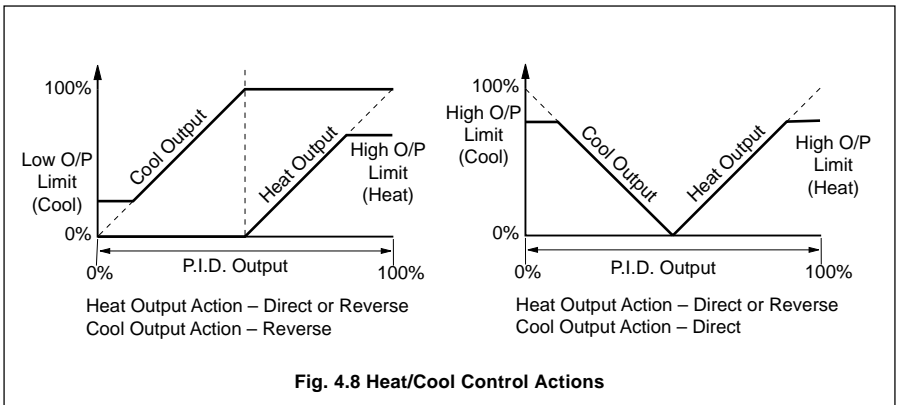
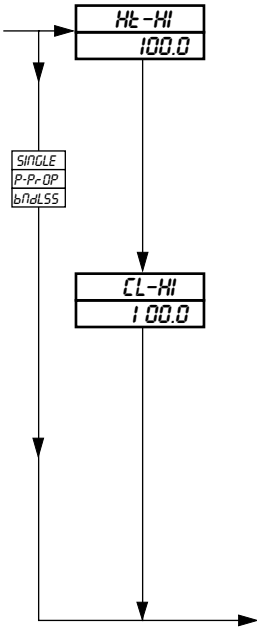

Fig. 4.8 Heat/Cool Control Actions

...4.10 Set Up Control Page



Heat Output High Limit

This limits the high level of the Heat control output value when in Automatic mode. If the control output is above this limit when Automatic mode is selected, the output is allowed to stay at its current level but is not allowed to go any higher. Once the control output returns to, or below, this limit the limit then applies. When the controller is in Manual mode the output limits do not apply. Select the heat output high limit value required, between 0.0 and 100.0% in 0.1 increments.

Cool Output High/Low Limit

This limits the high or low level of the Cool control output when in Automatic mode, depending on the **Control Action (Cool)** frame setting (*rEU* is the low and *dIr* is the high setting). If the control output exceeds this limit when Automatic mode is selected, the output remains at its current level but is not allowed to go any further away from the limit. Once the control output returns to, or within, this limit, the limit then applies. When the controller is in Manual mode the output limits do not apply. Select the Cool output high (low) limit required, between 0.0 and 100.0% in 0.1 increments.

Continued on the next page.

...4.10 Set Up Control Page

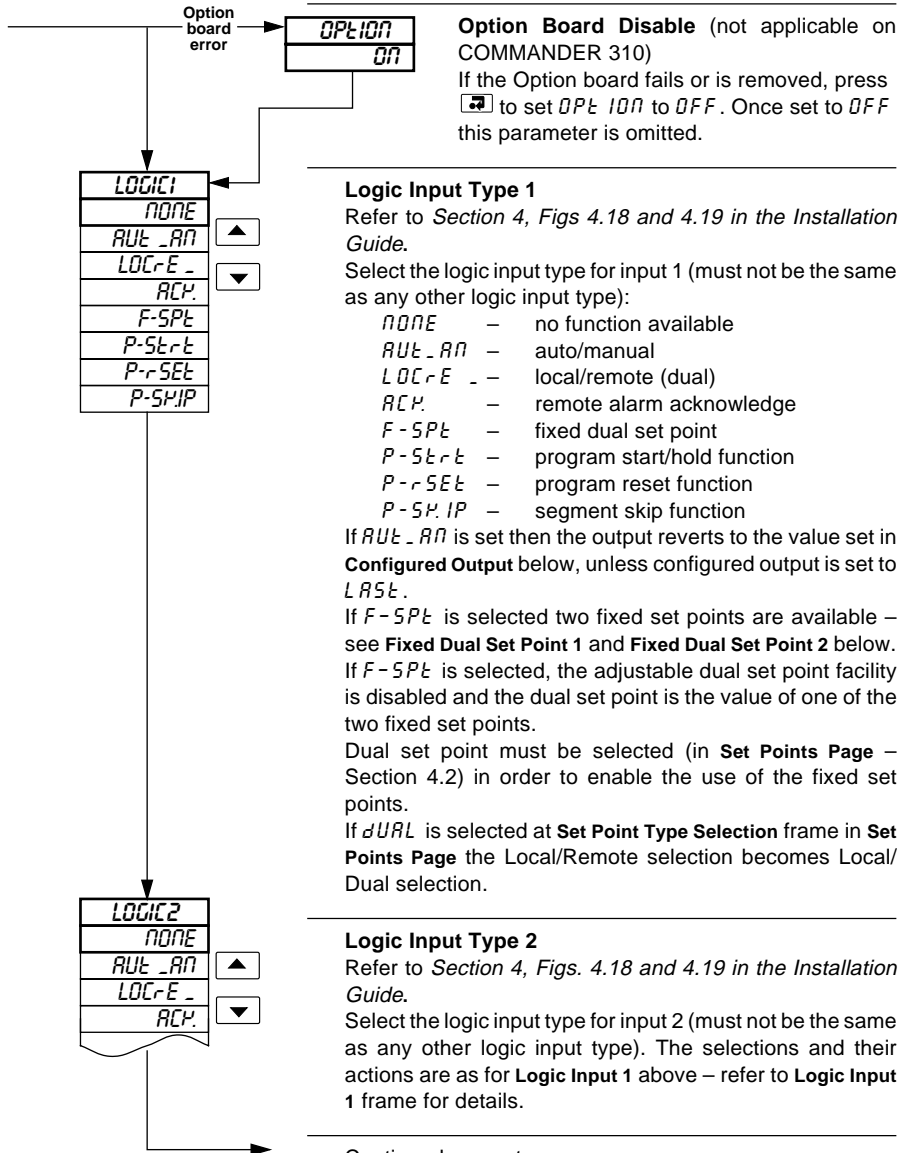

...4.10 Set Up Control Page

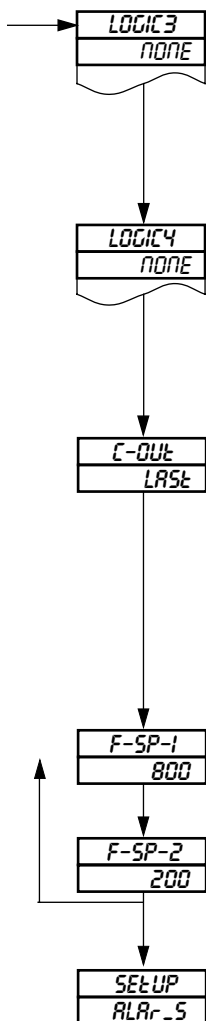

Logic Input Type 3 (not available on COMMANDER 310)
Refer to Section 4, Figs. 4.18 and 4.19 in the Installation Guide.

Select the logic input type for input 3 (must not be the same as any other logic input type). The selections and their actions are as for **Logic Input 1** – refer to **Logic Input 1** frame for details.

Logic Input Type 4 (not available on COMMANDER 310)
Refer to Section 4, Figs. 4.18 and 4.19 in the Installation Guide.

Select the logic input type for input 4 (must not be the same as any other logic input type). The selections and their actions are as for **Logic Input 1** – refer to **Logic Input 1** frame for details.

Configured Output

Select the configured output, between 0.0 and 100.0% in 0.1% increments, or *LAST*.

If *MAN* is selected for any of the logic inputs above, the manual control output equals the **Configured Output**, unless the configured output is *LAST*.

LAST – last auto output, i.e. the manual output tracks the automatic output. Found below 0%.

Fixed Dual Set Point 1

If the selection in any of the four logic inputs is *F-SP1* a fixed set point may be set. Set the fixed set point required.

Fixed Dual Set Point 2

If the selection in any of the four logic inputs is *F-SP2* a fixed set point may be set. Set the fixed set point value required.

Return to the top of **Set Up Control Page** or advance to the next programming page.

4.11 Set Up Alarms Page

Information.

- Ten alarms – identified A to K.
- Three operator acknowledge options.
- Global alarm acknowledgment by digital input, alarm, logic equation result or real time event (if option fitted).
- High/low process alarms.
- High/low output alarms.
- High/low deviation alarms.
- Fast/slow rate of change of process variable alarms.
- Adjustable hysteresis value to prevent oscillation of alarm state.

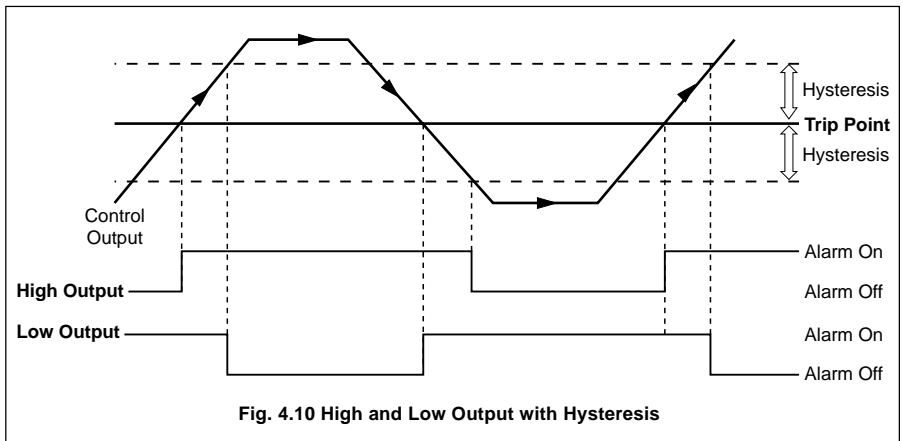
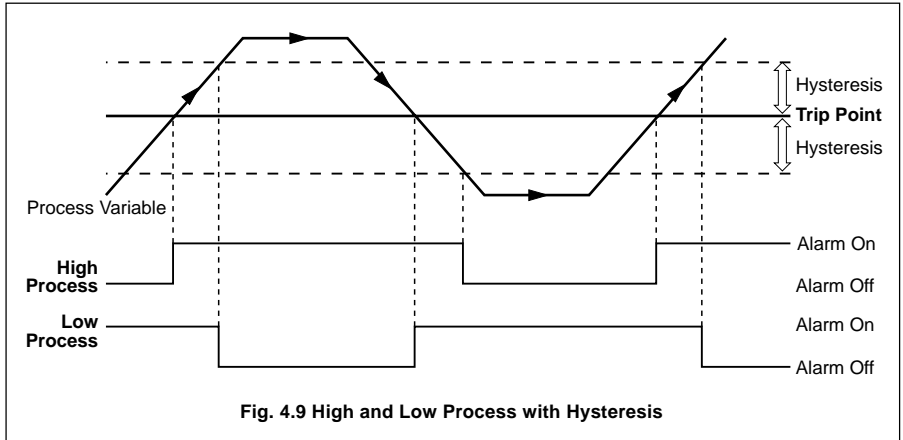

...4.11 Set Up Alarms Page

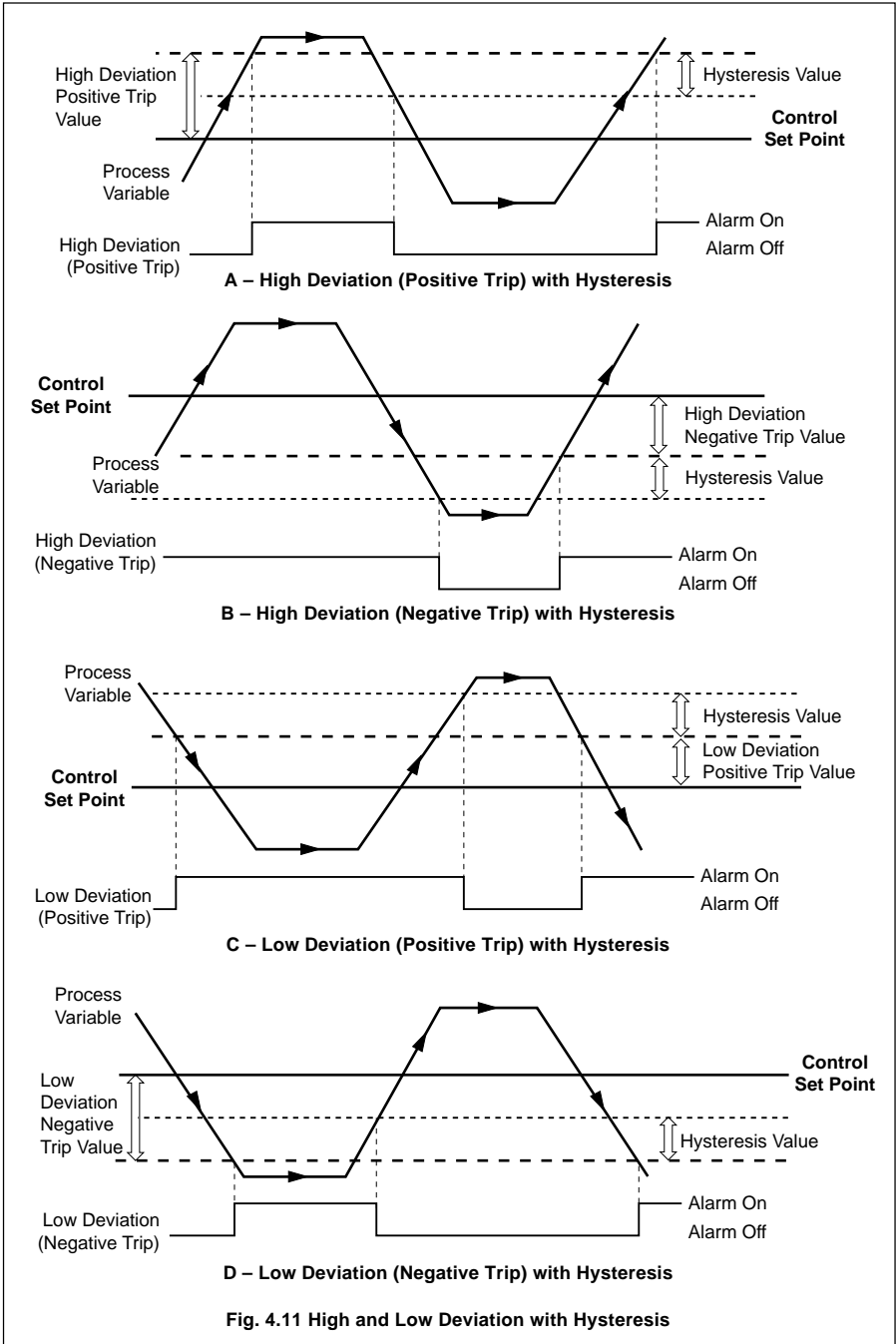
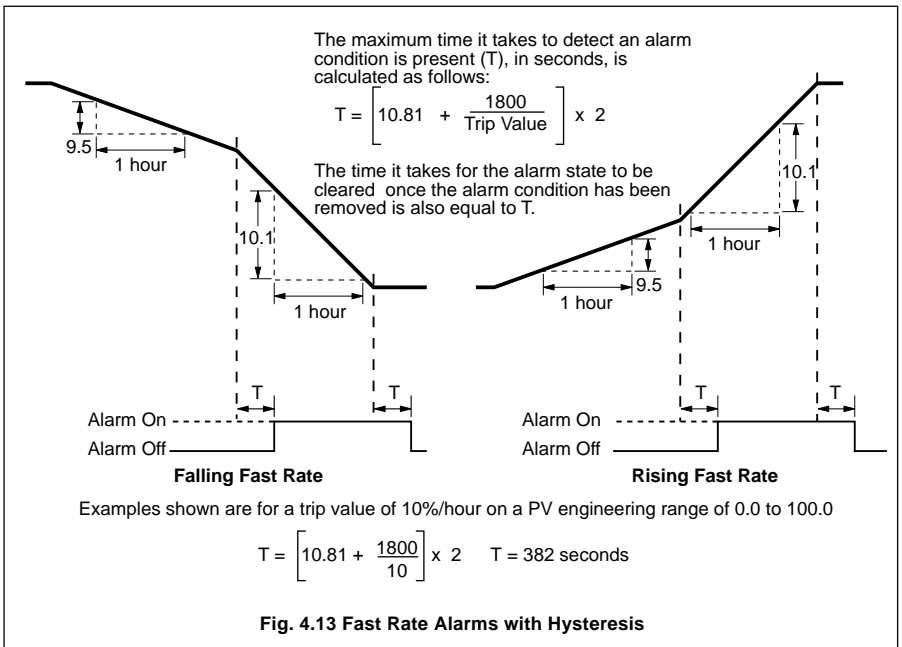
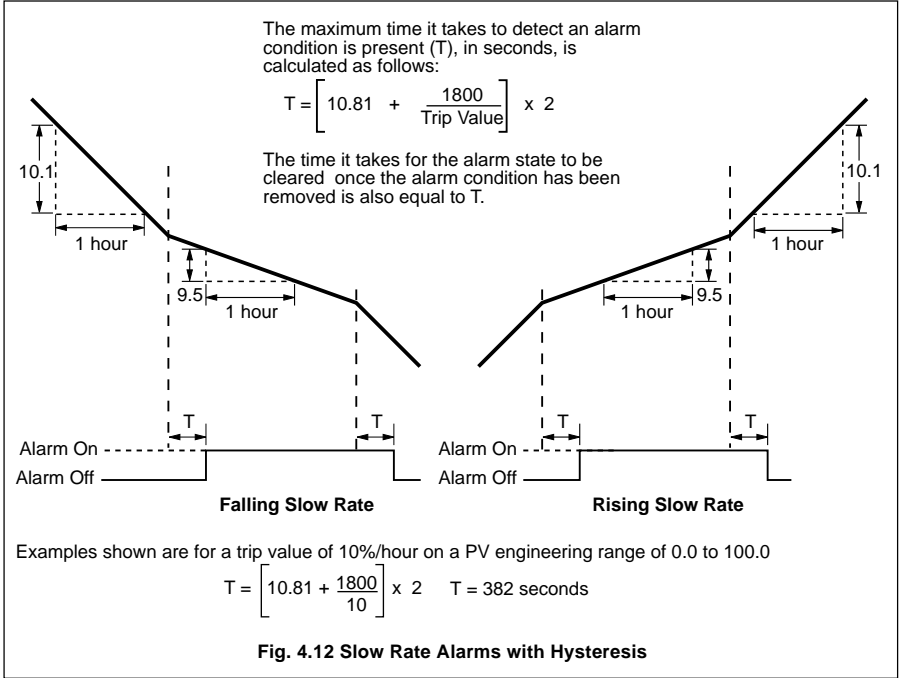
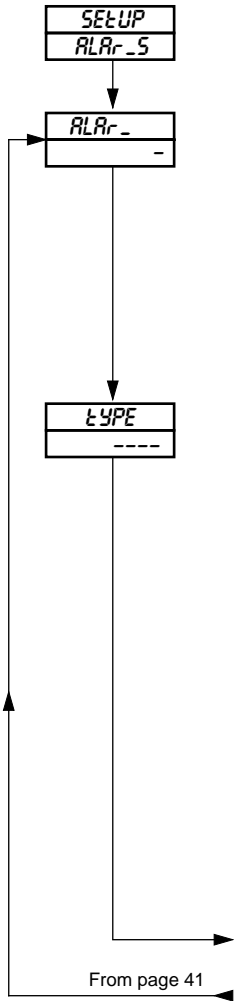

Fig. 4.11 High and Low Deviation with Hysteresis

...4.11 Set Up Alarms Page



...4.11 Set Up Alarms Page



Page Header – **Set Up Alarms.**

Alarm Identities

Up to ten alarms (A to K but not I) can be programmed. Each alarm can be assigned an Alarm Type, a Trip Level and a Hysteresis setting. Alarm A is the highest priority and K the lowest.

Note. The alarm status i.e.d. indicators are:

- A1 – alarms A to E
- A2 – alarms F to K.

Select the Alarm identity.

Alarm Type

An alarm type can be assigned to the alarm identity selected above – Refer to Figs. 4.9 to 4.13.

Select the alarm type:

- NONE* – no alarm function
- HPrC* – high process
- LPrC* – low process
- HdEU.* – high deviation
- LdEU.* – low deviation
- HOUt* – high output
- LOUt* – low output
- Fr&E* – fast rate
(rate of change of process variable)
- Sl&E* – slow rate
(rate of change of process variable)
- _OdE* – mode alarm
- PEU.t* – program event
- SEU.t* – segment event

(a) Continued on next page.

(b) From **More Alarms to be Programmed** frame.

...4.11 Set Up Alarms Page

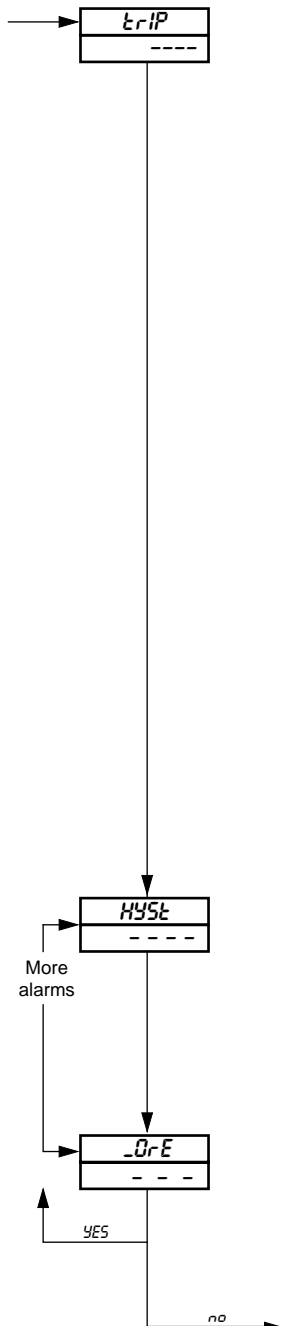
**Trip Level**

Set the trip value required for the alarm selected above.

The following are displayed in engineering units:

HPrc, *LPrc*, *HdEU* and *LdEU*.

HdEU and *LdEU* alarms have both positive and negative trip points. Refer to Fig. 4.11.

The following are displayed as percentages:

HOUt and *LOUt*.

The following are displayed as a percentage of span per hour between ± 0.5 and $\pm 500\%$:

FrtE and *SrtE*.

The following are displayed as event numbers:

PEUt (1 to 9) and *SEUt* (1 to 30).

If the **Alarm Type** is set to *_DdE* the displayed characters are alpha, not numeric. The following codes are selectable:

- AUtd* – Automatic
- _ANUAL* – Manual
- L-SPt* – Local set point
- r-SPt* – Remote set point – only selectable if Second set point type is Remote set point
- dSPt* – Dual set point– only selectable if Second set point type is Dual set point
- PURFAL* – process variable failure
- rSFRAL* – Remote set point failure
- PNFRAL* – position feedback failure
- INFRAL* – any input failure
- P-HOLD* – alarm activated when program is on Hold (Profile only)

If *AUtd*, *_ANUAL*, *L-SPt*, *r-SPt*, or *d-SPt* is selected and an attempt is made to use that facility (Automatic, Manual, Local set point, Remote set point, or Dual set point) the alarm is activated.

Hysteresis

The hysteresis is operational when the alarm is active.

Set the hysteresis value required (in engineering units), between display full scale and zero, or percentage rate set on rate alarms, in 0.1% increments. The alarm is activated at the trip level but is only turned off after the alarm variable has moved into the safe region by an amount equal to the hysteresis value. Refer to Figs. 4.9 to 4.13.

More Alarms to be Programmed?

If there are, select *YES* otherwise select *no*.

Return to **Alarm Identities** frame, or advance to the next parameter.

Continued on next page

...4.11 Set Up Alarms Page

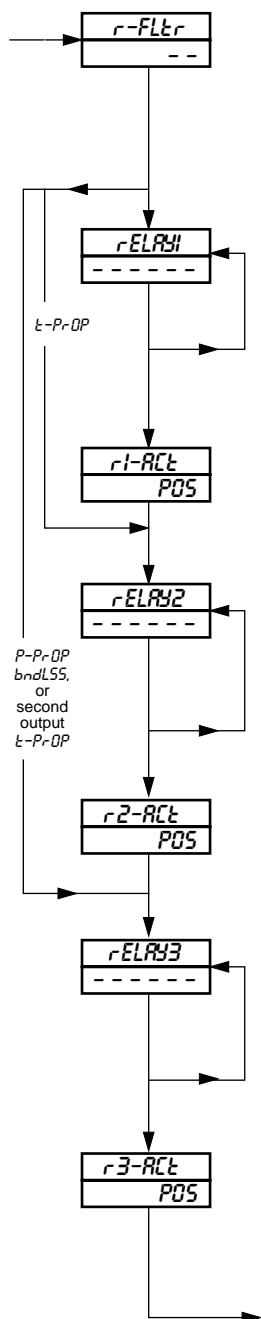

Rate Alarm Filter

The process variable input can be filtered before its rate of change is calculated to activate any fast or slow rate alarms. The filter time represents the time a step in the input takes to change the input to the rate alarm from 10 to 90% of the step. Set value required, between 0 and 60 in 1 second increments.

Alarm Relay 1 Assignment

Up to 6 of the 10 alarms can be assigned to alarm relay 1, using a logic expression of up to 12 characters. (*r* = logic OR, *n* = logic AND, *[]* are brackets and *;* is the terminator).

Select the next character in the expression.

Press to store the character and return to select the next character or press to advance to the next frame.

Relay 1 Action

Select *POS* for the relay to be energised when the logic expression is satisfied. Select *NEG* for the relay to be de-energised when the logic expression is satisfied.

Alarm Relay 2 Assignment

Up to 6 of the 10 alarms can be assigned to alarm relay 2, using a logic expression of up to 12 characters. (*r* = logic OR, *n* = logic AND, *[]* are brackets and *;* is the terminator).

Select the next character in the expression.

Press to store the character and return to select the next character or press to advance to the next frame.

Relay 2 Action

Select *POS* for the relay to be energised when the logic expression is satisfied. Select *NEG* for the relay to be de-energised when the logic expression is satisfied.

Alarm Relay 3 Assignment

Up to 6 of the 10 alarms can be assigned to alarm relay 3, using a logic expression of up to 12 characters. (*r* = logic OR, *n* = logic AND, *[]* are brackets and *;* is the terminator). Select the next character in the expression.

Press to store the character and return to select the next character or press to advance to the next frame.

Relay 3 Action

Select *POS* for the relay to be energised when the logic expression is satisfied. Select *NEG* for the relay to be de-energised when the logic expression is satisfied.

Continued on next page.

...4.11 Set Up Alarms Page

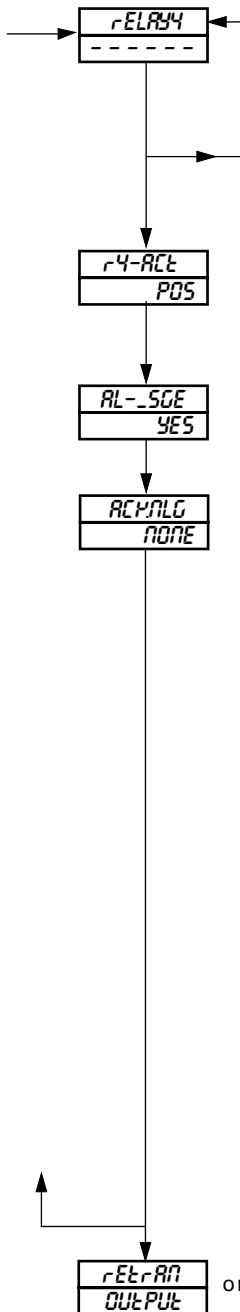

Alarm Relay 4 Assignment (not available on COMMANDER 310)

Up to 6 of the 10 alarms can be assigned to alarm relay 4, using a logic expression of up to 12 characters. (*r* = logic OR, *n* = logic AND, *[]* are brackets and *⏏* is the terminator).

Select the next character in the expression.

Press **[]** to store the character and return to select the next character or press **[⏏]** to advance to the next frame.

Relay 4 Action (not available on COMMANDER 310)

Select *POS* for the relay to be energised when the logic expression is satisfied. Select *NEG* for the relay to be de-energised when the logic expression is satisfied.

Alarm Message Enable

Set *YES* to enable, or *no* to disable the display of alarm messages in the **Operating Page**.

Alarm Acknowledge Type

Alarms may be acknowledged while they are displayed.

Select the alarm acknowledge type:

none – no acknowledge facility.

nor-RL – If the cause of the alarm no longer exists, the alarm still clears, but the display remains until alarm is acknowledged.

Alarm cause	Acknow.	Display	LED	Alarm State
Present	–	Flashing	Flashing	Active
Present	Yes	–	Steady	Active
Not present	–	–	Off	Inactive
Present	–	Flashing	Flashing	Active
Not present	–	Flashing	Off	Inactive
Not present	Yes	–	Off	Inactive

LATCH – if the cause of the alarm no longer exists, the alarm state remains until it has been acknowledged.

Alarm cause	Acknow.	Display	LED	Alarm State
Present	–	Flashing	Flashing	Active
Present	Yes	–	Steady	Active
Not present	–	–	Off	Inactive
Present	–	Flashing	Flashing	Active
Not present	–	Flashing	Flashing	Active
Not present	Yes	–	Off	Inactive

Return to top of **Set Up Alarms Page** or advance to next programming page.

4.12 Retransmission Output Page

Information.

- Retransmission of process variable, set point, control output or position feedback input.
- Programmable current output range.
- Retransmission output can be used for cool output in heat/cool applications.

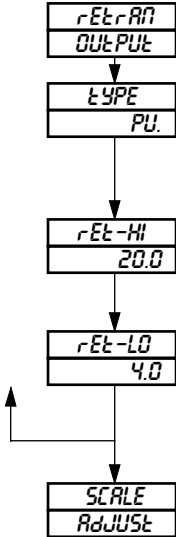

Page Header – **Retransmission Output.**

Parameter Type

Select the parameter type to be re-transmitted, *PU* (process variable input), *SPt* (set point), *OUT* (output) or *PFb* (position feedback).

Retransmission Maximum

Set the maximum retransmission value, between 0.0mA and 20.0mA in 0.1mA increments.

Retransmission Minimum

Set the minimum retransmission value, between 0.0mA and 20.0mA in 0.1mA increments.

Return to top of **Retransmission Output Page**
or
Advance to **Scale Adjustment Page.**

4.13 Cool Output Page

This page is only present if *HECOOL* is selected at **Control Mode** and *C-ProP* is selected at **Second Output Type** in the **Set Up Control Page** – see Fig. 3.1 and Section 4.10.

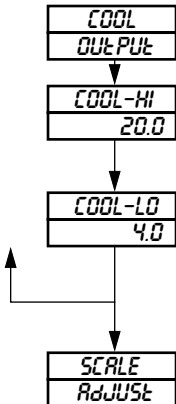

Page Header – **Cool Output Page**

Cool Output Maximum

Set the maximum value for the cool output, between 0.0mA and 20.0mA in 0.1mA increments.

Cool Output Minimum

Set the minimum value for the cool output, between 0.0mA and 20.0mA in 0.1mA increments.

Return to top of **Cool Output Page**
or
advance to **Scale Adjustment Page.**

4.14 Scale Adjustment Page

Information.

- Process variable, Remote set point and position feedback inputs do not require recalibrating when the input type or range is changed.
- Scale Adjustment Reset – removes any previously programmed offset or scale adjustment settings.
- System offset errors – can be removed using Offset Adjustment.
- System scale errors – can be removed using Span Adjustment.
- Offset/Span Adjustment – can be used to perform spot calibration.

Switch off the power supply. Connect accurate signal sources, suitable for simulation over the entire input ranges, in place of the process variable signal connections (terminals 10, 11, 12), remote set point signal connections (terminals 7, 8 and 9) and position feedback connections (terminals 4, 5 and 6). For thermocouple inputs, connect the millivolt source using appropriate compensating cable – see *Section 4.6.1 of the Installation Guide*. For 2-lead resistance thermometers the resistance box may be connected at the sensor end of the leads or the lead resistance must be added to the calibration values.

As a general rule, spot calibration values should be:

- < 50% of range span value when using Offset Adjustment parameters.
- > 50% of range span value when using Span Adjustment parameters.

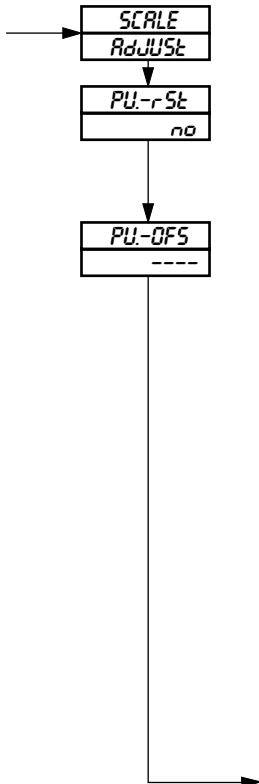

Page header – **Scale Adjustment**

Process Variable Scale Adjustment Reset

Set *YES* and press **[↵]** to reset the process variable offset and span values to their nominal values. *DONE* is displayed to indicate that these parameters have been reset.

Process Variable Offset Adjustment

Electrical and resistance thermometer inputs:

Apply the correct input for the spot calibration required. For RTD inputs, use resistance values obtained from standard tables.

Thermocouple Inputs:

Measure the ambient temperature at the output terminals of the signal source (calibrator). From thermocouple tables obtain the millivolt equivalent of this temperature (a) and that for the spot calibration temperature (b). Subtract (a) from (b) and set the signal source to the resultant value. (The voltage is negative if the spot calibration temperature is below the measured ambient temperature).

Note. The displayed units are engineering units.

Set the value required. The decimal point position is set automatically.

Example – If the display range is 50 to 250.0 and a spot calibration is required at 100.0 and 225, inject a signal equivalent to 100 and set the display to 100.0.

Continued on next page.

4.14 Scale Adjustment Page

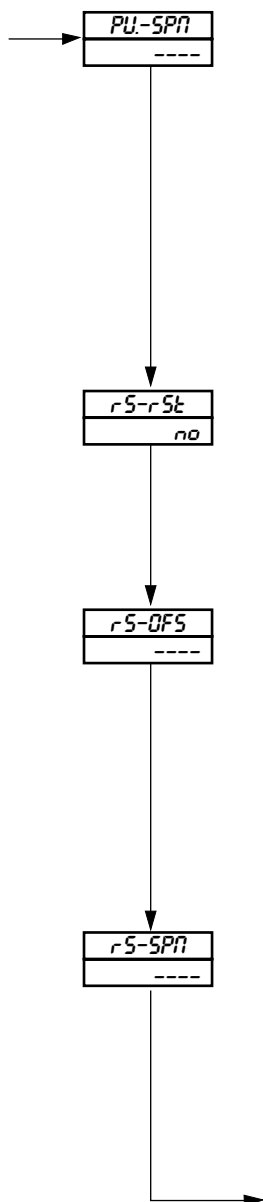

Process Variable Span Adjustment

Proceed as for **Process Variable Offset Adjustment** and apply the correct input for the spot calibration required. The displayed units are engineering units.

Set the value required. The decimal point position is set automatically.

For the Example above inject a signal equivalent to 225.0 and set the display to 225.0.

Advance to **Position Feedback Scale Adjustment Reset** frame (instruments where remote set point is not selected – see **Set Point Selection** frame in **Set Points Page**) or advance to next frame (instruments with remote set point selected).

Remote Set Point Scale Adjustment Reset

The next three parameters are only included if the Remote set point facility is selected.

Set to *YES* and press  to reset the Remote set point offset and span adjustments to their nominal values. *DONE* is displayed to indicate that these parameters have been reset.

Remote Set Point Offset Adjustment

Proceed as for **Process Variable Offset Adjustment** frame and apply the correct input for the spot calibration required. The displayed units are engineering units as set in **Set Up Remote Set Point Page** – see Section 4.6.

Set the value required. The decimal point position is set automatically.

Example – If the remote set point range (see Section 4.6) is 50.0 to 250.0 and a spot calibration is required at 100.0 and 225, inject a signal equivalent to 100 and set the display to 100.0.

Remote Set Point Span Adjustment

Proceed as for **Process Variable Span Adjustment** frame and apply the correct input for the spot calibration required. Ratio and bias settings are ignored. The displayed units are engineering units as set in **Set Up Remote Set Point Page** – see Section 4.6.

For the example above, inject a signal equivalent to 225 and set the display to 225.0.

Continued on next page.

4.14 Scale Adjustment Page

The next three parameters are only included if the position feedback facility is selected.

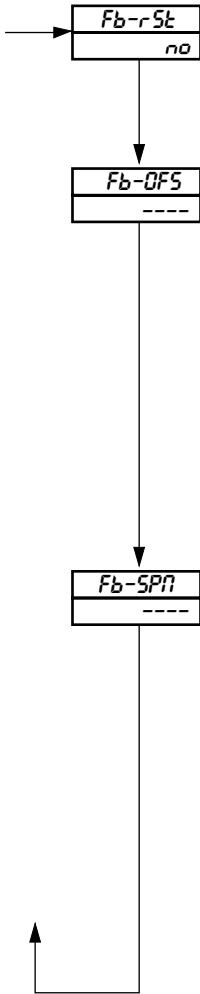

Position Feedback Scale Adjustment Reset

Set to *YES* and press to reset the position feedback offset and span adjustments to their nominal value. *DONE* is displayed to indicate that these parameters have been reset.

Position Feedback Offset Adjustment

Proceed as for **Process Variable Offset Adjustment** frame and apply the correct input for the spot calibration required. Ratio and bias settings are ignored.

Set the value required. The decimal point position is set automatically. For resistance inputs use the external connections to drive the valve to the fully closed position.

Adjust or to bring the value displayed to that set in **Position Feedback Range Zero** frame in the **Set Up Position Feedback Page**. If this value cannot be reached, adjust the value in **Position Feedback Range Zero** frame to bring it within the offset bandwidth of $\pm 10\%$.

Position Feedback Span Adjustment

Proceed as for **Process Variable Span Adjustment** frame and apply the correct input for the spot calibration required. Ratio and bias settings are ignored.

Set the value required. The decimal point position is set automatically. For resistance inputs use the external connections to drive the valve to the fully open position.

Adjust or to bring the value displayed to that set in **Position Feedback Range Full Scale** frame in the **Set Up Position Feedback Page**. If this value cannot be reached, adjust the value in **Position Feedback Range Full Scale** frame to bring it within the span bandwidth of $\pm 10\%$.

Return to the top of the **Scale Adjustment Page**.

4.15 Access Page

Information.

- **Tune Password** – protects the control settings and prevents unauthorized use of self-tuning.
- **Configuration Password** – protects the controller configuration setup.

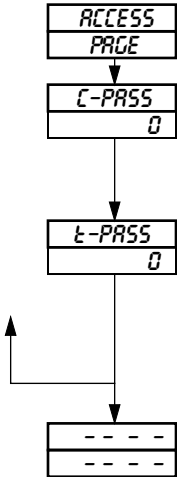

Page Header – **Access Page.**

Configuration Password

The configuration password enables access to all programming pages (Security Level 2). Set the required password, between 0 and 1999.

Tuning Password

The tuning password enables access to the **Self-tune, Control, Profile States** and **Profile Operating Pages** in addition to the **Operating Page** (Security Level 1). Set the required password, between 0 and 1999.

Return to top of **Access Page**

or

return to **Operating Page** – see *Section 5.2 of Operating Guide.*

4.16 Set Up Process Variable Input Page (COMMANDER 301 only)

Information.

- This information is only for the COMMANDER 301 when the custom linearizer function is used. For normal input setting up, refer to Section 4.5.
- Up to 20 breakpoint custom linearizer.
- Cold junction compensation for thermocouple inputs.

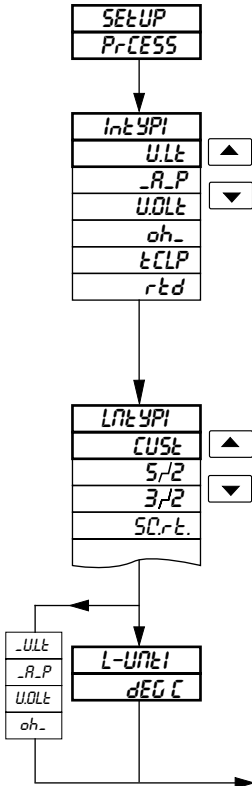

Page Header – Set Up Process Variable Input.

Process Variable Input Type

Select the input type required:

- _ULt – Millivolt (≤ 2000 mV)
- _A_P – Current
- UDLt – Voltage
- oh_ – Resistance
- tCLP – Thermocouple*
- rtd – Resistance thermometer

*For thermocouple applications using an external fixed cold junction, select millivolt input type.

Linearizer Type

Select the custom linearizer:

- CUSL – Custom linearizer

Linearizer Units

If thermocouple or RTD was selected for **Process Variable Input Type**, select the temperature units required, °C or °F.

Continued on next page.

...4.16 Set Up Process Variable Input Page (COMMANDER 301 only)

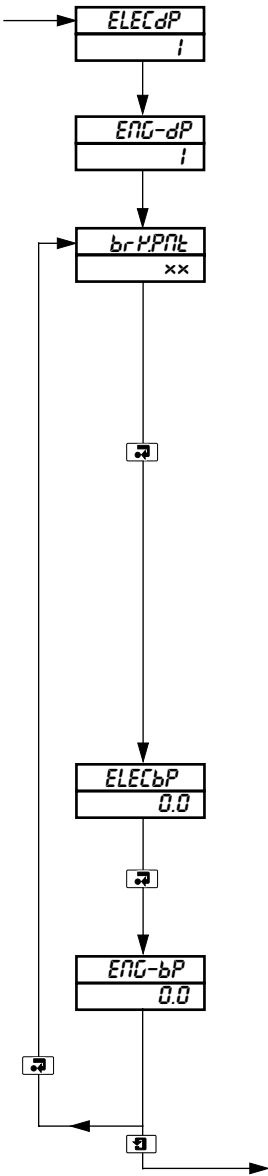

Electrical Decimal Point

Enter the number of decimal point positions required for the electrical input range (0 to 2).

Engineering Decimal Point

Enter the number of decimal point positions required for the engineering temperature range (0 to 3).

Break Point Selection

Select the break point to be set up and press to move to **Electrical Break Point**.

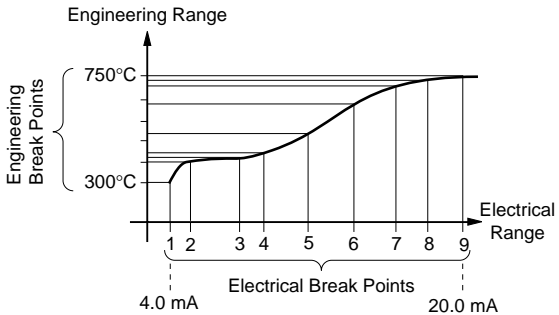

Note. The engineering range (display range) is set automatically and cannot be adjusted.

Electrical Break Point

Enter the value in electrical units (Millivolts, Milliamps, Ohms or Volts), for the break point selected above. It is not necessary to enter all 20 break points. The instrument ignores any break point that has an electrical value lower than the previous one and all the break points which follow it.

Engineering Break Point

Enter the value in engineering units for the break point selected above.
Press to return to the break point selection frame. Note that the break point selected will automatically be increased to the next one when this is done.

Continued on the next page.

...4.16 Set Up Process Variable Input Page (COMMANDER 301 only)

For Thermocouple Inputs

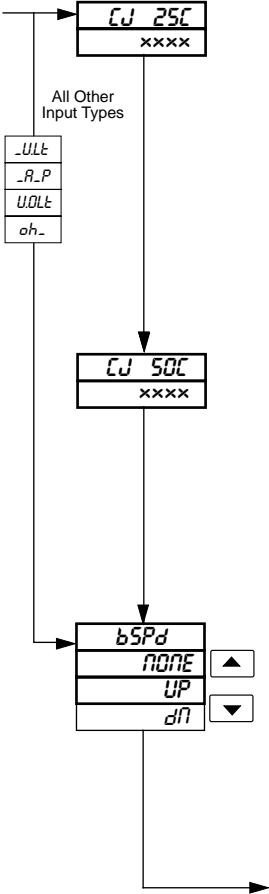

Cold Junction

If a thermocouple input was selected:

CJ J1 Enter the cold junction compensation offset at 25°C/ 77°F in microVolts.

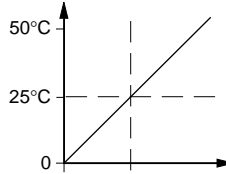

This feature allows automatic temperature compensation of thermocouple inputs. It is assumed that the thermocouple is referenced to 0 Millivolts at 0°C (32°F).

CJ J2 Enter the cold junction compensation offset at 50°C/122°F in microVolts.

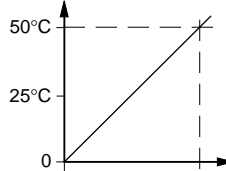

This feature allows automatic temperature compensation of thermocouple inputs.

Broken Sensor Protection Drive

In the event of a fault being detected on the input, the process variable is driven in the direction of the mode selected.

Select the broken sensor drive required:

- none* - No drive
- UP* - Upscale drive
- dN* - Downscale drive.

Continued on the next page.

...4.16 Set Up Process Variable Input Page (COMMANDER 301 only)

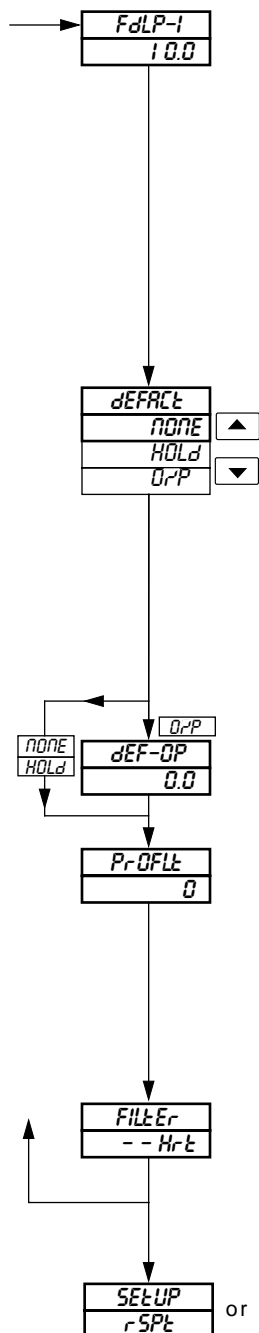

Fault Detection Level Percentage, Process Variable Input

A fault level percentage can be set to detect a deviation above or below the display limits, e.g. If set at 10.0%, then if an input goes more than 10% above full scale value or more than 10% below zero value, a fault is detected.

On some ranges the input circuitry may saturate before the fault level set is reached. In this case an error is detected at a level below that which is set.

Control actions and control outputs in the event of a fault are programmable – see below.

Set the value required, between 0.0 and 100.0% in 0.1% increments.

Default Control Action

Select the default control action required in the event of a fault:

- none* – No default action.
- HOLD* – The controller reverts to Manual mode when an error is detected. The control output is held at the value existing when the error was detected.
- O/P* – The controller reverts to Manual mode when an error is detected and the control output value changes to the **Default Control Output** value following.

Default Control Output

Set the default output value required in the event of a fault, between 0.0 and 100.0%.

Programmable Filter

This filters the process variable input, i.e. if the input is stepped, it smooths the transition between steps and may also be used for some degree of cleaning of noisy inputs. The filter time represents the time a step in the input takes to change the displayed process variable from 10 to 90% of the step.

Set value required, between 0 and 60 in 1 second increments.

Mains Filter

Set the frequency of the mains supply being used (50 or 60Hz).

Return to top of **Process Variable Input Page** or advance to next program page.

PRODUCTS & CUSTOMER SUPPORT

Products

Automation Systems

- *for the following industries:*
 - Chemical & Pharmaceutical
 - Food & Beverage
 - Manufacturing
 - Metals and Minerals
 - Oil, Gas & Petrochemical
 - Pulp and Paper

Drives and Motors

- *AC and DC Drives, AC and DC Machines, AC motors to 1kV*
- *Drive systems*
- *Force Measurement*
- *Servo Drives*

Controllers & Recorders

- *Single and Multi-loop Controllers*
- *Circular Chart , Strip Chart and Paperless Recorders*
- *Paperless Recorders*
- *Process Indicators*

Flexible Automation

- *Industrial Robots and Robot Systems*

Flow Measurement

- *Electromagnetic Flowmeters*
- *Mass Flow Meters*
- *Turbine Flowmeters*
- *Flow Elements*

Marine Systems & Turbochargers

- *Electrical Systems*
- *Marine Equipment*
- *Offshore Retrofit and Referbishment*

Process Analytics

- *Process Gas Analysis*
- *Systems Integration*

Transmitters

- *Pressure*
- *Temperature*
- *Level*
- *Interface Modules*

Valves, Actuators and Positioners

- *Control Valves*
- *Actuators*
- *Positioners*

Water, Gas & Industrial Analytics

Instrumentation

- *pH, conductivity, and dissolved oxygen transmitters and sensors*
- *ammonia, nitrate, phosphate, silica, sodium, chloride, fluoride, dissolved oxygen and hydrazine analyzers.*
- *Zirconia oxygen analyzers, katharometers, hydrogen purity and purge-gas monitors, thermal conductivity.*

Customer Support

We provide a comprehensive after sales service via a Worldwide Service Organization. Contact one of the following offices for details on your nearest Service and Repair Centre.

United Kingdom

ABB Limited
Tel: +44 (0)1480 475321
Fax: +44 (0)1480 217948

United States of America

ABB Inc
Tel: +1 215 674 6000
Fax: +1 215 674 7183

Client Warranty

Prior to installation, the equipment referred to in this manual must be stored in a clean, dry environment, in accordance with the Company's published specification.

Periodic checks must be made on the equipment's condition. In the event of a failure under warranty, the following documentation must be provided as substantiation:

1. A listing evidencing process operation and alarm logs at time of failure.
2. Copies of all storage, installation, operating and maintenance records relating to the alleged faulty unit.

ABB has Sales & Customer Support expertise
in over 100 countries worldwide

www.abb.com

The Company's policy is one of continuous product
improvement and the right is reserved to modify the
information contained herein without notice.

Printed in UK (07.05)

© ABB 2005



ABB Limited

Howard Road, St. Neots
Cambridgeshire
PE19 8EU
UK

Tel: +44 (0)1480 475321

Fax: +44 (0)1480 217948

ABB Inc.

125 E. County Line Road
Warminster
PA 18974
USA

Tel: +1 215 674 6000

Fax: +1 215 674 7183