

Module and Application Description

PROCONTROL P

Smart Electric Actuator for PROCONTROL P

Publication No.
D KWL 6328 95 E, Edition 10/99
Replacing D KWL 6328 95 E, Edition 01/98

PROPOS

Contents

| | | | | | |
|----------|--|---|-----------|--|----|
| 1 | Application | 2 | 5 | Basic setting parameters | 7 |
| 2 | Internal sensors and monitoring | 4 | 6 | Service planning | 8 |
| 2.1 | Current measurement | 4 | 7 | Local interventions (optional) | 8 |
| 2.2 | Voltage–zero measurement | 4 | 8 | External interfaces | 8 |
| 2.3 | Phase–sequence monitoring and correction | 4 | 8.1 | Serial interface (optional) | 8 |
| 2.4 | System–frequency monitoring | 4 | 8.2 | PROCONTROL P fieldbus connection | 8 |
| 2.5 | Electronics power supply and monitoring | 4 | 8.3 | Fieldbus address | 8 |
| 2.6 | Power–feed monitoring | 4 | 8.4 | Power–feed connection | 9 |
| 2.7 | Power–factor determination (optional) | 4 | 9 | PROCONTROL P processing section | 9 |
| 2.8 | Fault–current monitoring (optional) | 4 | 9.1 | Processing | 9 |
| 2.9 | Heat–sink temperature monitoring | 4 | 9.2 | Structuring | 9 |
| 2.10 | Motor–temperature detection | 4 | 9.3 | Addressing | 9 |
| 2.11 | Actuating–path detection | 5 | 9.4 | Parameter list (structure) | 10 |
| 2.12 | Torque detection | 5 | 9.5 | Simulation | 10 |
| 2.13 | Direction of rotation of the fitting | 5 | 9.6 | Event generation | 10 |
| 3 | External sensors and monitoring | 5 | 9.7 | Disturbance bit evaluation, receive monitoring | 11 |
| 3.1 | Multi–purpose input (optional) | 5 | 9.8 | Diagnosis and annunciation functions | 11 |
| 3.2 | Combined input for analog measurements 4 up to 20 mA or binary signals (optional) | 5 | 9.9 | Operating states of the module | 13 |
| 4 | Functions and monitoring | 6 | 9.10 | Module cycle time | 13 |
| 4.1 | Thermal overload protection | 6 | 9.11 | Function blocks | 14 |
| 4.2 | Current–limit monitoring and current–limiting analog control (optional) | 6 | 10 | Function diagram | 15 |
| 4.3 | Motor–braking unit | 6 | 11 | Connection diagrams | 16 |
| 4.4 | Soft start–up, soft coasting | 6 | 11.1 | Drive | 16 |
| 4.5 | Motor–stalling protection | 6 | 11.2 | External inputs (optional) | 17 |
| 4.6 | Underload | 7 | 12 | Mechanical design | 18 |
| 4.7 | Load unbalance (optional) | 7 | 13 | Technical data | 19 |
| 4.8 | Motor start–up monitoring | 7 | | | |
| 4.9 | Frequency–of–operation diagnosis | 7 | | | |
| 4.10 | Thyristor test | 7 | | | |



1 Application

The smart electric actuator PROPOS includes:

- Thyristor–power controller
- Switchgear control systems with diagnosis and protective functions
- PROCONTROL P process control equipment for the drive with measuring, protection, analog and binary control functions
- Sensors for motor current and fault current
- Sensors for position, torque and motor temperature
- Mechanical actuator with motor and gear unit.

Via the PROCONTROL P fieldbus the actuator is directly integrated in the power plant control system PROCONTROL P.

The smart electric actuator can be used as a component of the power plant control system. The complete drive control equipment is already included.

All process data of the power plant control system are available for the smart electric actuator for processing operations.

All process data of the smart electric actuator can be made available to the user via the PROCONTROL P power plant control system at any location.

The process control equipment inside the smart electric actuator contains all relevant PROCONTROL P function blocks.

Each smart electric actuator can be

- operated and monitored from a central control room for process operation,
- given parameters from a central diagnosis station. This is also where detailed diagnosis takes place, i. e. also the display of messages resulting from the monitoring of the individual functions.
- structured and loaded from the programming, diagnosis and display system (PDDS) with the required user program, i. e. the logic combinations of the relevant PROCONTROL P function blocks.

It is intended to be used with the process operator station (POS).

It can be used for the following applications (cf. Table 1):

- Control drive incl. logic combinations for the drive control level
- Motor–driven actuator incl. logic combinations for the individual–drive control level.

The appropriate adapter at the drive interface (cf. "Mechanical design") provides the necessary adaptation for the fitting concerned.

The modular design of PROPOS allows to replace individual modules, cf. Operating instructions.

Note:

The default values mentioned for the functions described in the following are those values which are basically preset in the electronic equipment when the parts leave the manufacturing process.

Upon delivery to the user, these values may differ.

Responsibility for correct setting of the parameters for the operation lies with the user.

| Binary – control rotary actuators | | | | Analog – control rotary actuators | | | | |
|---|---|------------------------------------|-------------------------------------|---|---------------------------|---|------------------------------------|-------------------------------------|
| Drive type | Torque range Min./max. setting range | Speed range *) | | Drive type | Max. control torque | Torque range Min./max. setting range | Speed range | |
| | Nm | 1/min | | | Nm | Nm | 1/min | |
| DBM II 30 | 10 – 30 | 5 ... 160 | | DBM II R 30 | 15 | 0 – 30 | 5 ... 40 | |
| DBM II 59 | 20 – 60 | | | DBM II R 59 | 30 | 0 – 60 | | |
| DBM II 60 | 20 – 60 | | | DBM II R 60 | 30 | 0 – 60 | | |
| DBM II 120 | 40 – 120 | | | DBM II R 120 | 60 | 0 – 120 | | |
| DBM II 249 | 80 – 200 | | | 5 ... 80 | DBM II R 250 | 120 | 0 – 250 | |
| DBM II 250 | 80 – 250 | | | 5 ... 160 | DBM II R 500 | 200 | 0 – 500 | |
| DBM II 500 | 150 – 500 | | | | DBM II R 1000 | 500 | 0 – 1000 | |
| DBM II 1000 | 300 – 1000 | | | 5 ... 80 | | | | |
| Binary – control linear – motion actuators | | | | Analog – control linear – motion actuators | | | | |
| Drive type | Thrust – force range Min./max. setting range | Max. travel | Positioning time for max. travel | Drive type | Max. control thrust-force | Thrust – force range Min./max. setting range | Max. travel | Positioning time for max. travel |
| | kN | mm | sec | | kN | kN | mm | sec |
| DLBM II 15 | 5 – 15 | 100 | 9.5 ... 300 | DLBM II R 15 | 8 | 0 – 15 | 100 | 38 ... 300 |
| DLBM II 20 | 10 – 20 | | | DLBM II R 20 | 10 | 0 – 20 | | |
| DLBM II 40 | 15 – 40 | 350 | 22 ... 700 | DLBM II R 40 | 20 | 0 – 40 | 350 | 88 ... 700 |
| DLBM II 80 | 30 – 80 | | | DLBM II R 80 | 40 | 0 – 80 | | |
| Binary – control slewing – motion actuators | | | | Analog – control slewing – motion actuators | | | | |
| Drive type | Torque range Min./max. setting range | Positioning time for 90 degrees | | Drive type | Max. control torque | Torque range Min./max. setting range | Positioning time for 90 degrees | |
| | Nm | sec | | | Nm | Nm | sec | |
| DPBM II 30 | 10 – 30 | 8 ... 60 | | DPBM II R 240 | 120 | 0 – 240 | 12 ... 96 | |
| DPBM II 59 | 20 – 60 | | | DPBM II R 500 | 250 | 0 – 500 | 19 ... 150 | |
| DPBM II 119 | 40 – 120 | | | DPBM II R 1000 | 500 | 0 – 1000 | 28 ... 225 | |
| DPBM II 250 **) | 80 – 250 | | | DPBM II R 2000 | 1000 | 0 – 2000 | 28 ... 225 | |
| DPBM II 319 | 120 – 320 | | | DPBM II R 3000 | 1500 | 0 – 3000 | 28 ... 225 | |
| DPBM II 799 | 320 – 800 | | | | | | | |
| DPBM II 1599 | 800 – 1600 | | | | | | | |
| DPBM II 3200 | 1600 – 3200 | | | | | | | |

*) Drives with 120/160 min⁻¹ are not self-locking.

**) In preparation.

Table 1: Type series of the smart electric actuators PROPOS (standard version)

2 Internal sensors and monitoring

2.1 Current measurement

The motor current is measured in one phase using a compensated current transformer. Due to the torque and temperature monitoring function, a single-phase current measurement is sufficient.

The measuring signal is conditioned electronically.

The motor current can be shown on the diagnosis station in the form of an absolute value and as a percentage value. In this case, 100 % refer to the rated current entered.

The motor current can additionally be applied to the PROCONTROL P system as a percentage value.

By automatic adaptation of the measuring sensitivity, related to the measured value for currents starting from 0.35 A, the measurement uncertainty is < 2 %.

The following parameters are set in the factory (default values in brackets)

- Rated current 0.06 up to 25 A (0 A)
MANDATORY entry
- End of measuring range 100 % 0.06 up to 200 A (rated current)
- Beginning of measuring range 0 % 0.01 up to 200 A (0 A)

2.2 Voltage-zero measurement

The voltage zero of each system phase is scanned as a binary value. The voltage tap is located at the power feed-in. The voltage tap is electrically separated from the signal electronics equipment.

2.3 Phase sequence monitoring and correction

The phase sequence of the applied power-feed is monitored with the help of voltage-zero measurement, and the direction of the rotating field is indicated.

A wrong phase sequence (counter-clockwise rotating field) can automatically be corrected.

The following parameter can be set (default value in brackets)

- Exchange phase sequence on/off (on)

2.4 System-frequency monitoring

The frequency of the applied power feed is monitored with the help of voltage-zero measurement. The monitoring function checks whether an intact three-phase system is in place, i.e. whether the voltage zeros of the three phases are coming in in right order and at intervals that correspond to the system frequency. In case there is any failure or fault detected, a message will be issued.

2.5 Electronics power supply and monitoring

The voltage for the electronics equipment is formed from the power-feed. Without power-feed, the drive cannot be operated.

In the case of a failure of the electronics power supply, the drive is disconnected. The disturbance is detected by the field-bus coupling module and is indicated. The message is delayed by the amount of time necessary for a possible switchgear changeover (≤ 5 sec).

2.6 Power-feed monitoring

Phase 1 is monitored by the current measurement or the voltage-zero measurement function. The power-feed of phases 2 and 3 are monitored using the electronics voltage. As soon as one phase fails, the drive is disconnected and a fault signal is put out. In order to avoid unnecessary signalling in the case of a temporary busbar disturbance, the message is delayed if the monitoring function responds while the drive is in disconnected condition.

2.7 Power factor determination (optional)

The power factor is calculated from the current measurement and the voltage-zero measurement.

The measurement uncertainty at $\cos \varphi = 0.5$ is ± 5 %.

2.8 Fault-current monitoring (optional)

Fault currents are measured directly behind the power-feed connector with a summation current transformer. This transformer is connected in front of the thyristors.

The following parameters can be set (default values in brackets)

- Fault-current tripping yes/no (no)
- Tripping in the case of fault-current sensor fault yes/no (no)
- Signalling limit 0.05 up to 2.5 A (0.05 A)
- Tripping limit 0.05 up to 2.5 A (0.1 A)
- Fault-current sensor present yes/no (no)

Arrival at the signalling limit is indicated.

Arrival at the tripping limit is indicated and, if the parameter has been set appropriately, the motor is disconnected.

During the motor start-up time, the messages are suppressed.

The fault-current sensor is checked cyclically via an auxiliary winding. When the monitoring function responds, a message is formed and, if the parameter has been set appropriately, the motor is disconnected.

2.9 Heat-sink temperature monitoring

The temperature of the heat sink is monitored by means of NTC sensors.

In the event of a violation of the limit value of 84 °C, the motor is disconnected and a fault signal is put out.

2.10 Motor temperature detection

The temperature in the motor winding is detected by means of three PTC sensors connected in series in the motor winding. As soon as the temperature-limit value responds, the motor is disconnected and a fault signal is put out.

2.11 Actuating path detection

The actuating path is scanned in the form of an analog value.

The setting of actuating path and parameters is done automatically during automatic commissioning. It is designed so that limit switches which have to be set mechanically are not needed. The position will be scanned continuously over its entire range.

If automatic commissioning is not possible due to a missing torque-dependent disconnection towards CLOSED, manual commissioning has to be performed using the local diagnosis station.

2.12 Torque detection

In the case of the smart electric actuator PROPOS, the torque switches are not needed.

The torque is scanned as an analog value with sign.

For setting the tripping torques in end and intermediate positions, the valves and fittings data on the electronics nameplate are used. In case these data are not provided, the tripping values can also be set at the diagnosis station with the following parameters

| | |
|---|---------------------------|
| – Tripping torque operation End position CLOSED | 0 up to 100 % |
| – Tripping torque operation End position OPEN | 0 up to 100 % |
| – Type of tripping of the fitting for operation OPEN or CLOSED | End position or torque |
| – Start torque for automatic commissioning Direction of rotation CLOSED | 0 up to 100 % |
| – Start torque for automatic commissioning Direction of rotation OPEN | 0 up to 100 % |
| – Travel | |
| – Type of tripping of the fitting for commissioning OPEN or CLOSED | End position or torque |

In this case, 100 % refer to the rated torque of the smart electric actuator PROPOS and, thus, to the maximum tripping torque that can be selected. The settings depend on the type of actuator. For the setting values, please refer to 'Torque range' in Table 1.

A message is issued for any torque-related trip in the intermediate position.

Based on torque and actuating path, torque trends in relation to the actuating path are stored for both directions of rotation:

- Setpoint trend, factory
- Setpoint trend, cold plant
- Setpoint trend, warm plant
- Actual trend (run through last)

By an entry at the diagnosis station it is possible to store operating variables and date of scanning as additional information.

The torque trends can be called up from the diagnosis station and can be compared and diagnosed.

Up to 10 trend curves can be filed in an archive on the diagnosis station.

A violation of the tolerance band of the trend used last will be indicated in comparison with a defined reference trend.

2.13 Direction of rotation of the fitting

For the CLOSED direction of the fitting, it is possible to define whether the direction shall be clockwise or anti-clockwise.

The following parameter can be set (default value in brackets)

- CLOSED direction of rotation clockwise/anti-clockwise
(clockwise)

Attention:

The direction of rotation of the fitting may only be changed in the course of a recommissioning procedure.

3 External sensors and monitoring

3.1 Multi-purpose input (optional)

The standard multi-purpose input is connected to a PT100 temperature sensor scanning the temperature of the electronics equipment.

The following parameters can be set (default values in brackets)

- | | | |
|---------------------------|-----------------|---------|
| – Temperature measurement | yes/no | (yes) |
| – Signalling limit | 70 up to 150 °C | (70 °C) |
| – Tripping limit | 70 up to 150 °C | (85 °C) |

Arrival at the signalling limit will be indicated.

When the tripping limit has been reached, the motor is disconnected and a signal is put out.

The temperature of the electronics equipment can be displayed on the diagnosis station.

By reconnecting the internal jumpers, an external sensor can be connected if no measurement of the electronics temperature is required.

The configuration of the multi-purpose input is then performed by PROCONTROL P function block EP06.

At the multi-purpose input, the following types of external sensors can be connected:

- PT100 thermal resistor, four-wire type (for 150 °C)
- PTC-thermistor detector (thermistor) to DIN 44080 or IEC 34-11-2
- Contact input without monitoring
- 4 up to 20 mA transducer (2-wire)
- 4 up to 20 mA transducer (4-wire)

3.2 Combined input for analog measurements 4 up to 20 mA or binary signals (optional)

Two combined inputs are available.

These inputs can be configured either as binary inputs for 24 V or as analog inputs for 4 up to 20 mA.

The configuration of this process interface is carried out with the help of PROCONTROL P function block EP06.

4 Functions and monitoring

4.1 Thermal overload protection

A cyclic calculation determines, whether a thermal overload of the drive is present. For this purpose, a calculation model is used based on the current/time characteristic of a bimetal tripping device. The rated current of the motor is used as a reference variable.

The following parameters can be set (default values in brackets)

| | | |
|--|------------------|-----------|
| – Overload trip | on/off | (on) |
| – Thermal memory | on/off | (on) |
| – T6 tripping class according to DIN VDE 660, part 102 and 105 | 5 up to 40 | (10) |
| – Reclosing lockout time | 0 up to 9990 sec | (100 sec) |
| – Thermal protection with power factor | yes/no | (no) |

Tripping class

As input variable for the temperature–increase calculation, the r.m.s. value of the measured current is used. The thermal character of the motor is determined by the set T6 tripping class.

Overload trip

It is possible to choose whether the motor is to be disconnected in the case of a calculated overload. If an overload is present, a fault signal is put out. Tripping upon thermal overload must be acknowledged at the diagnosis station.

Thermal memory

The calculated motor temperature increase is filed in a non-volatile memory (thermal memory) in case the supply of the electronics system is interrupted (e.g. due to failure of the power–feed). After the supply voltage is restored, this thermal value applies provided the parameter has been set accordingly. Resetting of the parameter simultaneously erases the thermal memory.

4.2 Current limit monitoring and current–limiting analog control (optional)

The motor current is monitored for the max. admissible limits, i.e. during the motor start–up time for motor current limit *Start–up* and after the motor start–up time for motor current limit *Operation*.

A violation of the limit values is indicated.

If the parameter for *Current–limitation control* 'ON' is set, the set motor–current limits are not violated due to current–limitation control.

The following parameters for the motor current limit can be set (default values in brackets)

| | | |
|------------------------------|-------------|---------|
| – Start–up | 100 – 800 % | (730 %) |
| – Operation | 100 – 800 % | (450 %) |
| – Current–limitation control | on/off | (off) |

In this case, 100 % refer to the rated current set.

4.3 Motor braking unit

The motor can be decelerated according to the d.c. braking principle.

Note: Not suitable for binary–control actuators.

After the braking function is selected, the motor is disconnected and a d.c.–voltage generated by the electronics equipment is applied to two terminals at the motor winding. The braking force is set by the phase control function.

If after the set braking time another system period has passed, the braking procedure is completed. After that, a restart is possible.

The following parameters can be set (default values in brackets)

| | | |
|--|---------------|----------|
| – Braking function | on/off | (off) |
| – Braking force, clockwise rotation | 35 – 50 % | (50 %) |
| – Braking force, anti–clockwise rotation | 35 – 50 % | (50 %) |
| – Braking time for clockwise rotation | 0.01 – 30 sec | (10 sec) |
| – Braking time for anti–clockwise rotation | 0.01 – 30 sec | (10 sec) |

4.4 Soft start–up, soft coasting

For smooth operation, the motor voltage can be varied in the form of a nearly linear ramp with an adjustable ramp offset.

The ramp times for start–up and coasting can be varied separately.

The following parameters can be set (default values in brackets)

| | | |
|-----------------------|------------------|---------|
| – Soft start–up | yes/no | (no) |
| – Soft coasting | yes/no | (no) |
| – Ramp offset | 35 up to 100 % | (35 %) |
| – Ramp time, start–up | 0.01 up to 1 sec | (1 sec) |
| – Ramp time, coasting | 0.01 up to 1 sec | (1 sec) |

For disconnection, the smooth–coasting function is not activated in the following cases:

- Disconnection via the PROPOS protection equipment
- Braking function active
- Torque or end position active.

4.5 Motor–stalling protection

In parallel with the thermal overload protection, the motor–stalling protection function is on. If the set stalling current limit is exceeded, the stalling time is started. As soon as the value falls below the stalling current limit again, the time is reset. If the motor current stays above the limit during the entire stalling time, a fault signal is put out and the motor is disconnected.

The motor–stalling protection is suppressed during the motor start–up time.

The following parameters can be set (default values in brackets)

| | | |
|-----------------------------|-----------------|----------|
| – Motor–stalling protection | on/off | (off) |
| – Stalling current limit | 120 up to 800 % | (730 %) |
| – Stalling time | 1 up to 50 sec | (10 sec) |

In this case, 100 % refer to the set rated current.

4.6 Underload

If the torque detected by the sensors falls below adjustable limit values, a signal will be put out.

The underload limit torque cannot be set to a lower value than the no-load limit torque.

The following parameters can be set (default values in brackets)

- Underload check on/off (off)
- No-load torque 0 up to 100 % (0 %)
- Underload limit torque 0 up to 100 % (0 %)

4.7 Load unbalance (optional)

It is monitored whether one of the three-phase currents deviates from the two others by more than the set percentage of the rated current.

Load unbalance monitoring is performed during standstill.

The following parameters can be set (default values in brackets)

- Disconnection on/off (on)
- Signalling limit 0 up to 100 % (10 %)
- Tripping limit 0 up to 100 % (20 %)

Arrival at the signalling limit is indicated.

A signal is put out when the tripping limit is reached and provided that the respective parameter has been set accordingly, a reconnection of the motor will be prevented.

The load-unbalance monitoring is suppressed during start-up time.

A load-unbalance trip must be acknowledged on the diagnosis station.

4.8 Motor start-up monitoring

During motor start-up it is monitored, whether the start-up takes place within the specified start-up time. The parameter can be adjusted separately for both directions of rotation.

Until the start-up time is completed, the following disturbance signals are suppressed:

- Fault-current signal
- Stalling signal
- Load-unbalance signal

If the motor is not started up within the specified start-up time, a signal will be put out. A motor start-up is considered to be completed, when the motor current is automatically adjusted below the admissible continuous current limit ($1.05 \times I_n$) within the set start-up time.

The following parameters can be set for the motor start-up time (default values in brackets)

- Clockwise rotation 0.1 up to 100 sec (10 sec)
- Anti-clockwise rotation 0.1 up to 100 sec (10 sec)

4.9 Frequency-of-operation diagnosis

The frequency-of-operation diagnosis is used to monitor whether a certain number of switching actions is exceeded within a certain time interval.

In case a limit value is violated, a corresponding indication will be given and a signal will be put out to be annunciated in PRO-CONTROL P, provided the operating frequency monitoring has been activated.

The following parameters can be set (default values in brackets)

- Frequency-of-operation monitoring on/off (off)
- Maximum frequency of operation 0 up to 65535 (1200)
- Time interval for maximum frequency-of-operation 0 up to 180 min (60 min)

4.10 Thyristor test

Thanks to five thyristor modules, it is possible to switch the motor even in case one thyristor module has failed.

Cyclic tests are performed in order to check the switching ability of the thyristor modules under load. The tests are carried out while the motor is at a standstill.

During the initialization phase, e.g. when the electronics equipment connects power, these tests are generally run.

The thyristor test can be switched off.

The following parameter can be set (default value in brackets)

- Thyristor test on/off (on)

5 Basic setting parameters

In addition to the rated current (cf. "Current measurement"), the following basic setting parameter need to be set (default value in brackets):

- Module version PROPOS (0) *)
MANDATORY entry

*) 0 means: no parameters set

In case a MANDATORY parameter is missing, all switching actions are inhibited for the module.

In addition, the following basic setting parameter is to be specified (default value in brackets):

- System frequency 50/60 Hz (50 Hz)

6 Service planning

On account of the evaluation of drive-specific data (design data), a status-oriented service is possible over the diagnosis station.

The following parameters can be set (default values in brackets)

- Specification of the operating cycles 1 up to $16 \cdot 10^6$ (100.000)
- Service interval, operating cycles 1 up to $16 \cdot 10^6$ (10.000)

For this purpose, the following current service data are recorded inside the drive:

- Current number of operating cycles
- Number of operating cycles since last service *)
- Number of operating cycles during last hour
- Total number of torque trips
- Number of torque trips since last service *)

Furthermore, also time-based service planning is possible.

The following parameters can be set (default values in brackets)

- Specification of operating hours 1 up to $16 \cdot 10^6$ hrs (10.000 hrs)
- Service interval Operating hours 1 up to $16 \cdot 10^6$ hrs (1.000 hrs)
- Service interval
- Next service date
- Start date, fitting
- Start date, drive
- Start date, electronics equipment
- Last service date

For this purpose, the following current service data are recorded inside the drive:

- Total number of operating hours
- Operating hours since last service *)

Violation of adjustable limits will be indicated.

*) After the service activity is completed, these data can be set to zero from the diagnosis station.

Furthermore, it is possible to file data on fittings, drives and gearings (electronic rating plate) on the smart PROPOS actuator and in the data base of the diagnosis station.

7 Local interventions (optional)

Aside from parameter setting and displaying information via the central diagnosis station, also local interventions are possible.

These local interventions are possible only if a local diagnosis station is connected via a serial interface (optional).

They are generally protected by passwords and are given priority over interventions coming from the fieldbus (control room, group control level or central diagnosis station).

Each intervention with the local diagnosis station is indicated over the bus in the PROCONTROL P system.

Two types of local operations can be performed:

Local parameter setting

After logging-on for parameter setting, switching commands, process signals and parameter changes coming from the fieldbus are ignored and message *Intervention for local parameter setting active* is set.

The acknowledgement of the message is possible only via the central diagnosis station.

Local operation

Upon logging-on for local operation, switching commands, process signals and parameter changes coming from the fieldbus are ignored and message *Intervention for local operation active* is set.

Further local operations can be carried out with the handwheel and the optional operating and display terminal (BAT). Both actions are indicated on the diagnosis station and are signalled in the PROCONTROL P system. If an intervention via the handwheel is not admissible, it shall be locked mechanically.

8 Further external interfaces

8.1 Serial interface (optional)

A local diagnosis station can be connected to a serial interface.

8.2 PROCONTROL P fieldbus connection

The smart electric actuator PROPOS can communicate via the fieldbus with the PROCONTROL P system either using one channel or two channels (redundant).

The telegrams received over the bus are checked by the module on the basis of their parity bits for error-free transmission.

The telegrams sent from the module to the bus are provided with parity bits. Thus, error-free transmission is ensured.

The user program is filed on a nonvolatile memory (Flash-PROM). Loading and changing of the user program is performed from the programming, diagnosis and display system (PDDS) over the bus.

The module is ready for operation if the power-feed is connected, the fieldbus address is set and a valid user program is loaded.

8.3 Fieldbus address

The address of the drive at the fieldbus is set via terminals on the compact-type connector of the drive. The address will be assigned according to the place of installation. This way, if a drive needs to be replaced it is ensured that the drive will receive the right process information.

Addresses 1 ... 63 can be set. Addresses 0 and 64 are reserved for the respective coupling modules and cannot be used by the modules.

8.4 Power–feed connection

The smart electric actuator receives its power supply via the compact–type connector from a fused outgoing circuit. A switchgear (with power controller) is not necessary.

In addition to the power feed–in provided, no further power supply is needed. In the internal power supply unit, the required electronics voltages are formed.

The drive is maintenance–free. Local signalling is not necessary.

9 PROCONTROL P processing section

9.1 Processing

For processing the internal control signals, the external sensor signals and the signals coming from the bus, the smart electric actuator is equipped with a 32–bit microprocessor which cooperates with the following memory areas via a special bus inside the module:

| Contents | Storage medium |
|---|----------------|
| Operating program | Flash–PROM |
| Function blocks | Flash–PROM |
| User program (structure, address and simulation list) | Flash–PROM |
| History values | RAM |
| Current module input and output signals (shared memory) | RAM |

The operating program allows the microprocessor to perform the elementary operations of the module.

The memory for the function blocks contains standard programs for the implementation of the various functions.

All function blocks with their inputs and outputs can be called up by the user via the programming, diagnosis and display system (PDDS).

The memory for the user program contains information on:

- how the function blocks are interconnected,
- which module inputs and outputs are assigned to which inputs and outputs of the function blocks,
- which fixed values are specified for the individual inputs of the function blocks,
- which parameters are specified for the individual inputs of the function blocks,
- which plant signals are assigned to which module inputs and outputs,
- which function blocks support the process interfaces,
- which function results, module input and output signals are simulated.

This information is defined by the user depending on the plant conditions.

The complete user program is filed in a Flash–PROM.

Setting values can be specified by the user directly at the respective function–block inputs in the form of a value (fixed value) or as parameters.

Fixed values and parameters can be changed on–line any–time. In that case, they are changed and stored in the Flash–PROM.

Via the memory for the module input and output signals, the exchange of information between module and bus system takes place. It is used for buffering the signals.

At function block 'Input of analog and binary process signals EP06', all internal and external sensor signals for PROCONTROL P can be activated.

Command output at the power section is effected by function block 'Output of binary process signals AP06'.

9.2 Structuring

During structuring, the neutral inputs and outputs of the individual function blocks are assigned certain logic combinations. Inputs at the function blocks can be given a module input, an output of another function block on the module (function result) or fixed values and parameters. Outputs of function blocks can be logically combined with module outputs and function blocks on the module.

Structuring must be oriented to the following limit values of the module:

- Max. number of module inputs 128
- Max. number of simulatable signals 32
- Max. number of module outputs 64
- Max. number of simulatable module outputs 32
- Max. number of function results 255
- Max. number of timers 32
- Max. number of (structure) parameters 32
- Max. number of lines in structure list 1024
- Length of history value list (bytes) 512
- Dimensioning of the shared memory (cf. "Addressing")

In this case, one line refers to an entry on the PDDS.

The exact procedure for structuring the function blocks is explained in the respective function block descriptions.

9.3 Addressing

General

The signal exchange between module and PROCONTROL bus system via the fieldbus or the respective coupling module takes place in a shared memory. In this shared memory, the arriving signals that are to be received by the module and the function results that are to leave the module are buffered.

For this purpose, the shared memory uses send registers for the telegrams to be sent and receive registers for the telegrams to be received.

Number of receive registers 16 (a maximum of 32)
 Number of send registers 6 (a maximum of 16)

In this case, the following limit values for a fieldbus are to be taken into consideration:

Receive telegrams a maximum of 1023
 Send telegrams a maximum of 400

The entries of the user are made in the form of address lists.

The allocation of the module input and output signals to the registers of the shared memory is defined by user entries on the PDDS.

Address list for module inputs

In the address list for module inputs, each module input is assigned a PROCONTROL send–location address or a process interface of the signal to be received.

The address list for inputs is translated by the PDDS into two internal lists, i.e. the "bus–address list" and the "allocation list of module inputs".

The 'bus–address list' remains in the coupling module of the respective fieldbus. Each module will receive all receive registers configured for the fieldbus. The 'allocation list of module inputs' of the module defines the selection of receive registers.

In the case of module inputs that receive their signal over the bus, addressing is done by allocating the send–location address to EGn, e.g.:

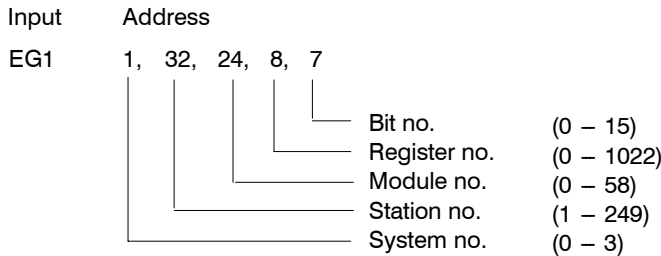

In the case of module inputs that receive their signal from the process operator station (POS), addressing is done by allocating L to EGn, e.g.:

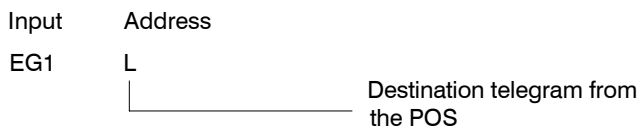

Address list for module outputs to the bus

In the address list for module outputs, for each signal which is to leave the module a send register is defined and, in the case of binary signals, additionally a send bit, e.g.:

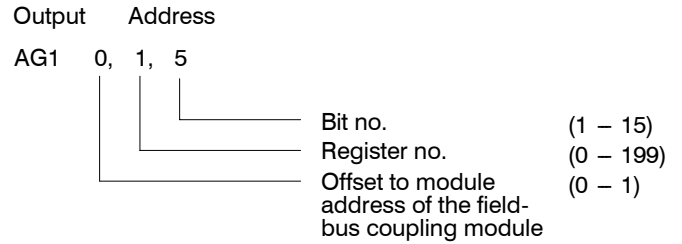

Since the fieldbus coupling module uses two module addresses (n and n+1) at the PROCONTROL station bus, the offset to the module address defines under which address the register will be transferred on the PROCONTROL bus. If the offset = 0, transmission will be with module address n, in the case of offset = 1, with module address n+1.

For the formation of the complete PROCONTROL address, the system, station and module addresses are determined by the slot of the fieldbus coupling module.

9.4 Parameter list (structure)

The parameter list contains up to 32 parameters for function blocks. Parameter values can be changed on–line on the PDDS anytime.

9.5 Simulation

Via the PDDS, a maximum of 32 module signals (function results, module inputs and outputs) can be overwritten with constant values ("simulated"). Simulation values can be changed on–line on the PDDS anytime. In case a simulation is cancelled via the PDDS, a simulation data record is erased and the module will continue to operate with the data received from the bus or with the values formed inside the module.

9.6 Event generation

Every 50 msec the fieldbus coupling module reads the events from the fieldbus modules and sends the new values to the PROCONTROL bus for each event.

The module recognizes the following conditions as an event:

- Change of a binary value
- Change of an analog value by a fixed threshold of 0.39 % and expiration of a time–out of 200 msec since the last transmission (cyclic or per event).

9.7 Disturbance bit evaluation, receive monitoring

The telegrams received over the bus can be provided with a fault flag on bit position 0. This fault flag is generated by the sending module based on plausibility checks and is set to "1" if certain disturbances are present (cf. the respective Module or function block descriptions).

In order to be able to detect faults in signal transmission, the module also uses a monitoring function to check cyclic renewal of the input telegrams. If a signal has not been renewed for a certain amount of time (e.g. due to a failure of the sending module), in the assigned receive register of the shared memory, the bit of position 0 is set to "1". At the same time, in the case of binary value telegrams all binary values are set to "0". With analog values, the old value is maintained.

A set disturbance bit does not automatically cause a reaction in the module. If the disturbance bit of a telegram is to be evaluated, this must be taken into consideration in the structuring process.

Disturbance bits from telegrams received can be used inside the module only. They are not included in telegrams to be sent.

Further information on disturbance bit evaluation is given in the respective function block descriptions.

9.8 Diagnosis and annunciation functions

In the processing section of the module the received telegrams and the formation of the telegrams to be sent as well as the internal signal processing functions are monitored for fault-free condition. Furthermore, self diagnosis operations are performed.

In the event of a disturbance, the fault type is filed in the diagnosis register.

The contents of the diagnosis register is shown in Figure 1.

The fieldbus coupling module reads the diagnosis register cyclically and forwards these messages to the PROCONTROL system.

If necessary, a more detailed diagnosis of individual functions can be carried out with the help of the diagnosis station.

The messages that are available are listed in table 2. Meaning of abbreviations:

- STA Message goes to input STA of the function block concerned.
- TS Message goes to input TS (or VO) of the function block concerned.
- VST Message goes to bit 13 in the diagnosis register of the module.
- PST Message goes to bit 14 in the diagnosis register of the module.

| Message *) | STA | TS | VST | PST |
|---|-----|----|-----|-----|
| Thyristor connection fault | X | | | |
| Thyristor disconnection fault | X | | | |
| Motor start-up time >max. | | | | |
| Fault-current sensor disturbed | X | | | |
| Fault current high | | | | |
| Fault current >max. | X | | | |
| Phase L1 PROPOS >5 sec faulty | X | | | |
| System fault | | | | |
| Motor unbalance thyristor high | | | | |
| Motor unbalance thyristor >max. | X | | | |
| Motor load <min. | | | | |
| Motor load low | | | | |
| Motor current high | | | | |
| Thermal overload >max. | X | | | |
| Motor blocking >max. | X | | | |
| Heat sink temperature >max. | X | | | |
| Motor temperature >max. | X | | | |
| Electronics temperature high | | | | |
| Electronics temperature >max. | X | | | |
| Configuration data missing | X | | X | |
| Module parameters faulty | X | | X | |
| Module address fault | | | | |
| Intervention for local operation active | | X | | |
| Intervention for local parameter setting active | | X | | |
| Intervent. for central operation active | | X | | |
| Intervention for central parameter setting active | | X | | |
| Intervent. for local handwheel active | | X | | |
| Intervention for local BAT active | | X | | |
| Sensor software fault | X | | X | |
| Sensor control voltage fault | X | | | |
| Sensor firmware fault | X | | | |
| Sensor memory fault | X | | | |
| Displacement sensor fault | X | | | X |
| Torque sensor fault | X | | | X |
| Commissioning "OK" missing | X | | | |
| Commissioning fault | | | | |
| Commissioning "stroke" high | | | | |
| Commissioning "stroke" low | | | | |
| Commissioning trend fault | | | | |
| End position disconnection wrong | X | | X | |
| Torque discrepancy high | | | | |
| Torque trip in intermediate position activated | | | | |
| Operating frequency >max. | | | | |
| Operating cycles high | | | | |
| Operating hours high | | | | |
| End position wear-out, open | | | | |
| End position wear-out, closed | | | | |

*) The allocations of STA, TS, VST, and PST can be defined differently based on the system specifics.

Table 2: Messages available on the diagnosis station

Diagnosis
register 246

| Bit | Type | |
|-----|------|-----------------------------------|
| 15 | S | — Parameter fault *) |
| 14 | S | — Process channel fault *) |
| 13 | S | — Processing fault *) |
| 12 | S | — Checksum error detected *) |
| 11 | 0 | |
| 10 | 0 | |
| 9 | 0 | |
| 8 | 0 | |
| 7 | 0 | |
| 6 | 0 | |
| 5 | 0 | |
| 4 | S | — Receive monitoring responded *) |
| 3 | S | — Bus coupling module disturbed |
| 2 | S | — Event mode fault *) |
| 1 | 0 | |
| 0 | 0 | |

*) These messages are included as general messages of all field-bus participants in the diagnosis register of the field-bus coupling module and are indicated there via signal lamp ST.

S = Static annunciations disappear automatically upon deactivation
0 = Not used

Figure 1: PROPOS diagnosis messages

9.9 Operating states of the module

Initialization and bootstrapping with user lists

The initialization is effected upon connection of the operating voltage.

By initialization, the module is put into a defined initial state.

There is no user program available when the module is first started. The module signals "Processing fault".

First, the user program of the PDDS has to be transmitted via bus into the RAM of the module. The PDDS checks the addresses for each transmission in order to avoid wrong lists. The module checks each list received for plausibility.

Now, the complete user program is transferred from the module into the Flash-PROM.

After this procedure is completed, the module is ready for operation.

Normal operation

The module works with the user program filed in the Flash-PROM.

During normal operation, the signals coming from the bus and the internal sensors are processed according to the entries made in the structure list.

Based on these conditions, commands are put out to the internal sensors, and the checkback signals indicating the process status are sent over the bus.

Changing the user program

(structure, address, parameter and simulation list)

User programs (structure, address, parameter and simulation list) can be transferred from the module into the PDDS or can be taken from the data base. Changed user programs can be transferred back to the module. This may be done as described below:

- The changed user program is transferred by the PDDS into the RAM of the module.
- The module checks each received list for plausibility. Then, the new lists are activated and transferred into the non-volatile Flash-PROM.

Changing fixed values

Some fixed values in the structure list can be changed on-line via the PDDS. The changes made are stored in the Flash-PROM.

Changing (structure) parameters

Some parameters in the parameter list can be changed on-line via the PDDS. The changes made are stored in the Flash-PROM.

Simulation

Via the PDDS, module signals can be specified and deleted. The simulation data is stored in the Flash-PROM.

9.10 Module cycle time

A user program is run through with a fixed cycle time. The cycle time is defined in function block TXT2 at the beginning of the structure list. The module cycle time results from number and type of the function blocks listed in the structure list. The fixed cycle time in function block TXT2 is a time minimum. It applies if the time resulting from the processing of the structure list is shorter. The actual cycle time is filed in register 205 and can be read from the PDDS. In case the cycle time in register 205 exceeds the fixed module cycle time in the TXT2 function block, that time needs to be increased.

In order to achieve a more precise positioning in the case of single-variable step controllers, the positioning time of the actuators (of 0–100 %) must be at least 200 times the module cycle time, e.g. positioning time >10 sec at a cycle time of 50 msec.

In order to avoid major time errors in function blocks with time-value inputs, for time values of less than 10 sec only integer multiples of the module cycle time should be used.

9.11 Function blocks

| Function block | Type abbreviation | Function block | Type abbreviation |
|---|--------------------------|--|--------------------------|
| BINARY FUNCTIONS | | ANALOG FUNCTIONS | |
| Switch-off delay element | ASV | Absolute value generator | ABS |
| 2-out-of-3 selection, binary | B23 | Limiter | BEG |
| 2-out-of-4 selection, binary | B24 | Divider | DIV |
| M-out-of-N selection | BMN | Function generator | FKG |
| Bit marshalling | BRA2 | Integrator | INT1 |
| Dual-BCD-converter | DBC1 | Factor variation | KVA |
| Dual-decimal-converter | DDC | Maximum value selector | MAX |
| Dynamic OR element | DOD | Minimum value selector | MIN |
| Switch-on delay element | ESV | Multiplier | MUL |
| Monostable flipflop break | MOA | Monitoring and selecting function | MVN |
| Monostable flipflop constant | MOK | Differentiator | PDT |
| OR element | ODR | Dead-time element | PT0 |
| RS flipflop | RSR | Delay element | PT1 |
| AND element | UND | Square-root extractor | RAD |
| Counter | ZAE | Summing multiplier | SMU |
| | | Time variation | TVA |
| | | Change-over switch | UMS |
| DRIVE CONTROL | | ANALOG CONTROL | |
| Drive control function, unidirectional drive | ASE1 | Manual station | HST1 |
| Drive control function, incremental output | ASI2 | P controller | PRE |
| Drive control function, actuator | ASS1 | PI controller | PIR3 |
| | | PID controller | PID3 |
| LIMIT-SIGNAL ELEMENTS | | | |
| Limit signal for upper limit value | GOG | Differentiator with derivative-action time | PTV |
| Limit signal for lower limit value | GUG | Setpoint integrator | SWI1 |
| Limit signal generation | GRE1 | Setpoint adjuster | SWV1 |
| | | Disturbance bit suppression | SZU |
| PUSHBUTTON SELECTION FUNCTIONS | | PROCESS INPUT AND OUTPUT FUNCTIONS | |
| Pushbutton selection | TAW | Input, process signals | EP06 |
| Pushbutton selection with target value presetting | TAZ | Output, process | AP06 |
| ORGANIZATION FUNCTIONS | | | |
| Text module | TXT | The exact specification of the function blocks as well as the procedure of structuring is explained in the respective function block descriptions. | |
| Text module with cycle time input | TXT2 | | |

10 Function diagram

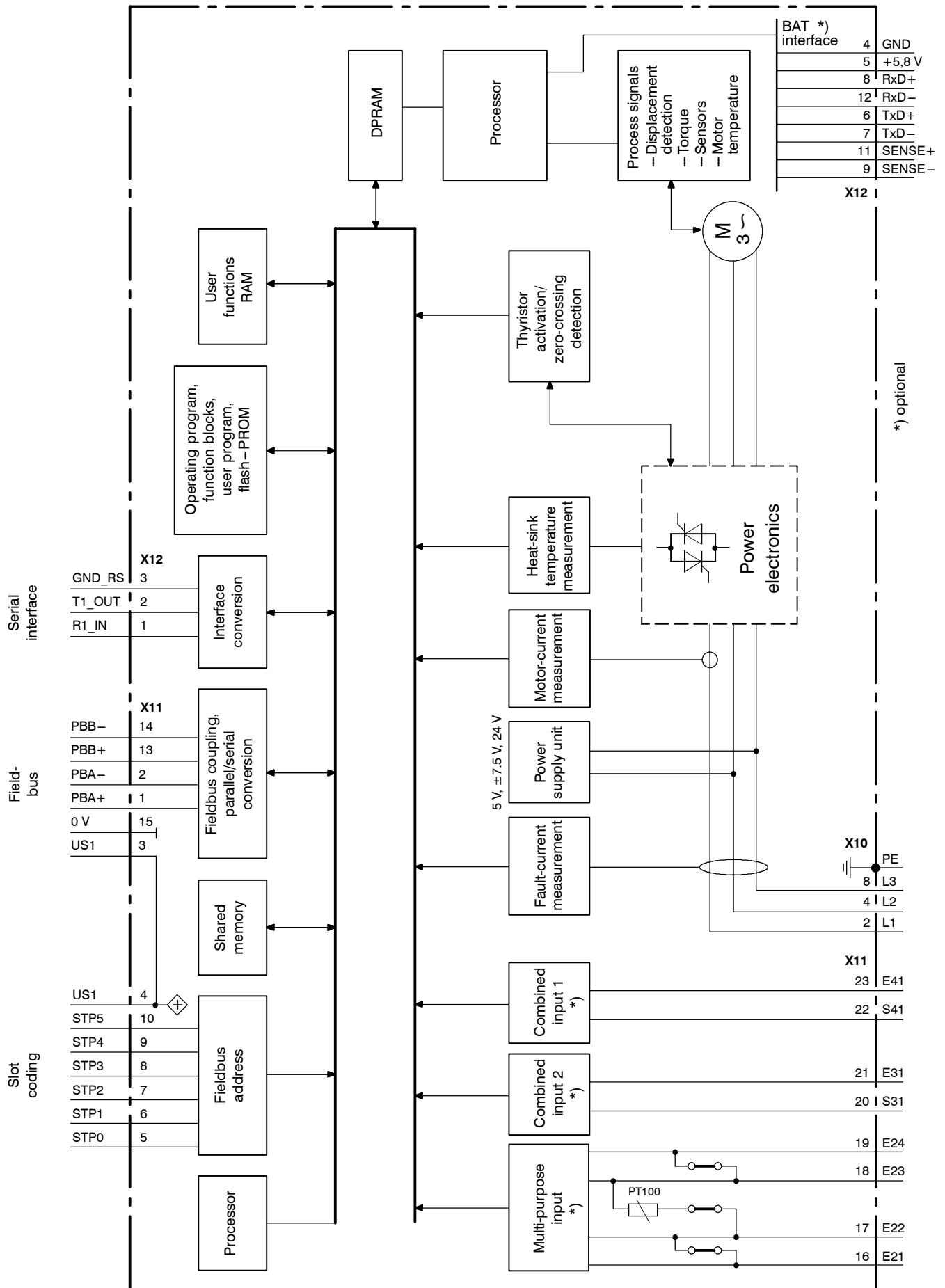

*) optional

11 Connection diagrams

11.1 Connection diagram for drive

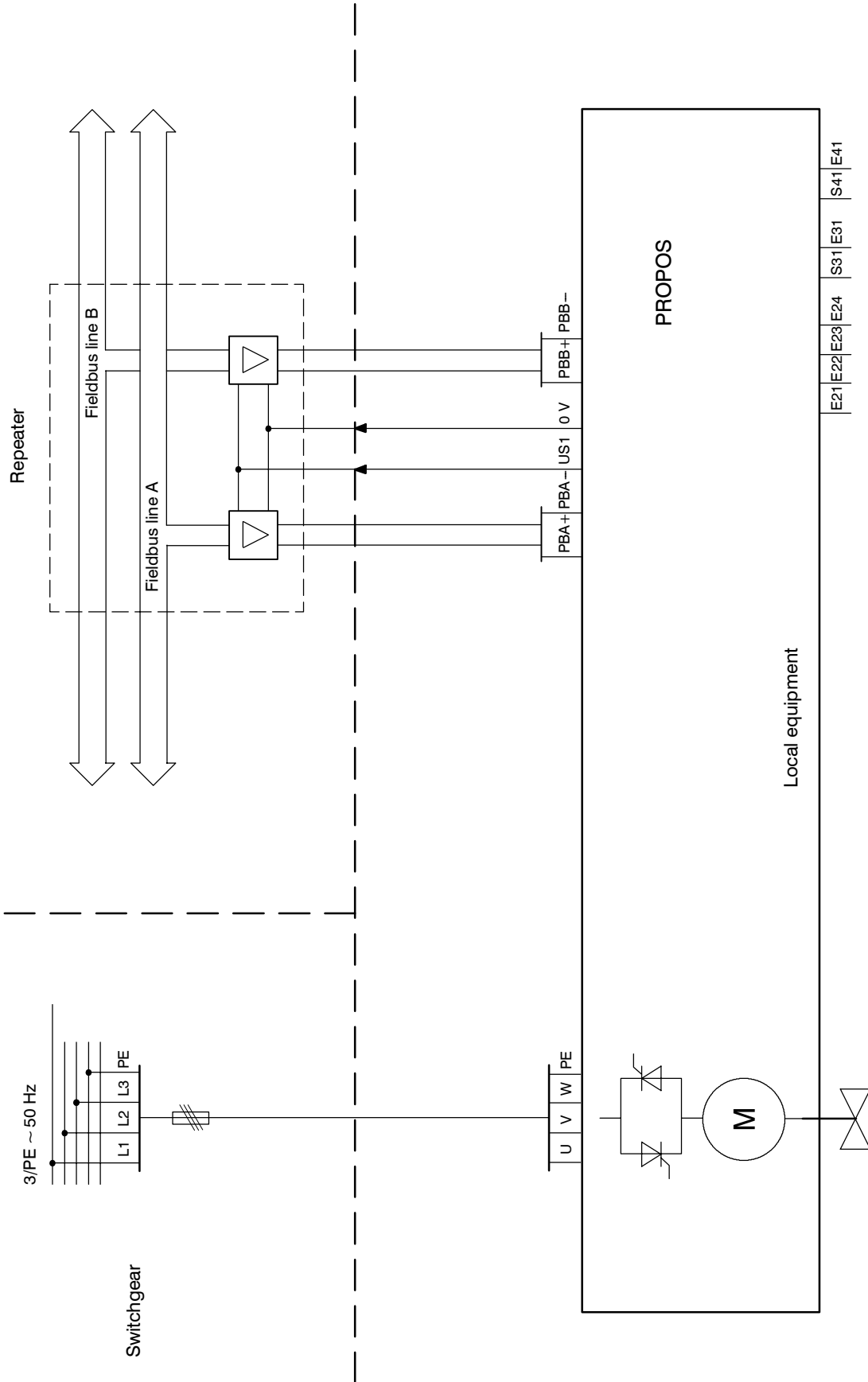

11.2 Connection diagrams for external inputs (optional)

Multi-purpose input

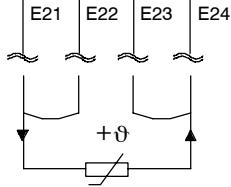
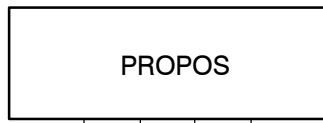

PT100 thermal resistor

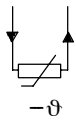

PTC thermistor detector



Contact input

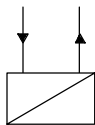

4 up to 20 mA transducer (2-wire)

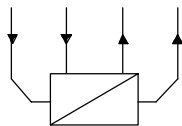

4 up to 20 mA transducer (4-wire)

Combined input 1 or 2

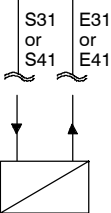
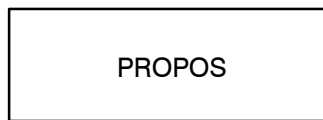

4 up to 20 mA



Binary input

12 Mechanical design

Only a few basic versions of the modular smart PROPOS actuator are necessary to provide either a motor-driven actuator or a regular actuator.

By combining the basic versions with a canned motor, a first speed stage, a second speed stage and a standard mechanical interface at the output side, an actuator version required for a specific application is created.

The necessary drive speed is obtained by selecting speed stage combinations and motor pole number. At the mechanical interface of the drive, outputs suitable for the respective valves and fittings are mounted in accordance with the international standards. This allows simple adaptation to all fittings, as well as subsequent easy modifications without interventions in the main gearing being necessary. The subdivision of the gearing into two speed stages results in high start-up dynamics. Special material combinations having vibration-damping properties minimize noise generation.

Hysteresis-minimized torque scanning of the mechanical parts and low wear and tear as well as low clearance of the circuitry for bringing out the travel signal are special technical features. Ruggedized three-phase induction motors of a high protection class (IP 67) and handwheel emergency actuation without changeover offer a high degree of availability even under rough operating conditions.

Intelligent gearing concept

The well-proven DREHMO-Longlife gearing concept offers a high degree of reliability based on a planetary gearing. The unusually long service-life of these actuators and motor-driven actuators is achieved by the solid design of all power-transmission parts, i. e. by a certain version of the gearing kinematics optimized towards less relative motion under load and a lower specific edge loading. Furthermore, life-time lubrication reliably prevents wear and tear in any mounting position.

The step-down gearing is to reduce the motor speeds down to the available output-end speeds. This way, requirements as to long service lives, little torsional edge clearance, low noise generation are met.

The drive motor, designed as a canned motor of protection class IP 67, is dimensioned for motor-driven actuators so that, in operating modes S4 or S5 at ON-times of up to 35 % and frequencies of up to 1200 operating cycles per hour, a sufficient clearance towards the permissible winding temperature of temperature class F is maintained even in the case of a maximum admissible ambient temperature of 60 °C. The motor bearings are encapsulated and provided with life-time lubrication.

The first speed stage is designed to offer low mass inertia in order to achieve good start-up dynamics as well as noise attenuation with respect to the high drive speeds. The speed is reduced further in a single stage planetary gearing. The induction flux from the eccentric wheel flows to the planetary wheel – deflected at the ring gear which stands still during motor operation – and then over the coupling disc to the drive shaft.

In the case of slewing-motion actuators for control operations with low torque requirements, a similar gearing concept is used based on a stage-type planetary design and higher transmission rates.

In this gearing stage, high torques are present. In order to achieve a high degree of stability, a special type of gearing with wide tooth contact, high overlapping and a low surface speed is used. The transition from the driver pin to the coupling disc shows concave/convex contact surfaces and a high portion of planetary rolling. The entire gearing stage is characterized by low Hertz surface loading and a low surface speed. Thus, it offers enduring characteristics. The self-locking function of the overall drive is incorporated in this planetary stage.

The second degree of freedom of the planetary gearing is captured by the self-locking worm which is used for the handwheel emergency operation and also triggers the sensors for torque signalling since it functions as torque support for the ring gear. The worm is supported on prestressed laminated springs so that all torques below the maximum permissible control torque are measured without any shifting motion of the worm. In contrast with the usual shifting-worm drives, the measuring hysteresis is also minimized by the fact that with this concept no frictional forces due to circumferential torque forces need to be overcome.

The entire gearing space is provided with a life-time oil filling. Thermal dimensioning is such that even in the case of the operating mode described above there will be no early thermal damaging of sealing elements and oil filling.

13 Technical data

13.1 POWER SECTION

Voltage

Power–feed (preferred version),
other versions upon request 400 V AC \pm 10 %

Frequency range 50 Hz \pm 3 Hz
60 Hz \pm 3 Hz

Motor rating

Maximum admissible motor rating 8.5 kW

Ratings

cf. chapter "Application", Table 1

13.2 ELECTRONICS SECTION

Power supply (internal power supply unit)

Operating voltage USI 24 V
Power consumption of electronics equipment < 30 W
Reference potential, process side 0 V

INPUT/OUTPUT VALUES

Multi–purpose input (optional)

Operating mode of resistance thermometer (PT100)

Measuring input

| | |
|--|---------------------------------|
| Temperature range sensor | 0 ... 150 °C |
| Sensor resistance | 0 ... 160 Ω |
| Response resistance for short–circuit and wire break | < 20 Ω or > 180 Ω |
| Input resistance | > 10 M Ω |
| Measuring current | 2 mA |
| Line resistance (supply and return line) | \leq 100 Ω |

Accuracy

| | |
|---|--------|
| Accuracy, related to 100 % (over a temperature range of 0 ... 70 °C, ageing, voltage range) | < 1 % |
| Resolution for analog/digital conversion | 10 bit |

Operating mode of 4–wire–transducer (analog)

Transducer supply

| | |
|--------------------------------|------------|
| Output voltage (for I = 25 mA) | USI –4.5 V |
| Output voltage (for I = 50 mA) | USI –5.5 V |
| Output current | max. 50 mA |

Measuring input

| | |
|--|---------------------|
| Measuring range, analog value | 4 ... 20 mA |
| Maximum range | –1 ... +21 mA |
| Measuring resistor | 50 Ω |
| Destruction limits | \pm 50 mA |
| Line resistance (supply and return line) | \leq 100 Ω |

Accuracy

| | |
|---|---------|
| Accuracy, related to 100 % (over a temperature range of 0 ... 70 °C, ageing, voltage range) | < 1 % |
| Resolution for analog/digital conversion | 10 bits |

Operating mode of 2-wire-transducer (analog)

Transducer supply

| | |
|--------------------------------|------------|
| Output voltage (for I = 25 mA) | USI -4.5 V |
| Output voltage (for I = 50 mA) | USI -5.5 V |
| Output current | max. 50 mA |

Measuring input

| | |
|--|----------------|
| Measuring range, analog value | 4 ... 20 mA |
| Maximum range | -1 ... + 21 mA |
| Measuring resistor | 50 Ω |
| Destruction limits | ± 50 mA |
| Line resistance (supply and return line) | ≤ 100 Ω |

Accuracy

| | |
|---|---------|
| Accuracy, related to 100 % (over a temperature range of 0 ... 70 °C, ageing, voltage range) | < 1 % |
| Resolution for analog/digital conversion | 10 bits |

Operating mode of PTC thermistor (thermistor)
to DIN 44080 or IEC 34-11-2

| | |
|---------------------|------------|
| Switching threshold | 680 ± 30 Ω |
| Measuring current | 2 mA |

Operating mode of binary input (contact)

Contact supply

| | |
|--------------------------------|------------|
| Output voltage (for I = 25 mA) | USI -4.5 V |
| Output voltage (for I = 50 mA) | USI -5.5 V |
| Output current | max. 50 mA |

Measuring input

| | |
|--|---------------------|
| Signal level, "0" signal | 0 ... 3 V |
| "1" signal | 15 ... 30 V |
| Input resistance for "0" signal | 15 kΩ, +13 %, -10 % |
| for "1" signal | 5 ... 15 kΩ |
| Destruction limit | > 65 V |
| Line resistance (supply and return line) | ≤ 100 Ω |

Combined input (optional)Operating mode of binary input (contact)*Contact supply*

| | |
|--------------------------------|------------|
| Output voltage (for I = 25 mA) | US1 –4.5 V |
| Output voltage (for I = 50 mA) | US1 –5.5 V |
| Output current | max. 50 mA |

Measuring input

| | |
|--|------------------------------|
| Signal level, "0" signal | 0 ... 3 V |
| "1" signal | 11.2 ... 30 V |
| Input resistance | 15 k Ω , +13 %, –10 % |
| Destruction limit | > 65 V |
| Line resistance (supply and return line) | \leq 100 Ω |

Operating mode of analog input*Transducer supply*

| | |
|--------------------------------|------------|
| Output voltage (for I = 25 mA) | US1 –4.5 V |
| Output voltage (for I = 50 mA) | US1 –5.5 V |
| Output current | max. 50 mA |

Measuring input

| | |
|--|---------------------|
| Input current, nominal range | 4 ... 20 mA |
| Maximum range | –1 ... +21 mA |
| Measuring resistor | 50 Ω |
| Destruction limits | \pm 50 mA |
| Line resistance (supply and return line) | \leq 100 Ω |

Accuracy

| | |
|---|---------|
| Accuracy, related to 100 % (over a temperature range of 0 ... 70 °C, ageing, voltage range) | < 1 % |
| Resolution for analog/digital conversion | 10 bits |

Supply for fieldbus amplifier

| | |
|--------------------|-------------|
| Output voltage US1 | US1 – 2.5 V |
| Output current | max. 150 mA |

13.3 PROCONTROL P FIELDBUS

PROFIBUS based on PROFIBUS, DIN 19245

13.4 TEMPERATURE

Admissible ambient temperature – 25 ... + 60 °C for motor–driven actuators
– 25 ... + 70 °C for actuators

13.5 PROTECTION CLASS

IP 67

The drive complies with Machine Guideline 89/392/EWG.
As a stand–alone machine, PROPOS is marked with the CE sign.
PROPOS complies with the European standards and EMC guideline 89/336/EWG (as per 01.01.96) and Low–voltage guideline 73/23/EWG (as per 01.01.97).

Safe isolation between binary control and mains is provided acc. to VDE 0551.

Technical data are subject to change without notice!



ABB Utility Automation GmbH

P. O. Box 100351, D-68128 Mannheim
Phone (0621) 381 6544, Telefax (0621) 381 4372
Telex 462 411 107 ab d

Printed in Germany (UTA/FD22 1299)