

Sensyflow FMT200-ECO2

Thermal mass flowmeter



For air, integral mount design

Measurement made easy

—
Sensyflow FMT200-ECO2

Introduction

The Sensyflow FMT200-ECO2 is a very compact and highly dynamic mass flowmeter for air.

The Sensyflow FMT200-ECO2 enables direct mass or standard volume flow measurement in pneumatic applications, for example for the control of painting robots or in pressurized air systems.

Additional Information

Additional documentation on Sensyflow FMT200-ECO2 is available for download free of charge at www.abb.com/flow.

Alternatively simply scan this code:



Table of contents

1 Safety	3	6 Commissioning	12
General information and instructions	3	Checks prior to commissioning	12
Warnings.....	3	Switching on the power supply	12
Intended use.....	3	Inspection after power-up of the power supply	12
Improper use.....	3	Status LED on the transmitter.....	12
Warranty provisions.....	4	Install the parameterization program	13
Cyber security disclaimer.....	4	Start the parameterization program.....	13
Software downloads.....	4	Parameter overview.....	14
Manufacturer's address	4	Parameter descriptions	15
Service address	4	Saving the parameterization.....	15
2 Design and function	5	Menu bar	15
Overview	5	'Current Device Data' Registration Tab (Start screen).....	17
Device description	6	'Analog output' Registration Tab	20
3 Product identification	7	'Digital output' Registration Tab.....	22
Name plate	7	7 Operation	24
4 Transport and storage	7	Safety instructions	24
Inspection.....	7	8 Diagnosis / Troubleshooting	24
Transport.....	7	General.....	24
Storing the device.....	7	Status LED on the transmitter.....	24
Ambient conditions.....	7	9 Maintenance / Repair	25
Returning devices	7	General.....	25
5 Installation	8	Cleaning.....	25
Safety instructions	8	Returning devices	25
Installation conditions.....	8	10 Dismounting and disposal	26
Mounting position.....	8	Dismounting.....	26
Inlet sections.....	8	Disposal.....	26
Ambient conditions	9	11 Accessories	27
Storage temperature range	9	Sensor	27
Ambient temperature	9	Small flange connections.....	28
IP rating.....	9	Screwed connections and adapter	29
Process conditions	9	12 Specification	30
Measured medium temperature.....	9	13 Additional documents	30
Measuring medium pressure	9	14 Appendix	31
Influences.....	9	Return form.....	31
Installing the sensor	9		
Install the sensor:	9		
Electrical connections	10		
Terminal layout.....	10		
Electrical data for inputs and outputs	10		
Parameterize	11		
Parameterization set	12		

1 Safety

General information and instructions

These instructions are an important part of the product and must be retained for future reference.

Installation, commissioning, and maintenance of the product may only be performed by trained specialist personnel who have been authorized by the plant operator accordingly. The specialist personnel must have read and understood the manual and must comply with its instructions.

For additional information or if specific problems occur that are not discussed in these instructions, contact the manufacturer. The content of these instructions is neither part of nor an amendment to any previous or existing agreement, promise or legal relationship.

Modifications and repairs to the product may only be performed if expressly permitted by these instructions.

Information and symbols on the product must be observed.

These may not be removed and must be fully legible at all times.

The operating company must strictly observe the applicable national regulations relating to the installation, function testing, repair and maintenance of electrical products.

Warnings

The warnings in these instructions are structured as follows:

DANGER

The signal word '**DANGER**' indicates an imminent danger. Failure to observe this information will result in death or severe injury.

WARNING

The signal word '**WARNING**' indicates an imminent danger. Failure to observe this information may result in death or severe injury.

CAUTION

The signal word '**CAUTION**' indicates an imminent danger. Failure to observe this information may result in minor or moderate injury.

NOTICE

The signal word '**NOTICE**' indicates possible material damage.

Note

'**Note**' indicates useful or important information about the product.

Intended use

Mass flow measurement of gases and gas mixtures in closed pipelines.

The device has been designed for use exclusively within the technical limit values indicated on the identification plate and in the data sheets.

Improper use

The following are considered to be instances of especially improper use of the device:

- Operation as a flexible compensating adapter in piping, for example for compensating pipe offsets, pipe vibrations, pipe expansions, etc.
- For use as a climbing aid, for example for mounting purposes.
- For use as a bracket for external loads, for example as a support for piping, etc.
- Material application, for example by painting over the housing, name plate or welding/soldering on parts.
- Material removal, for example by spot drilling the housing.

... 1 Safety

Warranty provisions

Using the device in a manner that does not fall within the scope of its intended use, disregarding this manual, using underqualified personnel, or making unauthorized alterations releases the manufacturer from liability for any resulting damage. This renders the manufacturer's warranty null and void.

Cyber security disclaimer

This product is designed to be connected to and to communicate information and data via a network interface. It is operator's sole responsibility to provide and continuously ensure a secure connection between the product and your network or any other network (as the case may be).

Operator shall establish and maintain any appropriate measures (such as but not limited to the installation of firewalls, application of authentication measures, encryption of data, installation of anti-virus programs, etc.) to protect the product, the network, its system and the interface against any kind of security breaches, unauthorized access, interference, intrusion, leakage and/or theft of data or information.

ABB and its affiliates are not liable for damages and/or losses related to such security breaches, any unauthorized access, interference, intrusion, leakage and/or theft of data or information.

Software downloads

By visiting the web pages indicated below, you will find notifications about newly found software vulnerabilities and options to download the latest software. It is recommended that you visit this web pages regularly:

www.abb.com/cybersecurity

[ABB-Library – Sensyflow FMT200-ECO2 – Software Downloads](#)



Manufacturer's address

ABB AG

Measurement & Analytics

Schillerstr. 72
32425 Minden
Germany

Tel: +49 571 830-0

Fax: +49 571 830-1806

Service address

Customer service center

Tel: +49 180 5 222 580

Email: automation.service@de.abb.com

2 Design and function

Overview



Figure 1: Sensor with different screw-in adapter (examples)

Design	Integral mount design
Model	Sensyflow FMT200-ECO2
Measuring media	Air
Measuring accuracy*	Measuring error < $\pm 3\%$ of measured value, repeatability < $\pm 0.5\%$ of measured value
Permissible measuring medium temperature T_{medium}	-25 to 50 °C (-13 to 122 °F)
Permissible operating pressure	Standard: 10 × 102 kPa (10 bar abs.) High-pressure version: 16 × 102 kPa (16 bar abs.)
Process connections	Small flange adapter ISO-KF flange; screwed connection G $\frac{3}{8}$ in, G $\frac{1}{4}$ in, G $\frac{1}{2}$ in, G 1 in; Legris hose adapter, Transair adapter
Wetted materials	Aluminum, Hostadur, tinned Cu, glass
Power supply	24 V DC, $\pm 10\%$
IP rating	in accordance with EN 60529: IP 65
Communication	serial, V24 / RS232C
Outputs in serial production	
Analog outputs	0 to 5 V DC, 0 to 10 V DC, 0/4 to 20 mA, min. / max. alarm
Digital output	Yes
Pulse / frequency output	Yes
Approvals and certificates	Available on abb.com/flow or on request

* The stated measuring accuracy only applies under the calibration conditions in the stated measuring range.

... 2 Design and function

Device description



- ① Process adapter connection ③ Electric coupler connector
 ② Status LED

Figure 2: Device design

The Sensyflow FMT200-ECO2 is a compact, highly dynamic measuring system for mass flow or standard volume flow measurement of air.

The flowmeter sensor has been designed in the form of an easy-to-install meter tube which accommodates the sensor unit and the evaluation electronics. It directly provides a linearized output signal, and is calibrated and immediately ready for use.

A standard RS 232 interface allows you to change over between the individual output signals (current, voltage, frequency, pulse and alarm) and parameterize the device.

Thanks to its flexible connection concept, the measuring system can be installed in piping or hoses of different types and sizes. A variety of connection adapters are available for this purpose.

A standard power supply unit can be used to supply power to the Sensyflow FMT200-ECO2.

Physics of measurement

Thermal flow metering procedures use different ways to evaluate the flow dependent cooling of a heated resistor as measuring signal.

In a hotfilm anemometer with temperature difference control, the heated platinum resistor is maintained at a constant overtemperature in relation to an unheated platinum sensor inside the gas flow. The heating power required for maintaining the overtemperature depends directly on the flow rate and the material properties of the gas. Given a known (and constant) gas composition, the mass flow can be determined by electronically evaluating the heater current /mass flow curve without additional pressure and temperature compensation. Together with the standard density of the gas this results directly in the standard volume flow. Considering the high measuring range dynamics up to 1:100, an accuracy smaller than 1 % of the measuring value is achieved.

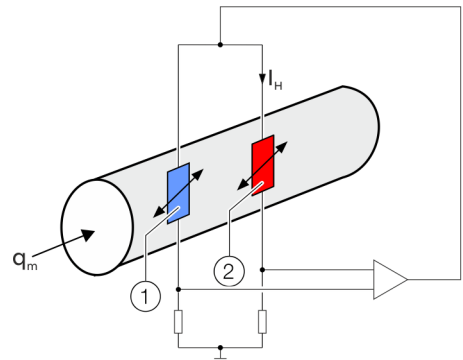

- ① Gas temperature measurement resistor (R_{MG}) q_m Gas mass current
 ② Heating resistor (R_H) I_H Heating actual value

Figure 3: Analog measuring principle

The gas flows past two temperature-sensitive resistors, R_H and R_{MG} , which are part of an electric bridge circuit. Due to the chosen resistance ratio $R_H < R_{MG}$, R_H is heated by the current I_H . R_{MG} adopts the same temperature as the gas. The current I_H is preset by the electronic control circuit to produce a constant temperature difference between the heated resistor R_H and the temperature of the gas.

The electric power generated in resistor R_H exactly compensates its loss of heat to the gas flow. As this loss of heat is dependent on the number of particles which collide with the surface of resistor R_H , I_H represents a measure of the mass flow rate.

3 Product identification

Name plate

Note

The name plates displayed are examples. The device identification plates affixed to the device can differ from this representation.

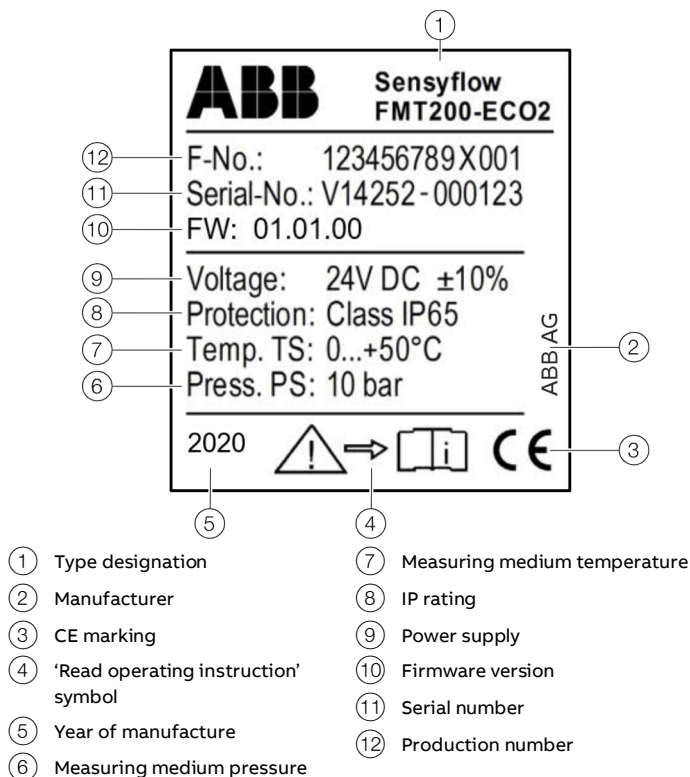

Figure 4: Name plate (sample)

4 Transport and storage

Inspection

Check the devices immediately after unpacking for possible damage that may have occurred from improper transport. Details of any damage that has occurred in transit must be recorded on the transport documents. All claims for damages must be submitted to the shipper without delay and before installation.

Transport

If the original packaging material is no longer available, wrap the device in bubble wrap or corrugated cardboard and place it in a box of sufficient size lined with a shock-absorbing material (e.g., foam rubber). The thickness of the padding should be appropriate for the device weight and type of shipment. The box must be labeled as "fragile".

For overseas shipment, always add a desiccant (e.g., silica gel) and hermetically seal the device plus desiccant in a layer of polythene that is 0.2 mm thick. Use an amount of desiccant that is appropriate for the packing volume and the expected transport time (at least for three months). You should also line the box with a layer of union paper.

Storing the device

Bear the following points in mind when storing devices:

- Store the device in its original packaging in a dry and dust-free location.
- Observe the permitted ambient conditions for transport and storage.
- Avoid storing the device in direct sunlight.
- In principle, the devices may be stored for an unlimited period. However, the warranty conditions stipulated in the order confirmation of the supplier apply.

Ambient conditions

Refer to **Ambient conditions** on page 9.

Returning devices

For the return of devices, follow the instructions in **Returning devices** on page 25.

5 Installation

Safety instructions

WARNING

Risk of injury due to live parts.

Improper work on the electrical connections can result in electric shock.

- Connect the device only with the power supply switched off.
- Observe the applicable standards and regulations for the electrical connection.

WARNING

Risk of injury due to process conditions.

The process conditions, for example high pressures and temperatures, toxic and aggressive measuring media, can give rise to hazards when working on the device.

- Before working on the device, make sure that the process conditions do not pose any hazards.
- If necessary, wear suited personal protective equipment when working on the device.
- Depressurize and empty the device / piping, allow to cool and purge if necessary.

Installation conditions

Mounting position

Any mounting position can be selected.

Inlet sections

To prevent negative effects on measuring accuracy, the ISO-KF flange DN 25, Transair, G $\frac{3}{4}$ in and G 1 should be provided in the inlet sections when using the connections.

Straight undisturbed pipe sections must be provided as inlet sections; they should have a length of approx. $10 \times D$ on the inlet side.

These inlet sections make sure that any disturbances of the flow profile are eliminated before reaching the actual measuring point at the sensor.

If maintaining the required inlet sections is not possible, a flow conditioner can be retrofitted. However, the flow conditioner causes a significantly increased pressure drop.

When using the G $\frac{1}{2}$ in and G $\frac{3}{8}$ in adapters, no additional inlet sections are required, as flow straightener components are implemented on the inlet side of the adapters. Note that flow conditioners cause considerable pressure drop.

Installation of setting equipment

Components affecting the flow, e.g. valves or shut-off valves should be installed on the outlet side, therefore downstream of the measuring point.

Ambient conditions

Storage temperature range

-30 to 85 °C (-22 to 185 °F)

Ambient temperature

-25 to 50 °C (-13 to 122 °F)

IP rating

IP 65

Process conditions

Measuring medium

Air

Measuring ranges*

0 (1) to 100 kg / h or 0 (12) to 1250 NI / min**

* Reference values are given for applications with air under atmospheric conditions. The values in brackets indicate the low limit of the measuring range for which the measured value accuracy indicated is specified.

** You can specify any unit, as long as it can be transformed into a mass or standard volume flow. (notation also: l / min-qn).

Measured medium temperature

-25 to 50 °C (-13 to 122 °F)

Measuring medium pressure

Standard: 10 × 102 kPa (10 bar abs.)

High-pressure version: 16 × 102 kPa (16 bar abs.)

Influences

Temperature effect

< 0.1 % / K of measured value

Pressure effect

≤ 0.2 % / 100 kPa (/bar) of the measured value

Pressure drop

< 10 kPa (100 mbar) at full scale and using the small flange adapter DN 25; decreasing approx. quadratically at smaller flow rates.

Installing the sensor

Before installing the sensor, observe the following points:

- The ambient conditions at the installation site comply with the requirements in **Ambient conditions** on page 9.
- The operating pressure complies with the requirements in **Measuring medium pressure** on page 9
- For each measuring system a calibration certificate is delivered which contains all the key information (such as serial number, calibrated measuring range, order number, outputs set in delivery status). It must be checked whether this data complies with the requirements of the measuring point.

Install the sensor:

1. Install the sensor with process adapters in the piping.
2. Create the electrical connections in accordance with the information **Electrical connections** on page 10.

Note

The variable process adapters are fastened in the sensor with a fine pitch thread. The connection can be cautiously loosened using a SW 30 open-end wrench.

Before carefully reinserting the process adapters, the threads should be cleaned and lightly lubricated. Make sure the O-ring is seated properly.

... 5 Installation

Electrical connections

Terminal layout

Please use the supplied cable for the electrical connection of the flowmeter sensor. It is connected to the sensor with the plug.

Use a 24 V DC power supply with safe isolation in accordance with EN 61010 and IEC 950 with a maximum output power of < 150 W only.

Note

The Sensyflow eco1 and Sensyflow FMT200-ECO2 measuring systems are compatible. With use of the appropriate adapter plug, the Sensyflow FMT200-ECO2 can be connected to existing installations.

As the 'interface' and 'digital output' functionalities are not available in Sensyflow eco1, they are not wired-on in the adapter plug.

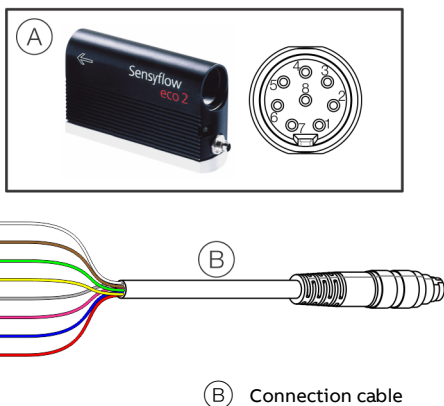

(A) Sensor

(B) Connection cable

Figure 5: Electrical connection

Coupler connector

Sub-D connector, series 712, 8-pin, IP 65

Pin	Color	Function / comments
1	White	Analog output, signal (+)
2	Brown	RS 232C TxD – transmi data
3	Green	Pulse / frequency output, signal (+)
4	Yellow	Power supply +24 V DC
5	Gray	Power supply GND
6	Pink	RS 232C RxD – receive data
7	Blue	Analog output, GND
8	Red	Pulse / frequency output + RS 232C, GND
Shield	—	Functional earth

Note

Insulate any unused wire ends.

Electrical data for inputs and outputs

Power supply

Integral mount design

Pin / color	4+ (yellow) / 5- (gray)
Operating voltage	24 V DC ($\pm 10\%$)
Input Current	Peak < 1 A; operation < 0.6 A
Fuse	At least 2 A slow-blow
Power consumption	< 15 W

Analog output

Can be optionally configured as current output (0 (4) to 20 mA) or voltage output (0 to 10 (5) V).

Current output

active*

Pin / color	1+ (white) / 7- (blue)
Output signal	0 (4) to 20 mA
Signal in the event of an error	< 3.5 mA or > 22 mA
Load R_B	< 500 Ω

Voltage output

Active

Pin / color	1+ (white) / 7- (blue)
Output signal	0 to 10 (5) V
Signal in the event of an error	Min. or max.
Input Current	< 1 mA

* When selecting the current output 0 (4) to 20 mA, the analog output supplies an active signal. The device delivers the current independently without external power supply.

Digital output

Can be configured as pulse / frequency outputs or binary outputs.

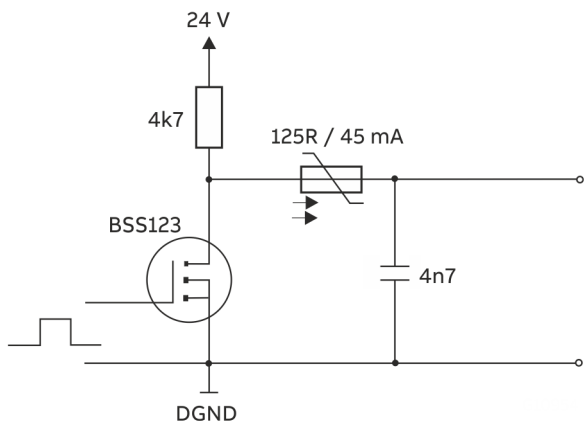

Figure 6: Connection example

The digital output offers a 24 V HIGH signal or a 0 V LOW signal. The output can be wired as active or passive.

Digital output (passive)

Pin / color 3+ (green) / 8- (red)

U_{max} 24 V DC

I_{max} -20 mA

f_{max} 2500 Hz

The output current must be limited to -20 mA in LOW state to guarantee an output voltage of $U_a < 2.5$ V.

Digital output (active)

Pin / color 3+ (green) / 8- (red)

I_{max} 1 mA

f_{max} 2500 Hz

The output current must be limited to 1 mA in HIGH state to guarantee an output voltage of $U_a > 15$ V.

Communication

RS 232

Pin / color TxD: 2 (brown) / RxD: 6 (pink) / GND: 8- (red)

Baud rate 9600 bits/sec.

Stop bits 1

Parity None

Data bits 8

Parameterize

The Sensyflow FMT200-ECO2 can simultaneously operate one analog output (current 0 / 4 to 20 mA or voltage 0 to 5 / 10 V), one digital output (frequency, pulse, alarm) and a serial RS 232 interface.

Parameterization of the measuring system can also take place via the serial interface. Using a PC or laptop, you can change the output signal used or the adjust the settings of the measuring ranges and signals.

The parameterization program can be downloaded from the ABB Library:

[ABB-Library – Sensyflow FMT200-ECO2 – Software Downloads](#)



A service and parameterization box (D-Sub Adapter and USB/RS232 adapter) is optionally available for easier connection of the SensyFlow FMT200-ECO2 in the test field. That way, the various input and output variables can be read out and set quickly and easily.

... 5 Installation

... Parameterize

Parameterization set

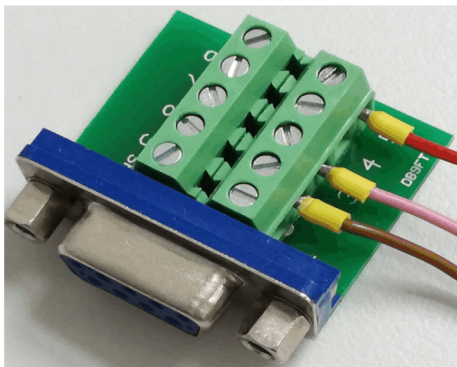

Figure 7: D-Sub Adapter

D-Sub Adapter electrical connection

Wire color	Terminal no. on the female connector	Signal
Brown	2	RS 232 / TxD
Pink	3	RS 232 / RxD
Red	5	RS 232 / GND

USB 2.0, serial adapter



Figure 8: Adapter

6 Commissioning

Checks prior to commissioning

The following points must be checked before commissioning the device:

- Correct wiring in accordance with **Electrical connections** on page 10.
- The ambient conditions must comply with the requirements in **Ambient conditions** on page 9.
- The power supply must meet the requirements set out on the name plate.

Switching on the power supply

1. Switch on the power supply.
 - The status LED blinks red during the initialization phase (approx. 30 s).
 - After the initialization phase, the status LED lights up in a continuous green color.
2. Perform parameterization of the flowmeter (see **Parameterize** on page 11).

The flowmeter is now ready for operation.







Inspection after power-up of the power supply

The following points must be checked after commissioning the device:

- Parameter configuration must correspond to the operating conditions.

Status LED on the transmitter

The status LED on the transmitter indicates the operating condition of the device and displays possible faults.

LED	Description
Continuous green light 	The sensor is ready for operation.
Green flashing 	The measuring range set has been up-scaled.
Continuous red light 	Parameter or hardware fault on the sensor. <ul style="list-style-type: none"> • Reestablish parameterization, see Reestablish the parameterization on page 15. • Repairs required, contact ABB Service.
Red blinking 	Initialization phase of the device. (approx. 30 s after power-up of the power supply or after parameter changes)
Red slowly blinking 	Undervoltage. Check the supply power
Red quickly blinking 	EEPROM fault. Repairs required, contact ABB Service.

Install the parameterization program

The parameterization program is located on the provided USB stick.

The parameterization program must be installed on a PC / laptop:

1. Insert the USB stick into the PC / laptop.
2. Open the USB stick in Explorer.
3. Launch the '**SETUP.EXE**' file with administrator rights.
4. Follow the instructions in the installation program.
Change the preset installation directory as needed.
5. Select the desired language (German, English or French).
The language can be changed in the parameterization program only.

Start the parameterization program

1. Connect the sensor to an open RS232 interface of the PC / laptop using the D-Sub adapter. If no RS232 interface is available, additionally use the USB-RS232 adapter.
2. Power-up the power supply of the sensor.
3. To launch the parameterization program, execute the '**P_Compact_Vxxx.exe**' file in the installation directory.
- The COM 1 interface is used by default. If another interface is used, select it in the '**Connection**' menu.

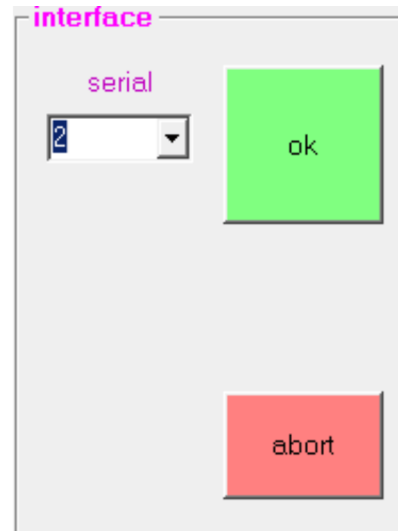

- Confirm the selected interface by pressing '**OK**'. If no connection can be established, an error message will appear. In this case, check the following points:
 - Check the interface connection with the PC / laptop.
 - Is the sensor ready for operation?
(Is the status LED on the sensor continuous green)
 - Has the correct interface been selected.
- If the interface connection has been successfully established, the starting screen of the parameterization program is displayed (see '**Current Device Data**' **Registration Tab (Start screen)** on page 17).

... 6 Commissioning

Parameter overview

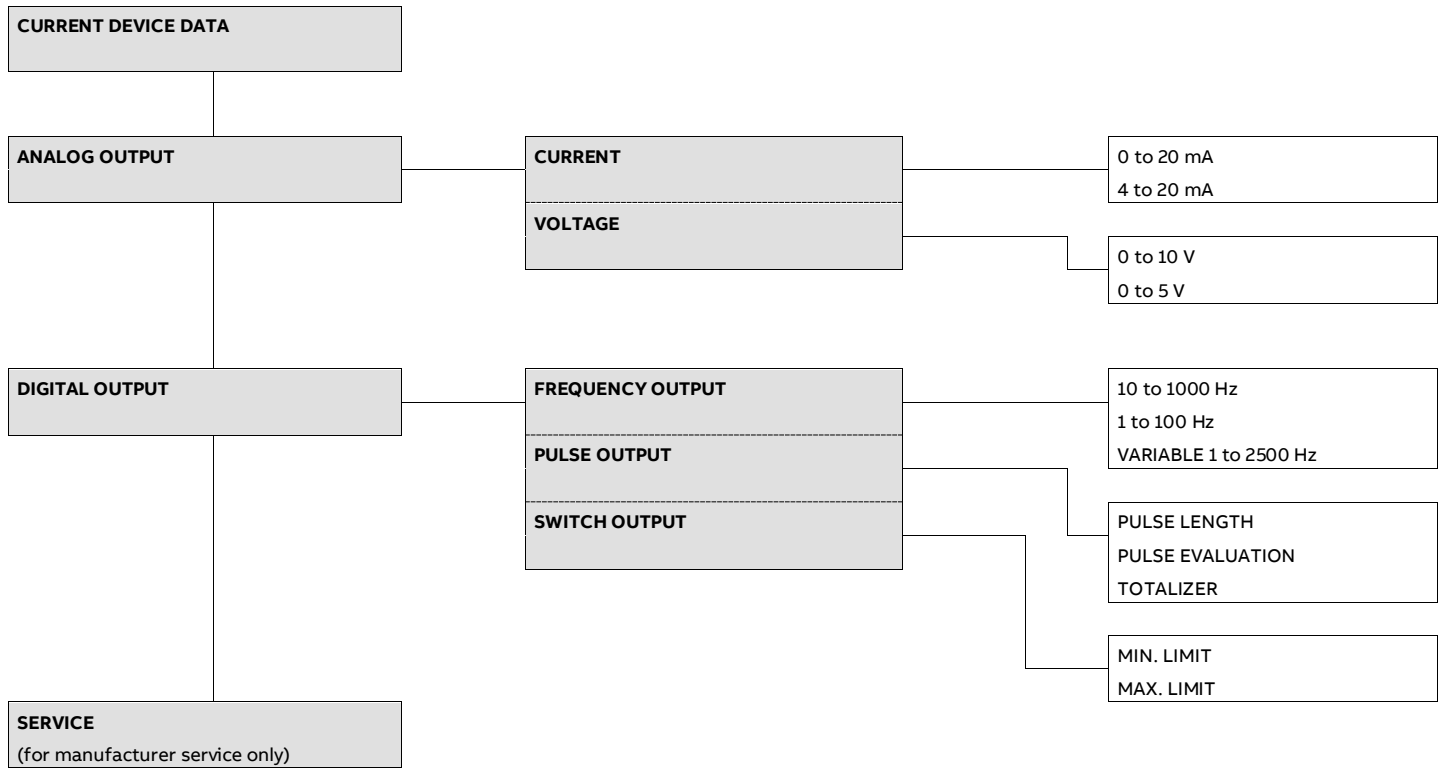

Parameter descriptions

NOTICE

Data loss

Data loss due to the shut-off of power supply during the initialization phase (status LED blinks red) of the device.

- Do not switch off the power supply until the device is ready for operation(status LED is continuous green).

Saving the parameterization

If any parameterization has been changed in the parameterization program and transferred to the device through the **'Accept'** button, a save / initialization phase of the device follows and the status LED blinks red.

- The supply voltage must not be switched off until the status LED is continuous green once more.

The modified parameters will not be saved properly if this rule is not obeyed.

After the repeated power-up of the device, a data inconsistency will be detected during the initialization phase, the status LED will switch to continuous red and the device will no longer function correctly.

Reestablish the parameterization

Once the status LED is continuous red, communication with the parameterization software can be resumed.

- The parameterization data must be resaved by selecting the **'Accept'** button.
 - Wait until the symbol indicating that a program is running disappears and the status indication for the 'initialization phase' is terminated.
 - The status LED is still continuous red at this stage.
- Perform a hardware reset by powering down and powering up the power supply.
 - After the initialization phase, the status LED is continuous green and the device is ready for operation.

Note

If operation readiness cannot be reestablished, contact ABB Service.

Menu bar

Menu / parameter	Description
Configuration	
Factory settings	Shows the parameters set at the factory
Savings	Saves the current parameter set to a data storage medium.
Load	Loads a saved parameter set from a data storage medium.
Delete	Deletes a saved parameter set from a data storage medium.
Print	Prints the current parameter set to the configured standard printer.
Select Language	Select the program language: German, English, French
Select unit	Select the flow unit from a unit list.
Insert / delete unit	Create / delete a new unit. Refer to Add user-defined unit on page 16.
Exit	Exits the parameterization program.
Connection	
Connection	Select the serial interface for connection with the sensor.
Data backup	
Data backup	Save the changed data to the device

... 6 Commissioning

... Parameter descriptions

Add user-defined unit

The 'add unit' dialog box includes the following elements:

- Unit:** A text input field for the unit name.
- Factor:** A text input field for the conversion factor.
- Stand.spec.:** A text input field for the standard state.
- Gas type:** A text input field for the gas type.
- exist units:** A list of existing units, including:
 - kg/h () Luft
 - kg/min () Luft
 - g/s () Luft
 - Nm3/h (0° C / 1013 mbar) Luft
 - Nm3/h (20° C / 1013 mbar) Luft
 - Nm3/h (15° C / 1013 mbar) Luft
 - NI/h (0° C / 1013 mbar) Luft
 - NI/h (20° C / 1013 mbar) Luft
- Buttons:** 'abort' (red) and 'save' (green).

Figure 9: 'Add unit' menu

A user-defined unit can be created here. The unit must have the possibility of being presented as a multiple of kg/h.

Parameter	Description
Unit	Name of the unit (text field).
Factor	Enter the factor of the unit in kg/h. Decimal numbers must be entered using a period rather than a comma.
Standard condition	Enter the standard state to which the unit makes reference. Example: 0 °C, 1013mbar
Gas type	Enter the gas type for the unit (text field).
Available units	Display the available units.
Cancel	Cancel the entry.
Savings	Save the new unit.
Delete unit	Delete units

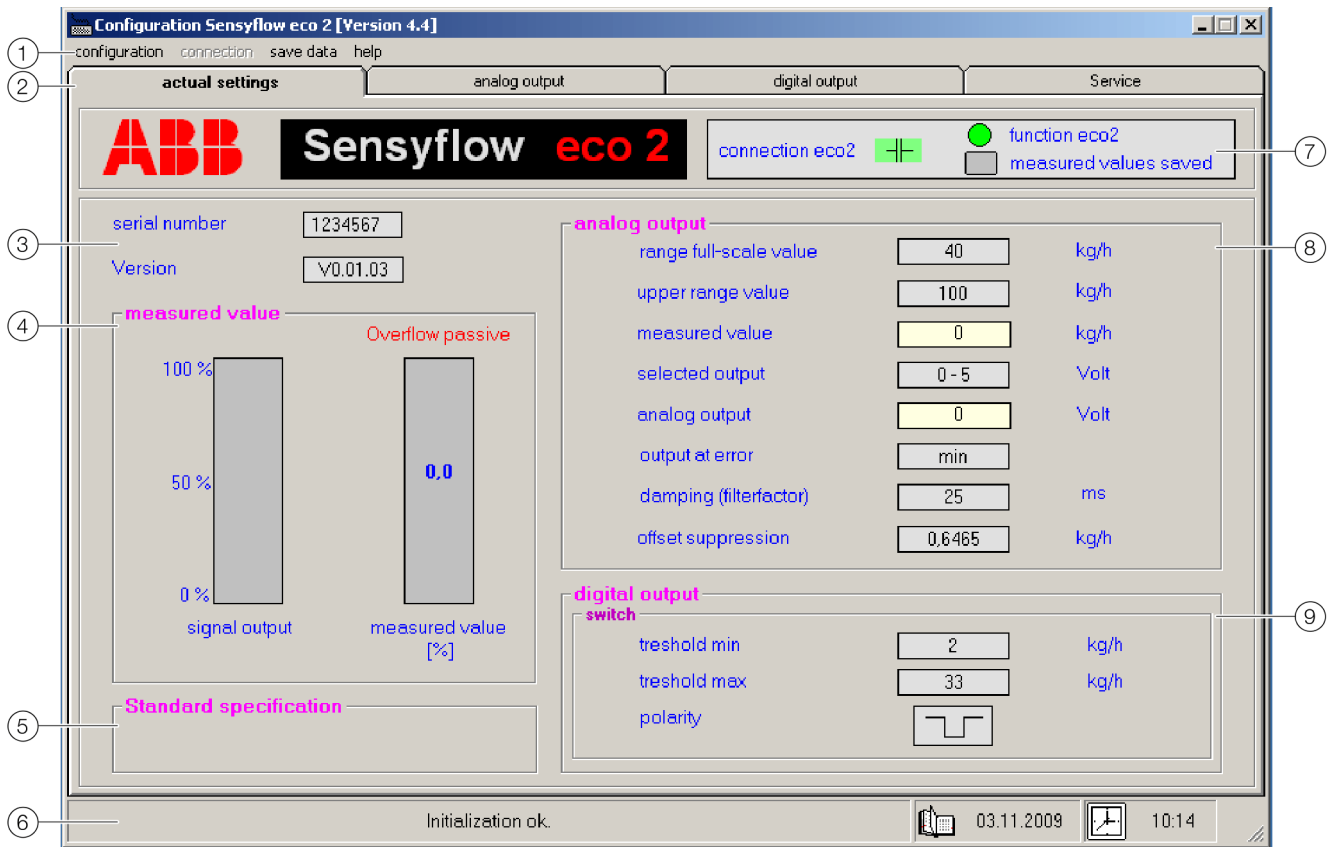
'Current Device Data' Registration Tab (Start screen)

- | | |
|---|---|
| ① Menu bar | ⑥ Status bar |
| ② Registration Tab | ⑦ Sensor connection status |
| ③ Device identification | ⑧ Analog output parameter display |
| ④ Current measured value | ⑨ Digital output parameter display (only if configured) |
| ⑤ Standard condition parameter display (when selecting a volume unit) | |

Figure 10: Parameterization program, 'Current Device Data' Registration Tab

... 6 Commissioning

... Parameter descriptions

Device detection

Display information on the connected sensor.

Parameter	Description
Production number	Unique serial number of the connected sensor, please provide this number with any inquiry to ABB.
Version	Sensor firmware software version.

Measured value

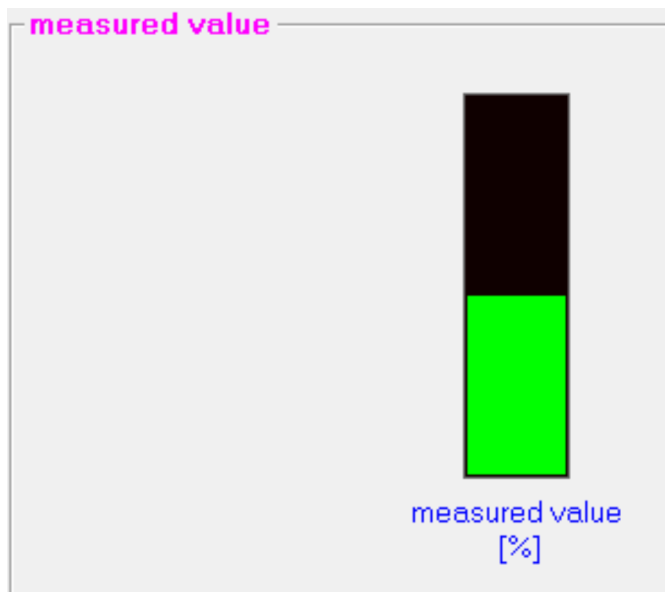

Figure 11: 'Measured value' field

In the measured value area, the current measured value is displayed in % as a bar graph.

If the digital output of the sensor is configured as a switch output (see 'Switch output' option on page 23), the graph displays the up-scale or down-scale of the set limit value:

- If the current measured value down-scales the set lower limit, the bar has a **blue** color.
- If the current measured value up-scales the set upper limit, the bar has a **red** color.
- If the current measured value is within the set limits, the bar has a **green** color.

Standard condition

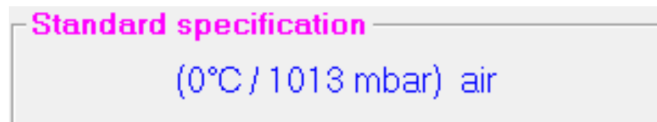

Figure 12: Standard condition field

When a volume unit is selected (e.g. Nm³/h), the unit always makes reference to a defined standard condition. In the standard condition field, the absolute pressure and reference temperature for the selected volume unit is displayed. When a mass flow unit is selected (e.g. kg/h) the field remains empty.

Status bar

Display of information and help texts for the current action. In addition, the current date and time are displayed.

Digital output

Display of the digital output configuration.

Frequency output option:



Figure 13: Frequency option

The current measured value is output as a frequency on the digital output.

Parameter	Description
Frequency [min]	Frequency in Hz for '0' flow.
Frequency [max]	Frequency in Hz for the set upper range value.

Impulse output option:

digital output
impulse

value	<input type="text" value="1"/>	kg/Puls
length	<input type="text" value="250"/>	ms
polarity		

Figure 14: Impulse output

The current measured value is output in impulses/unit on the digital output.

Parameter	Description
Value	Set flow rate per impulse.
Duration	Set impulse length.
Polarity	Set polarity (low/high) for the impulse.

Switch option:

digital output
switch

threshold min	<input type="text" value="10"/>	kg/h
threshold max	<input type="text" value="110"/>	kg/h
polarity		

Figure 15: Switch

The current measured value is monitored for fluctuation either side of an adjustable limit value.

The polarity gives the condition of the signal within the set limits.

Parameter	Description
Threshold min	Set lower limit value.
Threshold max	Set upper limit value.
Polarity	Set polarity (low/high).

... 6 Commissioning

... Parameter descriptions

'Analog output' Registration Tab

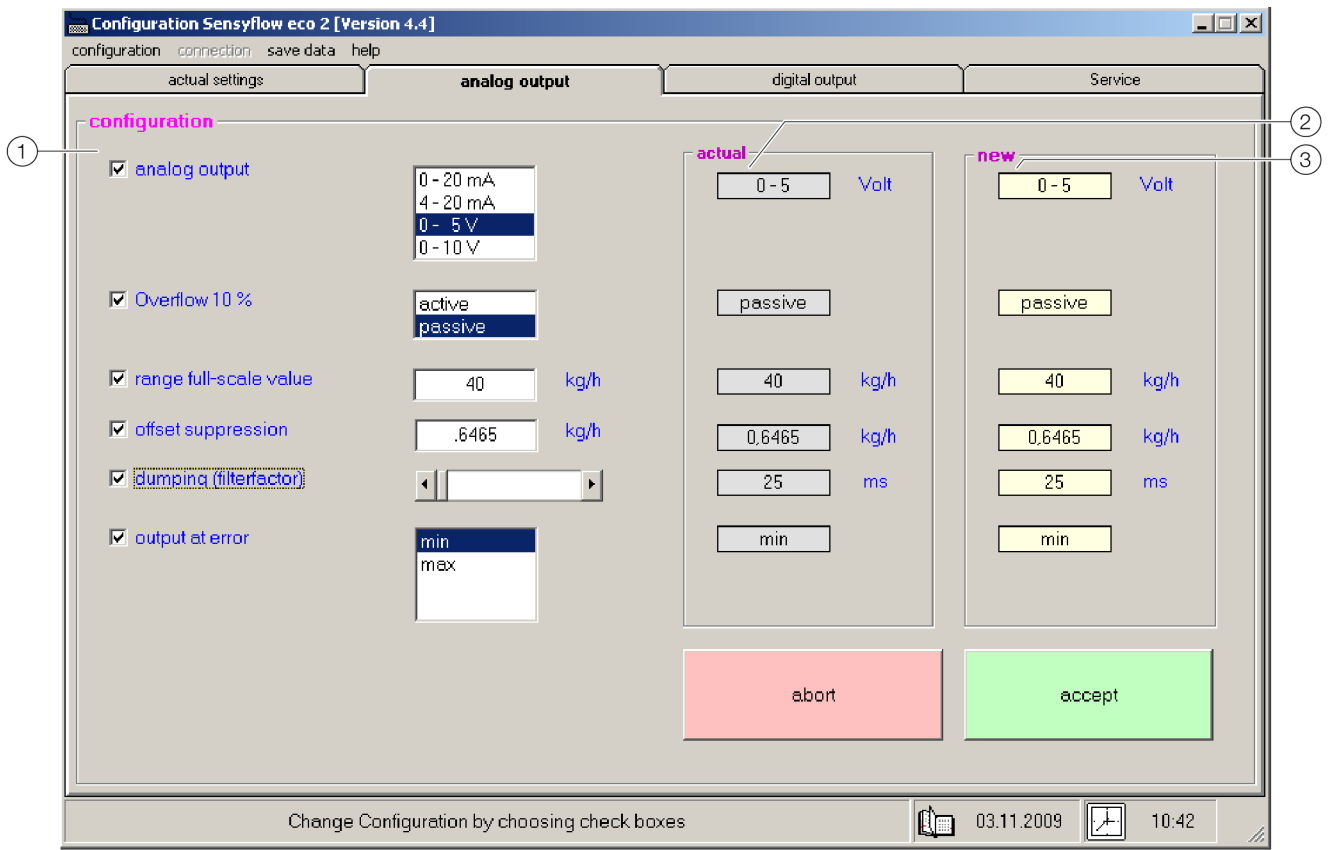

- ① 'Configure' area, selection of the parameters to be configured via check box / .
- ② Display of the currently set values
- ③ Display of the newly selected values

Figure 16: Parameterization program, 'Analog Output' Registration Tab

This tab is used to configure the analog output. For the sake of transparency, both the current and amended values are displayed at the same time.

- The parameters to be changed should be selected using the check box and the values changed in the entry field.
- The changed values are saved to the sensor using the **'Accept'** button.
The sensor is restarted and initialized (LED on the transmitter blinks red). No measured values are displayed during initialization.

Parameter for the analog output

Parameter	Description
Analog output	Select the operating mode for the analog output: 0-20 mA, 4-20 mA, 0-5 V, 0-10 V
Upper range value	Set the flow rate for the maximum current / maximum voltage on the analog output.
Low flow	Set the flow rate below which no measurement is made (measured value = 0 %)
Filter factor	Set the time constant for the damping of the output signal in ms.
Output in the event of an error	Select the output behavior in the event of an error. <ul style="list-style-type: none"> • Min: Analog output 0 % • Max: Analog output 100 % • Up: Analog output > 22.5 mA* • Down: Analog output < 3.5 mA** **

* not for operating mode 0-5 V, 0-10 V

** not for operating mode 0-20 mA

... 6 Commissioning

... Parameter descriptions

'Digital output' Registration Tab

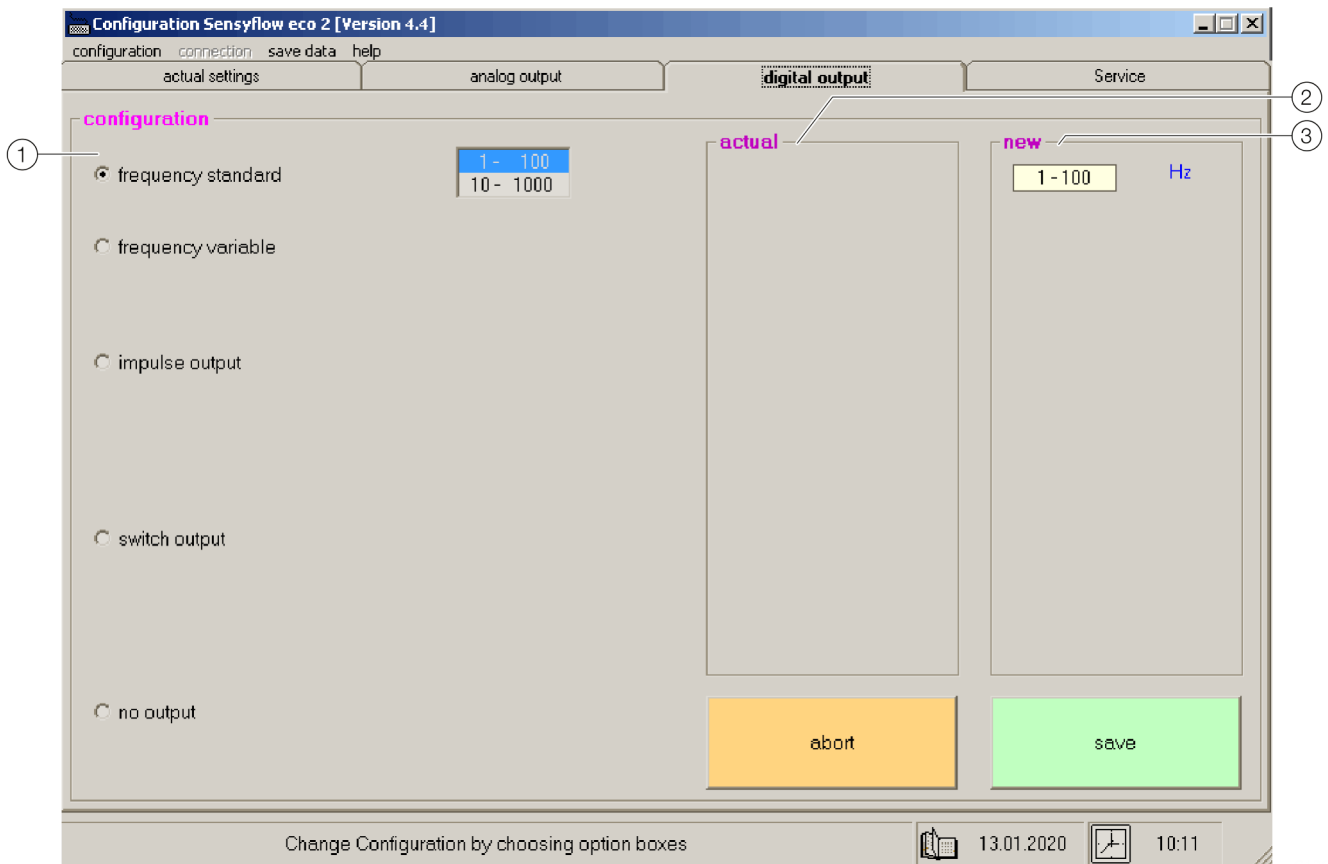

- ① 'Configure' area, selection of the parameters to be configured via check box / .
- ② Display of the currently set values
- ③ Display of the newly selected values

Figure 17: Parameterization program, 'Digital Output' Registration Tab

This tab is used to configure the digital output. For the sake of transparency, both the current and amended values are displayed at the same time.

- The parameters to be changed should be selected using the check box and the values changed in the entry field.
- The changed values are saved to the sensor using the **'Accept'** button.
The sensor is restarted and initialized (status LED on the transmitter blinks red). No measured values are displayed during initialization.

Digital output

Configuration of the digital output.

'Standard Frequency' option

Figure 18: Standard Frequency output

In the **'Standard Frequency'** operating mode, you can switch between two frequency ranges **1 to 100 Hz** or **10 to 1000 Hz**. The lower frequency corresponds to a flow rate of 0 %, while the upper frequency corresponds to a flow rate of 100 % of the set upper range value.

'Variable Frequency' option

Figure 19: Variable Frequency output

In the **'Variable Frequency'** operating mode, you can enter any lower and upper frequency. The lower frequency corresponds to a flow rate of 0 %, while the upper frequency corresponds to a flow rate of 100 % of the set upper range value.

Parameter	Description
min	Enter the frequency for 0 % flow rate
max	Enter the frequency for 100 % flow rate, maximum 2500 Hz

'Impulse output' option

Figure 20: Impulse output

The current measured value is output in impulses/unit on the digital output.

Parameter	Description
Value	Enter the flow rate per impulse.
Duration	Set the impulse length.
Polarity	Select polarity (low/high) for the impulse.

'Switch output' option

Figure 21: Switch output

The current measured value is monitored for fluctuation either side of an adjustable limit value.

The polarity gives the condition of the signal within the set limits.

Parameter	Description
Lower threshold	Enter the lower limit value.
Upper threshold	Enter the upper limit value.
Polarity	Select polarity (low/high).

'No output' option

Deactivates the digital output.

7 Operation

Note

The device does not have operating elements for parameterization on site.

Operation and configuration is performed through the parameterization program, see **Commissioning** on page 12.

Safety instructions

If there is a chance that safe operation is no longer possible, take the device out of operation and secure it against unintended startup.







8 Diagnosis / Troubleshooting

General

Error messages and device disruptions are indicated via the status LED on the sensor.

Status LED on the transmitter

The status LED on the transmitter indicates the operating condition of the device and displays possible faults.

LED	Description
Continuous green light 	The sensor is ready for operation.
Green flashing 	The measuring range set has been up-scaled.
Continuous red light 	Parameter or hardware fault on the sensor. <ul style="list-style-type: none"> • Reestablish parameterization, see Reestablish the parameterization on page 15. • Repairs required, contact ABB Service.
Red blinking 	Initialization phase of the device. (approx. 30 s after power-up of the power supply or after parameter changes)
Red slowly blinking 	Undervoltage. Check the supply power
Red quickly blinking 	EEPROM fault. Repairs required, contact ABB Service.

9 Maintenance / Repair

General

All measuring systems are calibrated using in-house calibration equipment. The device does not require any maintenance.

Occasional cleaning may be required where the air contains large amounts of dust or oil.

We recommend connecting an upstream air filter for this type of application.

Filters guaranteeing air quality in accordance with ISO 8573.1: Class 1-2 have proven especially useful here.

Cleaning

Cleaning the flowmeter sensor will only remove particles; sticky or stubborn stains cannot be removed.

If the sensor becomes contaminated with oil or deposits which cannot be blown out using air, the sensor needs to be returned to the manufacturer for cleaning in a special solution.

This will also involve a complete recalibration process.

NOTICE

Damage to the sensor

Damage to the sensor due to improper handling and cleaning. Under no circumstances should components like the honeycomb or sieve be removed from the flowmeter sensor, nor should they be bent or damaged in any other way.

- Any attempts to clean the sensor that go beyond the steps described above may cause destruction to the sensor.

Cleaning through blow-out:

1. Remove the connector of the connection cable from the sensor.
2. Make sure the pipeline is depressurized.
3. Remove the transmitter from the measuring section.
4. Carefully blow-out the sensor using clean pressurized air.
 - If the impurities cannot be removed, send the sensor to the manufacturer for cleaning and calibration.
5. Install the transmitter in the measuring section.
6. Reconnect the connection cable to the sensor.

Returning devices

Use the original packaging or a secure transport container of an appropriate type if you need to return the device for repair or recalibration purposes.

Fill out the return form (see **Return form** on page 31) and include this with the device.

In accordance with the EU Directive governing hazardous materials, the owner of hazardous waste is responsible for its disposal or must observe the following regulations for shipping purposes:

All devices delivered to ABB must be free from any hazardous materials (acids, alkalis, solvents, etc.).

Please contact Customer Center Service acc. to page 4 for nearest service location.

10 Dismounting and disposal

Dismounting

WARNING

Risk of injury due to process conditions.

The process conditions, for example high pressures and temperatures, toxic and aggressive measuring media, can give rise to hazards when dismantling the device.

- If necessary, wear suited personal protective equipment during disassembly.
- Before disassembly, make sure that the process conditions do not pose any safety risks.
- Depressurize and empty the device / piping, allow to cool and purge if necessary.

Bear the following points in mind when dismantling the device:

- Switch off the power supply.
- Disconnect electrical connections.
- Allow the device / piping to cool and depressurize and empty. Collect any escaping medium and dispose of it in accordance with environmental guidelines.
- Use suited tools to disassemble the device, taking the weight of the device into consideration.
- If the device is to be used at another location, the device should preferably be packaged in its original packing so that it cannot be damaged.
- Observe the notices in **Returning devices** on page 25.

Disposal

Note



Products that are marked with the adjacent symbol may **not** be disposed of as unsorted municipal waste (domestic waste).

They should be disposed of through separate collection of electric and electronic devices.

This product and its packaging are manufactured from materials that can be recycled by specialist recycling companies.

Bear the following points in mind when disposing of them:

- As of 8/15/2018, this product will be under the open scope of the WEEE Directive 2012/19/EU and relevant national laws (for example, ElektroG - Electrical Equipment Act - in Germany).
- The product must be supplied to a specialist recycling company. Do not use municipal waste collection points. These may be used for privately used products only in accordance with WEEE Directive 2012/19/EU.
- If there is no possibility to dispose of the old equipment properly, our Service can take care of its pick-up and disposal for a fee.

11 Accessories

Sensor

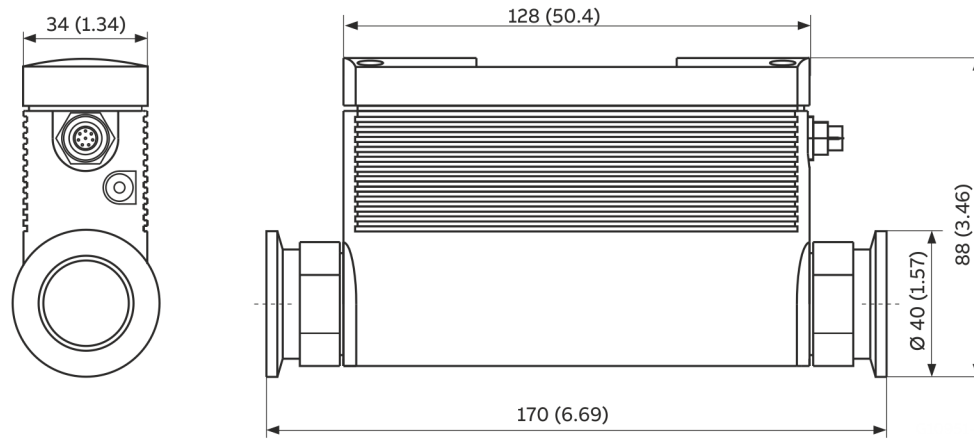
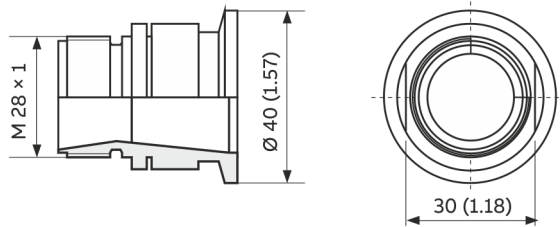

Figure 22: Flowmeter sensor FMT200-ECO2 with mounted small flange adapter

... 11 Accessories

Small flange connections

KF = ISO KF flange (ISO small flange)



Process connection KF DN 25, to adapt inlet run and outlet run, includes 2 clamp rings and 2 sealing rings

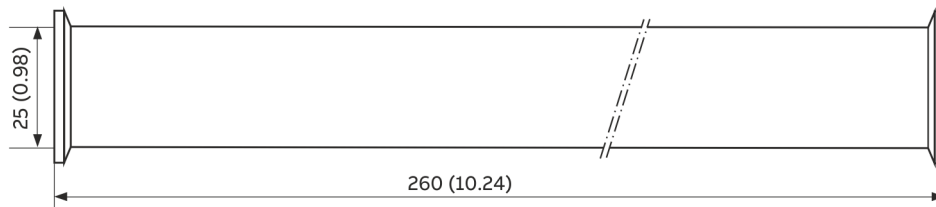

Inlet section 10 × D, both sides with KF DN 25 connection

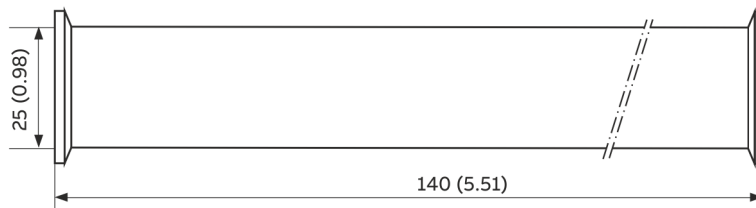

Outlet section 5 × D, both sides with KF DN 25 connection

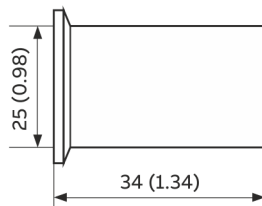

Hose adapter for KF DN 25, includes 1 small flange, as well as 1 clamping ring and 1 sealing ring each

Figure 23: Dimensions in mm (in)

Screwed connections and adapter

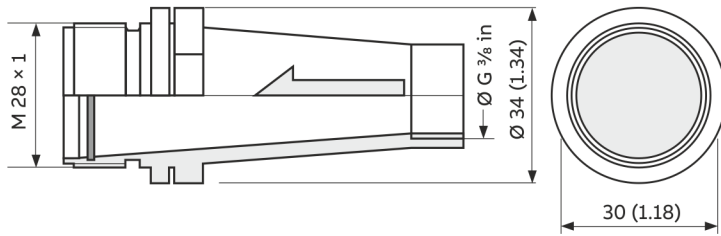

Screwed connection G $\frac{3}{8}$ in, connection for Legris hose adapter, pair) for inlet and outlet; inlet adapter with high-tech flow conditioner

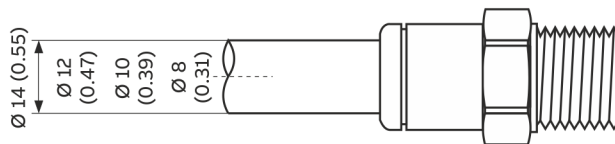

Legris hose adapter (pair)

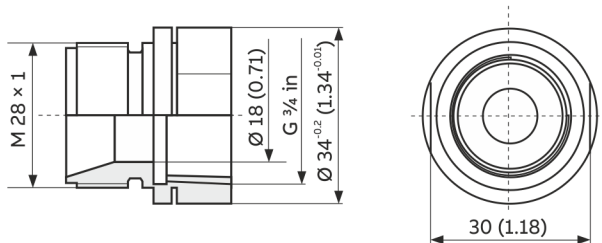

Screwed connection G $\frac{3}{4}$ in, simultaneous connection for Transair system 25 mm (pair)

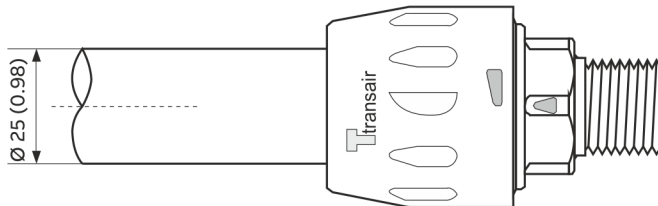

Transair adapter 25 mm (pair)

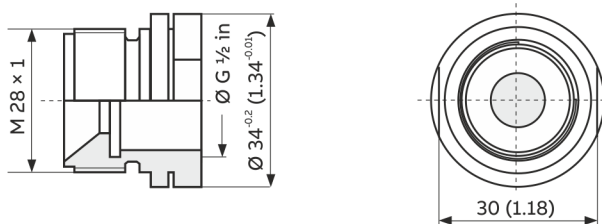

Screwed connection G $\frac{1}{2}$ in (pair) for inlet and outlet; inlet adapter with high-tech flow conditioner

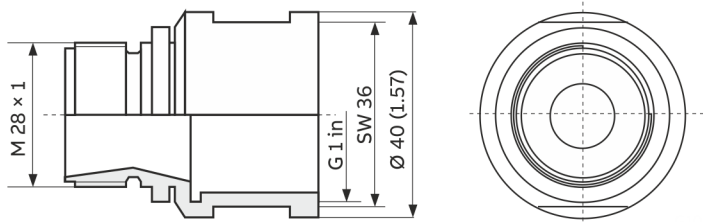

Screwed connection G 1 in

Figure 24: Dimensions in mm (in)

12 Specification

Note

The device data sheet is available in the ABB download area at www.abb.com/flow.

13 Additional documents

Note

All documentation, declarations of conformity, and certificates are available in ABB's download area. www.abb.com/flow

14 Appendix

Return form

Statement on the contamination of devices and components

Repair and/or maintenance work will only be performed on devices and components if a statement form has been completed and submitted.

Otherwise, the device/component returned may be rejected. This statement form may only be completed and signed by authorized specialist personnel employed by the operator.

Customer details:

Company:

Address:

Contact person:

Telephone:

Fax:

Email:

Device details:

Type:

Serial no.:

Reason for the return/description of the defect:

Was this device used in conjunction with substances which pose a threat or risk to health?

Yes No

If yes, which type of contamination (please place an X next to the applicable items):

biological

corrosive / irritating

combustible (highly / extremely combustible)

toxic

explosive

other toxic substances

radioactive

Which substances have come into contact with the device?

1.

2.

3.

We hereby state that the devices/components shipped have been cleaned and are free from any dangerous or poisonous substances.

Town/city, date

Signature and company stamp

ABB Measurement & Analytics

For your local ABB contact, visit:
www.abb.com/contacts

For more product information, visit:
www.abb.com/flow

We reserve the right to make technical changes or modify the contents of this document without prior notice. With regard to purchase orders, the agreed particulars shall prevail.
ABB does not accept any responsibility whatsoever for potential errors or possible lack of information in this document.

We reserve all rights in this document and in the subject matter and illustrations contained therein. Any reproduction, disclosure to third parties or utilization of its contents – in whole or in parts – is forbidden without prior written consent of ABB.