

Aztec ADS430

Optical dissolved oxygen probe



Measurement made easy

—
EPA-approved optical
dissolved oxygen
measurement

Introduction

The ADS430 (RDO® PRO-X) probe is a rugged, reliable instrument designed to deliver accurate dissolved oxygen (DO) data across a wide measurement range using the latest optical technology for DO measurement.

The probe is designed for use with the ABB AWT440 multi-input transmitter that features ‘hot-plugging’ capability. ‘Hot-plugging’ enables new or replacement sensors to be connected without the need to power down the transmitter.

When used in conjunction with the optional Aztec ADS430 EZCLEAN compressed air supply unit (connected to an ABB adaptor nozzle or flowcell), a schedule can be configured to provide automatic in-situ cleaning of the probe.

For more information

Further publications and publications for the associated Aztec AWT440 transmitter are available for free download from:

www.abb.com/measurement

or by scanning this code:



Search for or click on

Data Sheet Aztec ADS430 Optical dissolved oxygen probe	DS/ADS430-EN
Commissioning Instruction Aztec AWT440 Multi-input transmitter	CI/AWT440-EN
Operating Instruction Aztec AWT440 Multi-input transmitter	OI/AWT440-EN
Operating Instruction Aztec ADS430 EZCLEAN Compressed air supply unit	OI/ADS430/EZCLN-EN

Contents

1 Health & Safety	3
1.1 Document symbols	3
1.2 Safety precautions	3
1.3 Potential safety hazards	3
1.3.1 Aztec ADS430 probe – electrical	3
1.4 Safety standards	3
1.5 Product symbols	3
1.6 Product recycling and disposal (Europe only)	3
1.7 Restriction of Hazardous Substances (RoHS)	3
2 System overview	4
3 Installation	5
3.1 Siting	5
3.2 Probe dimensions	5
3.3 Storing the sensor cap	5
3.4 Fitting the sensor cap	5
3.5 Mounting / cleaning options	6
4 Sensor setup – first-time installation	7
5 Sensor setup	8
5.1 Sensor Setup	9
6 Calibration	11
6.1 Calibrate menu	11
6.2 1-Point calibration (water-saturated air)	12
6.3 2-Point calibration (100 % and 0 % saturation)	14
6.4 Abort calibration	16
6.5 Calibration timings	16
6.5.1 Stability period	16
6.5.2 Slow probe response	16
6.6 Calibration troubleshooting – slow sensor calibration or no response to dissolved oxygen changes	16
7 Maintenance	17
7.1 Cleaning the sensor cap	17
7.2 Cleaning the optical lens	17
7.3 Cleaning the probe body	17
7.4 Diagnostic messages	17
8 Specification	18
9 Spares and accessories	19
9.1 Spares	19
9.2 Accessories	19
Acknowledgements	19

1 Health & Safety

1.1 Document symbols

Symbols that appear in this document are explained below:

	<p>WARNING – Bodily injury</p> <p>This symbol in conjunction with the signal word 'WARNING' indicates a potentially dangerous situation. Failure to observe this safety information may result in death or severe injury.</p>
---	--

	<p>IMPORTANT (NOTE)</p> <p>This symbol indicates operator tips, particularly useful information or important information about the product or its further uses. The signal word 'IMPORTANT (NOTE)' does not indicate a dangerous or harmful situation.</p>
---	---

1.2 Safety precautions

Be sure to read, understand and follow the instructions contained within this manual before and during use of the equipment. Failure to do so could result in bodily harm or damage to the equipment.

	<p>WARNING – Bodily injury Installation, operation, maintenance and servicing must be performed:</p> <ul style="list-style-type: none"> – by suitably trained personnel only – in accordance with the information provided in this manual – in accordance with relevant local regulations
--	---

1.3 Potential safety hazards

1.3.1 Aztec ADS430 probe – electrical





The probe operates on 24 V DC supplied from the transmitter. There are no hazardous voltages present.

1.4 Safety standards

This product has been designed to satisfy the requirements of IEC61010-1:2010 3rd edition 'Safety Requirements for Electrical Equipment for Measurement, Control and Laboratory Use' and complies with US NEC 500, NIST and OSHA.

1.5 Product symbols

Symbols that may appear on this product are shown below:

	<p>Direct current supply only.</p>
	<p>This symbol identifies a risk of chemical harm and indicates that only individuals qualified and trained to work with chemicals should handle chemicals or perform maintenance on chemical delivery systems associated with the equipment.</p>
	<p>This symbol indicates the need for protective eye wear.</p>
	<p>This symbol indicates the need for protective hand wear.</p>
	<p>Recycle separately from general waste under the WEEE directive.</p>

1.6 Product recycling and disposal (Europe only)

	<p>Electrical equipment marked with this symbol may not be disposed of in European public disposal systems after 12 August 2005. To conform to European local and national regulations (EU Directive 2002/96/EC), European electrical equipment users must now return old or end-of-life equipment to the manufacturer for disposal at no charge to the user. ABB is committed to ensuring that the risk of any environmental damage or pollution caused by any of its products is minimized as far as possible.</p>
---	--

	<p>IMPORTANT (NOTE) For return for recycling, please contact the equipment manufacturer or supplier for instructions on how to return end-of-life equipment for proper disposal.</p>
---	---

1.7 Restriction of Hazardous Substances (RoHS)

	<p>The European Union RoHS Directive and subsequent regulations introduced in member states and other countries limits the use of six hazardous substances used in the manufacturing of electrical and electronic equipment. Currently, monitoring and control monitors do not fall within the scope of the RoHS Directive, however ABB has taken the decision to adopt the recommendations in the Directive as the target for all future product design and component purchasing.</p>
---	--

2 System overview

ADS430 probe components are shown in Fig. 2.1:

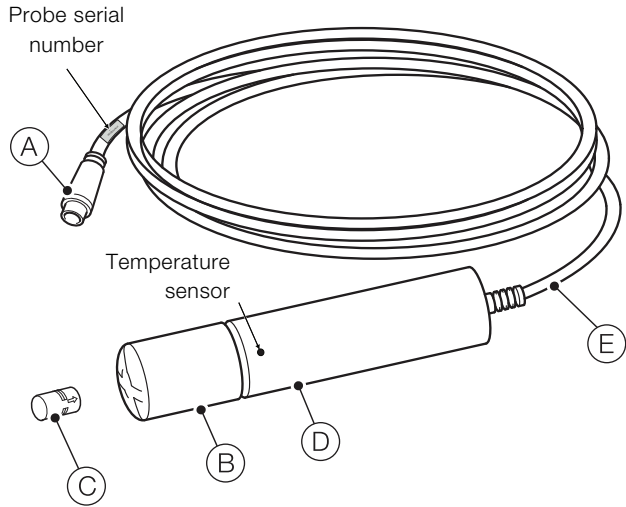

Item	Feature
(A)	EZLink digital sensor connector
(B)	Shroud
(C)	Sensor cap (supplied unfitted in sealed factory-supplied container) Note. the sensor cap serial number is programmed on the memory chip inside the cap.
(D)	Probe body (including temperature sensor)
(E)	10 m (39.3 ft.) fixed cable Note. The probe serial number is printed on a label at the plug end of the fixed cable. For extension cables (including twist-lock connector) – see Section 9.2, page 19.
(F)	Calibration chamber
(G)	Calibration chamber storage cap
(H)	Calibration chamber vented calibration cap
(I)	Sponge wafer

Table 2.1 Probe – component descriptions

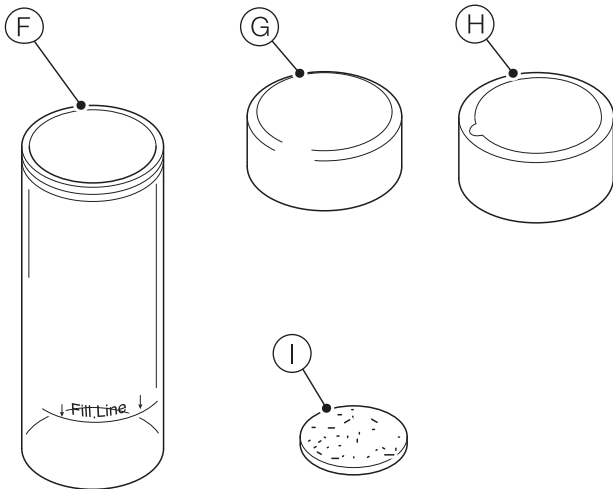

Fig. 2.1 ADS430 probe components

3 Installation

3.1 Siting

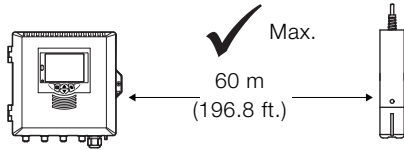

Fig. 3.1 Siting the sensor

3.2 Probe dimensions

Dimensions in mm (in.).

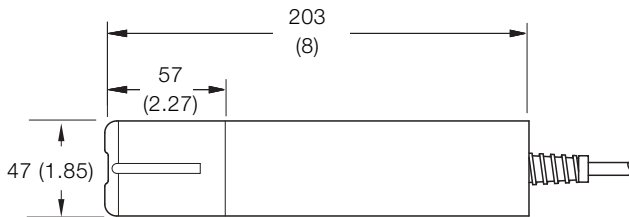

Fig. 3.2 Probe dimensions

3.3 Storing the sensor cap

i IMPORTANT (NOTE) Prior to installation, the sensor cap (see Fig. 2.1, page 4) must remain stored in the sealed factory-supplied sleeve.

3.4 Fitting the sensor cap

1. Remove the probe assembly from the box.

Referring to Fig. 3.3:

2. Unscrew shroud (A) from probe body (B) and remove dust cover (C) from probe tip (D).

Retain the dust cover for later use.

3. Remove sensor cap (E) from its sealed storage sleeve.

i IMPORTANT (NOTE)

- Do not allow moisture or atmospheric humidity inside sensor cap (E). Keep it in the sealed sleeve until it is ready to be installed. Ensure the 2 O-ring grooves on the probe are dry and O-rings (F) are not rolled or pinched when the cap is fitted.
- The sensor cap lifetime is 2-years after the first reading has been taken. Install by the date printed on the package.

4. Align arrow (G) on sensor cap (E) with index mark (H) on the probe.

i IMPORTANT (NOTE) When fitting the sensor cap, DO NOT touch the cap end.

5. Slide sensor cap (E) over probe tip (D) firmly until it seals over O-rings (F) – do not twist the cap.
6. Refit shroud (A) by screwing it onto probe body (B). Ensure O-ring is fitted.

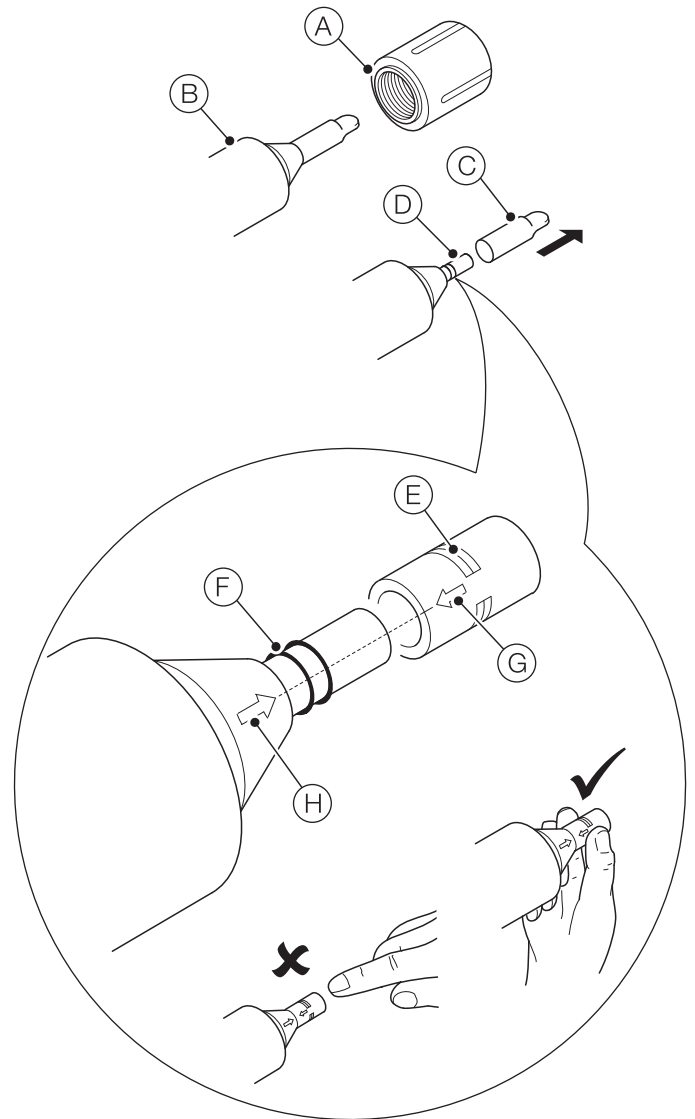
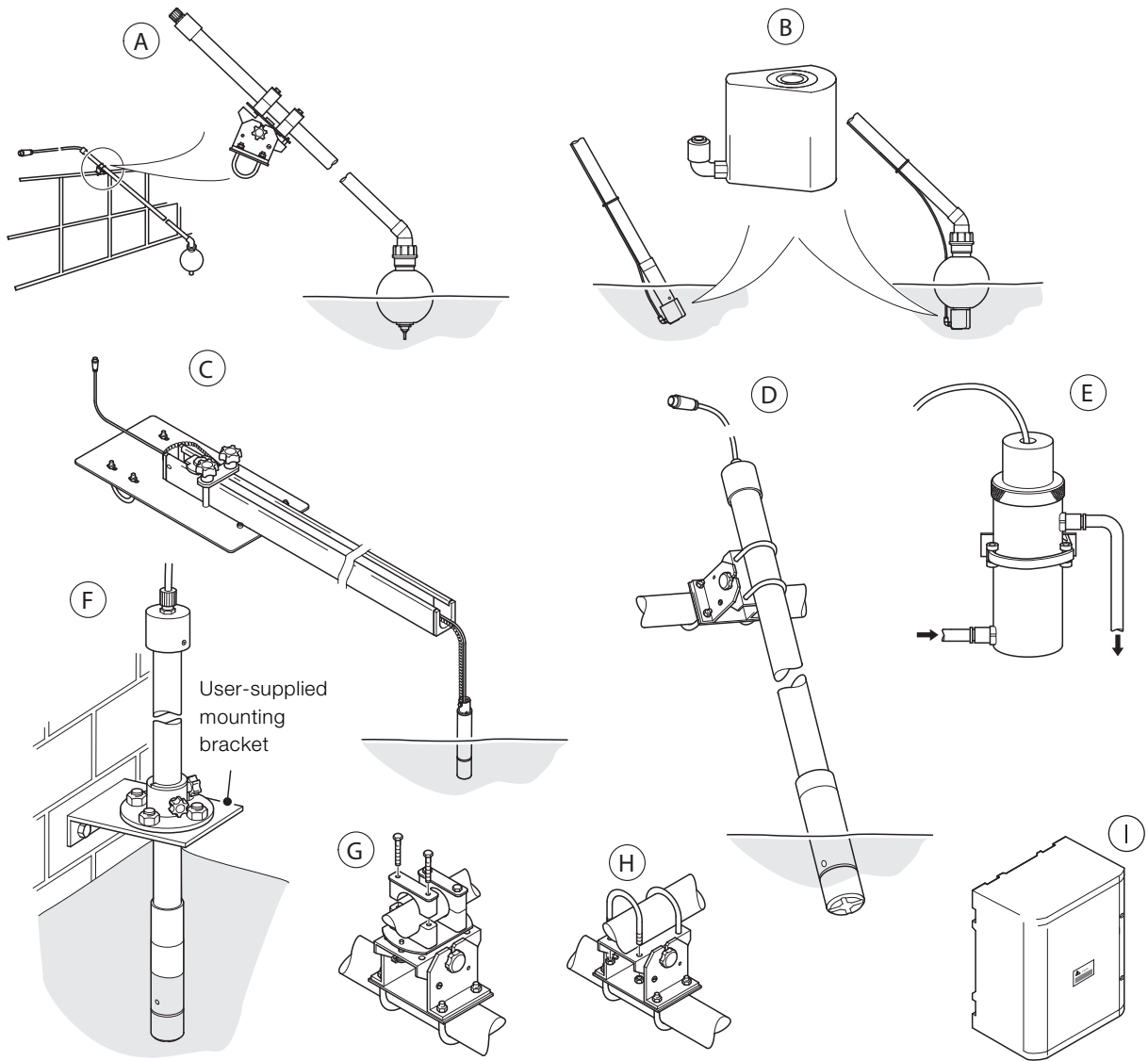

Fig. 3.3 Fitting the sensor cap

3.5 Mounting / cleaning options

Probe mounting / cleaning options are shown in Table. 3.1:



Item	Mounting option	Item	Mounting option
(A)	Floating ball assembly: ADS430110 (including boom) or floating ball assembly kit: ADS430120 (excluding boom) — suitable for handrail mounting using swivel / tilt bracket (item (G)) or tilt bracket (Item (H))	(E)	Flowcell pipeline mount: ADS430160 — suitable for wall (surface) mounting (includes wall mounting clip)
(B)	Air cleaning system: ADS430170 — shown fitted to dip pole and floating ball assembly	(F)	Open tank flanged dip mount: ADS430150 — for mounting on user-supplied mounting bracket
(C)	Open channel and open tank mounting kit: ADS430140 — suitable for floor / wall (surface) mounting	(G)	Handrail mounting bracket – swivel / tilt action: — ADS430130: for 42 (1.7 in.) handrail and 48 mm (1.89 in.) diameter boom — ADS430135: for 50 mm (1.97 in.) handrail and 50 mm (1.97 in.) diameter boom
(D)	Dip / Pole assembly: ADS430100 (including dip pole) or pole mounting adaptor kit: ADS430105 (excluding dip pole) — handrail-mounted using tilt bracket (Item (H))	(H)	Handrail mounting bracket – tilt (standard): — ADS430125: for 42 mm (1.7 in.) handrail and 48 or 50 mm (1.89 in. or 2.0 in.) diameter boom — ADS430128: for 50 mm (2.0 in.) handrail and 48 or 50 mm (1.89 in. or 2.0 in.) diameter boom
		(I)	EZClean compressor unit: — ADS430050: 230 V AC — ADS430051: 115 V AC

Table 3.1 Probe mounting / cleaning options

4 Sensor setup – first-time installation

i IMPORTANT (NOTE)



Perform this procedure when a new / replacement sensor cap is connected to the transmitter for the first time only. For existing sensors, see Section 5, page 8.

To perform a first-time installation (*Easy Setup* menu):

1. Connect a new or replacement probe to the transmitter's EZLink connector – see transmitter Operating instructions OI/AWT440-EN.

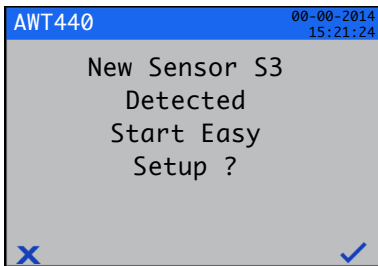
The *New Sensor S(1 – 4) Detected Start Easy Setup ?* prompt is displayed identifying the new / replacement sensor (S1 to S4):



2. To enter *Easy Setup* level, press the  key (below the  icon).

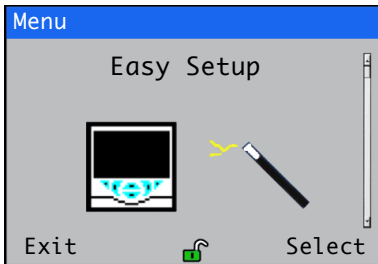

The *Easy Setup* start screen is displayed:



Press the  key (below the *Select* prompt).

3. To enter *Easy Setup* level, press the  key (below the *Select* icon).

The *Configuration* parameter is displayed on the left of the screen and the factory default value for it is displayed on the right.

4. Press the  key (below the *Edit* prompt) to change the default value to the required value / selection.
5. Press the  key (below the *Next* prompt) to accept the value / selection displayed and advance to the next configuration parameter.

The following *Configuration* parameters are set at *Easy Setup* level:

- Tag
- PV Type
- Units
- Range High
- Range Low
- Clean Interval
- Salinity Units
- Salinity Correction
- Pressure Units
- Barometric Pressure

i IMPORTANT (NOTE)

Refer to Section 5.1, page 9, for parameter details – not all parameters in Section 5.1 are displayed at *Easy Setup* level.

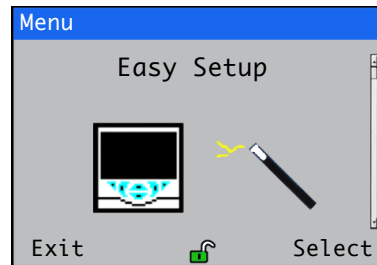

6. Continue with configuration of the required parameters.

On completion the *Easy Setup* start screen is displayed:



7. To exit *Easy Setup*, press the  key (below the *Exit* prompt) to display the *Operator Page*.

Pressing the  key (below the *Select* prompt) re-enters the *Easy Setup* level where parameters can be reviewed or modified after 1st time connection.

After completing the *Easy Setup* level, pressing the  or  key enters the *Advanced Configuration* level, where all available sensor and transmitter parameters can be reviewed or modified.

i IMPORTANT (NOTE)

To re-configure an existing probe (after first-time installation), enter the *Configuration* level (see Section 5.1, page 9) via the *Operator Page* – refer to transmitter Operating instructions OI/AWT440-EN for *Operator Page* details and navigation.



8. When the probe has been configured, perform a *Calibrate* routine – see Section 6, page 11.



5 Sensor setup

i IMPORTANT (NOTE)

Perform this procedure on existing probe(s) only. Probes are setup / configured individually. If installing a new / replacement probe, see Section 4, page 7.

1. Connect the ADS430 probe to the transmitter's EZLink connector – see transmitter Operating instructions OI/AWT440-EN.
2. At the AWT440 transmitter, press the  key to display the *Operator Page* menu, then select *Enter Configuration* to display the *Access Level* page.

Use the  key to select the *Advanced* menu item and press the  key (below the *Select* prompt).

If the *Sensor Setup* menu is not displayed use the  /  keys to scroll to it:

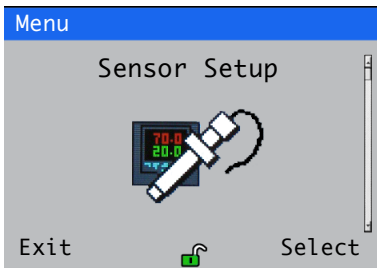

Press the  key (below the *Select* prompt).

The *Sensor Setup* page is displayed:

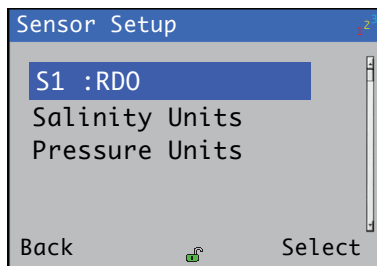

3. Ensure *S1 :RDO* is highlighted and press the  key (below the *Select* prompt).

The *S1 :RDO* menu page is displayed:

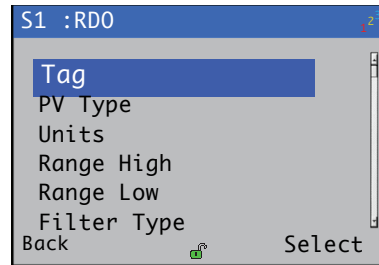

4. Proceed with sensor setup – see Section 6.1, page 11 for parameter options.

5.1 Sensor Setup

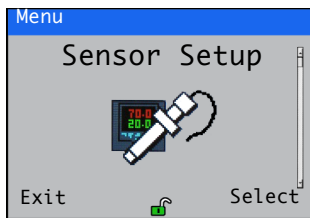

Used to set the tag, measurement units, operational range and clean functions and to compensate for salinity and barometric pressure.

Menu	Comment	Default
S1 (to 4) :RDO	Select the optical dissolved oxygen probe to set up.	
Tag	Enter an alphanumeric probe tag (16 characters maximum) to identify the probe on the <i>Operator Pages</i> .	
PV Type	Select measurement type. Note. If a change is made the I/O sources are reset. <i>DO Concentration / % Saturation</i>	DO Concentration
Units	Select the measurement units: <i>mg/l / ppm</i>	ppm
Range High	Set the span value in <i>Chart</i> and <i>Bargraph</i> views.	50 ppm (200 %)
Range Low	Set the zero value in <i>Chart</i> and <i>Bargraph</i> views.	0
Filter Type	Select the filter type: <i>Off / Low / Medium / High</i>	Off
Clean Interval	Set the interval between cleans: <i>Off / 15 Mins. / 30 Mins. / 45 Mins. / 1 to 24 Hours</i>	Off
Clean Type *	Set the clean type: <i>Continuous / Pulsed</i>	Continuous
Clean On Time *	Set the duration of the clean: <i>1 to 60 Secs</i>	30 Secs
Clean Off Time * †	Set the duration between cleans: <i>1 to 60 Secs</i>	30 Secs
Number of Pulses * †	Set the number of cleaning pulses: <i>1 to 10 Pulses</i>	2 Pulses
Recovery Time *	Set the time delay between the completion of cleaning and the display of a new reading on the operator page: <i>1 to 10 Min.</i>	1 Min.
Clean Duration *	Displays the total duration of the clean: Clean Type set to <i>Continuous</i> = Clean on Time + Recovery Time Clean Type set to <i>Pulsed</i> = (Clean on Time + Clean Off Time) x Number of Pulses + Recovery Time	
Clean Output *	Displays the output signal the clean is assigned to. This can be set to relay 1 to 6 or digital output 1 to 6 – refer to OI/AWT440-EN.	No Assignment

* Displayed only if **Clean Interval** is **NOT** set to *Off*

† Displayed only if **Clean Type** is set to *Pulsed*

Continued on next page...

Menu	Comment	Default
Salinity Correction	Required when monitoring water containing high quantities of dissolved salts. Enter the required value between 0 and 42 Practical Salinity Units (PSU). Leave at the default value of 0 PSU if salinity correction is not required.	0 PSU
Barometric Pressure	Barometric pressure compensation. Set the local barometric pressure to 506 – 1114 mbar (380 – 835 mm/Hg). If the barometric pressure is unknown, leave at the default sea-level value of 1013 mbar (760 mm/Hg).	1013 mbar
Restore Defaults	Select to reset all <i>Sensor Setup</i> parameters to their default values.	
Salinity Units	Select the required salinity units: <i>PSU</i> (Practical Salinity Units) or <i>ppt</i> (parts-per-thousand)	PSU
Pressure Units	Select the required barometric pressure units: <i>mBar</i> / <i>mmHg</i>	mBar

6 Calibration

This section describes how to calibrate the probe and involves measuring the probe's sensitivity to oxygen by exposing the probe to water-saturated air.

Calibrations are initiated via the *Cal* prompt displayed on Operator pages or via the *Calibrate* and *Advanced* menu items on the *Access Level* page – refer to transmitter Operating instructions OI/AWT440-EN for all transmitter menu options.

i IMPORTANT (NOTE)

- Do not perform a calibration until the probe and transmitter are installed and ready for operation.
- Before removing the probe for calibration purposes, set the currents outputs and alarms to *Hold* (enabled via the *Operator Menu / Manual Hold* function).
- After calibration and probe replacement, reset the currents outputs and alarms – see Section 6.1 below.

6.1 Calibrate menu

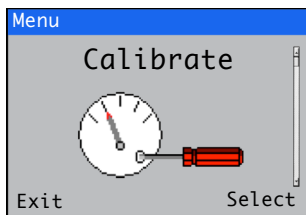

Used to calibrate the probe.

Access to the *Calibrate* menu is permitted via the *Calibrate* and *Advanced* levels only.

Note. During calibration, current outputs and alarms are set to *Hold* automatically if *Hold Outputs* is enabled (see below).

Menu	Comment	Default
S1(to 4) :RDO	Select the optical dissolved oxygen probe to calibrate.	
Probe Calibration		
Calibration Type		
1-Point Cal	Select to perform a 1-point calibration in water-saturated air (100% saturation).	
2-Point Cal	Select to perform a 100% saturation calibration in water-saturated air and a 0% saturation calibration in an oxygen-depleted solution, e.g. sodium sulphite (Na ₂ SO ₃).	
Hold Outputs	Enable / disable the <i>Hold Outputs</i> function. If enabled, the current outputs and alarm functions are held during calibrations.	Enabled

6.2 1-Point calibration (water-saturated air)

Referring to Fig. 6.1:

1. Remove storage cap (A) from the top of calibration chamber (B).
2. Place sponge wafer (C) in the bottom of calibration chamber (B) and saturate with approximately 10 ml (0.34 fl oz [US]) of water.
3. Fit vented calibration cap (D) to the top of calibration chamber (B).
4. Ensure the probe and sensing element are completely dry. If necessary use a paper towel to remove any water or debris from the probe or sensing element.
5. Slide probe (E) into calibration chamber (B) until the sensing element is approximately 25 mm (1 in.) above water-saturated sponge (C).
6. Allow 5 to 10 minutes for temperature stabilization prior to continuing the calibration procedure from step 7 onwards.

i IMPORTANT (NOTE)

- Do not leave the probe in the calibration chamber for more than 30 minutes – this can allow condensation to form on the surface of the sensing element, producing false low readings after calibration.
- If condensation occurs, remove the probe, thoroughly dry the sensing element, probe and thermistor before performing the calibration procedure.

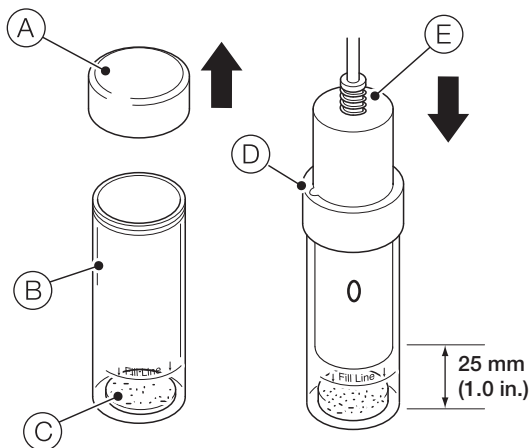
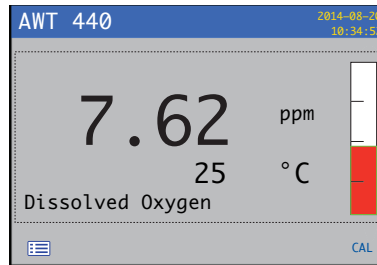
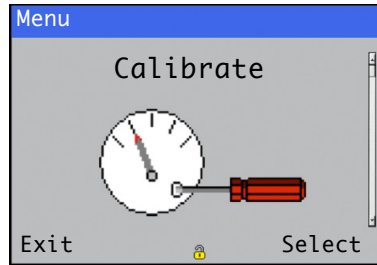

Fig. 6.1 1-Point calibration

7. At the transmitter perform a 1-point calibration from an *Operator* page as follows:
8. Press the key (below the *Cal* prompt).



The *Calibrate* page is displayed:



9. Press the key (below the *Select* prompt).

The *Calibrate* page is displayed with all available sensors shown:

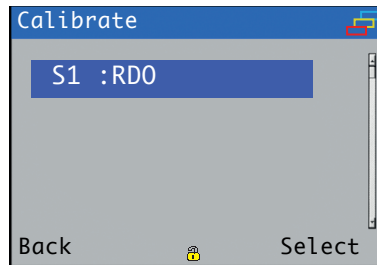

10. Use the / keys to select the probe to be calibrated and press the key (below the *Select* prompt).

The *Calibration Type* page is displayed:

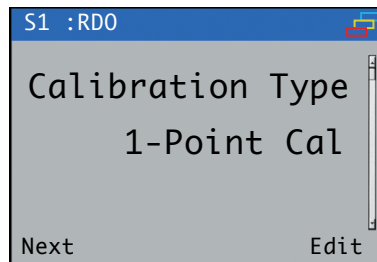



11. If *1-Point Cal* is displayed, go to step 14.

If *1-Point Cal* is not displayed, press the  key (below the *Edit* prompt).

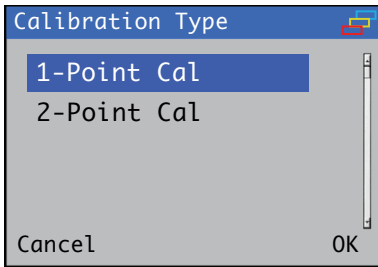
The *Calibration Type* selection page is displayed:



12. Use the  /  keys to select *1-Point Cal* and press the  key (below the *OK* prompt).

The *Calibration Type* page is displayed:

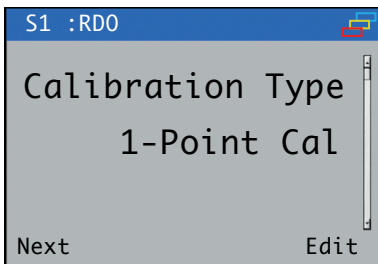

13. Press the  key below the *Next* prompt).

The *Calibrate / Start Span Cal?* page is displayed:

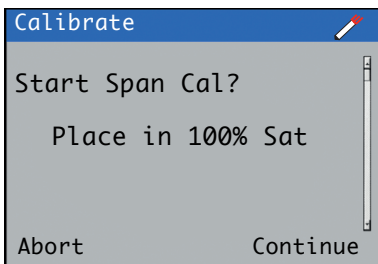

14. Press the  key (below the *Continue* prompt).

The *Calibrate* page is displayed:

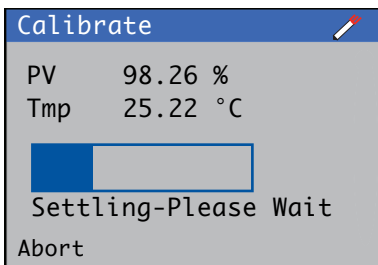

15. When span calibration is complete, a results page is displayed:

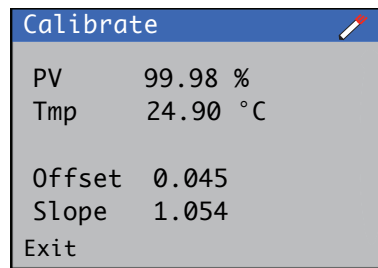

In the event of a calibration failure, the message *Calibration Failed* is displayed with an indication of the reason for failure, for example '*Result Out Of Bounds*'.

16. Press the  key (below the *Exit* prompt).

The *Calibrate* page is displayed:

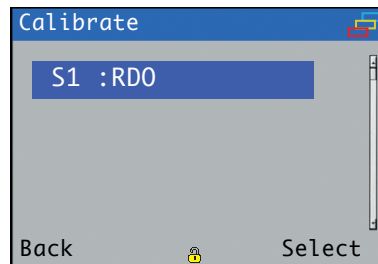

17. Press the  key (below the *Back* prompt).

The *Calibrate* page is displayed:

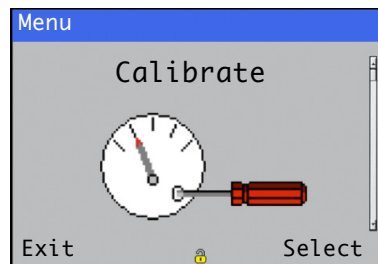

18. Press the  key (below the *Exit* prompt) to return to the *Operator* page.

6.3 2-Point calibration (100 % and 0 % saturation)

i IMPORTANT (NOTE) This calibration procedure requires 60 ml (2.0 fl oz [US]) of fresh sodium sulphite solution.

1. Perform a 1-point calibration.

Referring to Fig. 6.2:

2. Remove storage cap (A) from the top of calibration chamber (B).
3. Place sponge wafer (C) in the bottom of calibration chamber (B) and saturate with approximately 10 ml (0.34 fl oz [US]) of water.
4. Fit vented calibration cap (D) to the top of calibration chamber (B).
5. Ensure the probe and sensing element are completely dry. If necessary use a paper towel to remove any water or debris from the probe or sensing element.
6. Slide probe (E) into calibration chamber (B) until the sensing element is approximately 25 mm (1 in.) above water-saturated sponge (C).
7. Allow 5 to 10 minutes for temperature stabilization prior to continuing the calibration procedure from step 8 onwards.

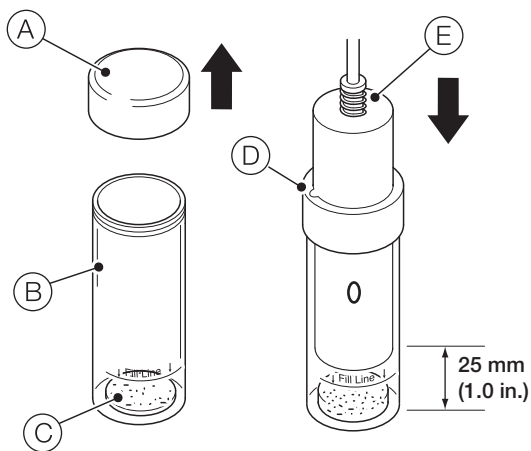
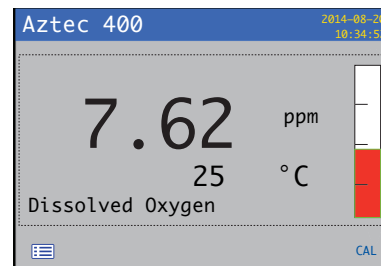

Fig. 6.2 1-Point calibration

i IMPORTANT (NOTE)

- Do not leave the probe in the calibration chamber for more than 30 minutes – this can allow condensation to form on the surface of the sensing element, producing false low readings after calibration.
- If condensation occurs, remove the probe, thoroughly dry the sensing element, probe and thermistor before performing the calibration procedure.

8. At the transmitter perform a 2-point calibration from an *Operator* page as follows:
9. Press the key (below the *Cal* prompt).



The *Calibrate* page is displayed:

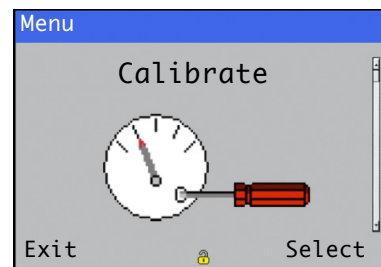

10. Press the key (below the *Select* prompt).

The *Calibrate* page is displayed with all available sensors shown:

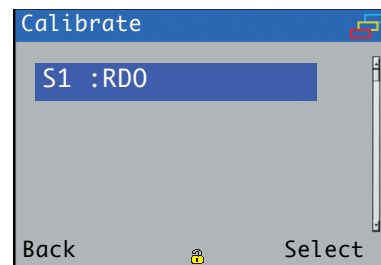

- Use the \triangle / ∇ keys to select the probe to be calibrated and press the \checkmark key (below the *Select* prompt).

The *Calibration Type* page is displayed:

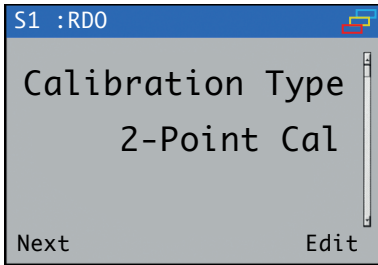

- If *2-Point Cal* is displayed, go to step 14.

If *2-Point Cal* is not displayed, press the \checkmark key (below the *Edit* prompt).

The *Calibration Type* selection page is displayed:

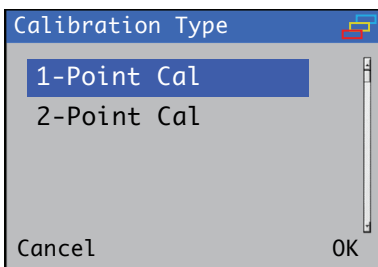

- Use the \triangle / ∇ keys to select *2-Point Cal* and press the \checkmark key (below the *OK* prompt).

The *Calibration Type* page is displayed:

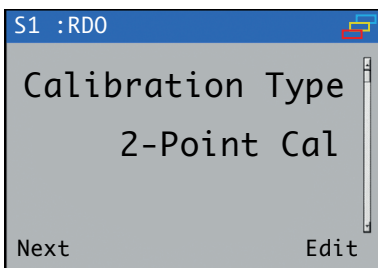

- Press the ∇ key below the *Next* prompt).

The *Calibrate / Start Span Cal?* page is displayed:

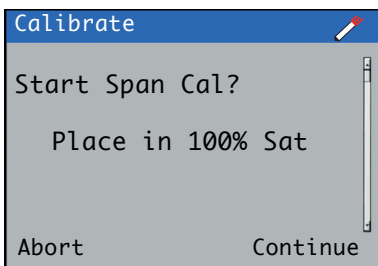

- Press the \checkmark key (below the *Continue* prompt).

The *Calibrate* page is displayed:

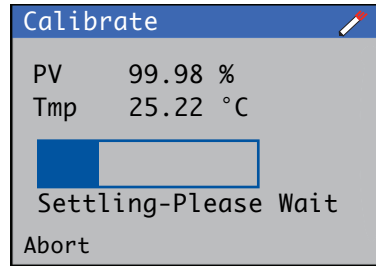

- When span calibration is complete, the *Calibrate / Start Zero Cal?* page is displayed:

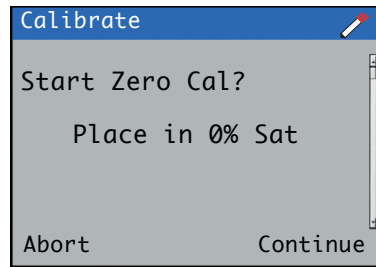

Referring to Fig. 6.3:

- Remove sponge wafer (A) from the bottom of calibration chamber (B) (ensure vented calibration cap (C) is in place at the top of the chamber).
- Fill calibration chamber (B) to fill line (D) using 60 ml (2.0 fl oz [US]) of fresh sodium sulphite solution.
- Slide probe (E) into the chamber leaving at least 13 mm (0.5 in.) between the surface of the sensing element and the bottom of the chamber – ensure the temperature sensor (F) is completely submerged in the solution.
- Allow 5 to 10 minutes for temperature stabilization prior to continuing the calibration procedure from step 21 onwards.

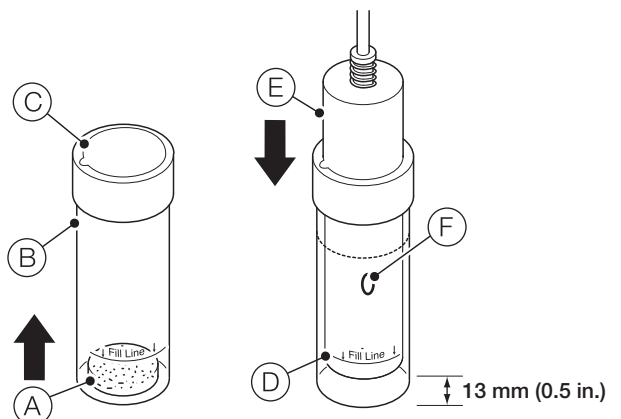
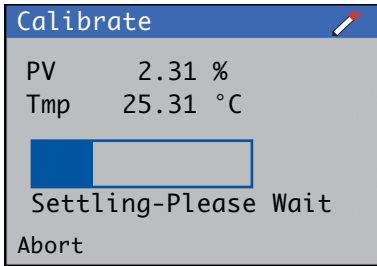

Fig. 6.3 2-Point calibration

21. Press the  key (below the *Continue* prompt).

The *Calibrate* page is displayed:



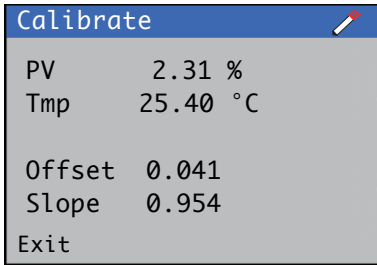

22. When zero calibration is complete, a results page is displayed:

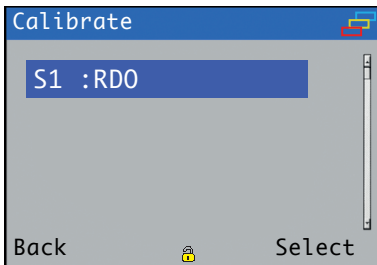

23. Press the  key (below the *Exit* prompt).

The *Calibrate* page is displayed:



24. Press the  key (below the *Back* prompt).

The *Calibrate* page is displayed:

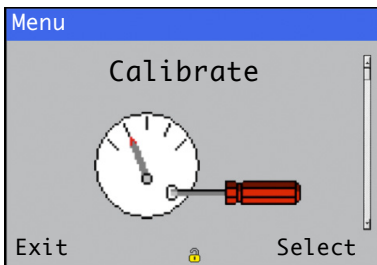

25. Press the  key (below the *Exit* prompt) to return to the *Operator* page.

26. Once the calibration is complete, remove the sensor from the chamber and rinse thoroughly to remove all of the sodium sulphite.

6.4 Abort calibration

A calibration is aborted by pressing the  key below the *Abort* prompt displayed on the *Calibrate* pages (refer to transmitter Operating instructions OI/AWT440-EN). The *Calibration Log* displays the message *Cal Aborted* – refer to OI/AWT440-EN for *Calibration Log* entries.

6.5 Calibration timings

6.5.1 Stability period

The temperature and concentration readings are monitored for up to 10 minutes until a stable reading is achieved. When stability is achieved, the calibration (slope and offset) values are determined.

6.5.2 Slow probe response

If the output from the probe does not stabilize during the Stability Period the calibration is not accepted and a *Cal Failed* diagnostic is displayed, the *Calibration Log* is updated with a *Cal Failed* message.

6.6 Calibration troubleshooting – slow sensor calibration or no response to dissolved oxygen changes

1. Check probe configuration / recalibrate probe – refer to Section 6, page 11.

If the fault persists:

2. Clean the sensor cap and lens – refer to Section 7, page 17.

If the fault persists:

3. Replace the sensor cap – refer to Section 9, page 19.

If the fault persists:

4. Replace the probe.

7 Maintenance

7.1 Cleaning the sensor cap

1. Isolate the transmitter and remove the probe from the process.

Referring to Fig. 7.1:

2. Unscrew shroud (A) from probe body (B).
3. Rinse sensor cap (C) with clean water from a spray bottle.
4. Gently wipe sensor cap (C) with a soft-bristled brush or, if biofouling is present, a soft cloth.
If necessary, use a grease remover to remove grease.
5. Refit shroud (A) by screwing it onto probe body (B).

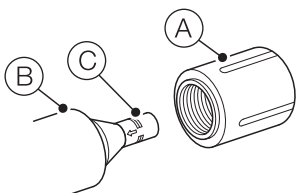

Fig. 7.1 Cleaning the sensor cap

7.2 Cleaning the optical lens

1. Isolate the transmitter and remove the probe from the process.

Referring to Fig. 7.2:

2. Unscrew shroud (A) from probe body (B).
3. Grip sensor cap (C) between your thumb and forefinger and carefully slide it off of probe sensor (D).



IMPORTANT (NOTE)

- DO NOT touch the cap end of sensor cap (C).
- Do not allow moisture or atmospheric humidity inside sensor cap (C).
- Do not wet lens area (E) with water or any solution. Use only the supplied lens cloth for cleaning.

4. Gently wipe optical lens (E) with a lens cloth (not supplied).
5. Refit shroud (A) by screwing it securely onto probe body (B).

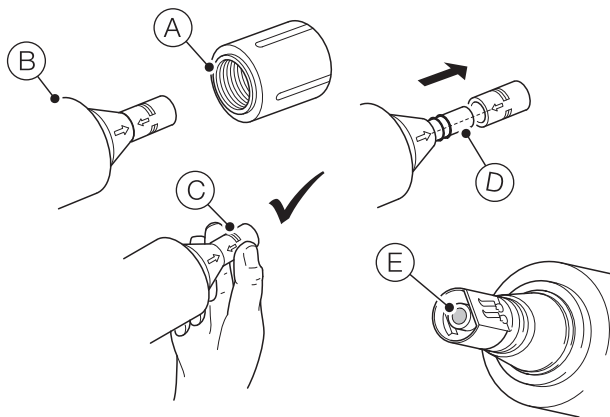

Fig. 7.2 Cleaning the optical lens

7.3 Cleaning the probe body

1. Isolate the transmitter and remove the probe from the process.

Referring to Fig. 7.3:



IMPORTANT (NOTE)

- Ensure shroud (A) is secured in place before cleaning.

2. Gently scrub shroud (A) and probe body (B) with a soft-bristled brush or nylon dish scrubber.
If necessary, use a grease remover to remove grease or other matter from the body, or soak in vinegar and deionized water to remove mineral deposits or extensive fouling.

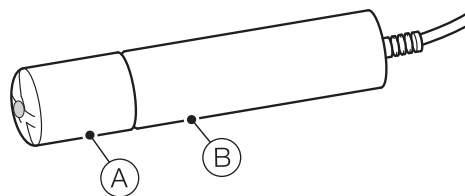

Fig. 7.3 Cleaning the probe body

7.4 Diagnostic messages

The table below shows sensor-specific icon types, diagnostic messages and possible causes / suggested remedial action.



IMPORTANT (NOTE)

- The diagnostic icons in the following tables conform to NAMUR 107.
- For transmitter-specific diagnostics messages, refer to AWT440-EN.

Diagnostic Icon	NAMUR Status
	Out of specification
	Maintenance required
	Check function

Icon	Message	Possible cause / suggested action
	Cap Expired (S1, S2, S3, S4)	The optical DO sensor cap has reached or exceeded its expiry date. The cap may continue operating but its accuracy will degrade and cannot be guaranteed to meet specification.
	Replace Cap	The optical DO sensor cap will reach expiry date in 4 weeks or less. Replace sensor cap.
	Cap Removed	The sensor cap has been removed. The reading will drop to zero. Ensure sensor cap is fitted onto the probe tip.

8 Specification

Sensor type

Optical (luminescent) dissolved oxygen sensor

Probe

IP rating

IP68

Range

0 to 50 mg/l concentration; 0 to 600 % saturation

Accuracy

±0.1 mg/l, 0 to 8 mg/l

±0.2 mg/l, 8 to 20 mg/l

±10 % of reading, 20 to 50 mg/l

Resolution

0.01 mg/l

Response time

T90 < 45 sec; T95 < 60 sec @ 25 °C (77 °F)

Storage conditions

-5 to 60 °C (23 to 140° F)

Dimensions

47 mm (1.85 in.) diameter

203 mm (8 in.) length

Probe internal mounting thread

1 1/4 NPT

Sensor cap

Typical working life

2 years

IP rating

IP68 (when fitted)

Storage conditions

1 to 60 °C (33° to 140° F) in factory container

Temperature sensor

Operating temperature range

0 to 50 °C (32 to 122° F)

Accuracy

±0.1 °C typical

Resolution

±0.01 °C

Power

Consumption (maximum)

50 mA @ 12 V DC

Measurement current

6 mA typical @ 24 V DC

Idle current (no measurement or consumption)

160 µA typical @ 24 V DC

Cable

Fixed length

10 m (32.8 ft.)

EZLink digital sensor connector IP rating

IP67 (when connected)

Extension cable (options)

1, 5, 10, 15, 25, 50 m (3.2, 16.4, 32, 49.2, 82, 164 ft.)

Maximum length (including optional extension cable)

Up to 60 m (196.8 ft.)

Salinity compensation

0 to 42 PSU (ppt)

Barometric pressure

506 to 1114 mbar (380 to 835 mm/Hg)

Environmental ratings

Pressure

10.342 bar (150 psi) from 0 to 50 °C (32 to 122 °F),

20.468 bar (300 psi) @ 25 °C (77 °F)

Operating temperature range

0 to 50 °C (32 to 122 °F)

Compliance

Heavy industrial, IEC:61000-6-2:2005

Methods

Standard methods 4S00-0

In-Situ methods 1002-8-2009, 1003-8-2009,

1004-8-2009 (EPA approved)

Materials of construction

Sensor cap

PC / PMMA

Probe body

ABS

Temperature sensor

Titanium

Cable

Polyurethane

DS/ADS430-EN Rev. E

i IMPORTANT (NOTE) There are some known interferents such as: alcohols > 5 %; hydrogen peroxide > 3 %; sodium hypochlorite (commercial bleach) > 3 %; gaseous sulfur dioxide; gaseous chlorine. Organic solvents and certain petroleum-based hydrocarbons may swell the sensing element and destroy it. Examples include, but are not limited to, acetone; chloroform; methylene chloride and BTEX (benzene, toluene, ethylbenzene, xylene) compounds.

9 Spares and accessories

9.1 Spares

Part number	Description
ADS430203	ABB RDO probe O-ring replacement kit
ADS430204	ABB RDO probe sensor cap replacement kit
ADS430205	ABB RDO probe calibration kit
ADS430212	Nose replacement kit
AWT4009010	1 m (3.2 ft.) extension cable
AWT4009050	5 m (16.4 ft.) extension cable
AWT4009100	10 m (32 ft.) extension cable
AWT4009150	15 m (49.2 ft.) extension cable
AWT4009250	25 m (82 ft.) extension cable
AWT4009500	50 m (164 ft.) extension cable

Table 9.1 Spares

9.2 Accessories

Part number	Description
ADS430125*	Handrail mounting bracket for 42 mm (1.7 in.) dia handrail – dip or floating ball systems
ADS430128*	Handrail mounting bracket for 50 mm (2.0 in.) dia handrail – dip or floating ball systems
ADS430130*	Swivel and tilt action handrail mounting bracket for 42 mm (1.7 in.) dia. handrail – floating ball systems only
ADS430135*	Swivel and tilt action handrail mounting bracket for 50 mm (2.0 in.) dia. handrail – floating ball systems only
ADS430145	ADS430 chain mounting adaptor with 3 m (9.8 ft.) chain
ADS430144	Stainless steel chain (extension) – 10 m (32.8 ft.)
ADS430050*	EZCLEAN compressor unit: – 230 V AC
ADS430051*	– 115 V AC
ADS430057	EZCLEAN upgrade kit; includes EZCLEAN compressor unit, air-blast adaptor assembly, pneumatic tubing, spring clips for dip pole and floating ball boom: – 230 V AC
ADS430058	– 115 V AC

Table 9.2 Accessories

*See Section 3.5, page 6.

Acknowledgements

RDO is a registered copyright of In-Situ Inc.



Sales



Service

ABB Limited**Measurement & Analytics**

Howard Road, St. Neots
Cambridgeshire,
PE19 8EU
UK

Tel: +44 (0)870 600 6122

Fax: +44 (0)1480 213 339

Email: enquiries.mp.uk@gb.abb.com

ABB Inc.**Measurement & Analytics**

125 E County Line Road
Warminster, PA 18974
USA

Tel: +1 215 674 6000

Fax: +1 215 674 7183

abb.com/measurement



We reserve the right to make technical changes or modify the contents of this document without prior notice. With regard to purchase orders, the agreed particulars shall prevail. ABB does not accept any responsibility whatsoever for potential errors or possible lack of information in this document.

We reserve all rights in this document and in the subject matter and illustrations contained therein. Any reproduction, disclosure to third parties or utilization of its contents – in whole or in parts – is forbidden without prior written consent of ABB.