

2104517 Rev. AD

μ FLO^{G4} (microFLO^{G4}) Flow Computer

User's Manual

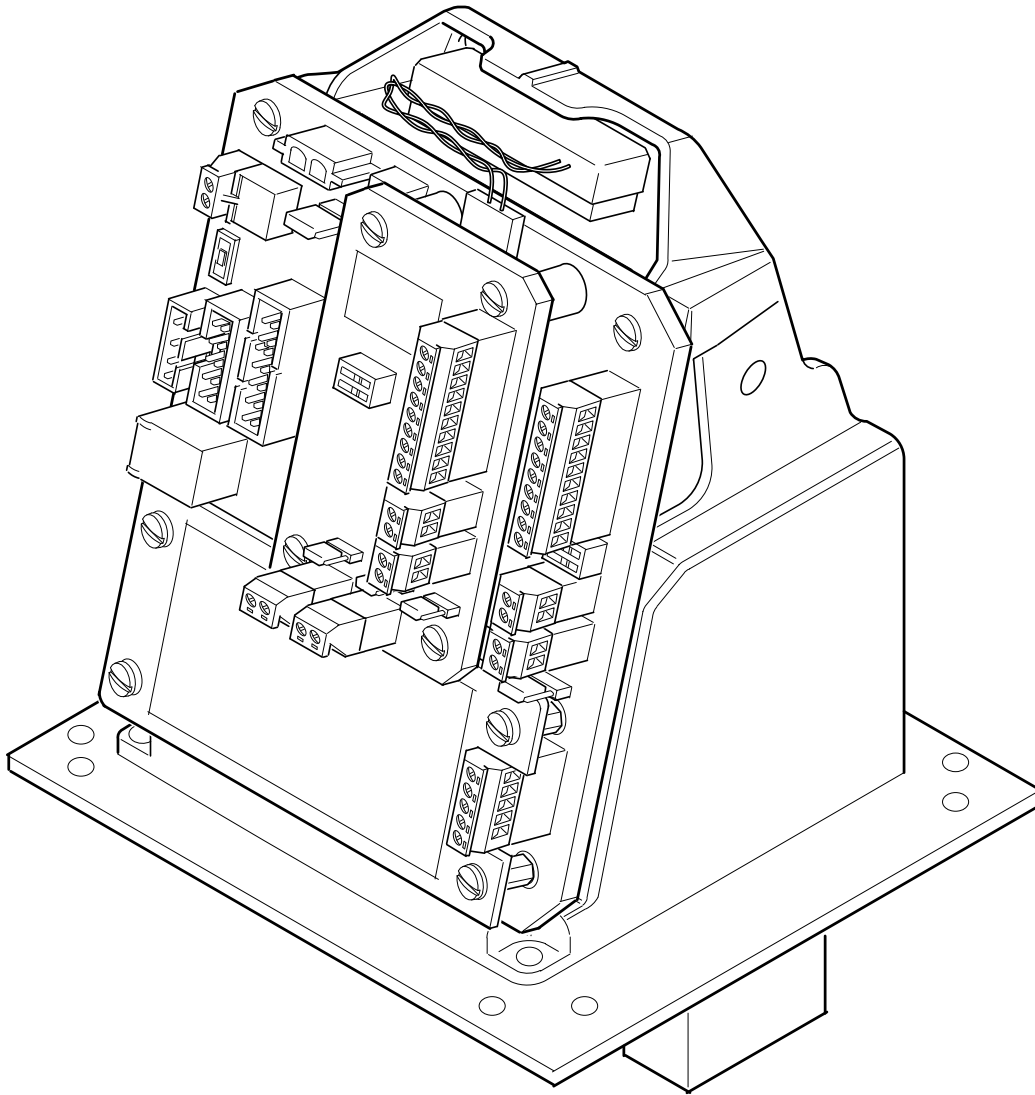

Intellectual Property & Copyright Notice

©2018 by ABB Inc., Totalflow ("Owner"), Bartlesville, Oklahoma 74006, U.S.A. All rights reserved.

Any and all derivatives of, including translations thereof, shall remain the sole property of the Owner, regardless of any circumstances.

The original US English version of this manual shall be deemed the only valid version. Translated versions, in any other language, shall be maintained as accurately as possible. Should any discrepancies exist, the US English version will be considered final.

Notice: This publication is for information only. The contents are subject to change without notice and should not be construed as a commitment, representation, warranty, or guarantee of any method, product, or device by Owner.

Inquiries regarding this manual should be addressed to ABB Inc., Totalflow Products, Technical Communications, 7051 Industrial Blvd., Bartlesville, Oklahoma 74006, U.S.A.

TABLE OF CONTENTS

INTRODUCTION	XIII
Organization & Style	xiii
Chapter Descriptions	xiii
Getting Help.....	xiii
Before Calling	xiii
Key Symbols.....	xiv
Safety Practices and Precautions	xiv
Safety Guidelines	xiv
Safety First.....	xiv
Equipment Markings.....	xv
Grounding the Product	xv
Operating Voltage.....	xv
Danger From Loss of Ground.....	xv
Safe Equipment	xvi
Fuse Replacement	xvi
Compliance.....	xvi
1.0 SYSTEM DESCRIPTION	1-1
1.1 Overview	1-1
1.1.1 Capabilities	1-1
1.1.2 Functionality	1-1
1.1.3 μ FLO ^{G4} Calculations	1-3
1.1.4 Additional Features.....	1-3
1.1.5 Log Period Records.....	1-4
1.1.6 Display Function	1-5
1.1.7 Display Annunciators.....	1-6
1.2 μ FLO ^{G4} Computer Hardware	1-7
1.2.1 Enclosure.....	1-8
1.2.2 μ FLO ^{G4} Board.....	1-11
1.2.3 Engine Card.....	1-16
1.2.4 Integral Multivariable Transducer (IMV)	1-16
1.2.5 Optional I/O Card.....	1-17
1.2.6 Resistive Temperature Detector (RTD).....	1-17
1.2.7 Solar Panel	1-18
1.3 μ FLO ^{G4} Application Licensing.....	1-18
1.3.1 Credit Key (USB)	1-18
1.4 Laptop Computer Running PCCU32	1-19
1.5 Local μ FLO ^{G4} Connections.....	1-19
1.5.1 Bluetooth Connectivity.....	1-19
1.5.2 RS-232 Serial PCCU Cable (Round Military Connector)	1-19
1.5.3 PCCU32 USB Connection.....	1-20
1.6 Network Connectivity (Dynamic IP with Router)	1-21
2.0 INSTALLATION	2-1
2.1 Unpacking and Inspection	2-1
2.1.1 Unpacking.....	2-1
2.1.2 Inspection	2-1

2.1.3	Damaged Components	2-1
2.2	Installation Overview	2-1
2.3	Pipe Mount Installation.....	2-2
2.3.1	Materials Supplied	2-2
2.3.2	Materials Not Supplied	2-2
2.3.3	Step-by-Step Instructions.....	2-2
2.4	Wall Mount Installation	2-3
2.4.1	Optionally Supplied Materials	2-3
2.4.2	Materials Not Supplied	2-3
2.4.3	Step-by-Step Instructions.....	2-4
2.5	Direct Mount Installation.....	2-4
2.5.1	Step-by-Step Instructions.....	2-4
2.6	Manifold Input Lines.....	2-5
2.6.1	Materials Not Supplied	2-5
2.6.2	Step-by-Step Instructions.....	2-6
2.7	Battery Pack Installation.....	2-7
2.7.1	Step-by-Step Instructions.....	2-7
2.8	Lithium Battery Installation	2-7
2.9	Solar Panel Installation	2-8
2.9.1	Materials Supplied	2-8
2.9.2	Materials Not Supplied	2-9
2.9.3	Step-by-Step Instructions.....	2-9
2.10	External Power to the μ FLO ^{G4} Board (9-30 Vdc).....	2-10
2.10.1	Step-by-Step Instructions.....	2-10
2.11	RTD Probe Installation	2-11
2.11.1	Optionally Supplied Materials	2-11
2.11.2	Materials Not Supplied	2-11
2.11.3	Step-by-Step Instructions.....	2-11
2.12	AC Charging Unit Installation	2-13
2.12.1	Materials Supplied	2-13
2.12.2	Materials Not Supplied	2-13
2.12.3	Step-by-Step Instructions.....	2-13
2.13	μ FLO ^{G4} Communication, Jumper Settings and Field Wiring	2-14
2.13.1	Communication Wiring.....	2-14
2.13.2	Board Configuration	2-15
3.0	STARTUP.....	3-1
3.1	Overview.....	3-1
3.2	PCCU32 Installation and Setup.....	3-1
3.2.1	Step-by-Step Instructions.....	3-1
3.3	Establishing Local Communication	3-1
3.3.1	Connecting to Local Port Via a RS-232 Cable.....	3-1
3.3.2	Connecting to the Local USB Port	3-3
3.3.3	Setup of the μ FLO ^{G4} for Ethernet Connectivity.....	3-6
3.3.4	Setup of the μ FLO ^{G4} for Bluetooth Connectivity	3-11
3.4	Setting Up the μ FLO ^{G4}	3-15
3.4.1	Station ID	3-15

3.4.2	Device ID/Application ID.....	3-15
3.4.3	Location	3-15
3.4.4	Date/Time	3-16
3.5	Security Systems	3-16
3.5.1	Device Security.....	3-16
3.5.2	WinCCU32 Security.....	3-18
3.5.3	Role Based Access Control (RBAC)	3-19
3.6	Application Licensing Credit Key	3-27
3.6.1	Credit Key Driver Installation	3-27
3.6.2	Access/View the Credit Key with PCCU32 7.0 (or later)	3-27
3.6.3	Adding Credits to the Credit Key by Telephone	3-29
3.6.4	Transferring Credits to the μ FLO ^{G4} from the Credit Key	3-30
3.6.5	Transferring Credits to the Credit Key from the μ FLO ^{G4}	3-32
3.7	μ FLO ^{G4} Configuration.....	3-33
3.7.1	Contract Hour	3-33
3.7.2	Log Period	3-33
3.7.3	Volume Calculation Period	3-34
3.7.4	Calculated Method.....	3-34
3.7.5	Super Compressibility Calculation (Fpv)	3-35
3.7.6	Constants	3-36
3.7.7	Alarm Limits.....	3-36
3.7.8	Reset Volume	3-37
3.8	Start Up the μ FLO ^{G4}	3-37
3.8.1	Putting the μ FLO ^{G4} On-Line	3-37
3.8.2	Setting the μ FLO ^{G4} Temperature Calculation.....	3-37
3.9	μ FLO ^{G4} Standard Displays	3-38
3.9.1	Program Display	3-38
4.0	MAINTENANCE.....	4-1
4.1	Overview	4-1
4.1.1	Maintenance Support	4-1
4.1.2	How to Use This Chapter	4-1
4.1.3	Cleanliness	4-1
4.1.4	Front-Mounted LCD.....	4-1
4.1.5	Returning Parts for Repair.....	4-1
4.2	μ FLO ^{G4} Component Breakdown	4-2
4.3	Backing Up Configuration Files	4-2
4.3.1	Step-by-Step Instructions	4-3
4.4	Restoring Configuration Files	4-3
4.4.1	Step-by-Step Instructions	4-3
4.5	Performing a Warm Boot.....	4-3
4.5.1	Hardware Warm Boot.....	4-3
4.5.2	Software Warm Boot	4-4
4.6	Performing a Cold Boot.....	4-5
4.6.1	Hardware Cold Boot	4-5
4.6.2	Software Cold Boot.....	4-6
4.7	Changing the μ FLO ^{G4} Clock.....	4-6
4.7.1	Clock Change Not Crossing an Hourly Boundary	4-7

4.7.2	Forward Clock Change Crossing an Hourly Boundary	4-7
4.7.3	Backward Clock Change Crossing an Hourly Boundary	4-7
4.8	Replacing the μ FLO ^{G4} Battery Pack	4-7
4.8.1	Step-by-Step Instructions	4-8
4.9	Replacing the μ FLO ^{G4} Board	4-9
4.9.1	Step-by-Step Instructions (Engine Card Attached)	4-9
4.9.2	Step-by-Step Instructions (Retaining Original Engine Card)	4-10
4.9.3	Step-by-Step Instructions	4-10
4.10	Replacing the Optional I/O Card	4-12
4.10.1	Step-by-Step Instructions	4-12
4.11	Replacing the Liquid Crystal Display (LCD)	4-13
4.11.1	Step-by-Step Instructions	4-13
4.12	Replacing the Lithium Battery	4-14
4.12.1	Step-by-Step Instructions	4-14
4.13	Replacing the IMV	4-15
4.13.1	Step-by-Step Instructions	4-15
4.14	Calibration	4-16
4.14.1	Required Test Equipment	4-17
4.14.2	Hold Mode	4-17
4.14.3	Static Pressure (SP) Calibration Checks	4-17
4.14.4	Differential Pressure (DP) Calibration Checks	4-20
4.14.5	Calibrating Static Pressure	4-22
4.14.6	Calibrating Differential Pressure (DP)	4-23
4.14.7	Optional I/O Card Calibration	4-24
4.15	Zero Transducer	4-26
4.15.1	Static Pressure	4-27
4.15.2	Differential Pressure	4-27
4.16	RTD Calibration and Bias	4-27
4.16.1	Step-by-Step Instructions	4-27
4.16.2	Calibrating RTD Temperature Bias	4-28
4.17	Changing the Orifice Plate	4-29
4.17.1	Taking the Meter Run Out of Service (Simplex Fitting)	4-29
4.17.2	Leaving Meter Run In Service Procedure (Senior Fitting)	4-29
5.0	TROUBLESHOOTING	5-1
5.1	Overview	5-1
5.1.1	Troubleshooting Support	5-1
5.1.2	Visual Alarm Codes	5-1
5.1.3	Sleep Mode	5-1
5.1.4	Solar Panel	5-1
5.1.5	Communication	5-1
5.2	Troubleshooting Visual Alarm Codes	5-2
5.2.1	Troubleshooting a Blank LCD Screen	5-4
5.2.2	Troubleshooting a Low Lithium Alarm (^L _L)	5-4
5.2.3	Troubleshooting a Low Charger Alarm (^L _C)	5-4
5.2.4	Troubleshooting a Analog to Digital Failure Alarm (^A _D)	5-5
5.2.5	Resistive Temperature Detector (RTD) Continuity Test	5-6
5.2.6	RTD Current Source (Resistive) Test	5-7

5.2.7	RTD Impedance Test	5-7
5.3	Power Troubleshooting	5-8
5.3.1	Power Supply Test	5-9
5.3.2	Solar Panel Charging System Test	5-10
5.3.3	AC Charging System	5-12
5.3.4	Auxiliary Equipment Isolation Test	5-12
5.3.5	Sleep Mode	5-13
5.3.6	Reset Procedures	5-14
5.4	Troubleshooting Communications	5-15
5.4.1	Setting Up Communication	5-17
5.4.2	Transceiver Supply Voltage Test	5-17
5.4.3	12 V Communication Supply Voltage Test	5-17
5.4.4	Transceiver Check	5-18
5.4.5	RS-232 Communication Test	5-19
5.4.6	RS-485 Communication Test	5-20
APPENDIX A	μFLO^{G4} MODBUS REGISTER MAPS	A-1
A.1	System Application Registers	A-1
A.1.1	System Application Register Notes	A-3
A.2	Display Application Registers	A-5
A.2.1	Display Application Register Notes	A-7
A.3	Alarm System Application Registers	A-8
A.3.1	Alarm Systems Application Register Notes	A-10
A.4	Holding Registers	A-11
A.4.1	Holding Register Notes	A-12
A.5	Reports Application Registers	A-13
A.5.1	Reports Register Notes	A-14
A.6	Operations Application Registers	A-14
A.6.1	Operations Application Register Notes	A-24
A.7	Communication Application Registers	A-27
A.7.1	Communication Application Register Notes	A-29
A.8	Safety Controller Application Registers	A-31
A.8.1	Array Types	A-31
A.8.2	General Registers	A-32
A.8.3	Safety Controller Registers Notes	A-33
A.9	μFLO ^{G4} IOS Application Registers	A-34
A.10	AGA-3 Measurement Tube Application Registers	A-34
A.10.1	AGA-3 Tube Byte Registers	A-35
A.10.2	Tube 16-Bit Integer Registers	A-38
A.10.3	Tube 32-Bit Integer Registers	A-40
A.10.4	Tube Floating Point Registers	A-40
A.10.5	Tube Register Cross Reference	A-43
A.10.6	Tube String Registers	A-43
A.10.7	Tube Last Calculation Period Analysis Registers, Floating Point	A-44
A.10.8	Tube Archive Registers – Read Only	A-44
A.10.9	Tube Log Period Registers	A-44
A.10.10	Tube Daily Registers	A-46
A.10.11	Tube Events Registers	A-47

	A.10.12 AGA-3 Tube Registers	A-47
	A.10.13 AGA-3 Float Registers	A-48
	A.10.14 AGA-3 String Registers.....	A-50
	A.10.15 AGA-3 Int32 Registers	A-50
A.11	AGA-7 Tube Application Registers.....	A-51
	A.11.1 Tube Byte Registers	A-51
	A.11.2 Tube 16-Bit Integer Registers.....	A-54
	A.11.3 Tube 32-Bit Integer Registers.....	A-56
	A.11.4 Tube Floating Point Registers.....	A-56
	A.11.5 Tube Register Cross Reference	A-59
	A.11.6 Tube String Registers	A-60
	A.11.7 Tube Last Calculation Period Analysis Registers, Floating Point.....	A-60
	A.11.8 Tube Archive Registers, Read Only.....	A-60
	A.11.9 Tube Daily Registers.....	A-62
	A.11.10 Tube Event Registers	A-63
	A.11.11 AGA-7 Tube Byte Registers.....	A-63
	A.11.12 AGA-7 Float Registers	A-65
	A.11.13 AGA-7 String Registers.....	A-67
	A.11.14 AGA-7 Int32 Registers	A-67
A.12	XMV Interface Application.....	A-67
	A.12.1 XMV Application Register Notes.....	A-74
A.13	Therms Master Application Registers.....	A-75
	A.13.1 Therms Master Btu Byte Registers	A-76
	A.13.2 Therms Master Btu Integer Registers.....	A-76
	A.13.3 Therms Master Btu Float Register	A-78
	A.13.4 Therms Master Stream 1 Float Registers	A-79
	A.13.5 Therms Master Stream 2 float Registers	A-80
	A.13.6 Therms Master Stream 3 Float Registers	A-82
	A.13.7 Therms Master Stream 4 Float Registers	A-83
	A.13.8 Therms Master Btu Var Integer Registers	A-84
	A.13.9 Therms Master Btu Var Int32 Registers	A-85
	A.13.10 Therms Master Slave Data Trigger Registers	A-85
	A.13.11 Therms Master Current Stream Float Registers.....	A-85
	A.13.12 Therms Master Slave Var Integer Registers.....	A-86
	A.13.13 Therms Master Stream Time String Register	A-87
	A.13.14 Therms Master Slave Var Integer Registers.....	A-87
A.14	Therms Display Registers	A-87
	A.14.1 Therms Status Btu Integer Registers.....	A-87
	A.14.2 Therms Status Float Registers	A-88
	A.14.3 Therms Stream SN Int32 Registers	A-89
	A.14.4 Therms Master Component Xref Index Registers	A-89
	A.14.5 Therms Master Btu Byte Registers	A-90
	A.14.6 Therms Master Component Xrefed Index Registers	A-90
	A.14.7 Therms Slave Var Modbus Address Registers.....	A-91
	A.14.8 Therms Slave Var Modbus Address Registers.....	A-92
	A.14.9 Therms Interface Control Get Request Registers.....	A-92
	A.14.10 Therms Master Int32 Registers.....	A-92
	A.14.11 Therms Slave Stream 1 Float Registers	A-92
	A.14.12 Therms Slave Stream 2 Float Registers.....	A-93
	A.14.13 Therms Slave Stream 3 Float Registers	A-94

A.14.14	Therms Master Slave Stream 4 Float Registers	A-94
A.14.15	Therms Master Slave Analysis Trend File.....	A-95
A.15	Therms Slave Application Registers.....	A-96
A.15.1	Therms Slave Float Registers	A-96
A.15.2	Therms Slave String Registers.....	A-98
A.15.3	Therms Slave Int32 Registers	A-98
A.15.4	Therms Slave Stream 1 Float Registers	A-98
A.15.5	Therms Slave Stream 2 Float Registers	A-99
A.15.6	Therms Slave Stream 3 Float Registers	A-99
A.15.7	Therms Slave Stream 4 Float Registers	A-100
A.15.8	Therms Slave Analysis Trend File.....	A-101

TABLE OF FIGURES

Figure 1-1 Liquid Crystal Display and Indicators	1-6
Figure 1-2 μ FLO ^{G4} Enclosure.....	1-9
Figure 1-3 μ FLO ^{G4} Enclosure Left Side	1-9
Figure 1-4 μ FLO ^{G4} Enclosure Right Side	1-10
Figure 1-5 μ FLO ^{G4} Enclosure Bottom View	1-10
Figure 1-6 μ FLO ^{G4} Board	1-12
Figure 1-7 Typical Point Schematic	1-14
Figure 1-8 Example Connections.....	1-14
Figure 1-9 Typical Point Schematic	1-15
Figure 1-10 Example Connections.....	1-15
Figure 1-11 Optional I/O Card.....	1-17
Figure 1-12 RS-232 Local Communication Cable	1-20
Figure 1-13 USB Local Communication Cable	1-20
Figure 1-14 Ethernet Communication Cable.....	1-21
Figure 2-1 Typical Pipe Installation.....	2-2
Figure 2-2 Typical Pipe Saddle Installation.....	2-3
Figure 2-3 μ FLO ^{G4} Direct Mounted	2-5
Figure 2-4 Transducer Low and High Side Ports.....	2-6
Figure 2-5 μ FLO ^{G4} Board Battery and Charger Input Connections	2-7
Figure 2-6 Lithium Battery.....	2-8
Figure 2-7 Typical Solar Panel Installation	2-9
Figure 2-8 External Power to μ FLO ^{G4} Board	2-11
Figure 2-9 Thermowell Installation into Meter Run	2-12
Figure 2-10 RTD Probe Wiring.....	2-12
Figure 2-11 RTD Input Connections	2-13
Figure 2-12 μ FLO ^{G4} Standard Communication Wiring	2-15
Figure 2-13 μ FLO ^{G4} Main Board Configuration.....	2-16
Figure 3-1 System Setup Screen	3-2
Figure 3-2 Local Connect Screen	3-3
Figure 3-3 Windows Found New Hardware Wizard.....	3-4
Figure 3-4 Specific Location Selection.....	3-4
Figure 3-5 Specify Location for USB Driver (Totalflow.inf)	3-5
Figure 3-6 PCCU32 Network Tab	3-7
Figure 3-7 Totalflow-TCP Setup Tab	3-7
Figure 3-8 System Setup Dialog Box.....	3-8
Figure 3-9 Windows Desktop Shortcut Dialog Box	3-9
Figure 3-10 Network Tab	3-10
Figure 3-11 System Setup Dialog Box.....	3-11
Figure 3-12 Communications Setup Tab - Bluetooth.....	3-12
Figure 3-13 Add/Modify Communication Devices and Applications Dialog Box - Bluetooth	3-13
Figure 3-14 System Setup Dialog Box - Bluetooth	3-14
Figure 3-15 Select a Bluetooth Device Dialog Box	3-14
Figure 3-16 Station Setup Tab.....	3-17

Figure 3-17 System Setup Dialog Box	3-18
Figure 3-18 WinCCU32 Edit a Device ID Dialog Box.....	3-19
Figure 3-19 Role Administration Menu Path	3-20
Figure 3-20 Security Editor Dialog Box	3-20
Figure 3-21 Roles Dialog Box.....	3-21
Figure 3-22 User Name and Password Dialog Box.....	3-22
Figure 3-23 System Setup Dialog Box – Directory Paths Tab	3-23
Figure 3-24 Send Role Based Access Control File	3-23
Figure 3-25 Totalflow-TCP Setup Tab.....	3-24
Figure 3-26 Login Dialog Box.....	3-25
Figure 3-27 System Setup Dialog Box	3-25
Figure 3-28 Security Log Tab	3-26
Figure 3-29 Credit Key License Utility	3-28
Figure 3-30 Credit Key License Utility - Status.....	3-29
Figure 3-31 Application Credit Key Entry Screen.....	3-30
Figure 3-32 App Licensing Tab	3-31
Figure 3-33 Transfer to Credit Key	3-33
Figure 4-1 μ FLO ^{G4} Exploded View	4-2
Figure 4-2 Reset Button Location.....	4-4
Figure 4-3 Lithium Battery Connector	4-6
Figure 4-4 μ FLO ^{G4} Board Cutout Maintenance	4-8
Figure 4-5 Battery Shelf.....	4-9
Figure 4-6 Engine Card Removal.....	4-11
Figure 4-7 Engine Card Installation	4-12
Figure 4-8 μ FLO ^{G4} Board – J2 Connector	4-13
Figure 4-9 Lithium Battery Cable and Connector	4-15
Figure 4-10 Calibration Screen - SP.....	4-19
Figure 4-11 Calibration Screen - DP	4-21
Figure 4-12 RTD Calibration Screen	4-27
Figure 5-1 Troubleshooting Flowchart.....	5-2
Figure 5-2 Liquid Crystal Display and Indicators.....	5-3
Figure 5-3 Battery Charger and Battery Pack Connections	5-4
Figure 5-4 Power Troubleshooting Flowchart	5-9
Figure 5-5 μ FLO ^{G4} Board	5-11
Figure 5-6 Current Measurement Troubleshooting Cable.....	5-13
Figure 5-7 Communication Troubleshooting Flowchart.....	5-16
Figure 5-8 μ FLO ^{G4} Communication Wiring.....	5-18

LIST OF TABLES

Table 1-1 Typical μ FLO ^{G4} Display Options	1-5
Table 1-2 μ FLO ^{G4} Status and Alarm Descriptions	1-6
Table 1-3 μ FLO ^{G4} Board Specifications	1-12
Table 1-4 IMV Specifications	1-16
Table 2-1 μ FLO ^{G4} Onboard Jumper Settings.....	2-15
Table 3-1 Configurable Calculation Factors.....	3-34
Table 3-2 Fpv Analysis Data	3-35
Table 3-3 Gas Orifice Constants.....	3-36
Table 3-4 Alarm Limits	3-36
Table 3-5 μ FLO ^{G4} Displayed Items	3-38
Table 4-1 Calibration Configurable Parameters.....	4-16
Table 5-1 Visual Alarm Codes	5-3
Table 5-2 Specifications for Solar Panels	5-12
Table 5-3 RS-232 Field Wiring on μ FLO ^{G4} Electronic Board.....	5-19
Table 5-4 RS-485 Field Wiring on the μ FLO ^{G4} Board.....	5-20

Introduction

This manual is written to provide an experienced meter technician with the requirements necessary to install, set up and operate an ABB Totalflow μ FLO^{G4} flow computer.

Organization & Style

Each of the chapters in this manual presents information in an organized and concise manner. Readers are able to look at the headings and receive a broad picture of the content without reading every word. Also, there are overviews at the beginning of each chapter that provides the user with an idea of what is in the chapter and how it fits into the overall manual.

Chapter Descriptions

Chapter	Name	Description
1	System Description	Provides a description of the Totalflow μ FLO ^{G4} system components and specifications.
2	Installation	Includes unpacking and detailed procedures for setup and installation.
3	Startup	Provides you with a tutorial on how to get a newly installed μ FLO ^{G4} system up and running.
4	Maintenance	Provides instructions on how to remove and replace major modules.
5	Troubleshooting	Provides a description of the μ FLO ^{G4} front panel error messages and provides a troubleshooting chart on how to correct most problems.
Appdx. A	Modbus Register Tables	Provides a listing of all valid Modbus Registers.

Getting Help

ABB Totalflow takes pride in the ongoing support provided to customers. When purchasing a product, users receive documentation which should answer their questions; however, ABB Totalflow Technical Support provides an 800 number as an added source of information.

If requiring assistance, call:

USA: (800) 442-3097





International: 001-918-338-4888

Before Calling

- Know the ABB Totalflow model and serial number. Serial numbers can be found on a plate located on each unit.
- Be prepared to give the customer service representative a detailed description of the problem.
- Note any alarms or messages as they appear.
- Prepare a written description of problem.
- Know the software version, board and optional part numbers.

Key Symbols

The following symbols are used frequently in the manual. These are intended to catch the eye and draw attention to important information.

- FYI**  Intended to draw attention to useful information or to clarify a statement made earlier.
- TIP**  Intended to draw attention to a fact that may be useful or helpful in understanding a concept.
- CAUTION**  Intended to draw attention to a statement that might keep the user from making a mistake, keep the user from destroying equipment or parts or keep the user from creating a situation that could cause personal injury if caution is not used. Please refer to the Safety Practices and Precaution section for additional information.
- WARNING**  Intended to draw attention to a statement regarding the likelihood of personal injury or fatality that could result from improper access or techniques used while working in hazardous locations. Please refer to the Safety Practices and Precaution section for additional information.

Safety Practices and Precautions

This manual contains information and warnings which have to be followed by the user to ensure safe operation and to retain the product in a safe condition. Installation, maintenance and repairs should only be performed by a trained and qualified technician. Please refer to the certification drawings shipped with this unit for specific guidelines. Extra copies of the certification drawings, referenced on the unit's name tag, can be obtained, free of charge, by contacting ABB Totalflow Technical Support at the number listed in the Getting Help section.

Safety Guidelines

- DO NOT open the equipment to perform any adjustments, measurements, maintenance, parts replacement or repairs until all external power supplies have been disconnected.
- Only a properly trained technician should work on any equipment with power still applied.
- When opening covers or removing parts, exercise extreme care. Live parts or connections can be exposed".
- Installation and maintenance must be performed by person(s) qualified for the type and area of installation, according to national and local codes.
- Capacitors in the equipment can still be charged even after the unit has been disconnected from all power supplies.

Safety First

Various statements in this manual, identified as conditions or practices that could result in equipment damage, personal injury or loss of life, are highlighted using the following icons.



CAUTION

Exercise caution while performing this task. Carelessness could result in damage to the equipment, other property and personal injury.



WARNING

STOP. Do not proceed without first verifying that a hazardous condition does not exist. This task may not be undertaken until proper protection has been implemented or the hazardous condition has been removed. Personal injury or fatality could result. Examples of these warnings include:

- Removal of enclosure cover(s) in a hazardous location must follow guidelines stipulated in the certification drawings shipped with this unit.
- If the unit is installed or to be installed in a hazardous location, the technician must follow the guidelines stipulated in the certification drawings shipped with this unit.
- Access to the unit via PCCU cable, external USB or Bluetooth adapter in a hazardous location must follow guidelines stipulated in the certification drawings shipped with this unit.
- Connecting or disconnecting equipment in a hazardous location for installation or maintenance of electric components must follow guidelines stipulated in the certification drawings shipped with this unit.

WARNING indicates a personal injury hazard immediately accessible as one reads the markings.

CAUTION indicates a personal injury hazard not immediately accessible as one reads the markings or a hazard to property, including the equipment itself.

Equipment Markings



Ground (earth) terminal.

Grounding the Product

If a grounding conductor is required, it should be connected to the grounding terminal before any other connections are made.

Operating Voltage

Before switching on the power, check that the operating voltage listed on the equipment agrees with the power being connected to the equipment.

Danger From Loss of Ground

A grounding conductor may or may not be required depending on the installation method used, the environmental and hazardous classification requirements. If required, any interruption of the grounding conductor inside or outside the equipment or loose connection of the grounding conductor can result in a dangerous unit. Intentional interruption of the grounding conductor is not permitted.

Safe Equipment

If it is determined that the equipment cannot be operated safely, it should be taken out of operation and secured against unintentional usage.

Fuse Replacement

Fuses used on the μ FLO^{G4} electronic boards are surface-mount, and field repair should not be attempted. Most fuses automatically reset themselves, but if a known problem exists, the board should be sent in for repair or replacement.

Compliance

EU Directive 2012/19/EU - Waste Electrical and Electronic Equipment (WEEE)

ABB Industrial Automation, Measurement and Analytics, is committed to actively protecting the environment. Do not dispose of WEEE as unsorted municipal waste. Collect WEEE separately. Participation in the management of WEEE is critical to the success of WEEE collection.

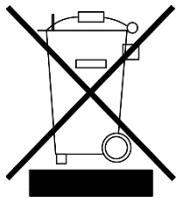

Electrical and electronic equipment marked using the crossed-out wheeled bin symbol shall not be mixed with general household waste. Correct disposal at a recycling facility will help save valuable resources and prevent potential negative effects on health and the environment. These steps ensure compliance with the Waste Electrical and Electronic Equipment (WEEE) Directive.

Waste electrical and electronic equipment (WEEE) shall be treated separately using the national collection framework available to customers for the return, recycling, and treatment of WEEE.

1.0 SYSTEM DESCRIPTION

1.1 Overview

The ABB Totalflow® μ FLO^{G4} flow computer is a next generation solution for the pre-existing μ FLO flow computer. Representing a leap forward, the μ FLO^{G4} now incorporates the same 32-bit technology that is currently used by ABB Totalflow's G4 XSeries product line. By using this 32-bit technology, Windows® CE OS and expanded memory capabilities, the μ FLO^{G4} is a versatile product offering for Div 2 and general purpose custody measurement projects.

Along with this new functionality, the hardware capabilities will also be expanded to meet the demands of targeted market applications in production automation and natural gas distribution. These hardware features are then used to enhance the system integration capabilities with existing Totalflow products as well as third-party control SCADA systems.

Additionally, the use of Bluetooth technology for local MMI connectivity is poised to enhance the product for single-tube measurement where this type of user interface is an advantage.

The μ FLO^{G4} is an accurate and reliable single tube differential or linear gas flow computer with the capability to measure and monitor gas flow in compliance with AGA and API standards. The μ FLO^{G4} is a low power, microprocessor-based unit designed to meet a wide range of measurement, monitor and alarming applications for remote gas systems.

The symbol μ stands for the Greek word meaning micro or mu. The letters FLO are an abbreviation of the word 'flow'. As the name implies, the μ FLO^{G4} is a flow computer that is designed to meet basic functional requirements.

1.1.1 Capabilities

The μ FLO^{G4} defaults to a retention of daily and log period records for 40 days and the retention of 200 events. These defaults can be extended and are limited only by the file space on the device.

The μ FLO^{G4} may be used in conjunction with a laptop that is running PCCU32 software. PCCU32 is required for initial setup and the setup of the advanced features.

The μ FLO^{G4} maintains a history of alarms as well as average differential pressure (DP), average static pressure (SP), average flowing temperature (Tf), accumulated volume, energy and an average extension.

The μ FLO^{G4} can be programmed to calculate flow rates and volumes in accordance with AGA-3, ISO-5167 or AGA-7.

Super compressibility calculations can be performed in accordance with NX-19, AGA-8 or ISO 12213-2.

1.1.2 Functionality

Functions of the μ FLO^{G4} reflect a design that is practical, straightforward and efficient. The μ FLO^{G4} is simple and easy to learn. This functionality allows for saving time that is usually allotted for calculations and report preparation. The

μFLO^{G4} allows the user to perform the following with a minimum of effort, maximum speed and greater accuracy.

1.1.2.1 AGA-3

Complete log period flow and operational records that are reported hourly (default), including:

- Average static pressure
- Average differential pressure
- Average flowing temperature
- Integral
- Corrected volume total
- Corrected energy total
- Operating status and alarms
- Flow time

Complete daily flow records, including:

- Average static pressure
- Average differential pressure
- Average flowing temperature
- Average integral
- Corrected volume total
- Corrected energy total
- Operating status and alarms

Complete daily operation statistics, including:

- Percent flowing time
- Percent back flow time
- Percent out of limits (programmable) on SP, DP, Tf and flow rate
- Minimum and maximum values for SP, DP, Tf and flow rate

1.1.2.2 AGA-7

Complete log period flow and operational records that are reported hourly (default), including:

- Average counts
- Average static pressure
- Average flowing temperature
- Uncorrected volume total
- Corrected volume total
- Corrected energy total
- Operating status and alarms
- Flow time

Complete daily flow records, including:

- Average total counts
- Average static pressure
- Average flowing temperature
- Average uncorrected volume
- Corrected volume total

- Corrected energy total
- Operating status and alarms

Complete daily operation statistics

- Percent flowing time
- Percent (low/high) uncorrected volume
- Percent out of limits (programmable) on SP, Tf and flow rate
- Minimum and maximum values for SP, Tf and flow rate

1.1.3 μ FLO^{G4} Calculations

The records and statistics generated are based on the following calculation methods of the μ FLO^{G4}:

- Calculation of flow rates and volumes in accordance with AGA 3-85, AGA 3-92, AGA-7 or ISO-5167.
- Calculation of the flow rates and volumes in accordance with AGA-8 92 Gross or Detail or NX-19 Super compressibility Standards.

- Calculation of the flow integral for the AGA 3-92 equation is: $\sqrt{\frac{Dp^* Sp}{Tf + 459.77}}$,

once per second.

- The flow extension reported for the log period is the total of the volume calculation divided by 3600. The total volume calculation period extensions are the sum of one second extensions. Each one second extension is:

$$\sqrt{\frac{Dp^* Sp}{Tf + 459.77}}$$

- Calculation of the flow extension for the AGA 3-85 equation is: $\sqrt{Dp^* Sp}$, once per second.
- Extrapolation of the flow accumulation during transducer calibration or calibration checks using the values for DP, SP and temperature at the time of entering Calibration mode.
- Dp, Sp and Tf are dynamic factors. Calculations that use these factors are based on the average of one second samples.
- Snapshot of the last calculation period inputs and calculation results can be used to verify calculation.
- Monitoring of the operational limits (minimums and maximums) to ensure detection and reporting of malfunctions or abnormal site conditions.
- Acceptance and storage of system constants from PCCU32 or remote communication protocols.
- The number of log records, daily records and events is user configurable.

1.1.4 Additional Features

Additional features of the ABB Totalflow system's flexibility include the following:

- Programmable differential pressure no flow cutoff.
- Programmable bi-level security codes or user-configurable Role Based Security Access (RBAC) to prevent unauthorized access to and configuration of the μ FLO^{G4}.
- Internal 100 Ohm, platinum RTD resistance curve fit with user-programmable single point offset or 3/5-point user-calibration of the RTD input.
- Quick, simple calibration procedures for the transducer.

- Real-time clock providing a highly stable time base for the system.
- Proper battery and solar sizing is determined by the geographic location of the unit and total power consumption of the system. ABB Totalflow project engineers can select the appropriate battery and solar requirements for the user's specific application. Various sizes are available.
- Three (3) available power sources:
 - External solar panel (standard)
 - External AC to DC power
 - External 9-30 Vdc power
- Liquid crystal display (LCD) programmable to allow monitoring of the $\mu\text{FLO}^{\text{G4}}$ operations and any variable that has a register (for example, displays voltage level of the batteries in the $\mu\text{FLO}^{\text{G4}}$).
- Rugged, aluminum, NEMA/TYP E 3R enclosure, lockable to prevent access.
- Ability to add third-party communication systems.
- Two (2) communication ports are available on the $\mu\text{FLO}^{\text{G4}}$ board: 1 dedicated local and 1 remote communication interface. $\mu\text{FLO}^{\text{G4}}$ board: One (1) serial port software configurable for RS-232, RS-485 or RS-422, one (1) Ethernet (10 BaseT) and one USB host/device port.
- One (1) optional I/O expansion card: One (1) serial port, software configurable for RS-232, RS-485 or RS-422. Additionally, it includes one (1) DI/PI, one (1) DO and two (2) AIs.

1.1.5 Log Period Records

Each record has entries that contain the following information:

1.1.5.1 AGA-3

- Average static pressure
- Average differential pressure
- Average flow temperature
- Calculated volume
- Calculated energy content
- Alarms
- Non zero flow
- Integral

1.1.5.2 AGA-7

- Average counts
- Average static pressure
- Average flow temperature
- Calculated volume
- Calculated energy content
- Average uncorrected volume'
- Alarms
- Non zero flow

1.1.5.3 Log Period Data Entries

Log period data entries are made every 60 minutes, by default. The user may change this period to any one of seven (7) choices (1, 2, 5, 10, 20, 30, 60). The log period must never be less than the volume calculation period.

1.1.5.4 Volume Calculation Period Entries

Volume calculation period entries are made every second, by default. API 21.1 strongly suggests a volume calculation period (QCP) of once per second.

The volume calculation period should never be greater than the log period and should be evenly divisible into the log period.

Volume calculations are completed, following the top of the current period (i.e., top of the hour, top of the minute, each second).

1.1.6 Display Function

During operation, the front panel LCD continuously scrolls through the operating parameters. Table 1-1 shows the typical displayed parameters; however, many parameters with a register address can be displayed. The duration that the parameter is displayed can vary from 1 to 255 seconds (default is five seconds). A setting of zero seconds will set any item to OFF. See the Program Display section and the PCCU32 help files for additional information.

Table 1-1 Typical μ FLO^{G4} Display Options

Display		Description
Station		
STATION ID		ID of unit
DATE/TIME HH:MM:SS	MM/DD/YY	Current date and time, 24-hour clock
CHARGER		Input voltage of the charging circuit
BATTERY VOLTAGE		Battery voltage as supplied by external unit
LITHIUM BACKUP		Display showing condition of the lithium battery
Tube		
TUBE # ID		ID of the tube
TUBE # ORIFICE DIAMETER INCHES	N.NNNN	Size of orifice plate
TUBE # SP		Static pressure absolute, PSIA
TUBE # DP H2O	NNN.N.IN.	Differential pressure, inches H2O
TUBE # TEMPERATURE F	NN.N DEG.	Flowing temperature, °F
TUBE # FLOW RATE SCF/HR	NNNNNN.N	Current flow rate, programmable SCF, MCF or MMCF

TUBE # LAST CALC		Last calculated volume
TUBE # YEST VOL MCF	NNNN.N	Yesterday's volume, programmable SCF, MCF or MMCF
TUBE # ACCUM VOL MCF	NNNNNN.NN	Total accumulated volume, programmable SCF, MCF or MMCF
DP HIGH		(Optional) Percentage of the day that the DP spent in a high status
DP LOW		(Optional) Percentage of the day that the DP spent in a low status

1.1.7 Display Annunciators

Since a primary function of the μ FLO^{G4} is to provide complete volume and operational records, it is important to indicate unusual or alarm conditions as they occur. This is supported on the LCD in the Annunciator display area as shown in Figure 1-1. The μ FLO^{G4} status and alarm descriptions are described in Table 1-2.

Whenever an alarm is indicated, the μ FLO^{G4} records it in the appropriate log period flow record. These are automatically retrieved when data is collected.

In the μ FLO^{G4}, the status and alarm code indicators are user-programmable. This allows the user to program each annunciator to reflect custom status information for different application or tube types. As supplied from the factory, a typical device will come with a standard display configuration but can be modified. Please consult the PCCU32 help files for additional instructions on programming the annunciators.

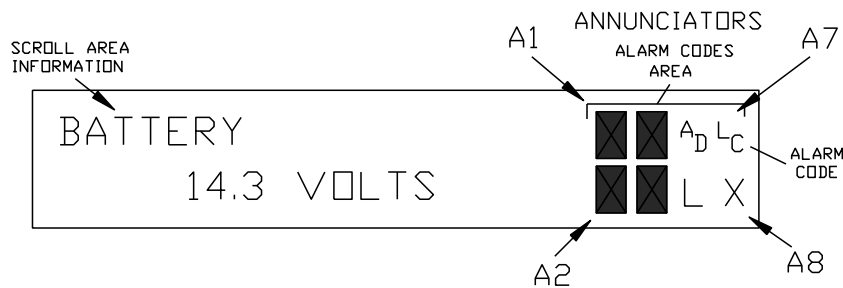

Figure 1-1 Liquid Crystal Display and Indicators

Table 1-2 μ FLO^{G4} Status and Alarm Descriptions

Indicator	Description
System	
L _L	Low Lithium Battery Alarm: When L _L (low lithium) is displayed, the lithium battery voltage is below 2.5 Vdc. A new lithium battery measures approximately 3.6 Vdc.
L _C	Low Charger: Displayed if the μ FLO ^{G4} battery charging voltage is (+) 0.4 Vdc or is less than or equal to the battery voltage.
Communication Protocols	

→	Transmitting Data: Sending a response.
←	Receiving Data: Processing request.
!	Nak: Negative acknowledgement with packet list.
+	Ack: Positive acknowledgement of receipt of request.
⋈	Waiting for Ack: Waiting for response after transmission.
?	Exception Alarm Processing
ƒ	ID Recognized: Recognized and receiving request.
⋈	Listen Cycle: Flashes if this remote port is active and running Totalflow Remote Protocol. Flashes in sync with the listening cycle that occurs at 1, 2 or 4 second intervals. May not be visible if the baud rate is faster than 2400. Annunciator will remain on listening cycle if the listen cycle is set to zero.
M	MODBUS ASCII: MODBUS ASCII protocol selected for the port assigned to this annunciator.
m	MODBUS RTU: MODBUS RTU protocol is selected for the port assigned to this annunciator.
L	Local Protocol: Displayed when PCCU port is active and running TOTALFLOW Local Protocol.
¥	ID Recognized: The ID has been recognized but is waiting for sync.
Measurement Application	
B _F	Back Flow Condition: Visible only when DP variable is displayed.
Z	Zero Flow Condition: Visible only when the flow rate is displayed.
H	Hold: Displayed when PCCU32 has entered
A	Alarm Condition: Need to view alarm. You may need to compare application limits to the current values to determine where the alarm condition is present.
A _D	A to D Failure: Displayed if the A to D Converter's absolute differential pressure, absolute static pressure or temperature readings exceed the maximum counts or are less than the minimum counts.
Display Application	
1	A number represents the Display Group number currently being displayed.
↑	The displayed item's value is above the Data High Limit value that is specified on the display Item Setup screen.
↓	The displayed item's value is below the Data Low Limit value specified on the display Item Setup screen.

1.2 μFLO^{G4} Computer Hardware

The ABB Totalflow μFLO^{G4} is housed in a lightweight, single-compartment aluminum case. The components that comprise this are as follows:

- Aluminum enclosure
- μFLO^{G4} board

- Engine card
- Integral multi-variable transducer (IMV)
- Liquid crystal display (LCD)
- Resistive temperature detector (RTD)
- Battery compartment shelf
- Communication area
- Charger or solar panel

1.2.1 Enclosure

The enclosure consists of a hinged-door box. The door provides a watertight, corrosion-resistant seal between the outside elements and the μ FLOG⁴ components. It is NEMA/TYP E 3R rated. Opening the door's latch allows access to electronics and the Integral Multivariable Transducer (IMV) components.



Remove power from the device, or ensure that the area is known to be non-hazardous before removing any enclosure cover. For further information, refer to the certification drawing indicated on the device's name tag and national and local electrical codes.

1.2.1.1 Dimensions

Unit	Width	Height	Depth
US	12.76"	14.88"	10.276"
Metric	32.4 cm	37.795 cm	26.101 cm

1.2.1.2 Installation and Weight

Unit	Weight (Pounds)	Pipe Mounted Depth	Wall Mounted
US	15.10 lbs	11.58"	11.02"
Metric	10.60 kg	294.23mm	279.88mm

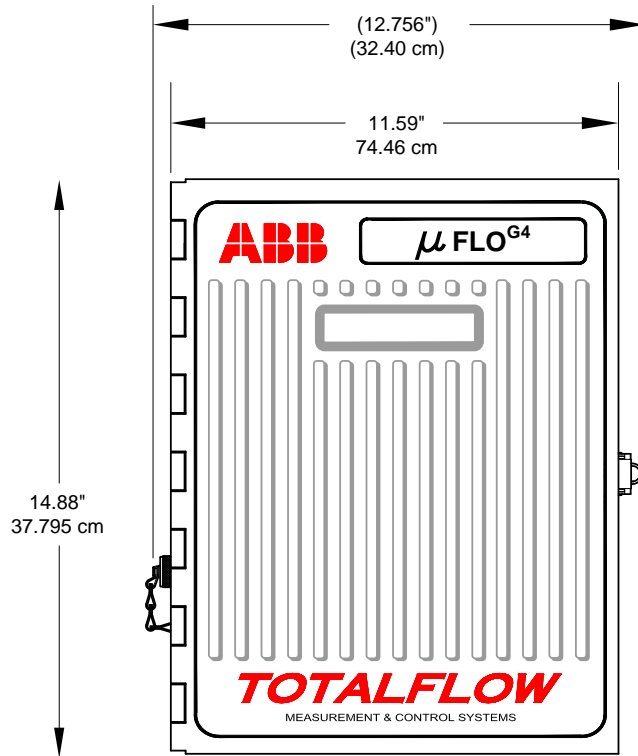

Figure 1-2 μFLO^{G4} Enclosure

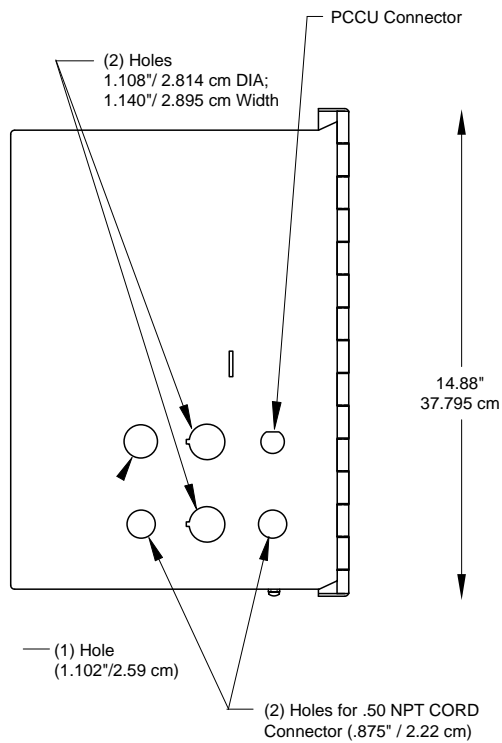

Figure 1-3 μFLO^{G4} Enclosure Left Side

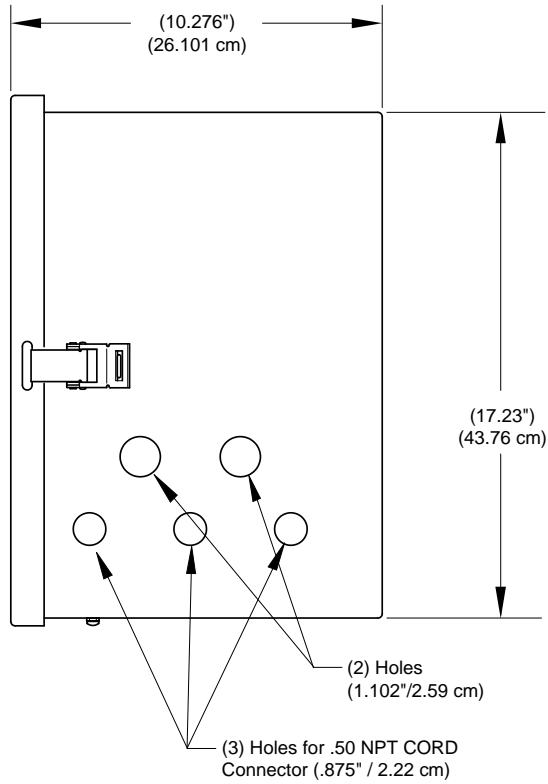

Figure 1-4 μFLO^{G4} Enclosure Right Side

(4) Holes for .50 NPT CORD – Connector (.875" / 2.22 cm)

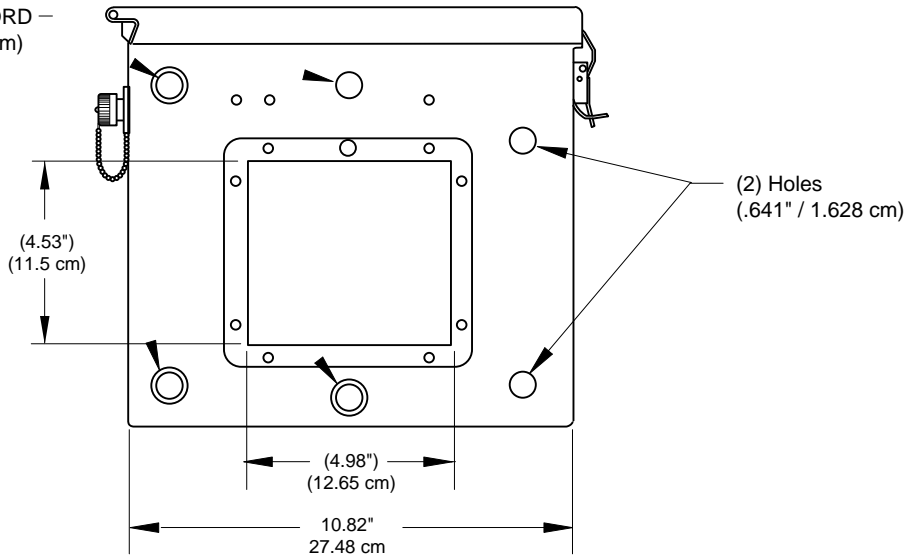

Figure 1-5 μFLO^{G4} Enclosure Bottom View

1.2.1.3 Battery Compartment Shelf

The battery compartment shelf houses various, optional battery packs that are available for the μFLO^{G4} that are from eight (8) ampere hours up to 26 ampere hours. The installation of the battery is discussed later in the manual.

1.2.1.4 Communication Area

Space is provided within the enclosure to house a variety of remote communication devices, transceivers, etc.

1.2.2 μ FLO^{G4} Board

The μ FLO^{G4} board is mounted directly on the IMV.

User applicable connections on this board consist of the following:

- uSD card (J7)
- USB (J4)
- Optional I/O card connector (J2)
- LCD display connector (J8)
- Engine card connector (XA1)
- Ethernet (J1)
- MMI connector (J9)
- Lithium battery connector (J18)
- Battery (J15)
- RTD (J3)
- COMM 1 (J10)
- DI/DO (J12/J13)
- External charger (J17)
- Power Options Jumper (J16)



Installation and/or maintenance of electric components must follow guidelines stipulated in the certification drawings shipped with this unit and adhere to national and local codes.

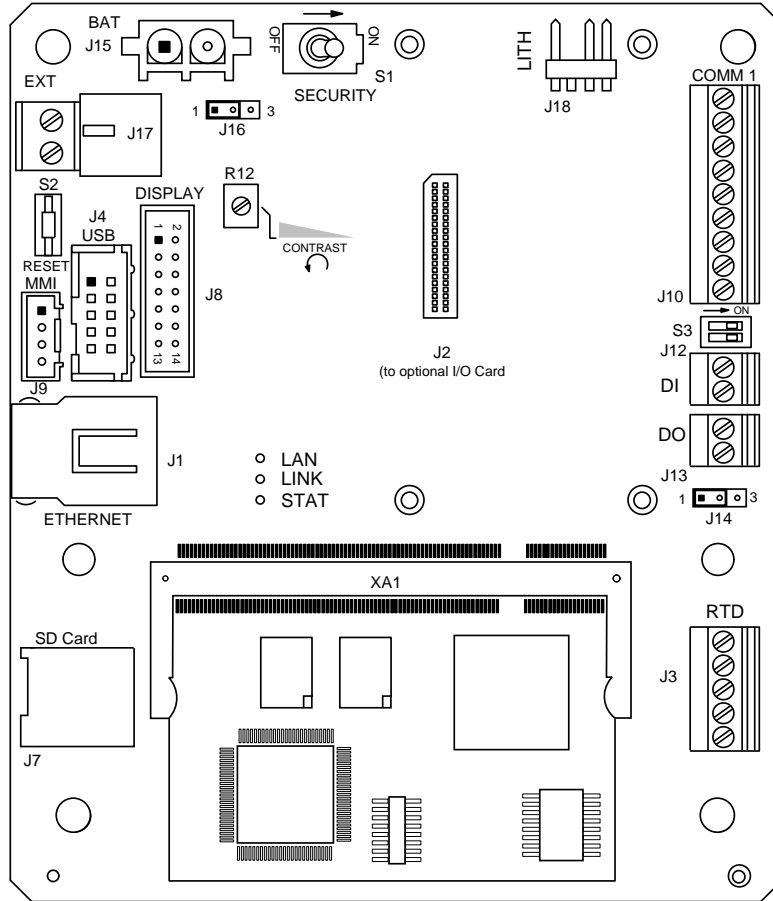

Figure 1-6 μFLO^{G4} Board

Table 1-3 μFLO^{G4} Board Specifications

Component	Description
12 V Lead-Acid Battery Power (J15)	<p>The input Voltage is 12 Vdc when using a battery with a charger system. The charger input lines may be used as power inputs if a battery is not used (determined by the position of the switch)..</p> <p>The battery connector (J15) is dedicated for an internal 12 V lead-acid battery configuration. When this configuration is used, the jumper (J16) must be set on pins 1 and 2. When J16 is set this way, it is mandatory that that J17 (EXT) be connected to an ABB Totalflow-approved charging source.</p>
Charger (J17)	<p>Only use an ABB Totalflow-approved charging source when configured for internal 12 V lead-acid battery (J16 1 and 2). The input can be 9-30 Vdc VBATT on J17</p> <p>WARNING: Power at J17 (up to 30 Vdc) is applied to the Communication connector terminals as power for radios, etc. Radio operation and the Inhibit feature may not work properly if other than a nominal 12 Vdc power source is used.</p>
External Power (J7)	<p>When supplying external 9-30 Vdc power to EXT (J17) (no internal 12 V lead-acid battery), no connection should be made to J15. The jumper on J16 should be set to 2 and 3. This will override the lead-acid charge controller.</p>
Memory	<ul style="list-style-type: none"> Application (Totalflow.exe) runs out of 32M SRAM. RAM memory has lithium backup battery. This is engine card specific. Refer to the corresponding data sheet (part # 2104499-xxx).

Component	Description
	<ul style="list-style-type: none"> Application and configuration files permanently stored in 64M Flash. This is engine card specific. Refer to the corresponding data sheet (part # 2104499-xxx). Registry (MAC address, etc.) is stored in 256 byte E²PROMSD card. This is engine card specific. Refer to the corresponding data sheet (part # 2104499-xxx). SD card (optional) (1G)
Comm. Ports	<ul style="list-style-type: none"> One (1) onboard serial port for remote communications, software configurable: RS-232/RS-485/RS-422. WARNING: If the unit is powered externally, 9-30 Vdc, the external power will be present on pins 1 and 3 (switched power) on COMM 1 (J10). The auxiliary equipment connected to J10 should be capable of operating from the externally supplied Vdc range. One (1) RS-232 for local PCCU connection (J9) One (1) Ethernet (10 BaseT) (J1) USB host/device port Optional: <ul style="list-style-type: none"> One (1) USB device port and/or one (1) USB Host port. Requires use of USB Adapter cable.
Digital Input	One (1) DI/PI capable of 10 kHz (J12)
Digital Output	One (1) DO (J13)
I/O Interface	Optional plug-in I/O daughter card.
LCD Interface	2 line by 24 character LCD with temperature compensation circuitry
Security Switch	On/Off bi-level (application specific) onboard security
I/O Scan Rate	Application specific. See corresponding software specification.
Time Base Stability	This is engine card specific. See corresponding data sheet (part # 2104499-xxx).

1.2.2.1 Onboard I/O

The μ FLO^{G4} provides the following I/O:

- One (1) DO
- One (1) DI/PI

Digital Input (DI/PI)

The μ FLO^{G4} provides one digital/pulse input as a means to monitor external equipment.



CAUTION When connecting or disconnecting any wires to the μ FLO^{G4} board, the user should remove all power sources and ensure that they are properly grounded.

The digital input reads an external contact. The device's state of ON or OFF is application specific. See the PCCU32 help files for additional information.

DI Electrical Specifications (Each Point)

- Open circuit voltage: 5 Vdc (internally pulled up to 5 Vdc nom.).
- Short circuit leakage current: -395 μ A typical.
- Input capacitance: 0.1 μ F typical.
- Maximum allowable voltage range on input: -0.5 Vdc to 30 Vdc.

- Maximum frequency input: 100 Hz @ 50% duty cycle with de-bounce enabled. 10 kHz @ 50% duty cycle with de-bounce disabled.

Input Specifications

- Dry contact (form A), Open Collector or Active Voltage.
- Minimum contact resistance to activate input 1000Ω.
- Voltage threshold to deactivate the input 3.1 V (referenced to GND terminal).
- Voltage threshold to activate the input: 0.5 V (referenced to GND terminal).
- Conductor pairs must be shielded to prevent spurious signals.

Typical DI Point Schematic

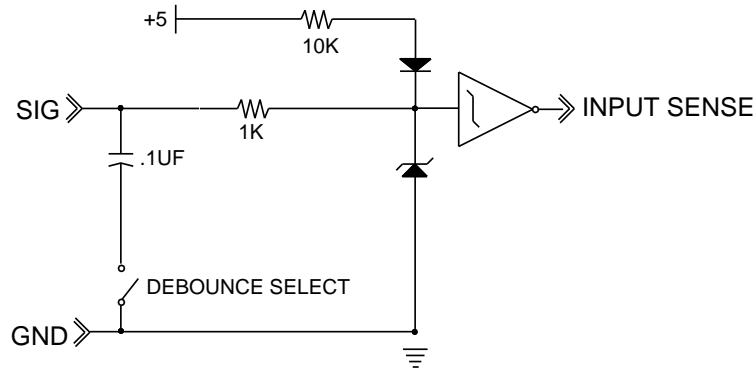

Figure 1-7 Typical Point Schematic

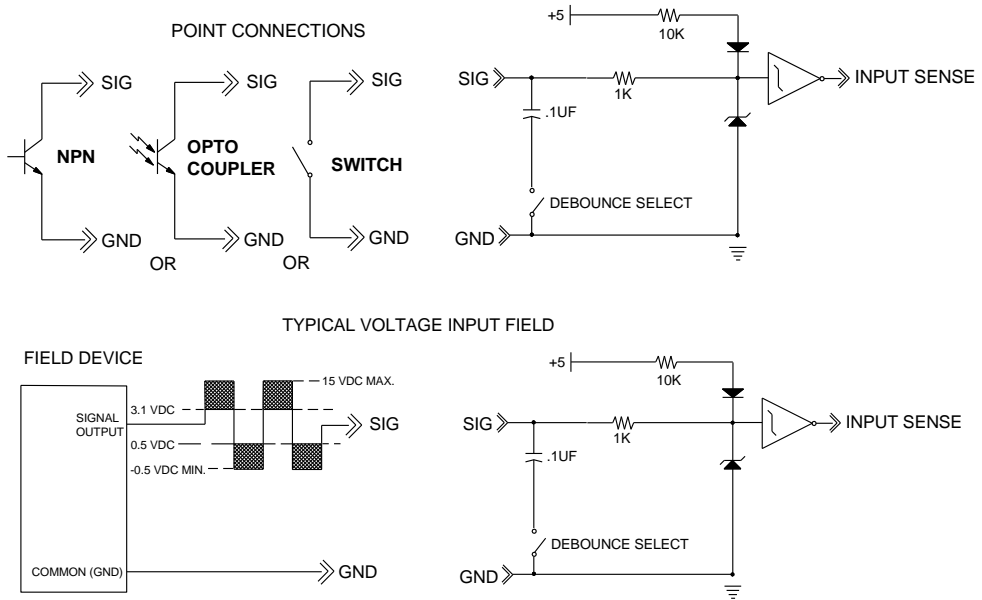



Figure 1-8 Example Connections

Digital Output

The μFLOG⁴ provides one (1) digital output as a means to control external equipment. The digital output provides a ground for the external device.

CAUTION  When connecting or disconnecting any wires to the μ FLO^{G4} board, the user should be properly grounded and remove all power sources.

The use of the DO is application specific. See the application specification for further information.

Electrical Specification (Each Point)

- Open circuit voltage 0 Vdc
- Short circuit leakage current 0 μ A typical
- Output capacitance 1000 PF typical
- Maximum allowable voltage range on output 0 Vdc to a maximum of 30 Vdc

Output Specification @ 23°C

- Open drain FET type
- ON resistance (including PTC fuse resistance) 0.22 Ω typical
- Maximum pulse current 3 A for five (5) seconds
- Maximum continuous sink current. Must de-rate above 23°C. Maximum continuous sink current 1 A @ 70°C, 0.85 @ 85°C 1.85 A

Typical DO Point Schematic

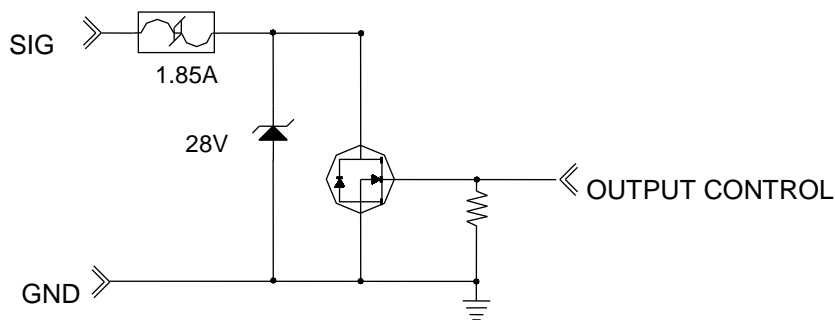

Figure 1-9 Typical Point Schematic

TYPICAL SINK OUTPUT FIELD WIRING

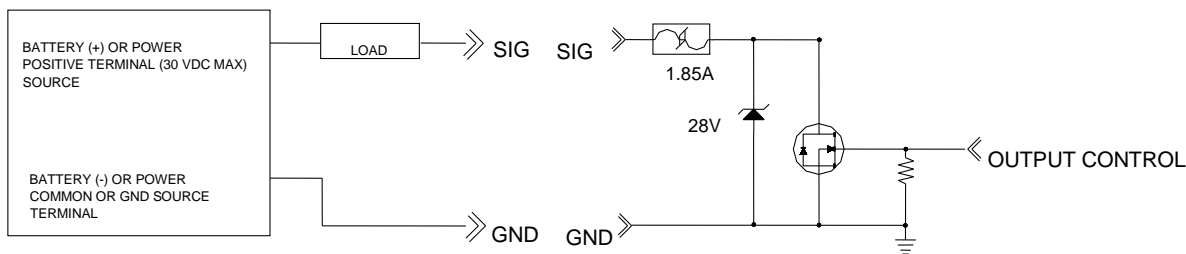

Figure 1-10 Example Connections

1.2.3 Engine Card

An engine card plugs into the μ FLO^{G4} board. All processor and memory components and communication circuitry reside on this engine card. The engine card is application specific. Please see the data sheet (part # 2104499-xxx) for the minimum hardware requirements.

It should be noted that removing the engine card will result in a loss of data in the battery-back up RAM.

1.2.4 Integral Multivariable Transducer (IMV)

The Integral Multi-Variable Transducer (IMV) contains circuitry for analog-to-digital processing and provides the primary measurement capability for the μ FLO^{G4}. The unit is designed to provide EMI/RFI protection when the motherboard and RF gasket are installed properly and to protect the circuitry from other environmental effects. The IMV contains a single circuit stamp board that contains the analog-to-digital converter and analog conditioning circuitry necessary for the IMV and the RTD (see Table 1-4).

The IMV is characterized over temperature so that any changes occurring in the IMV or in the electronics can be compensated.

The IMV always measures static pressure on the high side. The IMV can be ordered from the factory with the IMV unit rotated in the meter enclosure; however, this is only offered as an aid to the mechanical installation process. Static pressure is still measured on the high pressure side (refers to DP only).

Table 1-4 IMV Specifications

Item	Description
Temperature Limits	Compensated: -20°F to 140°F (-29°C to 60°C) Operational: -40°F to 185°F (-40°C to 85°C) Storage: -40°F to 185°F (-40°C to 85°C)
Analog to Digital	24-bit maximum resolution (0.000012% FS)
Resolution	24-bit analog-to-digital conversion (0.000012% FS) (0.000053% FS effective measurement resolution – Minden units only)
Vibration Performance	1.5 INW per G (2G maximum) at 1 Hz, decreasing to zero (0) at 1 kHz
Mounting Specification	Change from perpendicular (front to back/around X-axis) will be $\leq 0.5\%$ URL. This can be corrected with calibration.
Static Pressure	
Accuracy	Includes the effects of linearity, hysteresis and repeatability at reference conditions: Standard Accuracy: $\pm 0.075\%$ of user calibrated spans from 20% to 100% of URL
Ambient Temperature Effect Within the Operational Temperature Limit	$\pm 0.075\%$ of URL $\pm 0.06\%$ of reading
Stability	$\pm 0.1\%$ of URL (for 12 months)

Differential Pressure	
Accuracy	Includes the effects of linearity, hysteresis and repeatability at reference conditions: Standard Accuracy: $\pm 0.075\%$ of user calibrated spans from 20% to 100% of URL
Ambient Temperature Effect Within the Operational Temperature Limit	$\pm 0.075\%$ of URL $\pm 0.06\%$ of reading
Stability	$\pm 0.1\%$ of URL (for 12 months)
SP Effect	DP Zero per 1500 psi: $\pm 0.03\%$ of URL DP Span per 1500 psi: $\pm 0.1\%$ of reading
Temperature	
Process Range	-80°F to +750°F (-62°C to 399°C)
Accuracy (As Shipped From the Factory)	$\pm 0.2^\circ\text{F}$ ($\pm 0.12^\circ\text{C}$) over operating range

1.2.5 Optional I/O Card

Please refer to the corresponding data sheet (part # 2104499-xxx) for specific performance characteristics and available options.

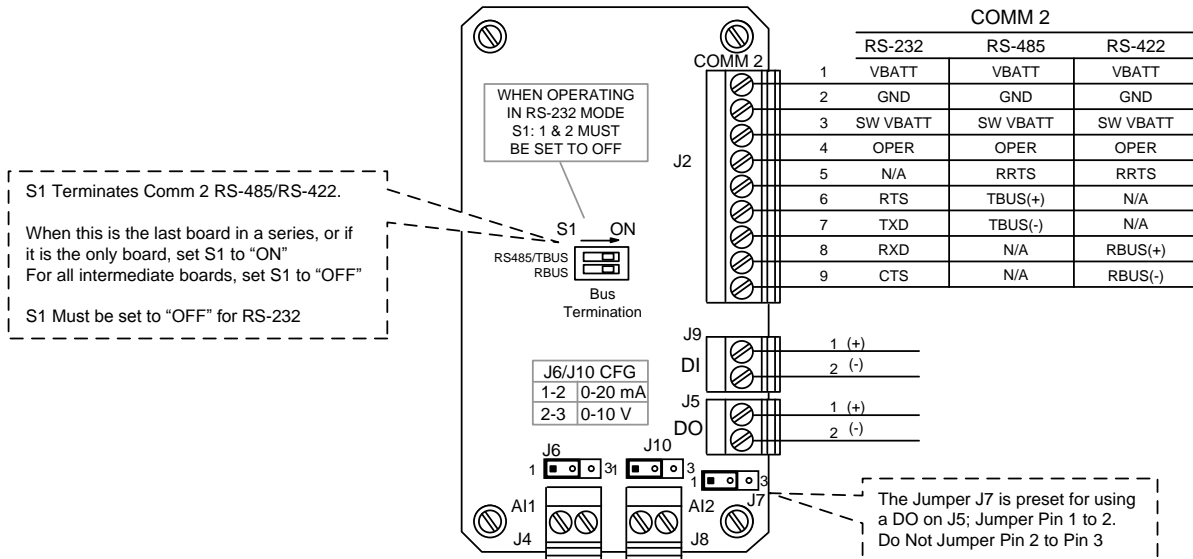

Figure 1-11 Optional I/O Card

1.2.6 Resistive Temperature Detector (RTD)

An optional, 100-Ω, platinum RTD (.000385 Alpha) measures real-time flowing temperature of the process gas. The standard RTD is provided with a 10-foot cable. Other lengths are available upon request.

1.2.7 Solar Panel

The μ FLO^{G4} can be used for an optional 10-Watt, 20-Watt or 30-Watt solar panel. The panels are designed to be mounted on a 2-inch extension pipe or on top of or to the side of a meter house.

1.3 μ FLO^{G4} Application Licensing

The μ FLO^{G4} offers the user unrivaled power and flexibility. The μ FLO^{G4} unit can support far more applications than the previous μ FLO. Various applications require that ABB Totalflow pay a royalty to third party vendors. As such, ABB Totalflow has developed a credit system for handling application loads beyond what would be required for a typical G3 meter run. Application credits are required to enable many of the applications.

From the factory, the μ FLO^{G4} has one (1) general credit installed.

Applications are divided into categories: Standard, General, IEC and CO2. Other application categories may be created in the future.

Standard applications typically support the general applications as well as the basic operation of the μ FLO^{G4} unit. Standard applications do not require any credits to be enabled.

Standard applications include:

- System Application
- Communications
- I/O Subsystem
- Pulse Accumulator
- Operations
- Holding Registers
- Units Conversion
- Host Interface
- Displays

General applications typically provide some type of measurement, control, logging and/or archival function. General applications include:

- AGA-3 Measurement
- AGA-7 Measurement
- V-Cone Measurement
- Coriolis Gas
- Alarm System
- Shutdown

CO2 (NIST) applications require a CO2 (NIST) credit.

1.3.1 Credit Key (USB)

The μ FLO^{G4} comes with one (1) general credit installed on the unit. If the system configuration requires more application credits, they can be purchased from ABB Totalflow's Order Entry (1-800-442-3097).

Credits (Standard, General, IEC and CO2) are maintained on the credit key. Credits can be purchased and kept on the USB credit key. The credit key is a secure USB Flash drive (i.e., thumb drive). It cannot be written to or read by any

program other than PCCU32 7.0 or later. Credits can be added to the credit key via a phone call to ABB Totalflow Technical Support. Again, these credits are used to run the various applications available in the G4 product line.

Credits can be transferred between the laptop and the μ FLO^{G4}. If a μ FLO^{G4} has extra credits (more than required to be fully licensed), the extra credits can be downloaded to the credit key to be used on other G4 units.

FYI  If the μ FLO^{G4} is running an unlicensed application, this is reflected in any reports generated from that unlicensed meter. The meter also logs the fact that it is unlicensed in the Event Log at the top of each contract day. Unlicensed applications cause the meter to connect more slowly.

1.4 Laptop Computer Running PCCU32

PCCU32 software running in a laptop Windows environment offers the user the most capabilities for programming the μ FLO^{G4}. The Windows environment features user-friendly help files and easy to follow menus.

If configured with the USB option, the laptop computer connects via the cable directly to the connector on the side of the μ FLO^{G4}. Once this physical connection has been made, the user may begin communicating through the software.

WARNING  Remove power from the device, or ensure that the area is known to be non-hazardous before removing the enclosure cover or making connections. For further information, refer to the certification drawing indicated on the device's name tag and national and local electrical codes.

FYI  Connecting to the μ FLO^{G4} with PCCU32 requires version 7.22 or later.

1.5 Local μ FLO^{G4} Connections

Making a local connection to the μ FLO^{G4} may be accomplished one of two ways. Traditionally, local connections have been made using the RS-232 PCCU cable with the round military connector on one end and a serial port connector on the other. The second method involves the local connection being made using a USB cable, Ethernet or optional, external USB Bluetooth adapter.

WARNING  Remove power from the device, or ensure that the area is known to be non-hazardous before removing any enclosure cover or making connections. For further information, refer to the certification drawing indicated on the device's name tag and national and local electrical codes.

1.5.1 Bluetooth Connectivity

With the μ FLO^{G4}, the user now has the option of performing a local connection using Bluetooth functionality. This option can be accessed through PCCU32.

1.5.2 RS-232 Serial PCCU Cable (Round Military Connector)

The local connection (serial military connector) requires an RS-232 serial port on the host computer (generally, a laptop). A PCCU cable is required to connect the host computer to the meter's round military connector. Connecting the PCCU

cable to the meter will cause an annunciator in the LCD to display an upper case letter “L” for local connect.

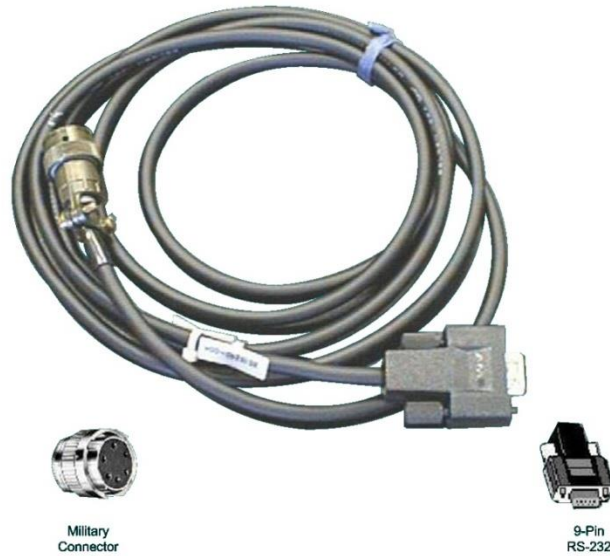



Figure 1-12 RS-232 Local Communication Cable

1.5.3 PCCU32 USB Connection

FYI  The USB local connection is optional and may be included when ordering or added later.

The local USB connection requires the use of a USB cable connected to the host computer (generally, a laptop). A USB PCCU cable is required to connect the host computer to the meter’s client connector. Connecting the PCCU cable to the meter will cause an annunciator in the LCD to display an upper case letter “L” for local connect.

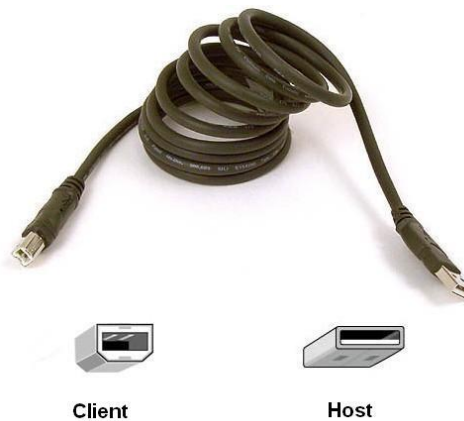

Figure 1-13 USB Local Communication Cable

1.6 Network Connectivity (Dynamic IP with Router)

When operating the μ FLO^{G4} in a network environment, using an Ethernet is a practical solution. PCCU32 communication with the meter over an Ethernet connection (TCP/IP) requires the use of a hub, switch or router along with appropriate cabling. Ethernet (local) communication may also be used for local PCCU connection. The cable and connection to the exterior of the enclosure is an option and may be included when ordering or added later.



Remove power from the device, or ensure that the area is known to be non-hazardous before removing any enclosure cover or making connections. For further information, refer to the certification drawing indicated on the device's name tag and national and local electrical codes.



Figure 1-14 Ethernet Communication Cable

2.0 INSTALLATION

This chapter provides the user with information for the installation and set up of the μ FLO^{G4}. By the time the user has finished this chapter, they will have the μ FLO^{G4} unpacked, installed, field wired and ready for operation. For a safe and trouble-free installation, follow all instructions and advisories.

FYI



Read through this chapter before beginning the installation. This will give the user the ability to plan their specific installation. Additionally, before beginning, refer to the wiring diagrams delivered with the μ FLO^{G4}. The user can store these drawings under the Drawing tab in the back of the manual.

2.1 Unpacking and Inspection

2.1.1 Unpacking

The μ FLO^{G4} and RTD are shipped separately in specially designed shipping cartons which contain the unit, mounting brackets, parts list and wiring and interconnect diagrams. The solar panel and the battery pack, with applicable hardware, are shipped in a separate carton.

Carefully remove the items from each carton.

2.1.2 Inspection

- Inspect the shipping carton for damage. If the shipping carton is damaged, keep it until the contents have been inspected for damage.
- Inspect the unit's exterior for dents, chipped paint, etc.
- Inspect the LCD window for breakage.
- Visually inspect the electronic boards, cables and other components for damage.

2.1.3 Damaged Components

If any components have been damaged or if there are noticeable defects, notify the ABB Totalflow representative. Keep all shipping materials for the carrier's inspection. ABB Totalflow will arrange for immediate repair or replacement. See the Getting Help section at the beginning of the manual.

2.2 Installation Overview

The μ FLO^{G4} can either be pipe, direct or wall mounted. The user will need to decide which installation scenario best suits their needs and then use the corresponding procedures. Figure 2-1 shows a typical pipe mount installation.

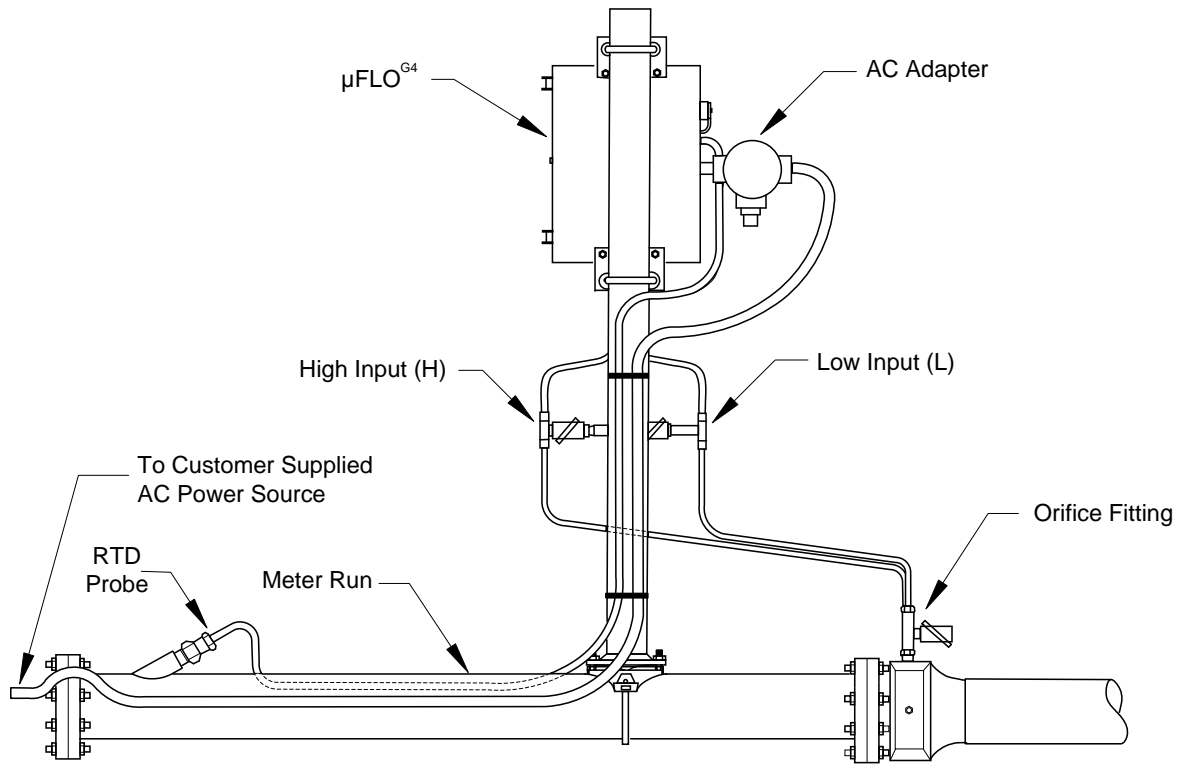

Figure 2-1 Typical Pipe Installation

2.3 Pipe Mount Installation

The following steps detail the procedures for installing the $\mu\text{FLO}^{\text{G4}}$ directly to the meter run. Before beginning, review the procedure and the materials required for installation.

2.3.1 Materials Supplied

- Two (2) U-bolts plus fastening hardware
- $\mu\text{FLO}^{\text{G4}}$ mounting brackets

2.3.2 Materials Not Supplied

- One (1) pipe saddle
- One (1) 2" x 40" pipe
- Standard 3 or 5 valve manifold
- Stainless steel tubing

FYI



Optional equipment can be ordered from ABB Totalflow.

2.3.3 Step-by-Step Instructions

FYI



To install the $\mu\text{FLO}^{\text{G4}}$, it is recommended that two people perform the installation. One to hold the unit in position and the other to install and tighten the mounting brackets.

- 1) Position the pipe saddle on the meter run. Select a location that allows easy user access and is close to the lines. The lines should be as short as possible.
- 2) Temporarily attach the saddle on the meter run pipe. Use the U-bolt and associated hardware.
- 3) Screw the 2" by 40" mounting pipe into the saddle. Place a level against the pipe, and vertically align. Adjust the pipe until vertical alignment is achieved.
- 4) After vertical alignment, securely tighten the 2" by 40" pipe into the saddle. Once completed, securely tighten the saddle mounting bolts. Be certain the pipe is securely installed in the saddle.

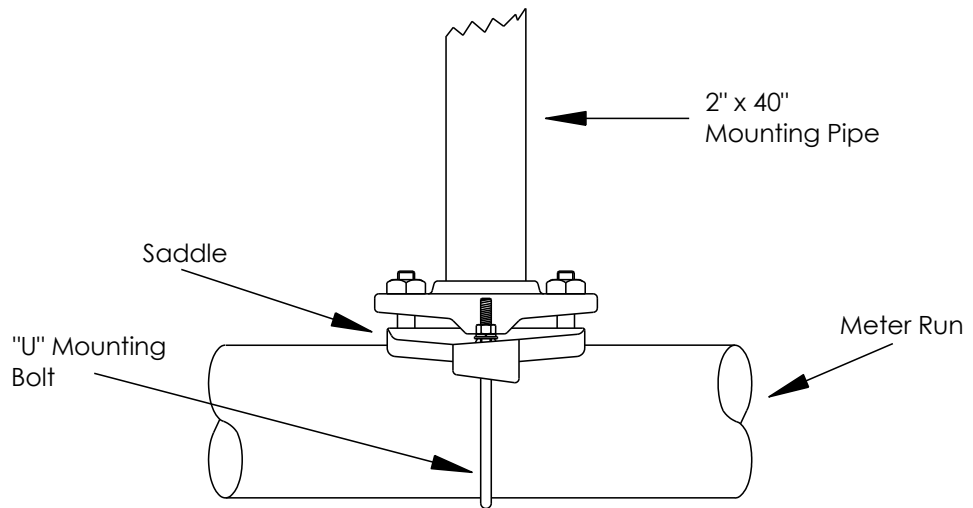

Figure 2-2 Typical Pipe Saddle Installation

- 5) Position the μ FLO^{G4} on the 2" mounting pipe, and secure in place with the two U-bolts, flat washers, lock washers and two 9/16" bolts.

FYI



Position the μ FLO^{G4} high enough to allow slope from the externally mounted manifold to tap valves.

2.4 Wall Mount Installation

If the user is installing the device to a wall near the meter run or inside a meter shed, use the following procedure. Before beginning, review the procedure and the materials required for installation.

2.4.1 Optionally Supplied Materials

- μ FLO^{G4} mounting brackets

2.4.2 Materials Not Supplied

- Four (4) 1/4" bolts long enough to extend through mounting wall
- Standard 3 or 5 valve manifold or static pressure tap valve
- 3/8-inch stainless steel tubing
- 1/4" x 3/8" tubing fittings

CAUTION

If the μ FLO^{G4} is to be wall mounted, the wall itself should have sufficient strength to support the hanging weight of the unit.

There should be no obstruction(s) that would prevent the μ FLO^{G4} door from being opened to access the interior installed components or to interfere with the installation of the solar panel.

2.4.3 Step-by-Step Instructions

- 1) Drill the mounting holes in the wall supports.
- 2) Install the supplied wall-mounting brackets on the back of the μ FLO^{G4}.
- 3) Lift and align the μ FLO^{G4} wall-mounting brackets with the mounting holes drilled in the wall.
- 4) Insert the 1/4" bolts through the μ FLO^{G4} mounting brackets and into the wall. Securely tighten all bolts to attach the unit to the wall.

FYI

Position the μ FLO^{G4} high enough on the wall to allow slope from the externally mounted manifold to tap valves.

2.5 Direct Mount Installation

If the user is installing the μ FLO^{G4} directly to an instrument manifold, use the following procedure. Before beginning review the procedure.

FYI

All the required hardware for mounting the μ FLO^{G4} to the manifold is to be supplied by the customer.

2.5.1 Step-by-Step Instructions

- 1) Attach the Integral Multi-Variable (IMV) to the manifold. Before aligning with the manifold, ensure that the Teflon seal rings are in place around the two process ports.
- 2) Using the four 7/16-inch bolts supplied with the manifold, secure the IMV to the manifold (see Figure 2-3).

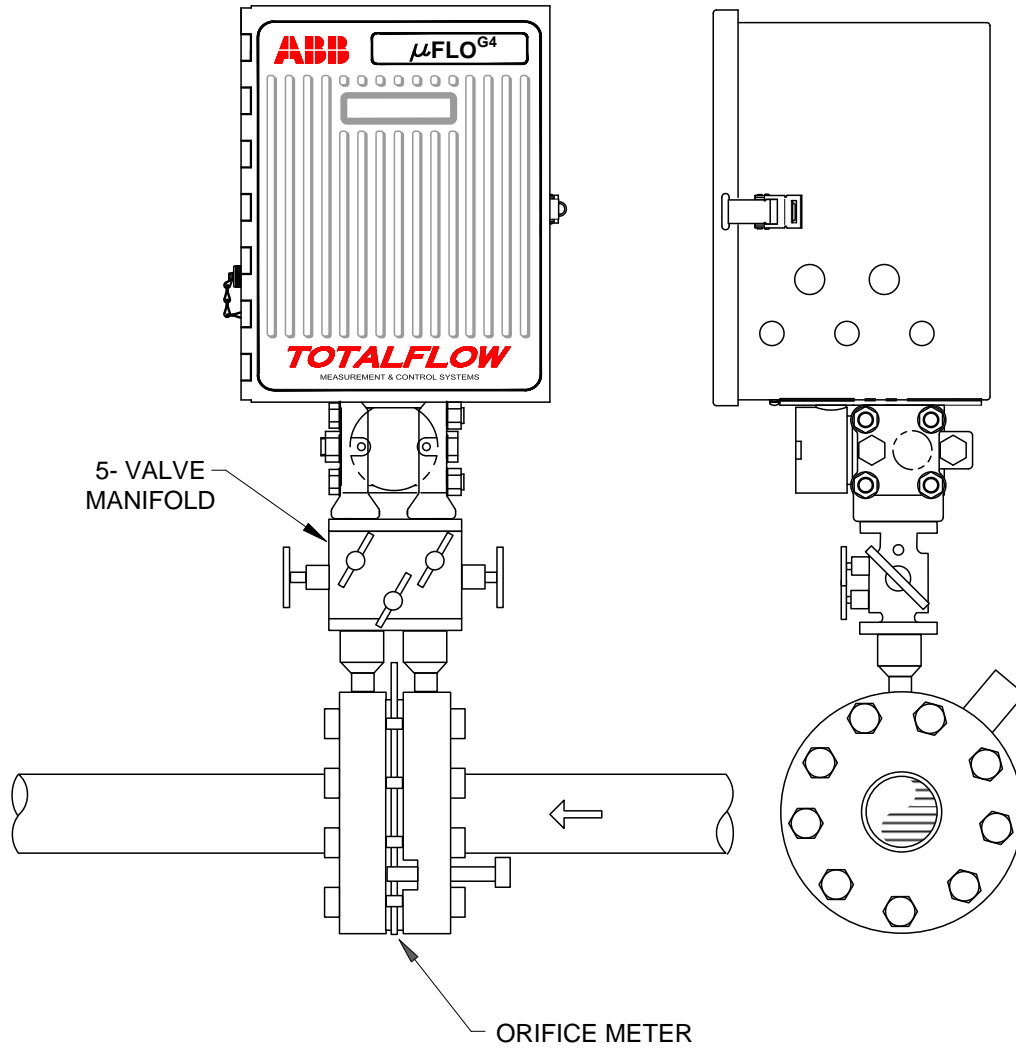

Figure 2-3 μ FLO^{G4} Direct Mounted

2.6 Manifold Input Lines

The following procedure will provide the user with the necessary steps to install the manifold. The meter run manifold high (H) and low (L) pressures terminate in the μ FLO^{G4} H and L differential port cells. Differential port cells are located on the bottom of the μ FLO^{G4} (see Figure 2-4). The installation is the customer's responsibility.

2.6.1 Materials Not Supplied

- Stainless steel tubing
- Tubing fittings



A backup wrench should always be used when working with stainless steel tubing and valves. This prevents the fitting from turning and/or placing tension on the stainless steel tubing.

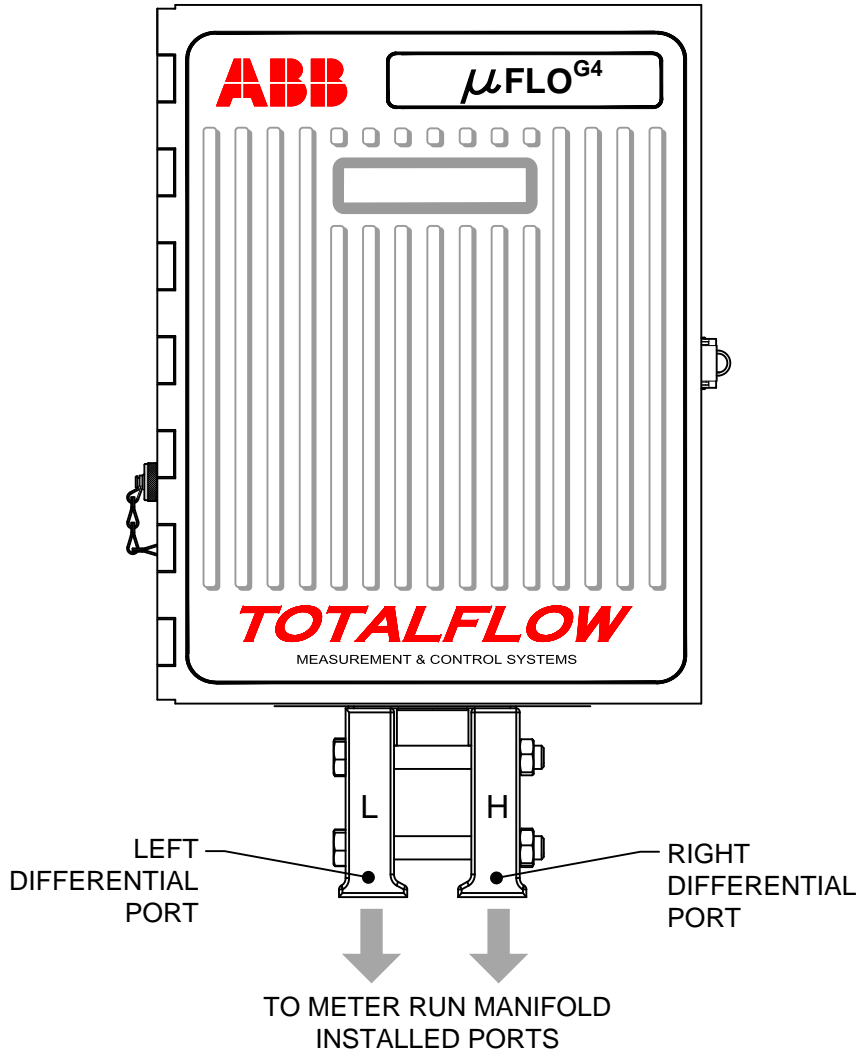



Figure 2-4 Transducer Low and High Side Ports

2.6.2 Step-by-Step Instructions

- 1) Install the isolation valves on the meter run (if using a 3 or 5 way manifold)
- 2) Install the manifold and tubing to the meter run and the $\mu\text{FLO}^{\text{G4}}$.

FYI  The manifold to $\mu\text{FLO}^{\text{G4}}$ fittings are not supplied with the $\mu\text{FLO}^{\text{G4}}$.

- 3) Leak check all connections.

TIP  Leaks in the tubing or manifold will introduce errors when calibrating IMVs.

2.7 Battery Pack Installation

A battery pack provides the μ FLO^{G4} with its operating power. The battery is packed and shipped separately. Before installation, inspect the power cables where they terminate on the battery pack and the connectors for breakage.

2.7.1 Step-by-Step Instructions

- 1) Open the μ FLO^{G4} hinged door. Insert the battery pack (wires attached by manufacturer) into the compartment. Ensure that the battery terminals are not touching either the keeper lip on the shelf or any metal surface inside of the unit.
- 2) Connect the battery pack connector to the μ FLO^{G4} board's battery connection, J15 (see Figure 2-5).
- 3) Next, the user must verify the jumper at J16 is across pins 1 & 2 (default).
- 4) Observe the LCD. The display should be on and scrolling through the startup diagnostics sequence.

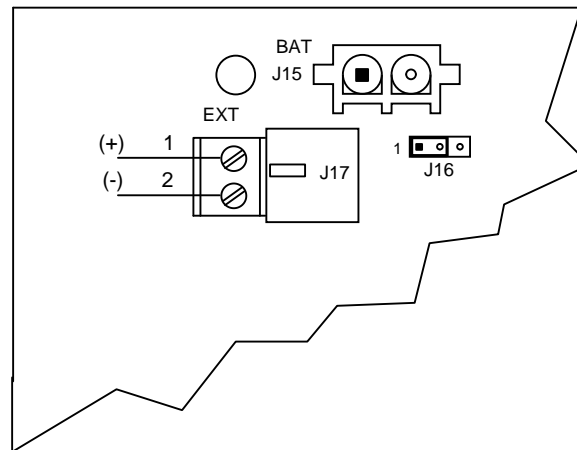

Figure 2-5 μ FLO^{G4} Board Battery and Charger Input Connections

2.8 Lithium Battery Installation

The following are the steps for installing and verifying the connection on the lithium battery. The lithium battery is not connected when shipped from the factory. The user will need to connect the battery before continuing.

- 1) To connect the battery, open the enclosure. The lithium connector (J18) is located on the μ FLO^{G4} board (see Figure 2-6).
- 2) On the μ FLO^{G4} board, the lithium (+) red is the top (pin 1) and the (-) black (pin 4) is on the bottom. Attach the lithium battery connector to J18.

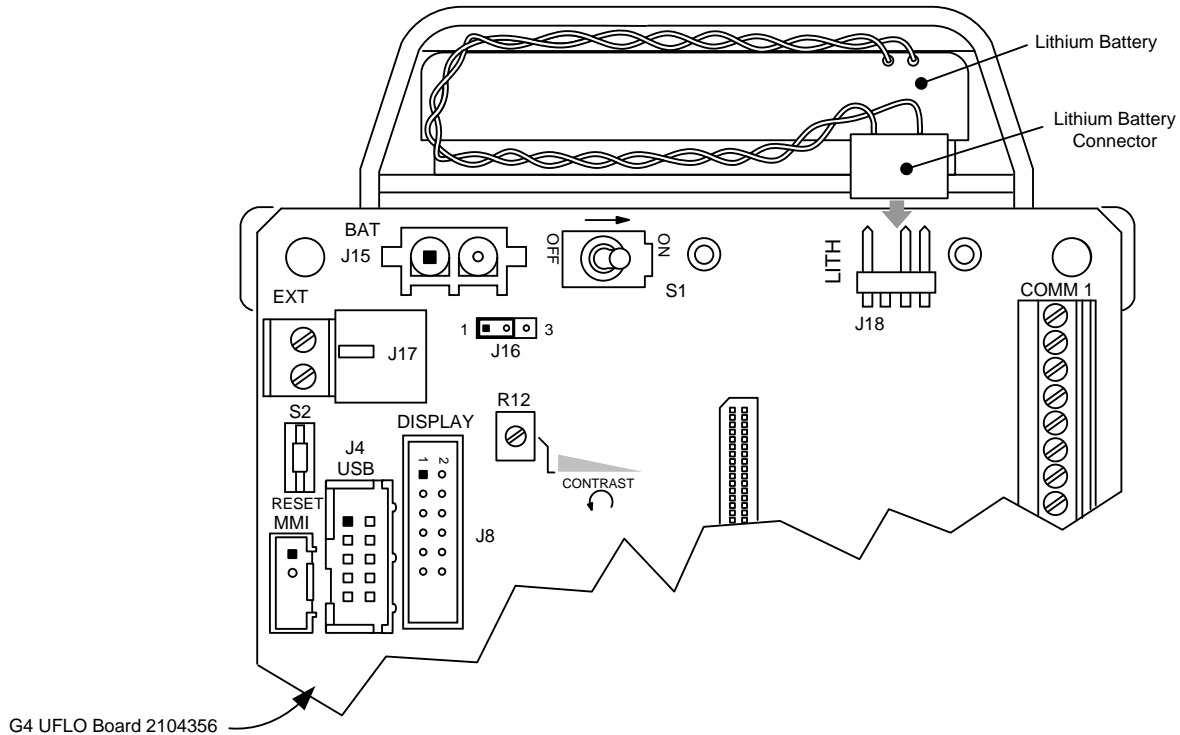

Figure 2-6 Lithium Battery

2.9 Solar Panel Installation

The solar panel is designed for outdoor mounting on a 2" extension pipe. This is installed on the upper end of the μ FLO^{G4} 40" mounting pipe (see Figure 2-7). The solar panel must be mounted within 12 feet of the μ FLO^{G4} (other lengths are available). For a wall-mounted μ FLO^{G4}, it can be mounted on the top of or the side of the meter house.



WARNING

Electrical wiring must be installed according to requirements for the area classification. For further information, refer to the certification drawing indicated on the device's name tag and national and local electrical codes.



CAUTION

Do not connect the solar panel power cable to the μ FLO^{G4} unless the main battery pack has been connected to J15 and the J16 jumper has been set across pins 1 and 2 (see Figure 2-5).



FYI

If the installation procedures are required for mounting the solar panel on the top or the side of the meter house, the customer should contact ABB Totalflow's Service department. See the Getting Help section in the Introduction chapter within this manual.

2.9.1 Materials Supplied

- One solar panel
- Two (2) U-bolts and fastening hardware
- Solar panel cable (standard is 12"; other lengths are available)
- Solar panel mounting bracket (if not already attached to the solar panel)

2.9.2 Materials Not Supplied

- Cable ties
- One (1) 9-inch extension of the 2-inch pipe or other suitable length of pipe, threaded on one end
- One (1) 2-inch coupling

FYI



Exercise caution when installing the solar panel so as not to damage it. When mounted, the solar panel will face up from the horizon at a 50° angle.

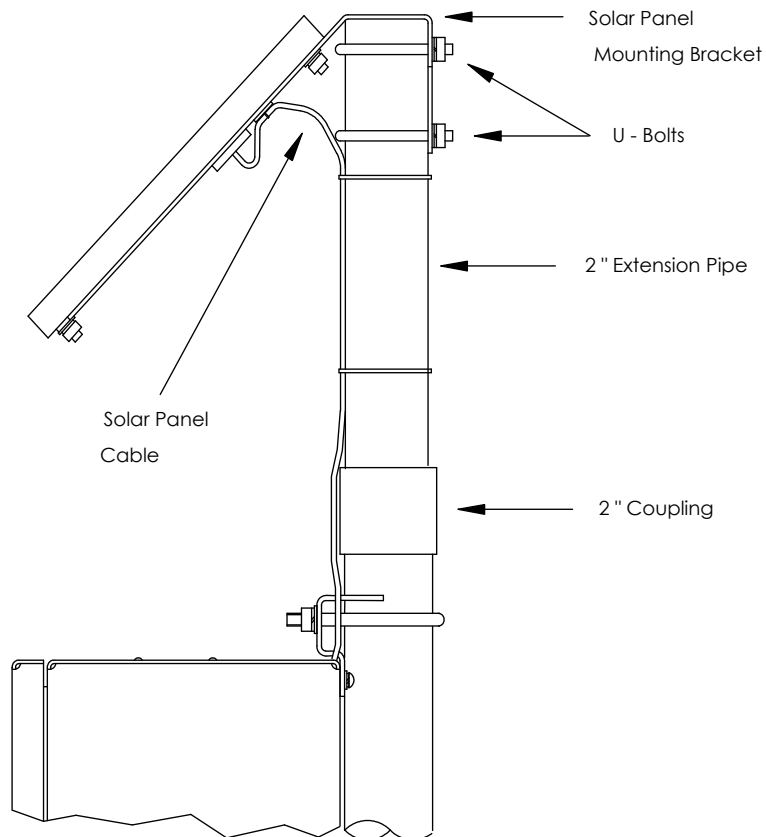

Figure 2-7 Typical Solar Panel Installation

2.9.3 Step-by-Step Instructions

- 1) Attach the 2" pipe coupling to the top end of the μ FLO^{G4} 40" mounting pipe. Securely tighten.
- 2) Install the 2" pipe extension into the coupling. Securely tighten.
- 3) Check the solar panel using the digital voltmeter to verify polarity and output voltage. Voltage will vary depending on the amount of sun, angle to the sun, etc.
- 4) Install the solar panel on the mounting bracket with the provided hardware, if required.



DO NOT connect the other end of the solar panel to the μ FLO^{G4} until instructed to do so.

- 5) Attach the solar panel mounting plate to the top end of the 2" extension pipe with the U-bolts and associated mounting hardware. Do not tighten the U-bolts until the solar panel has been correctly positioned.
- 6) For northern hemispheres, position the solar panel facing south. For southern hemispheres, position the solar panel facing north. For optimum charging, the solar panel should not be in the shadows for the majority of the day. The panel should be kept clean for maximum charging.
- 7) Remove the CHGR Input terminal block (J17) from the μ FLO^{G4} board. Insert the solar panel power cable through an access hole on the side of the case. Allow enough power cable for field wiring to the CHGR Input +/- terminations on J17.
- 8) Before making connections to the terminal block, trim the wire ends back 1/4". Loosen the terminal block securing screws, and insert the wire. Upon completion, retighten. Connect the solar panel (+) lead to the (+) terminal and the (-) wire to the (-) terminal (see Figure 2-5). Verify the main battery pack is connected and that the J16 jumper is set to pins 1 and 2. When finished, reinstall the terminal block with wires attached.
- 9) Following the connection of the solar panel power cable, secure the cable to the 2" extension pipe and the mounting pipe cable with plastic tie-wraps.

2.10 External Power to the μ FLO^{G4} Board (9-30 Vdc)

The following procedure will walk the user through the steps of wiring an external power source to the μ FLO^{G4} board.



Power at J17 (up to 30 Vdc) is applied to the Communication connector terminals as power for radios, etc. Radio operation and the Inhibit feature may not work properly if other than a nominal 12 Vdc power source is used. When connected to supply voltage less than 12 Vdc nominal, Sleep Mode voltage must be adjusted to equal to or less than supply voltage.



Electrical wiring must be installed according to requirements for the area classification. For further information, refer to the certification drawing indicated on the device's name tag and national and local electrical codes.



All peripherals must comply with the external power voltage range.



If a battery is connected to J15, 30 Vdc should not be applied to J17.

2.10.1 Step-by-Step Instructions

- 1) Set the jumper at J16 across pins 2 & 3.
- 2) Wire the external power source to the μ FLO^{G4} board, J17 (see Figure 2-8).
- 3) Observe the LCD. The display should be on and scrolling through the startup diagnostics sequence.

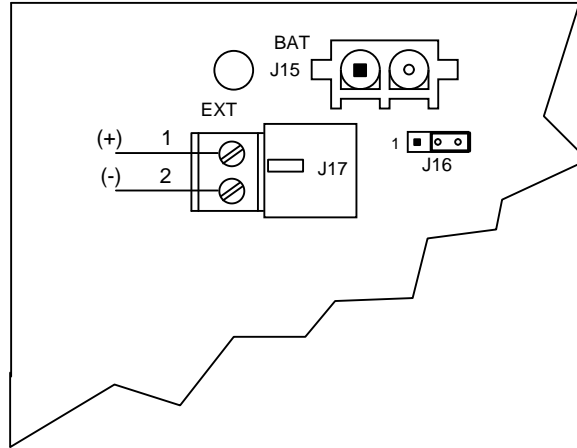

Figure 2-8 External Power to μ FLO^{G4} Board

2.11 RTD Probe Installation

The standard RTD measures the flowing. The following procedure will enable the user to install the RTD into the meter run.



Electrical wiring must be installed according to requirements for the area classification. For further information, refer to the certification drawing indicated on the device's name tag and national and local electrical codes.

2.11.1 Optionally Supplied Materials

- RTD probe with 10' of cable. Optional lengths are 15', 25', 30', 40' and 50'.
- One (1) thermowell with 3/4" npt threads. Optional threads are 1/2" and 1".
- Nylon tie wraps

2.11.2 Materials Not Supplied

- Customer must specify thermowell "U" length
- Teflon tape

2.11.3 Step-by-Step Instructions

- 1) Install the thermowell into the meter run.



Power should be removed from the μ FLO^{G4} before performing any field wiring.

- 2) Using the snap ring pliers, adjust the probe length so that it is spring loaded against the bottom of the thermowell.
- 3) Screw the probe connector into the thermowell (see Figure 2-9).

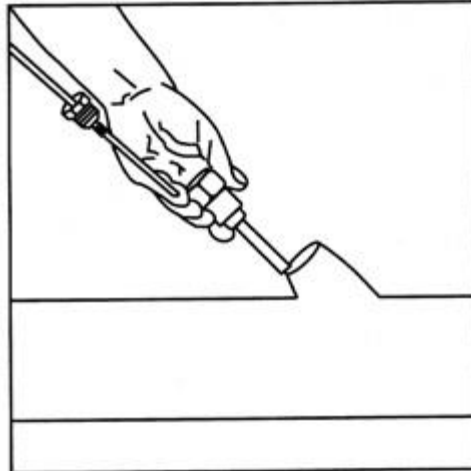

Figure 2-9 Thermowell Installation into Meter Run

- 4) Remove the nut from the water tight cord connector. Leave the nylon sealing ring in place.
- 5) On the μ FLO^{G4}, remove the hole plug from the unit. Upon completion, insert the wires through the hole. Allow enough RTD cable to extend into the μ FLO^{G4} for connecting wires to the RTD termination block, J3.
- 6) Secure the RTD probe cable using the supplied sealing ring and nut.



To prevent moisture from entering the μ FLO^{G4} after installing the RTD cord connector, be certain that the associated connector at the μ FLO^{G4} has a sealing ring and locking nut.

- 7) On the RTD probe wire, remove the spade lugs, if attached, and trim the wire ends back $\frac{1}{4}$ ".
- 8) Remove the associated terminal block from the μ FLO^{G4} board (J3). Loosen the terminal block securing screws, insert the wire and then retighten (see Figure 2-11).
- 9) Reinstall the terminal block with the wires attached.
- 10) Secure the cable to the meter run pipe with the plastic tie-wraps. **DO NOT** wrap the cable around the meter run pipe.

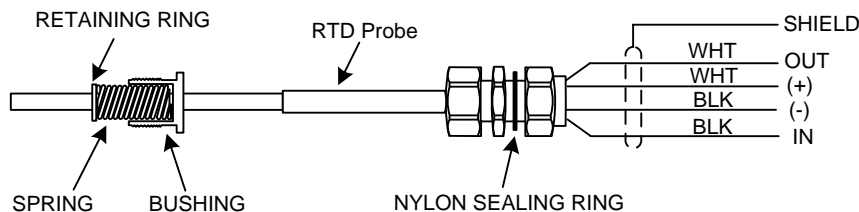

Figure 2-10 RTD Probe Wiring

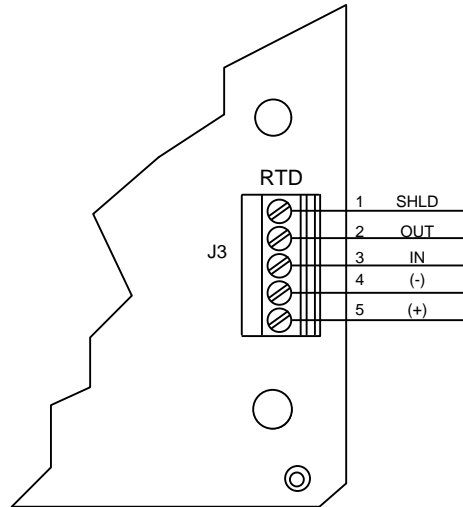

Figure 2-11 RTD Input Connections

2.12 AC Charging Unit Installation

The AC power charging unit maintains a constant voltage charge on the installed battery pack.



Electrical wiring must be installed according to requirements for the area classification. For further information, refer to the certification drawing indicated on the device's name tag and national and local electrical codes.

2.12.1 Materials Supplied

The following hardware is required to mount the AC power charging unit to the μ FLO^{G4}:

- AC charging unit
- Coupling nipple

2.12.2 Materials Not Supplied

- Plastic cable ties
- AC wiring, conduit (rigid or flexible)

2.12.3 Step-by-Step Instructions

The AC charging unit is shipped separately. When the unit is received, unpack and inspect all components for evidence of damage. Report any damage to the shipping carrier and to ABB Totalflow's Service department.

- 1) Remove one of the plugs from the side of the μ FLO^{G4} so that the AC charging unit can be mounted without obstruction.
- 2) Feed the AC charger's DC power lines into the μ FLO^{G4}. Allow for enough cable to extend into the unit for connection to the EXT CHGR +/- terminals.
- 3) Connect the AC charger unit to the μ FLO^{G4} using the supplied sealing ring and nut.



To prevent moisture from entering the μ FLO^{G4} after installing the AC battery pack charger unit, be certain that the associated connector at the charger unit has a metal-backed, sealing O-ring and metal locking nut attached.

- 4) Before connecting the charger wiring, trim the wire ends back $\frac{1}{4}$ ", and remove the associated EXT CHGR terminal block (J17) from the μ FLO^{G4} board.
- 5) Loosen the terminal block securing screws, and insert the red wire into the plus (+) terminal (top) and the black wire into the negative (-) terminal (bottom). Retighten the screws. Upon completion, reinstall the terminal block with the wires attached.
- 6) Plumb the conduit and associated AC wiring into the AC charger conduit box. Connect the 120 V hot and neutral or the two hot wires for 240 V to TB1 of the AC charger. Connect the ground wire to the green screw, T1.
- 7) Verify that the DC power wires are terminated properly inside the flow computer cabinet, and verify that the main battery pack is plugged into J15. Apply AC power to the AC charger.
- 8) Monitor the DC charging voltage by observing the μ FLO^{G4} display. The LCD should indicate: CHARGER 13.0 - 13.5 VOLTS.

2.13 μ FLO^{G4} Communication, Jumper Settings and Field Wiring

The μ FLO^{G4} main electronic board may require some basic set up and wiring. The standard μ FLO^{G4} enclosure enables the user to access the main μ FLO^{G4} board for the configuration of jumpers, communication modules and switches. All user wiring is wired directly to this board.

2.13.1 Communication Wiring

The user has the ability to program one (1) communication port on the μ FLO^{G4} board. COM 0 is the local port required for reading the μ FLO^{G4} with a laptop computer running PCCU32. COM 1 can be configured for any combination of RS-232, RS-485 or RS-422. For onboard communication wiring inside the standard μ FLO^{G4} enclosure, see Figure 2-12.

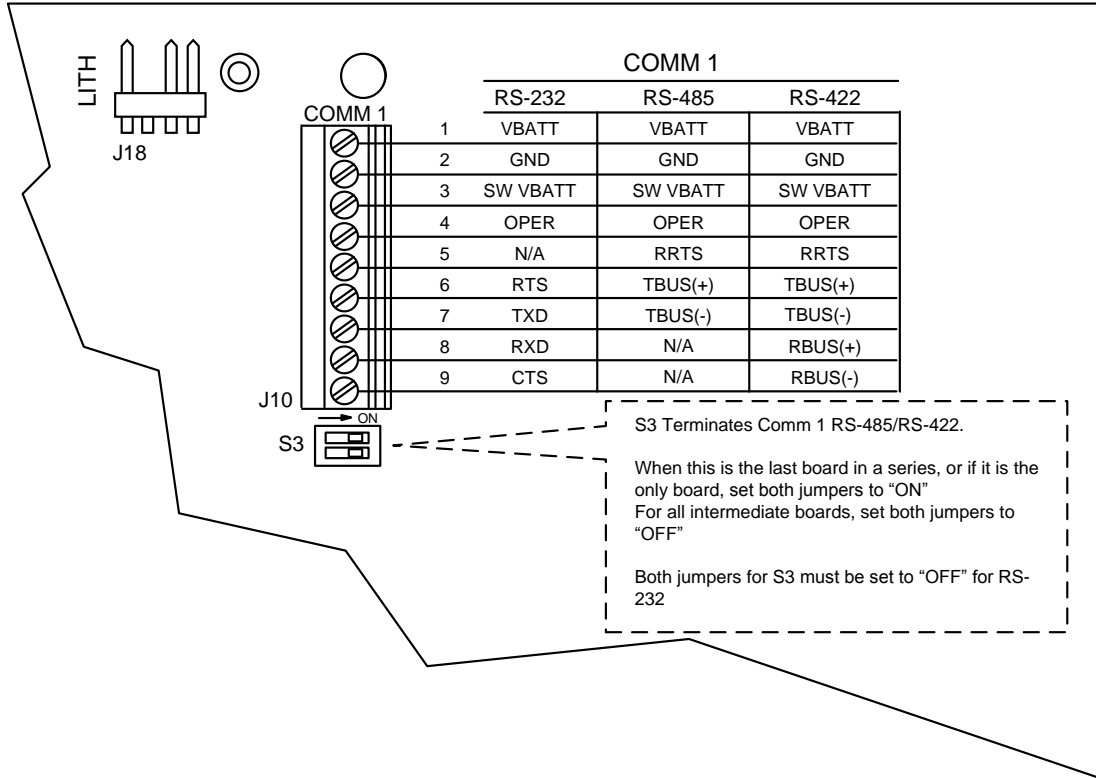

Figure 2-12 μFLO^{G4} Standard Communication Wiring



The μFLO^{G4} board, as with any electronic board, is susceptible to damage by static electricity or improper handling. To prevent this from occurring, the user should wear a grounding strap.

Remove power to the unit prior to changing the jumper settings or field wiring to the onboard I/O.

2.13.2 Board Configuration

The following offers a brief description of each configurable point on the μFLO^{G4} board and its function. The board diagram shows the location of these items (see Figure 2-13).

For other field wiring connections directly on the μFLO^{G4} board, use Table 2-1 and Figure 2-13.

Table 2-1 μFLO^{G4} Onboard Jumper Settings

Jumper No.	Description
S3	RS-485/RS-422/RS-232 Termination: When this is the last μFLO ^{G4} board in a series or if it is the only board, set S3 to ON. For all intermediate boards, set S3 to OFF. For RS-232, S3 must be set to OFF.
J16	Power Options: The jumper at J16 sets the power options. For solar and battery power, the user must set the jumper across pins 1 & 2. For external power, the user will need to set the jumper across pin 2 & 3. NOTE: When using the jumper in this configuration, wire the external power directly into the charger (J17). DO NOT CONNECT A BATTERY.

Jumper No.	Description
J14	DO: The J14 jumper is preset for using a DO on J13. Jumper pin 1 & 2. The user should not jumper pin 2 & pin 3.
S1	Security Switch: If the security switch is ON and a local connection is made to the unit via PCCU32, the proper security code must be entered. If the proper security code is not set up in PCCU32, the user will be unable to configure the μ FLO ^{G4} . If the security switch is turned OFF, the user will be able to configure the μ FLO ^{G4} without secure access.

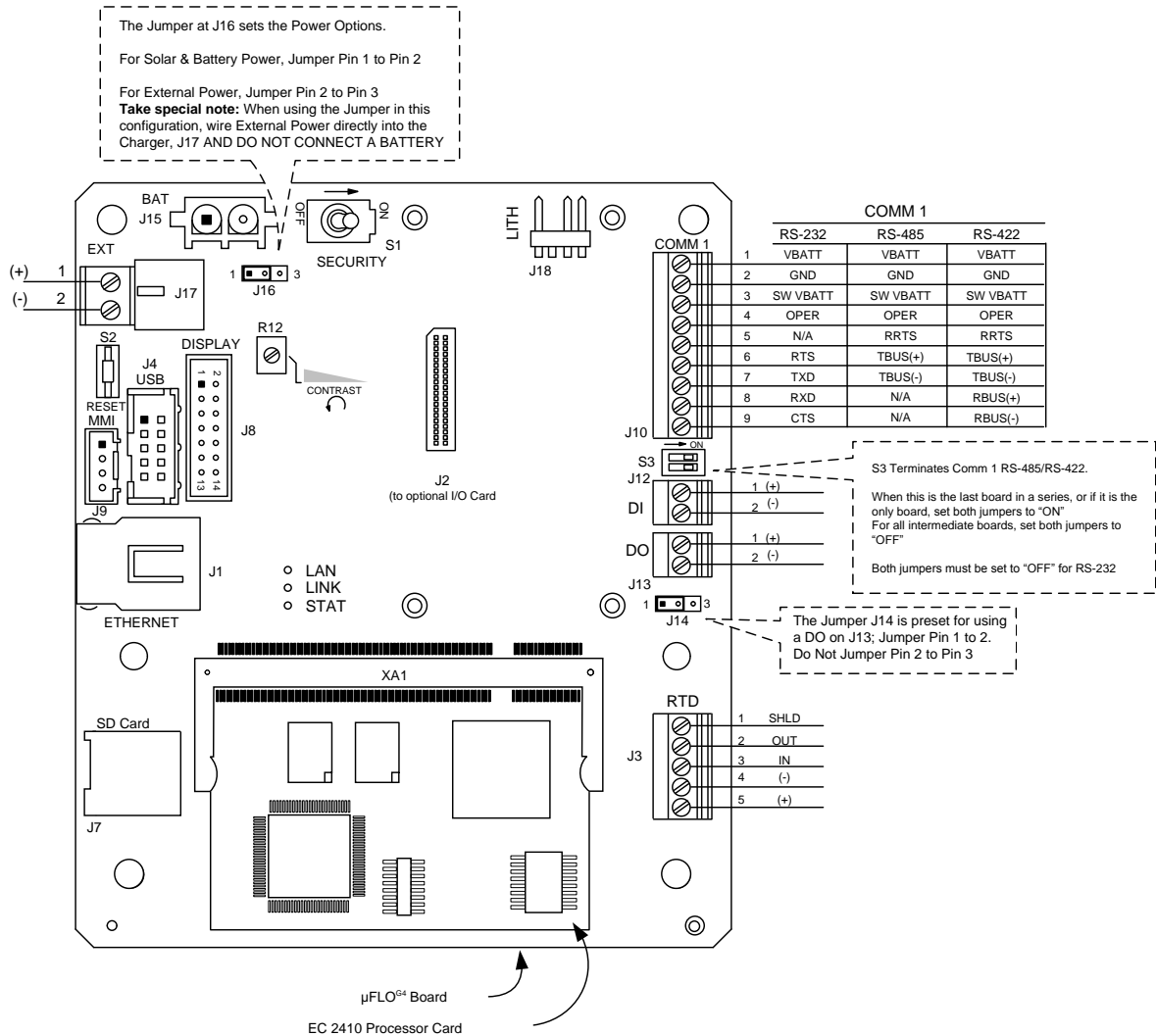

Figure 2-13 μ FLO^{G4} Main Board Configuration

3.0 STARTUP

3.1 Overview

The following chapter describes the steps required to get a newly installed μ FLO^{G4} system up and running. Specific information required to complete each step is also discussed in the PCCU32 help files.

FYI



Before beginning, the user should complete the tasks covered in Chapter 2.0 – Installation.

3.2 PCCU32 Installation and Setup

ABB Totalflow's PCCU32 7.22 (or later) software is required to communicate with the μ FLO^{G4}. Previous versions of PCCU32 are not compatible.

PCCU32 software running in a Windows environment offers the user the most capabilities for programming. The Windows environment features user-friendly help files and easy to follow menus. These menus and icons step the user through many of the required choices.

3.2.1 Step-by-Step Instructions

- 1) Insert the PCCU32 disk into the PC drive. If the CD is set to AutoPlay, the installation program should begin; otherwise go to Windows Start > Run. At the Run prompt, type D:\Disk1\setup.exe. D is the CD drive designation.
- 2) Follow the screen prompts as they during the installation.
- 3) A screen prompt displays asking for user information. Enter in the relevant information, and enter in the serial number in the appropriate space. The user needs to ensure that they enter both the numbers and dashes for the serial number.
- 4) Click the Next button.
- 5) Within the next screen, the user can change the default destination directory, if needed. Upon completion, click the Next button.
- 6) The installation process loads all of the required software. If the install program asks the user to restart the computer, the user will need to do so before running the PCCU32 software.
- 7) If there is no message that asks for a restart of the computer, the installation is complete. Click the Finish button.

3.3 Establishing Local Communication

As discussed previously, local communication may be established in different ways: RS-232 MMI cable, USB cable or Bluetooth. The user's unit may be configured for one or the other or both. TCP/IP is available but is designed for use over a network setup.

3.3.1 Connecting to Local Port Via a RS-232 Cable

If the unit is configured to include the local RS-232 communication port, the connection is made using the RS-232 cable. This connects the laptop computer to the local port on the meter.

3.3.1.1 Step-by-Step Instructions

- 1) Connect the MMI cable to the designated port on the PC (default is COMM 0) and to the local port located on the μ FLO^{G4}.
- 2) Open PCCU32.
- 3) With the MMI cable connected, click the Connect icon on the PCCU32 main toolbar. The Local Connect screen will display.



TIP

If the Invalid Security Code screen displays, enter four zeros (0000) for the new code. Upon completion, click the OK button. The μ FLO^{G4} should have defaulted to 0000 on start up.

If the meter has been given a security code, the user needs to ensure they have entered that code in PCCU32's System Setup screen (see Figure 3-1). However, if the meter has been cold started, the security code will be reset to the factory default and historical data will be lost.

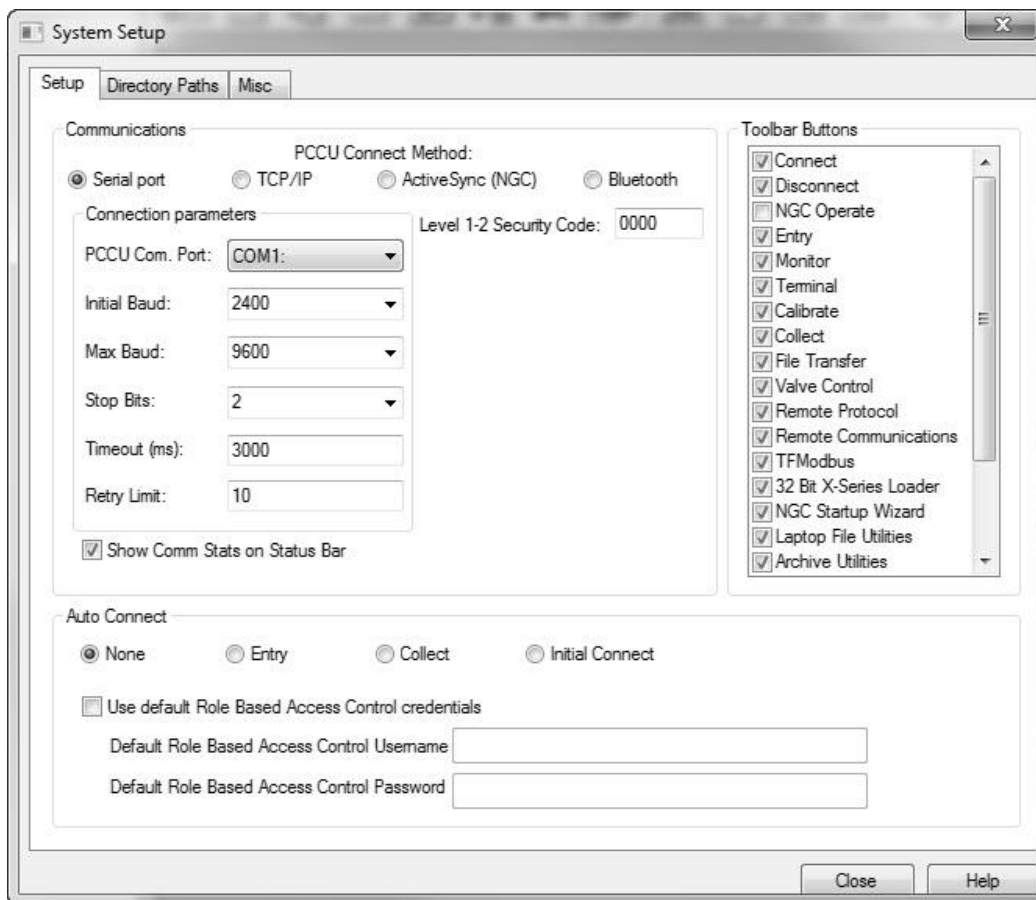

Figure 3-1 System Setup Screen

- 4) The Local Connect screen displays five buttons: Collect Historical Data, Entry Setup, Monitor, Calibrate and Registry (see Figure 3-2). Click the Entry Setup button to move to the Station Setup screen. Links within the PCCU32 tree-view will enable the user to move to screens for setup and daily operation.

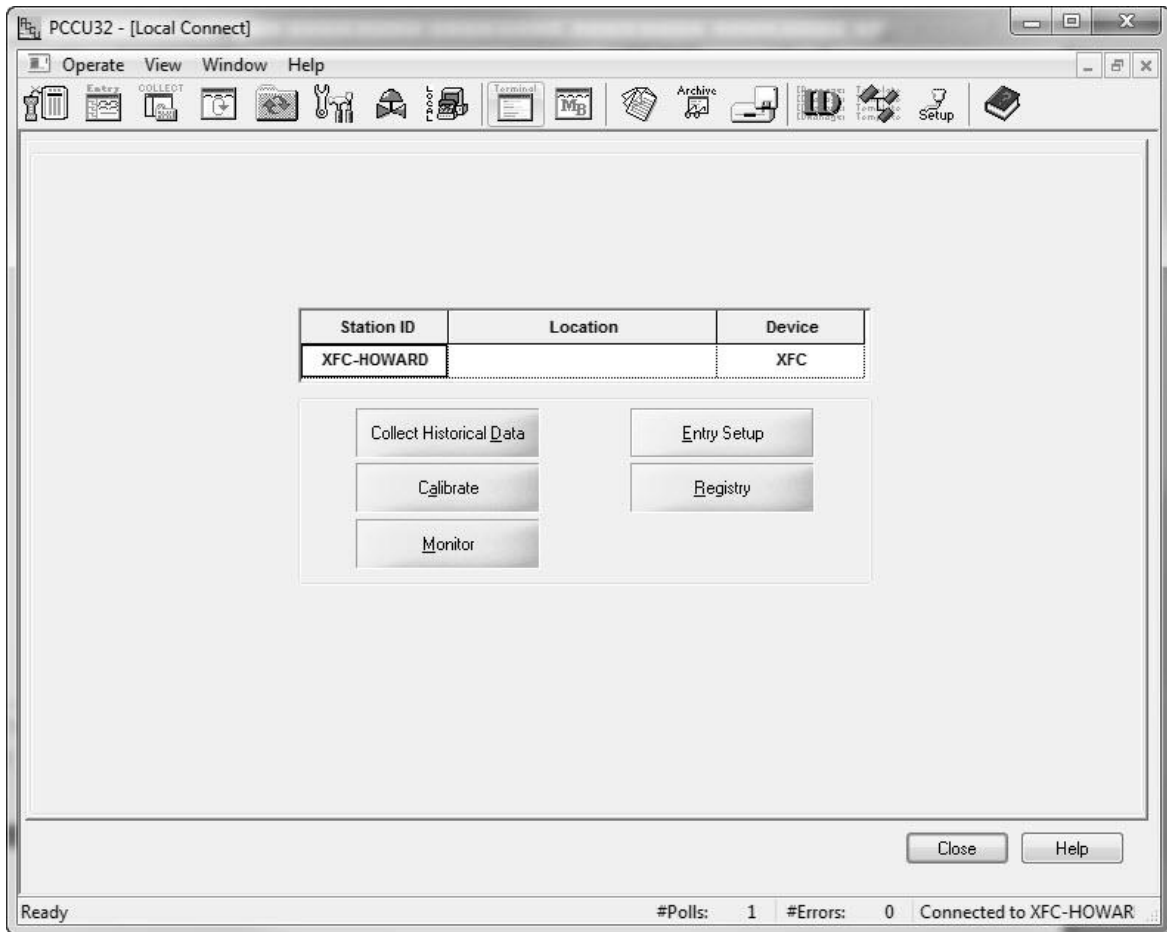

Figure 3-2 Local Connect Screen

3.3.2 Connecting to the Local USB Port

If the μ FLO^{G4} is configured to include the local USB communication port, the connection is made using the USB cable. This connects the laptop computer to the local port on the meter. This port is located on the side of the standard μ FLO^{G4} enclosure.

Before the user is able to communicate with the μ FLO^{G4} using a USB cable, they will first need to install the ABB Totalflow USB driver.

3.3.2.1 Step-by-Step Instructions

- 1) If the μ FLO^{G4} and the user's laptop are powered up when the connection is made, the Found New Hardware Wizard screen displays.
- 2) When the wizard launches, the user is asked if Windows can connect to Windows Update to search for software. Select the No, not this time option.
- 3) Upon completion, click the Next button.



Figure 3-3 Windows Found New Hardware Wizard

- 4) The user will now need to install the Totalflow.inf file. When the next screen in the wizard displays, select the Install from a list or specific location option (i.e., the PCCU32 folder). When finished, click the Next button.



Figure 3-4 Specific Location Selection

- 5) In the next screen to display, select the Include this location in the search option. Browse to the PCCU32 folder. In Figure 3-5, the folder PCCU7 was named as such to draw attention to the fact that the user will need to run PCCU32 version 7.22 or later with the μ FLO^{G4}. After browsing to the folder that contains Totalflow.inf, click the Next button.

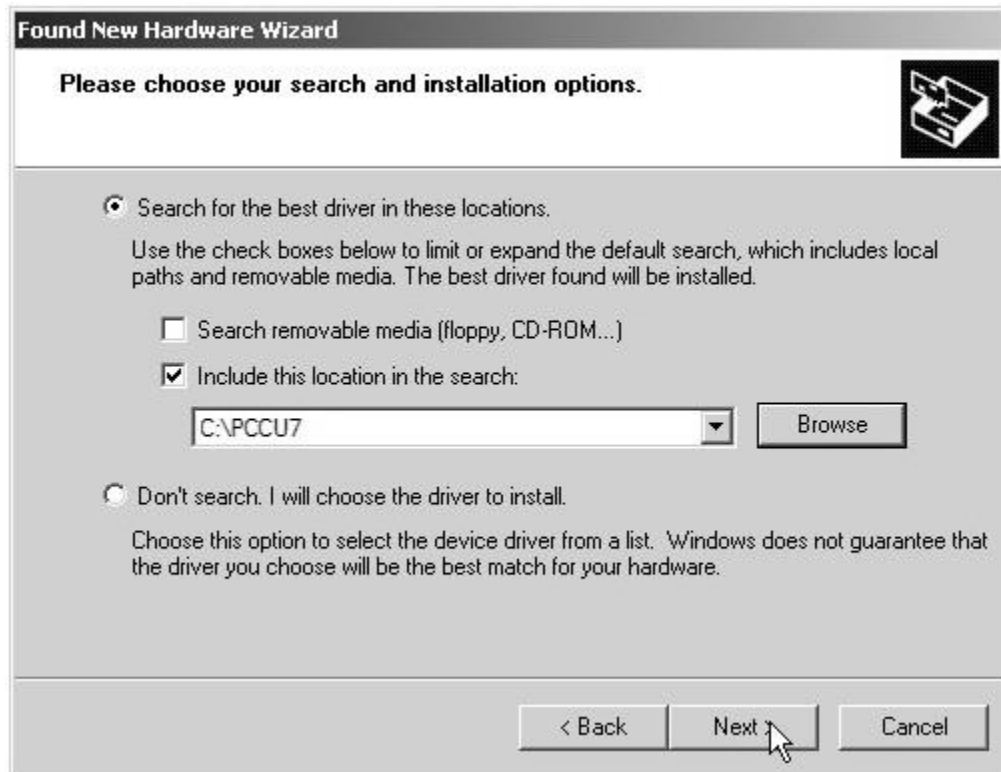

Figure 3-5 Specify Location for USB Driver (Totalflow.inf)

- 6) At this point, the user may receive a Microsoft message warning that ABB Totalflow USB driver has not passed Windows Logo testing. If the user elects to use the laptop's USB port, they will need to click the Continue Anyway button and proceed with the installation.
- 7) The installation procedure begins loading the Totalflow.inf. This takes only a few seconds.
- 8) Click the Finish button. This will complete the installation process.
- 9) The user will now need to click the Windows Start button. From the pop-up menu, select Control Panel.
- 10) When the Control Panel window displays, select Device Manager.
- 11) In the Device Manager window, the user will need to select Ports. Expand the Ports menu. The user will now see all of the port assignments. \
- 12) The user will need to verify the com port that has been assigned to the Totalflow 32-Bit XSeries. Open PCCU32.
- 13) Without connecting to the device, click on Operate in the main toolbar. From the drop-down menu, select Setup.
- 14) From the Setup fly-out menu, select System Setup. When System Setup dialog box displays, select the Serial Port radio button.

- 15) Next, click on the PCCU Com Port parameter drop-down menu. From the available options, select the comm port number that was assigned in step 12. Upon completion, click Close.
- 16) With the USB cable still connected, the user can now click on the Connect icon on the PCCU32 main toolbar. The Local Connect screen will display.
- 17) In the Local Connect screen, click the Entry Setup button. This will take the user to the Station Setup screen. Links in the PCCU32 tree-view will move the user to various screens for set up and daily operations.

3.3.3 Setup of the μ FLO^{G4} for Ethernet Connectivity

To set up the meter for an Ethernet connection, the user must first connect locally using either the RS-232 or USB cable. Using the local connection allows the user to set up the meter for Ethernet connectivity.

Currently, there are a variety of methods for completing this task. The following procedures will cover two such methods.

3.3.3.1 Method 1

- 1) Connect locally using either the RS-232 instructions or the USB instructions covered in the previous section(s).
- 2) In PCCU32 Entry mode, select Communications from the tree-view. Upon selection, click on the **Network** tab.
- 3) The user will need to enter a Network ID, and set the Enable DHCP parameter field value to Yes. The other fields within the tab will auto-populate (see Figure 3-6).
- 4) The user will now need to locate the Totalflow-TCP selection under Communications in the PCCU32 tree-view (see Figure 3-7). Once selected, the user is taken to the Setup tab. In this tab, the user needs to set the Protocol parameter value to Totalflow/TCP. When done, click the Send button.

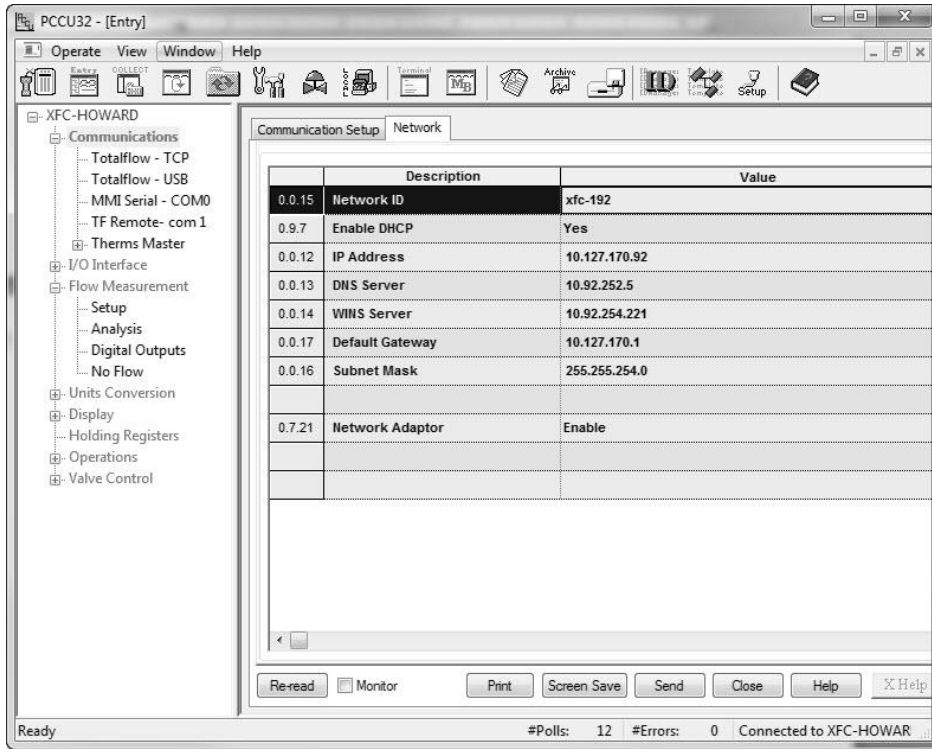

Figure 3-6 PCCU32 Network Tab

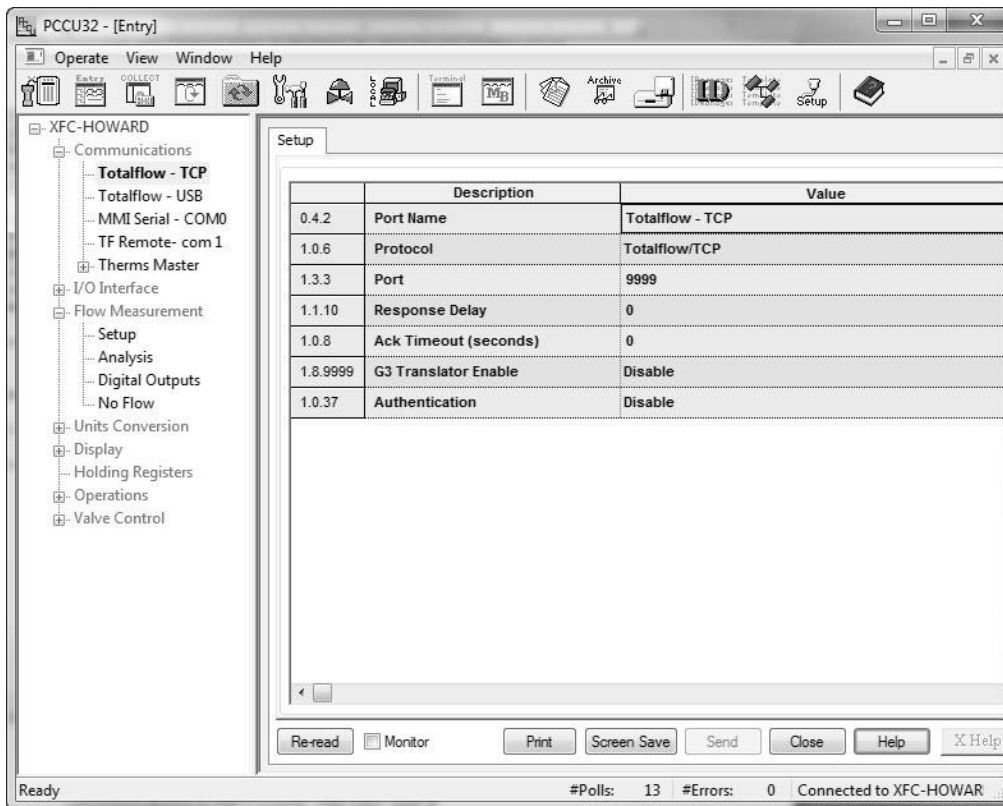

Figure 3-7 Totalflow-TCP Setup Tab

- 5) While still in PCCU32, the user needs to click the Setup icon from the PCCU32 main toolbar.
- 6) In the System Setup dialog box, click the TCP/IP radio button (see Figure 3-8). The user will then enter in the network ID or IP address for the meter in the corresponding parameter field. The network ID is the same ID that the user entered earlier within the meter set up.
- 7) When this has been completed, click the Close button.

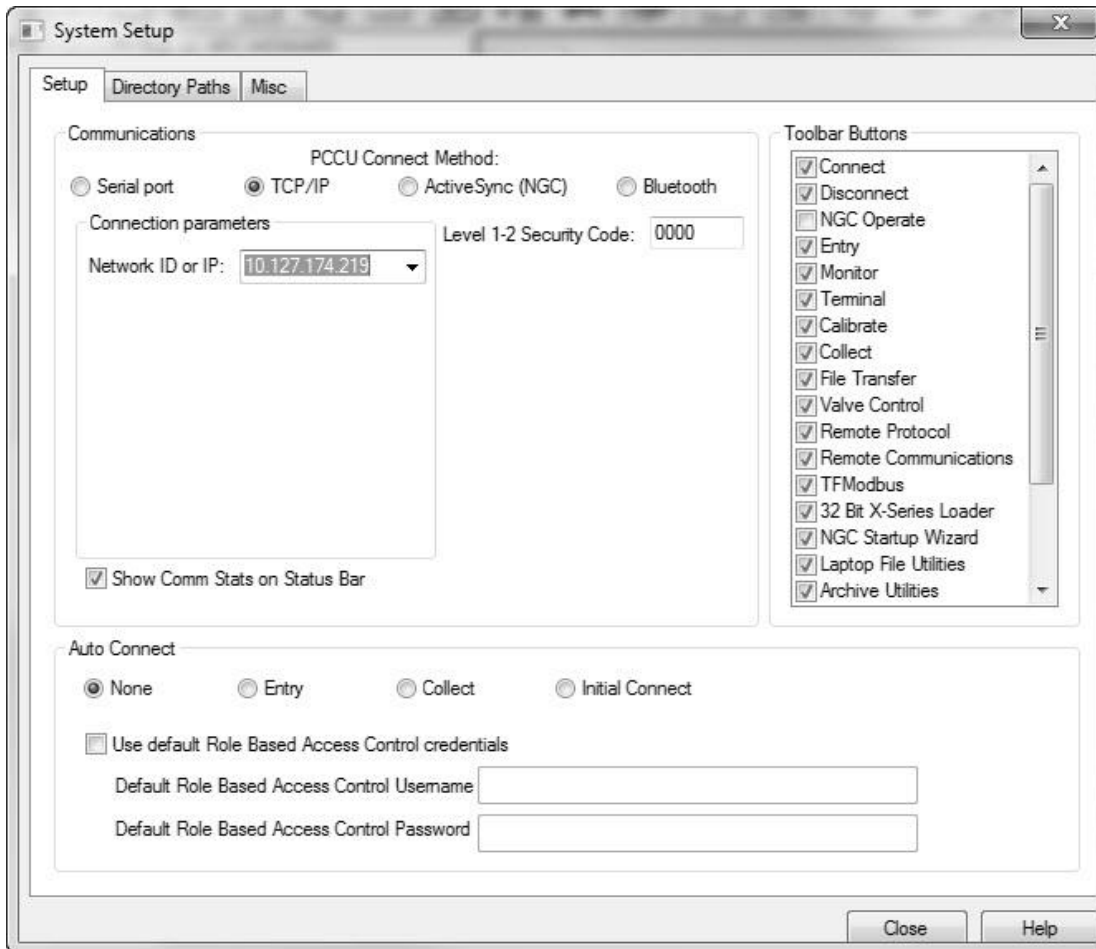

Figure 3-8 System Setup Dialog Box

- 8) Exit PCCU32 and the local connection.
- 9) With the Ethernet cabling installed, connecting to the meter is no different than when using the PCCU cable or military connector. Click on the Connect to Totalflow icon in the PCCU32 main toolbar. To connect and move directly into Entry mode, click on Entry instead of the Connect icon.



TIP

If the user has several meters on their network, they might find it helpful to create a desktop shortcut for each meter. For instructions to accomplish this task, follow steps 10-12; otherwise, continue on to the next section.

- 10) Create a desktop shortcut, and assign a name to it. For the sake of the example, the following will use the meter ID for the shortcut.

- 11) The user will now need to point to the version of PCCU32 that they want to use (the user may have multiple versions of PCCU32 on their laptop). It should be noted that it must be PCCU32 version 7.22 or later.
- 12) The user will now need to identify the network protocol to be used (TCP) and the network ID (see Figure 3-9).

For example:

- Point to the folder with OPCCU32 in it.
- Point to PCCU32.exe.
- Point to the protocol (TCP).
- Point to the specific network address (XFC-192)
- String the enter address together: C:\PCCU7\pccu32.exe TCP:XFC-192.

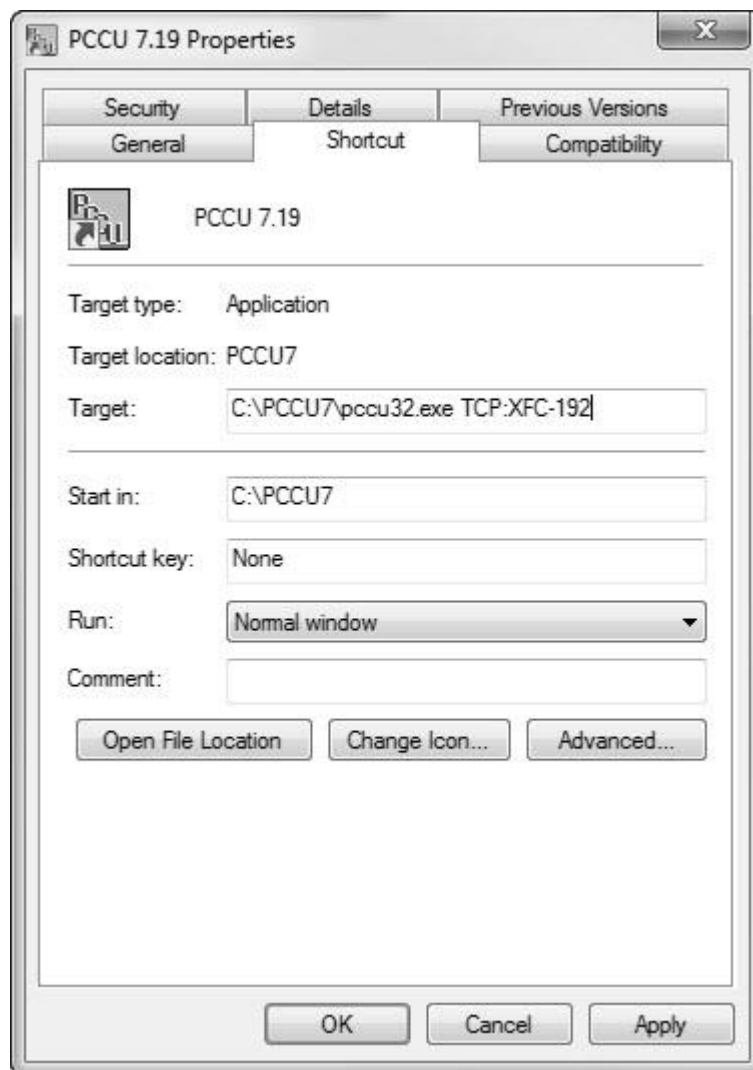

Figure 3-9 Windows Desktop Shortcut Dialog Box

3.3.3.2 Method 2

- 1) Connect locally using either the RS-232 instructions or the USB instructions covered in the previous section(s).
- 2) In PCCU32 Entry mode, select Communications from the tree-view (see Figure 3-10). Upon selection, click on the Network tab.
- 3) In the Network tab, set the Enable DHCP parameter field value to No. Click the Send button. The remaining field within the Network tab will auto-populate.
- 4) While the user is still in the Network tab, move to the IP Address parameter field. Type in the IP address that is reserved for the device. Click the Send button.

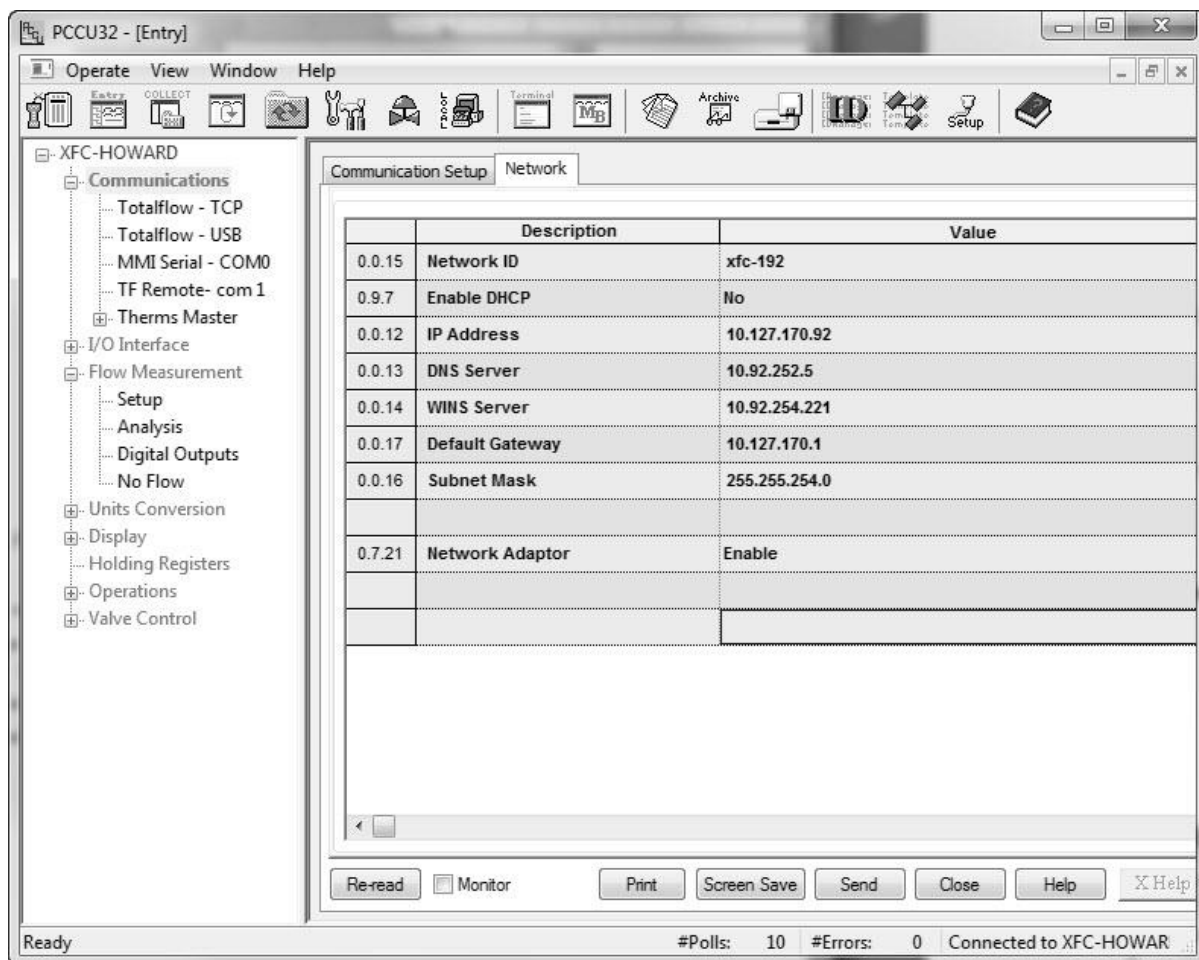

Figure 3-10 Network Tab

- 5) Close PCCU32.
- 6) Open the door to the unit, and locate the Reset button on the board (S2). Upon location, press the Reset button. This will set the IP address on the board.
- 7) The user will now need to reopen PCCU32, but do not connect.

- 8) From the PCCU32 main toolbar, click the Setup icon. This will take the user to the System Setup dialog box (see Figure 3-11).
- 9) Within the System Setup dialog box, the user needs to select the TCP/IP radio button.
- 10) Move to the Network ID or IP parameter field. Type in the IP address that was established in step 4.

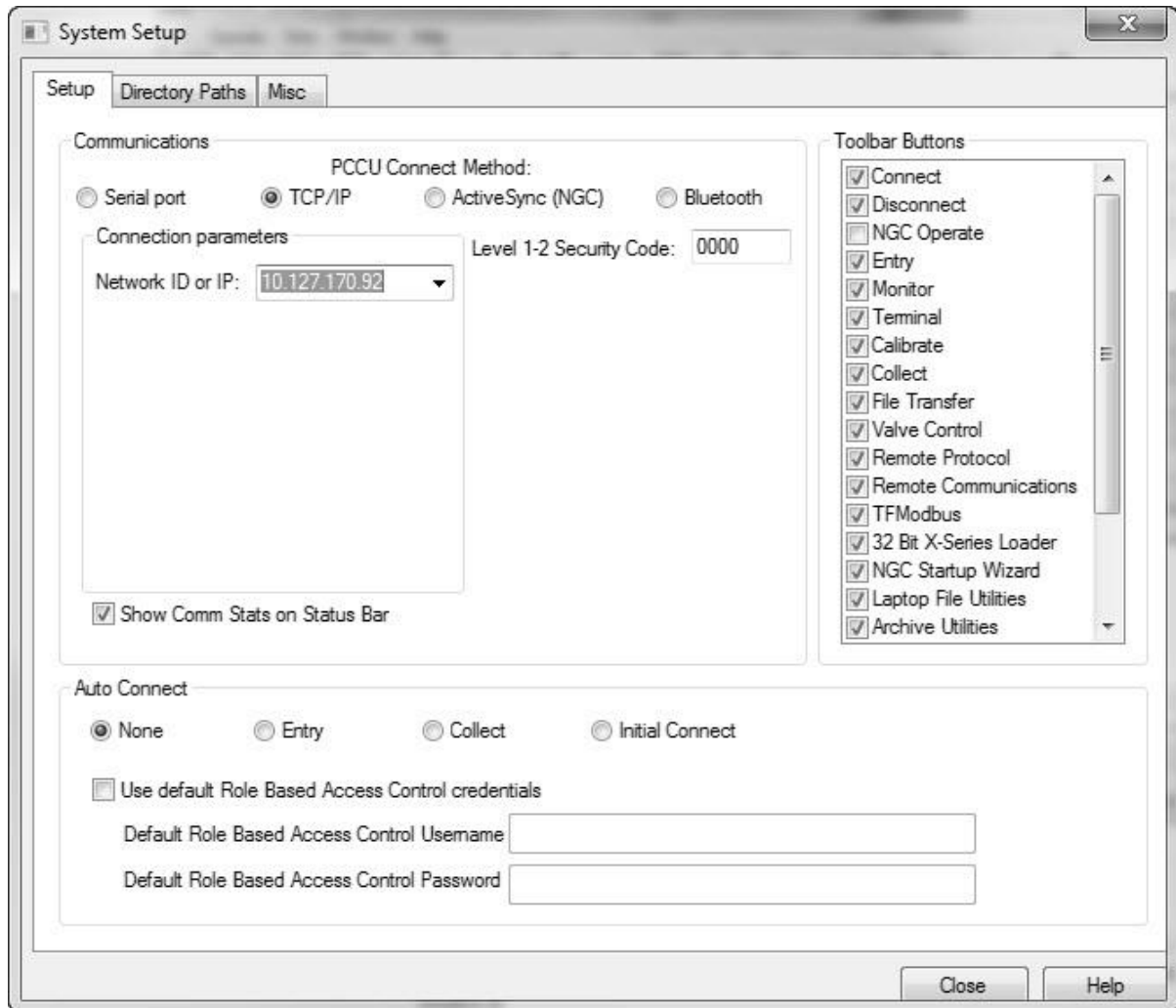

Figure 3-11 System Setup Dialog Box

- 11) Click the Close button
- 12) Reconnect to PCCU32, and move back into Entry mode. This establishes the Ethernet connection

3.3.4 Setup of the μ FLO^{G4} for Bluetooth Connectivity

The following instructions detail the steps necessary for setting up the μ FLO^{G4} for Bluetooth connectivity.

FYI



It is important that the user's computer have Bluetooth capability. Additionally, the Bluetooth option must be turned on within the computer before attempting these steps. If the user does not have a computer with Bluetooth capability (older models), an additional Bluetooth dongle will need to be purchased and plugged into the corresponding USB port on the computer.

3.3.4.1 Step-by-Step Instructions

- 1) The user needs to first plug the provided USB cable (P/N 1803180-001) into the μ FLO^{G4} motherboard (J4).
- 2) Once the cable is plugged in, the user needs to then plug the Bluetooth dongle into other end of the USB cable.

FYI



The user needs to ensure that the Bluetooth dongle is USB 1.1 compatible. Currently, most Bluetooth dongles are USB 2.0 but are backwards compatible to USB 1.1. If this is not the case, the user needs to locate a Bluetooth dongle that is either USB 1.1 compatible or backwards compatible.

- 3) Open and connect to PCCU32.
- 4) In the PCCU32 tree-view, click on the Communications menu. This takes the user to the Communication Setup tab.
- 5) Within the Communications Setup tab, locate the Bluetooth option within the Port section. Upon location, click on the Bluetooth option, and then click on the Add New Device/Application button.

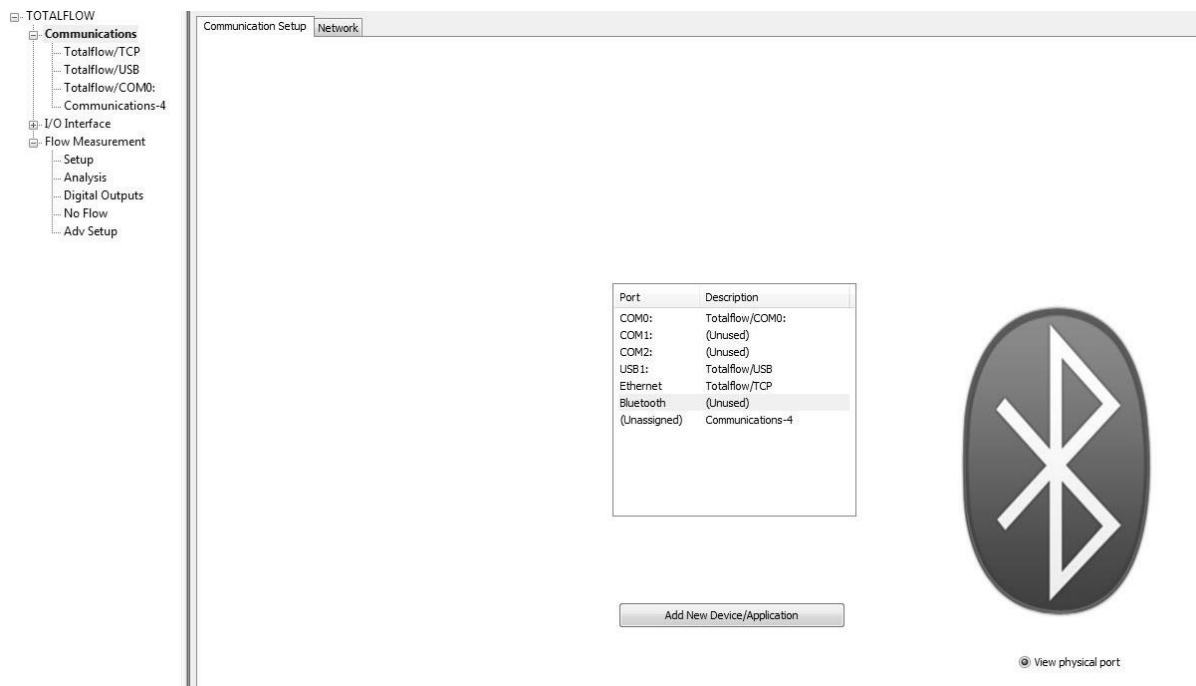

Figure 3-12 Communications Setup Tab - Bluetooth

- 6) The Add/Modify Communication Devices and Applications dialog box displays. Ensure that the Bluetooth radio button is selected. Click the OK button. This takes the user back to the Communications Setup dialog

window. The user should notice that the Bluetooth port has been assigned a description.

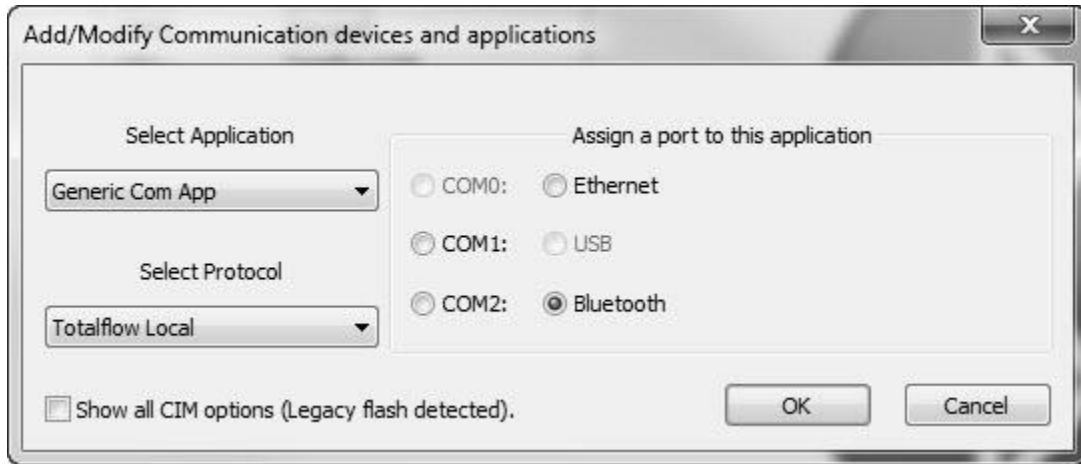

Figure 3-13 Add/Modify Communication Devices and Applications Dialog Box - Bluetooth

- 7) Within the Communication Setup tab, click the Send Changes to Device button.
- 8) After the changes are sent to the device, the user should notice that a Bluetooth sub-menu displays under the Communication option. The user can click on the sub-menu and view the settings that are established for the Bluetooth device.

FYI



The user should leave the parameter fields at their default settings.

- 9) The user now needs to click on the Setup icon on the PCCU32 standard toolbar. The System Setup dialog box displays.
- 10) Within the System Setup dialog box, the user needs to select the Bluetooth option in the PCCU Connect Method.

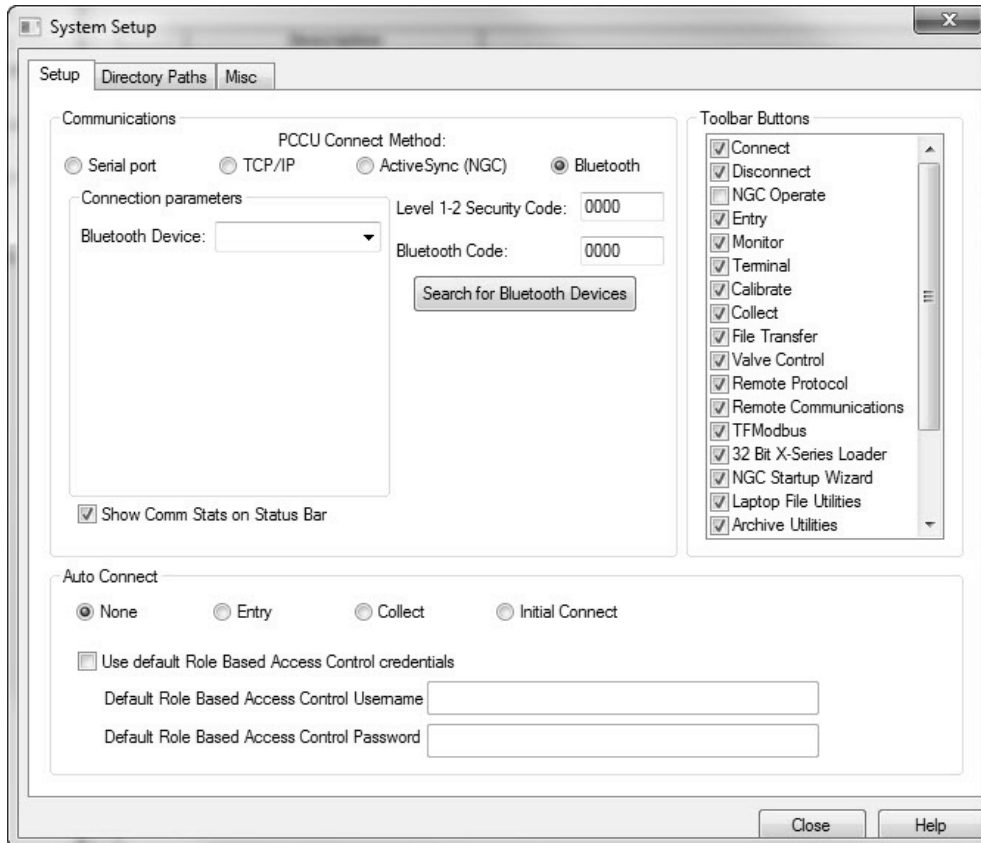

Figure 3-14 System Setup Dialog Box - Bluetooth

- 11) After the Bluetooth option is selected, several parameter fields that are related solely to Bluetooth display. Click the Search for Bluetooth Devices button.
- 12) The Select a Bluetooth Device dialog box displays. The user needs to de-select the Filter option, and then wait for the device to complete its search for available Bluetooth devices. Upon completion, click the Search Again button.

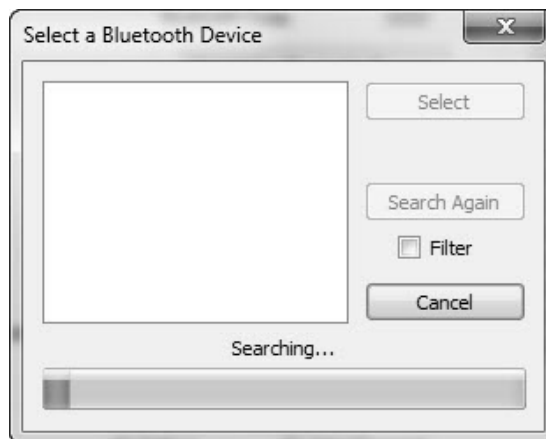

Figure 3-15 Select a Bluetooth Device Dialog Box

- 13) A possible list of Bluetooth devices display. The user can distinguish their particular Bluetooth device by the naming convention: Network ID + Mac Address. For example, if the network ID for the device is “TFLocal”, the Bluetooth device displays as “TFLocal,X:XX:XX:XX:XX:XX”.

FYI



The user can use a single Bluetooth dongle on multiple devices. When employing this method, the user does not need to worry about the name of the device, only that the Mac address is consistent across all of the devices.

- 14) Select the Bluetooth device in the dialog box. Upon choosing the correct one, click the Select button. This automatically takes the user back to the Setup tab within the System Setup dialog box. The user will notice that the Bluetooth Device parameter field is populated with the Bluetooth dongle information.
- 15) Click the Close button to finish the process.

3.4 Setting Up the μ FLO^{G4}

Once the user has physically connected to the μ FLO^{G4}, they must now instruct the programming device’s software to connect. At this time, the software will actually read the device default values that are programmed at the factory. These preset values are based on the type of product that the user has ordered and programmed for the most widely used configuration.

Depending on the programming device that is being used, the following are the minimum required entries. Specific information required to complete each step is discussed in the PCCU32 help files.

3.4.1 Station ID

The station identifier code should uniquely identify one station from that of others.

Description	Format	Note
Station ID	XXXXXXXXXX	10-digit alphanumeric

3.4.2 Device ID/Application ID

On a μ FLO^{G4}, the identifier code should uniquely identify one μ FLO^{G4} from that of others and will be the same as the Station ID.

Description	Format	Note
Device/Application ID	XXXXXXXXXX	10-digit alphanumeric

3.4.3 Location

The host software, WinCCU, has a Location field that can hold up to 24 alphanumeric characters used to describe it. An example would be the county name or road number.

Description	Format	Note
Location	xxxxxxxxxxxxxxxxxxxxxxxx	24-digit alphanumeric

FYI



There are additional fields stored in WinCCU for uniquely identifying the meter, including fields for entering the lease holder, producer, operator and buyer. These fields reside on the host computer in the ID Manager and not the μ FLO^{G4}.

3.4.4 Date/Time

The μ FLO^{G4} date and time should be set before other tube parameters are entered. This ensures that events are properly dated and time tagged. The μ FLO^{G4} date and time must be set correctly and should agree with the collection equipment. PCCU32 or WinCCU can be used to update the date and time of the device.

Description	Format	Note
Date	MM/DD/YY	Must enter two (2) digits each
Time	HH:MM:SS	24-hour clock

3.5 Security Systems

Currently, there are three (3) types of security that are possible:

- Device-enforced legacy level 1-2 security
- WinCCU-enforced legacy security
- Device and PCCU32-enforced Role Based Access (RBAC) security

The following sections will cover these security options.

3.5.1 Device Security

Data and configuration security in the μ FLO^{G4} is spread across three elements: the flow meter, PCCU32 and WinCCU.

The μ FLO^{G4} has a security switch (S1) on the μ FLO^{G4} board. Password security is bi-level: read only (security code level 1) or read/write (security code level 2).

3.5.1.1 Meter Security

To establish meter security, the user must have the security switch in the OFF position. When this has been completed, locally connect with PCCU32.

- 1) Enter a four-digit number for level 1 and level 2 security (see Figure 3-16). Upon completion, click the Send button.

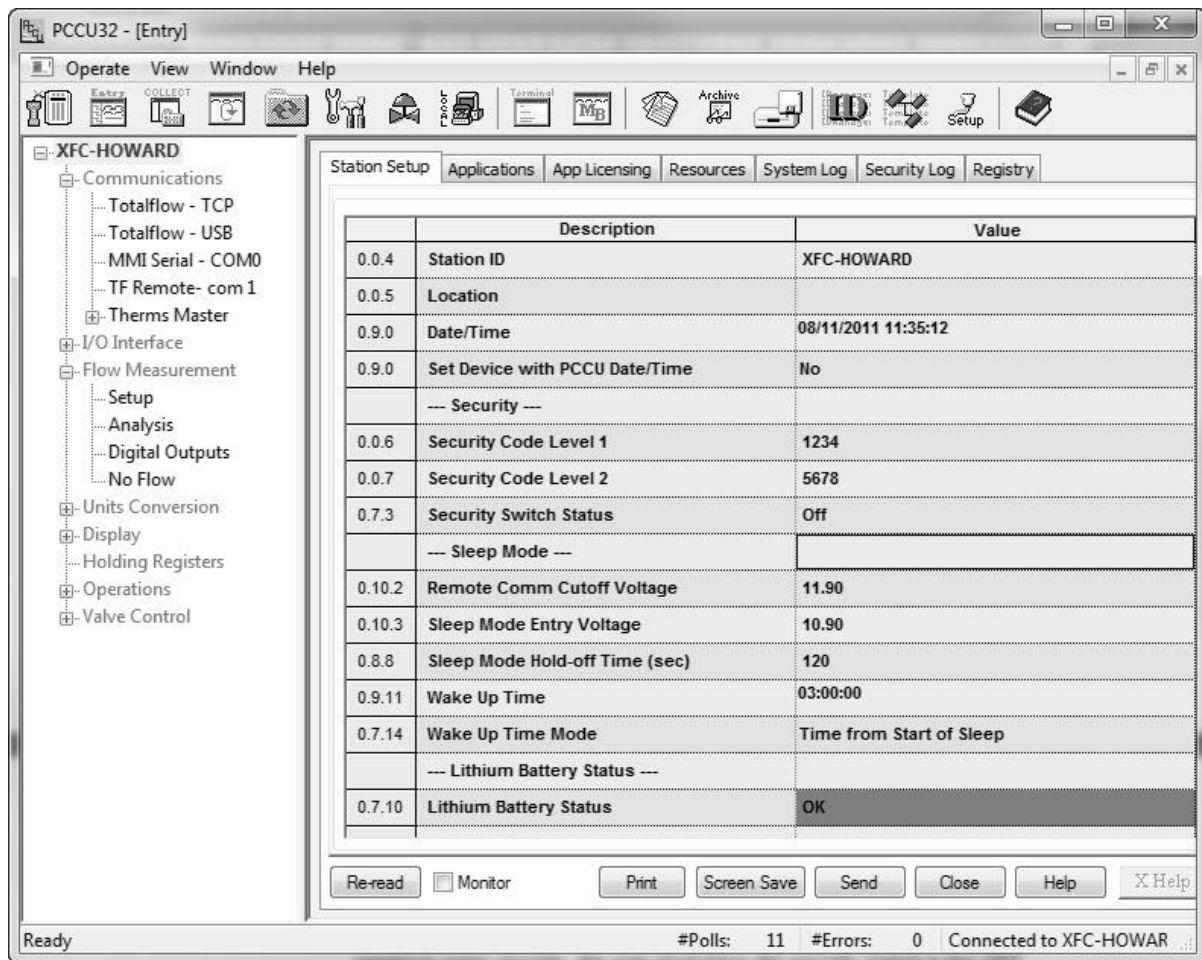

Figure 3-16 Station Setup Tab

Turning the security switch (S1) ON will activate the security codes. The level 1 code will allow data and configuration values to be read but not altered. The level 2 code will allow full access to read and write.

These security codes must be entered into PCCU32 and WinCCU32 to provide the appropriate access to the meters. However, WinCCU32 will always need the proper security code regardless of the position of the security switch (S1). Turning the security switch OFF does not allow unprotected access for a WinCCU32 operator.

FYI



Modbus access to the meters is not protected by the security codes.

3.5.1.2 PCCU32 Security

PCCU32 requires the appropriate security code to be entered. To enter the security code, the user needs to move to System Setup in PCCU32. In the provided example (see Figure 3-17), the user has been provided with read-only access to the meter.

The security code level of 1234 (per Figure 3-17) provides read-only access to the meter. If 5678 was entered, the user would have full read/write access to the meter.

FYI



If the security level is breached, the user will receive a message indicating that they do not have privileges to perform that particular action.

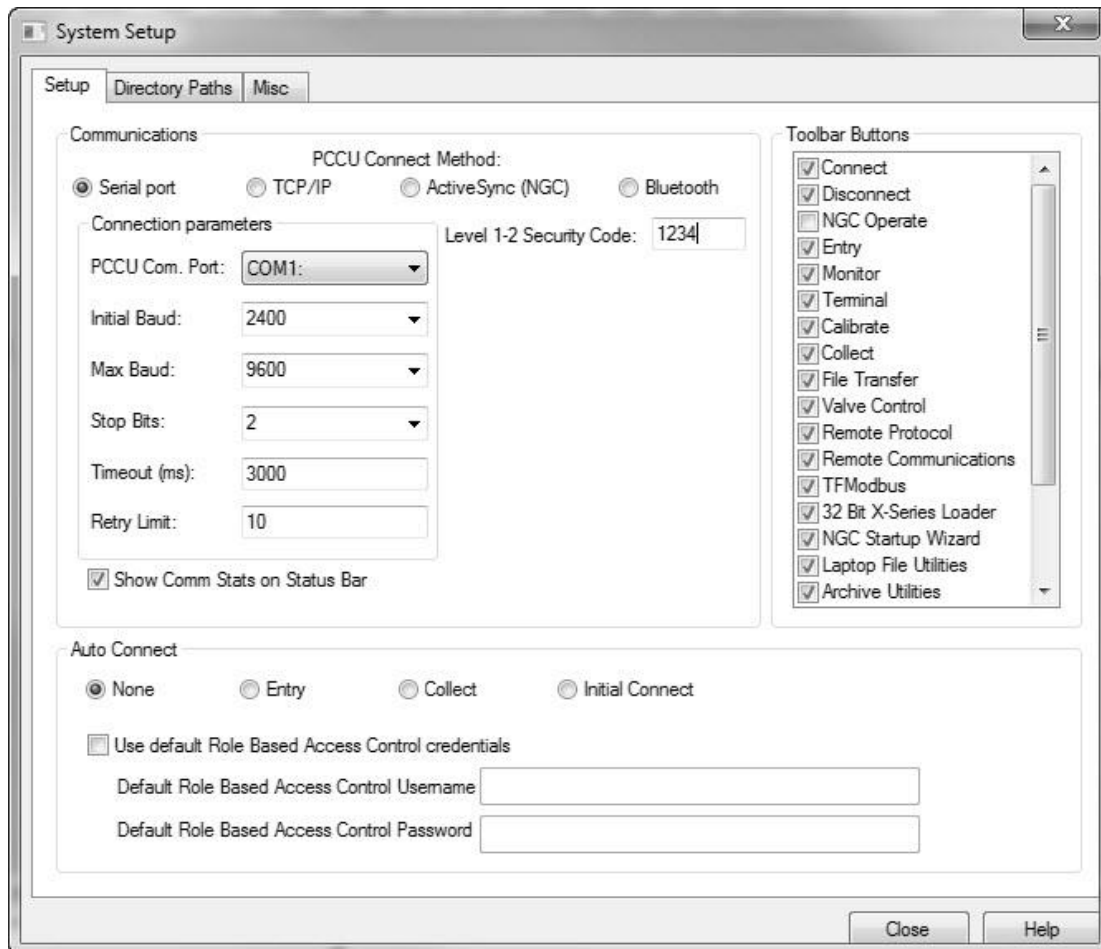

Figure 3-17 System Setup Dialog Box

3.5.2 WinCCU32 Security

WinCCU32 also requires the appropriate security codes (see Figure 3-18). Highlight the appropriate meter, and click Edit ID.

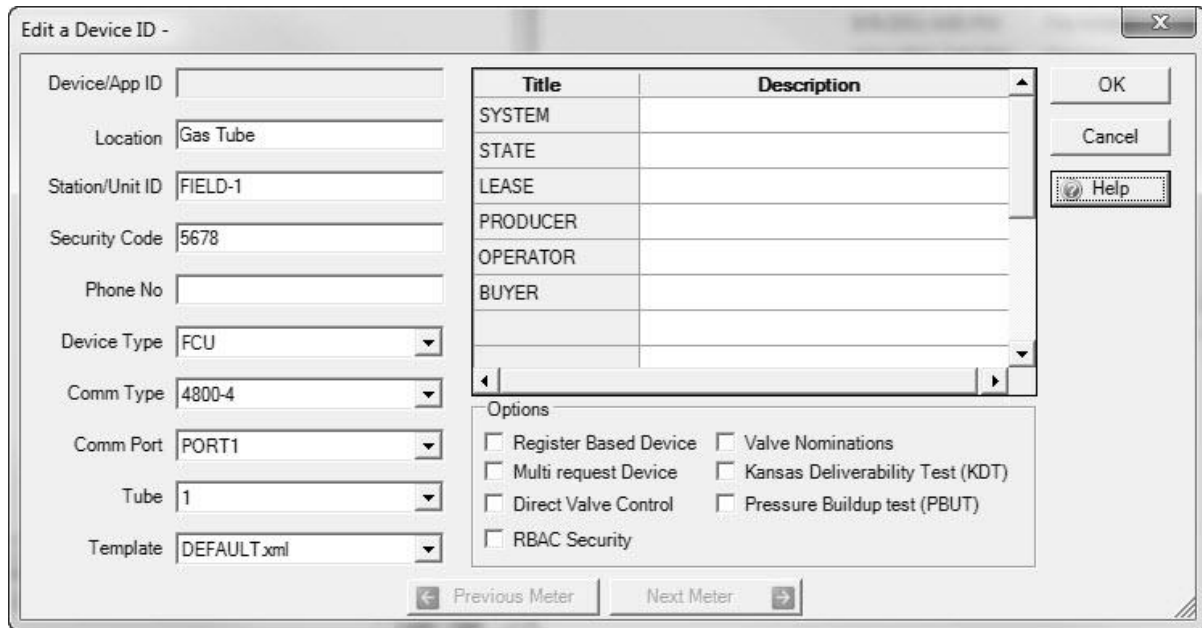



Figure 3-18 WinCCU32 Edit a Device ID Dialog Box

The security code, level 2 of 5678 (per Figure 3-18) has been entered. This gives the WinCCU32 user full read/write access to the meter.

FYI  Modbus access to the meter is not protected by the security code.

3.5.3 Role Based Access Control (RBAC)

Role Based Access Control (RBAC) is a feature within PCCU32 that is designed to allow an administrator to designate roles and control access levels to various applications and processes in the μ FLO^{G4} device.

Beginning with a set of default roles, it is possible to duplicate, rename and delete these items to create a working list of access roles that are relevant to the user's company hierarchy. From this role list, it is then possible to create user accounts with various assigned roles. The user is also given the ability to take the newly created configuration and save it in the form of a security file to their PC. The security file can then be sent to a μ FLO^{G4} device, where it is then implemented.

FYI  RBAC is enforced by both the μ FLO^{G4} and the PCCU32 interface for G4 devices. Enforcement on devices is on a port-by-port basis. When RBAC is enforced, type 1 and type 2 security is superseded.

3.5.3.1 Security File Configuration

RBAC configurations can be defined and saved in a security file. This mainly includes Role Definition, User Configuration and Port Configuration.

The following instructions provide information for creating and editing a security file:

- 1) After PCCU32 has been opened, move to the Security option under Operate within the PCCU32 main toolbar. Select Role Based Access

Control and the Role Administration from the fly-out menu (see Figure 3-19).

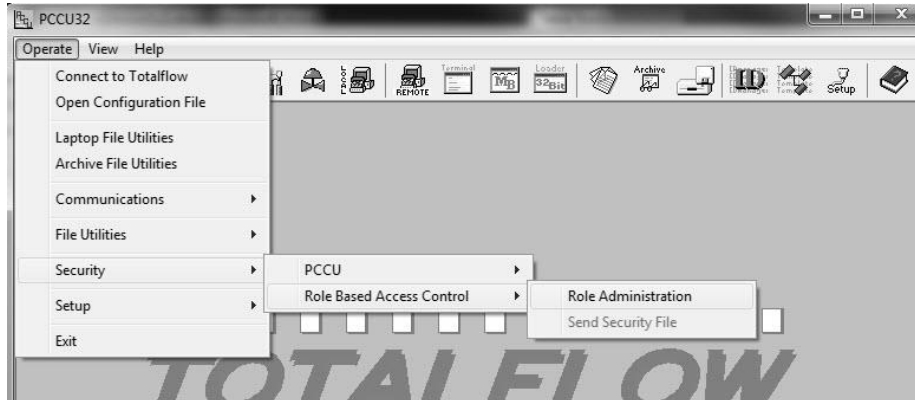

Figure 3-19 Role Administration Menu Path

- 2) Once the Role Administration has been selected, the Security Editor dialog box displays (see Figure 3-20).

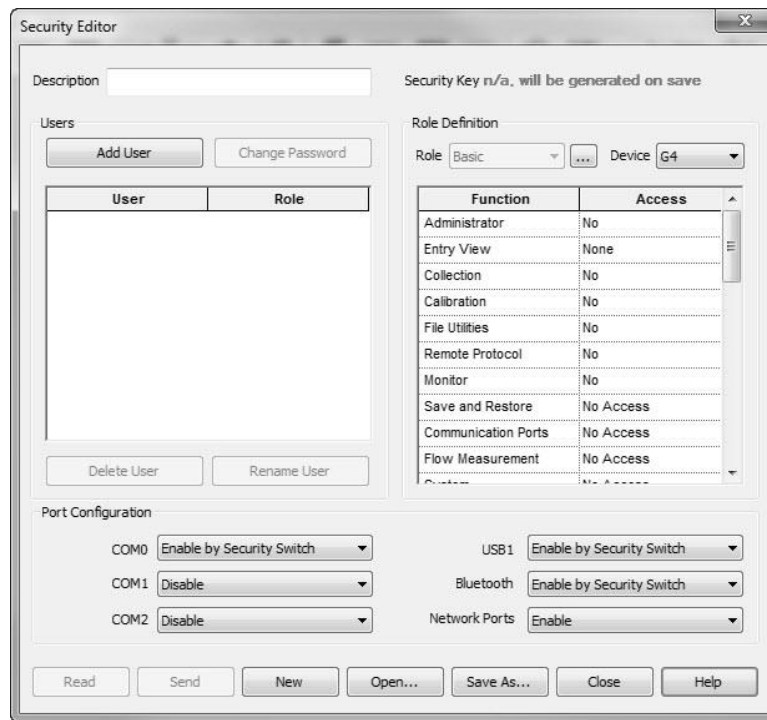

Figure 3-20 Security Editor Dialog Box

RBAC security files are supported by G4 and NGC devices. The user is given the ability to select the device type that the security file is specifically intended for.

For each role, it is possible to set the access level for each function that is listed. The Entry View function sets the highest selectable level and has the options of None, Basic, Advanced or Expert. Other functions have either a Yes | No option or a No Access | Read Only | Read/Write option. If an existing role definition does not provide the proper capabilities, a new one can be created by clicking the Browse

button next to the Role drop-down list. This brings up the Roles dialog box (see Figure 3-21).

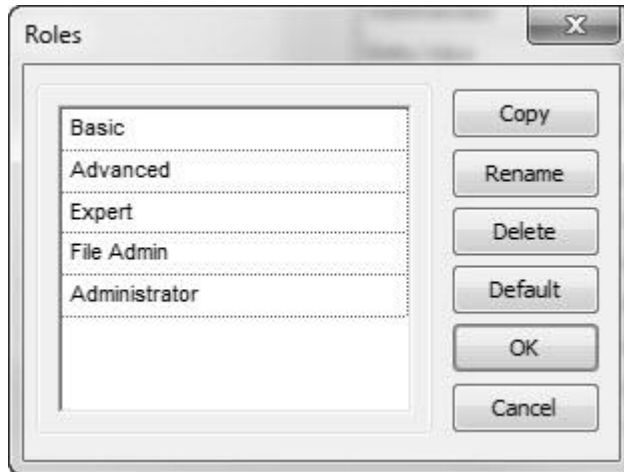

Figure 3-21 Roles Dialog Box

3.5.3.2 Role Definition

Default roles are automatically installed with PCCU32. These default roles are as follows:

- Administrator
- Expert
- Advanced
- Basic
- File Admin

The Administrator role has the highest level access rights to all functions. Expert, Advanced and Basic roles have decreasing levels of access rights.

The File Admin role has the access rights of the Basic role plus minimum rights required for sending/reading RBAC security files to and from G4 devices.

3.5.3.3 Role Creation

The following instructions will walk the user through the steps for creating a new role:

- 1) Select the row that has the corresponding access level that the user prefers. Upon location, click the Copy button.
- 2) A dialog box displays and asks for the name of the new role. Assign a name to the role. The new role is then available in the Roles dialog box.
- 3) Change the access levels to complete the modification of the created role:
 - To change the name of an existing role, select the cell, and click the Rename button.
 - To delete an existing role, click the Delete button.
 - The Default button resets the Role list to the factory defaults.

3.5.3.4 User Configuration

When adding a new user, the default role is the one that is currently displayed in the Role drop-down list at the time the Add User button is clicked. The following dialog box displays to set the user name and password (see Figure 3-22).

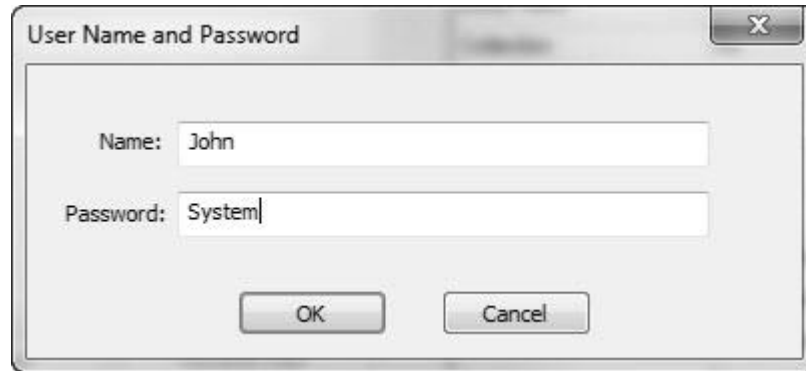

Figure 3-22 User Name and Password Dialog Box

A security key is generated and displayed after the configuration is saved to a security file. The Security Key file is displayed with “n/a will be generated on save” before a configuration is saved or after any modifications are made to a saved configuration. The security key is logged in the Security Log every time the security file is sent to a device or the device warm boots. Additionally, it can be used to verify the security file on the device is the one created by the security administrator.

The PC file name of the security file is saved in the security file and displayed in the Security Editor dialog title bar when the file is read from a device. It will also be used as a default file name, suggested for saving.

The Open button opens a security file from the PC for editing (see Figure 3-20). The New button clears all users and starts editing a new security configuration with default roles and no users.

RBAC security files are saved with a unique extension (.rba), by default. There is also a default directory that hosts these files. The directory is configurable by selecting the menu item Operate > Setup > System Setup (see Figure 3-23).

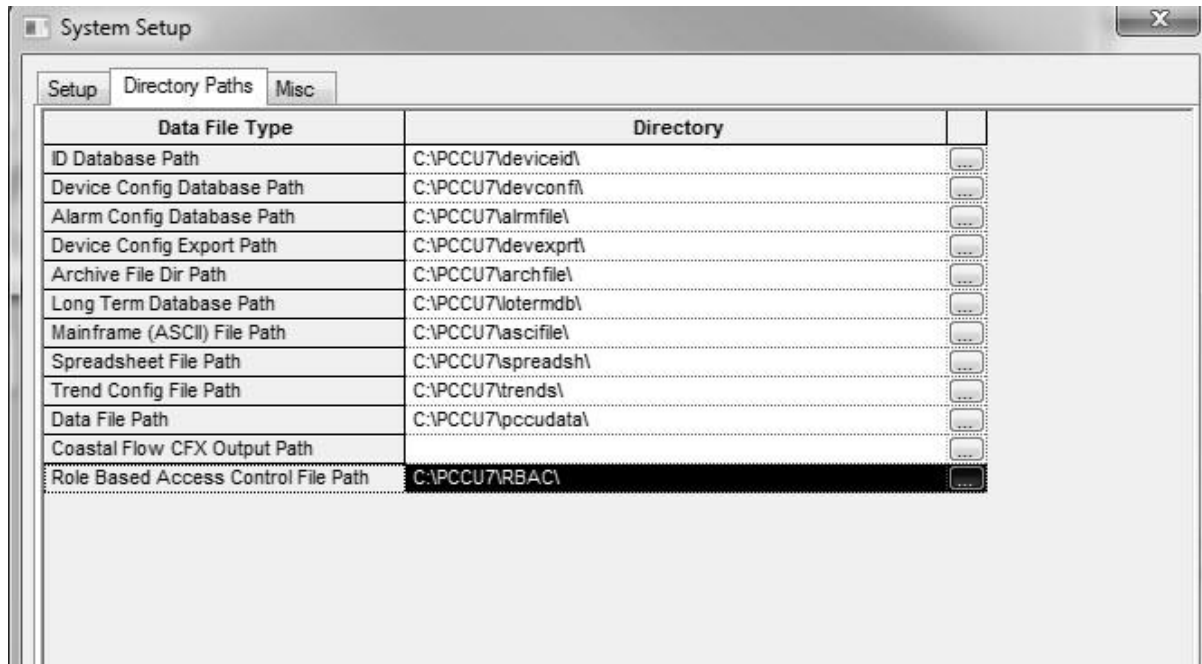

Figure 3-23 System Setup Dialog Box – Directory Paths Tab

When connected to a μ FLO^{G4}, the Read button is enabled for all users. Additionally, the Send button is enabled only for users with Administrator rights. The Read button reads a security file from the device for editing. The Send button is used to send and apply the security configuration to a device.

Another way to send a security file is to select the menu item (Operate > Security > Role Based Access Control > Send Security File). This menu item is only enabled for users with Administrator rights. Clicking the menu item displays the Send Role Based Access Control File dialog box (see Figure 3-24).

In the dialog box, the user can click the Browse button to select the required file. Upon selection, the user can click the Send button to send the security file.

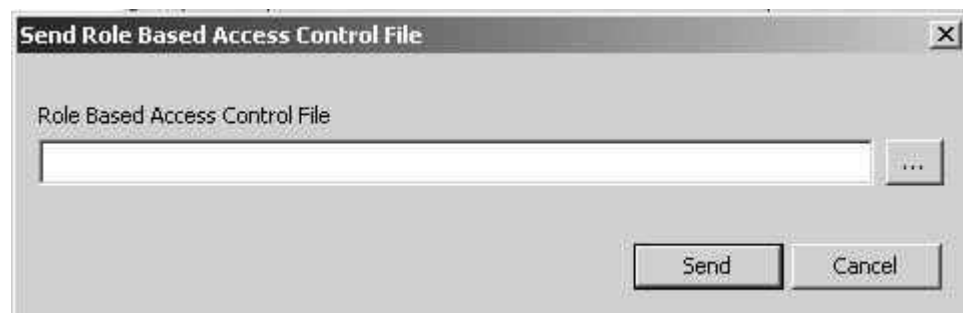

Figure 3-24 Send Role Based Access Control File

3.5.3.5 Port Configuration

Entry mode is available in the Advanced and Expert view modes and can be used to configure RBAC for ports that are not specified in the security file or can be used to override what is specified in the security file. Under each port which has a

protocol specified is a parameter field called Authentication. This parameter can be set to Disabled, Enabled or Enable by Security Switch (see Figure 3-25).

- Disabled – Does not perform any RBAC functions on the port.
- Enabled – If the administrator name and/or password are lost or forgotten, it will be necessary to use TfLoader to delete TfCold and TfData. After this has been accomplished, the user will then need to cold start the device to gain access. This will reset the device to the default factory configuration.
- Enable by Security Switch – If the administrator name and/or password are lost or forgotten, RBAC may be disabled using the legacy security switch. By setting the switch to the OFF position, a user may log in and reconfigure the security access. No data will be lost.

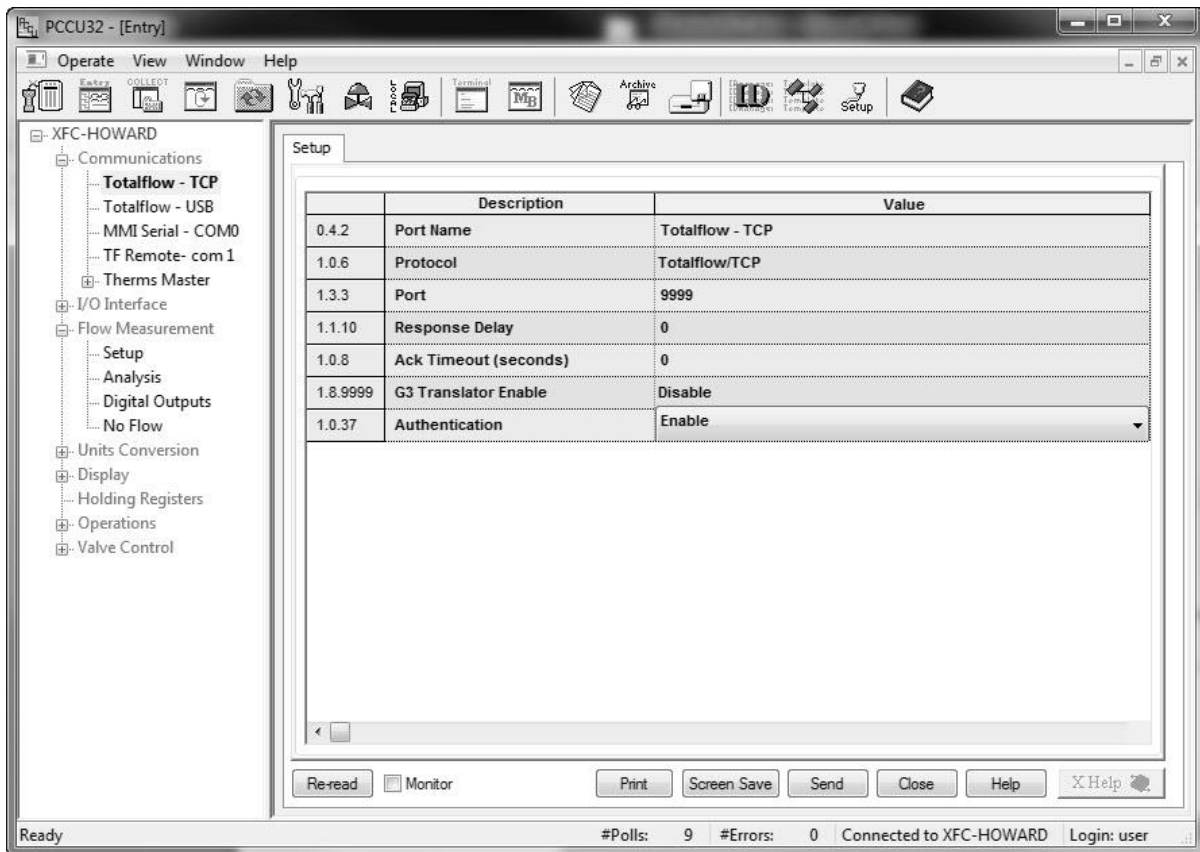

Figure 3-25 Totalflow-TCP Setup Tab

3.5.3.6 User Login

When the user tries to connect to an RBAC-enabled port on the μ FLO^{G4}, they are first asked to log in (see Figure 3-26).

The user can elect to save the user name/password as default credentials to be used for subsequent logins. To change or disable the default RBAC credentials, select the menu item, Operate > Setup > System Setup (see Figure 3-27).

After a security file is sent to the μ FLO^{G4}, the user is disconnected from the device and asked to re-login under the following circumstances:

- RBAC security was not enabled on the connected port before the security file was downloaded.

- The user is not defined in the new security file.
- The user has different access rights in the new security file.

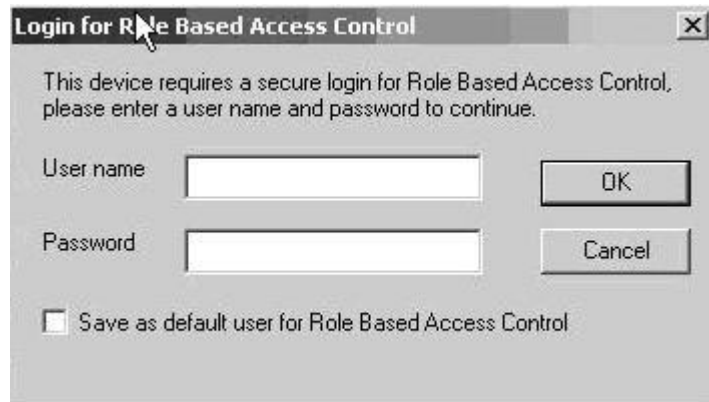

Figure 3-26 Login Dialog Box

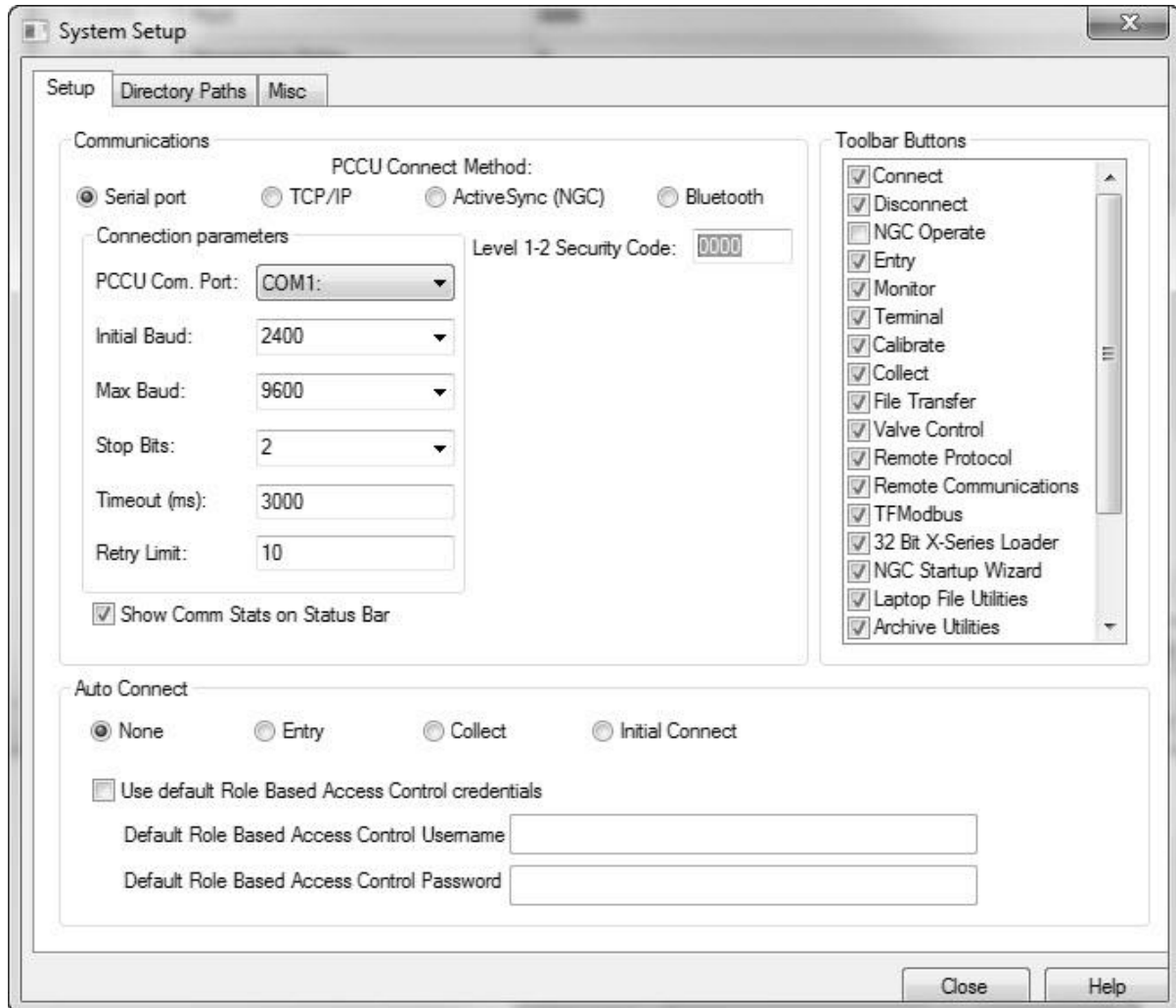

Figure 3-27 System Setup Dialog Box

3.5.3.7 Security Log

To track access to the μ FLO^{G4}, a security log is kept that indicates the date and time when a user logs in, the user name, the port where the access was made and the actions taken before logout. Log entries are also generated when a security file is downloaded and/or processed. Additionally, the results of applying the configurations will also be logged every time a new security file is downloaded. This tab is available in Advanced and Expert view modes (see Figure 3-28).

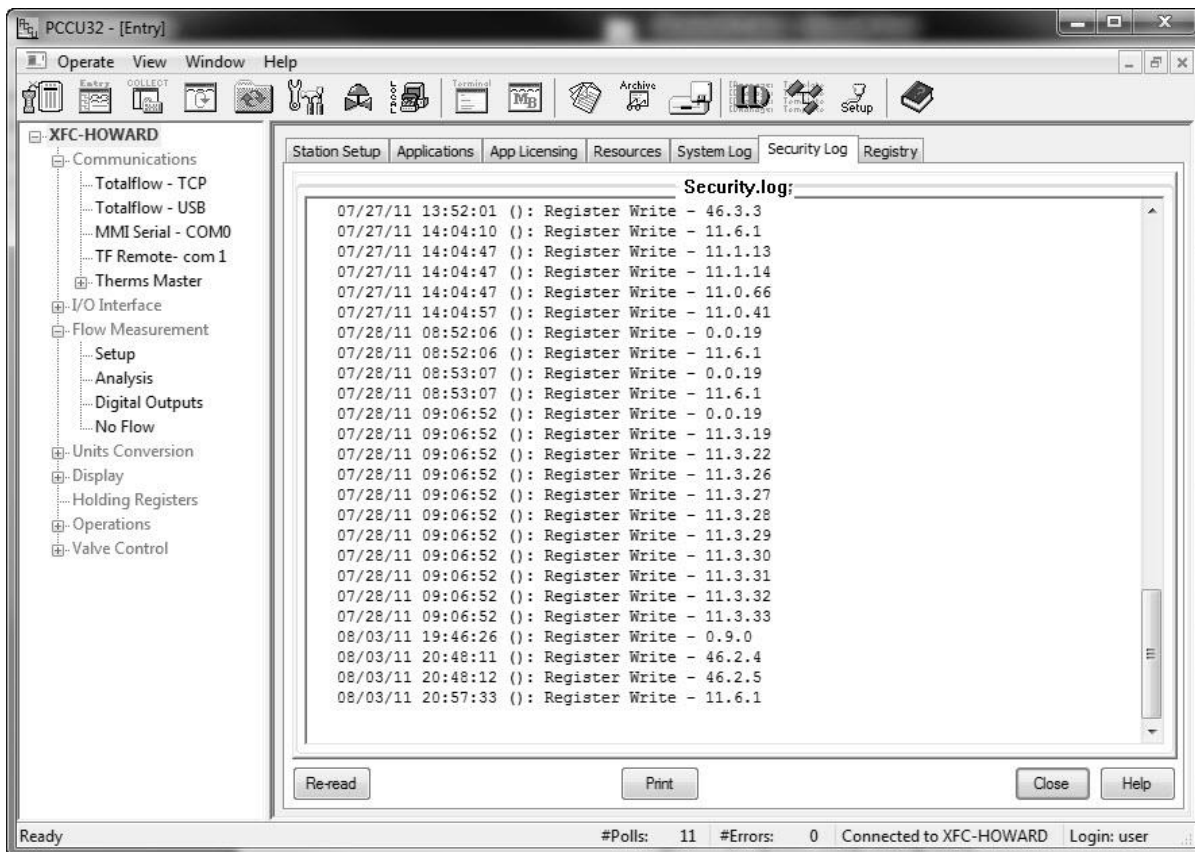

Figure 3-28 Security Log Tab

3.5.3.8 Remote Communications

While it is currently possible to enable RBAC on a remote port, this will block any access to the port since no host software currently supports RBAC.

3.5.3.9 Access Rights for Common Function

Restricted Applications

Applications that are not accessible to the currently connected user are not seen in the PCCU32 tree-view. Functions that are restricted to the user are disabled. When an application with read-only functionality is accessed, the Send button is also grayed out.

Calibration

In order for the user to perform a calibration, in addition to Calibration access rights, a user must also have read/write access to the following applications:

- System
- Flow measurement
- I/O subsystem
- Display application

For calibrating wireless I/Os, the user must have read/write access to the Wireless I/O application and the Communication Ports application.

For calibrating the IMV, the user must also have read/write access to the IMV Interface application and the Communication Ports application.

Collection

In order to perform a collection, in addition to Collection access rights, a user must also have read access to the System application.

For collecting tube data, the user must have read access to the Flow Measurement application.

For collecting trend data, the user must have read access to the Trend application.

For collecting analysis trend data, the user must have read access to the Analysis Trend application.

For collecting analyzer stream data, the user must have read access to the Analyzer Stream application and the Analyzer Operation application.

3.6 Application Licensing Credit Key

3.6.1 Credit Key Driver Installation

The following will detail the steps for installing the credit key driver.

3.6.1.1 Step-by-Step Instructions

- 1) Plug the USB credit key into an available USB port.
- 2) The Windows operating system will recognize the credit key as new hardware and attempt to install the appropriate driver with the Found New Hardware Wizard.
- 3) Click the Next button.
- 4) It may be necessary to point the wizard to the PCCU32 directory in the Files Needed screen. Select Browse, and locate the driver (usbkey.sys) in the PCCU32 directory.
- 5) Upon location, click the OK button.
- 6) The software driver installation will begin. When it is completed, click the Finish button.

FYI



If the user inserts the credit key in a different USB port on the computer, it will need to be installed for that new USB port. In other words, the credit key must be installed on each available port if the user does not intend to use the same USB port each time they use the credit key.

3.6.2 Access/View the Credit Key with PCCU32 7.0 (or later)

To access and view the credit key, the user must use PCCU32 7.0 (or later). The credit key is a secure device and only accessible through PCCU32.

3.6.2.1 Step-by-Step Instructions

- 1) Install the credit key in an available USB port.
- 2) Open PCCU32. Do not connect to the unit.
- 3) Go to the Credit Key License Utility (Operate > File Utilities > Credit Key License Utility).

FYI



To move to the Credit Key License Utility, the user cannot be connected to the μ FLO^{G4}. The user must have PCCU32 running and the initial ABB Totalflow PCCU32 screen displayed.

- 4) When the Credit Key Status and Update Utility screen displays, click Load to view the available credits on the USB key (see Figure 3-29).

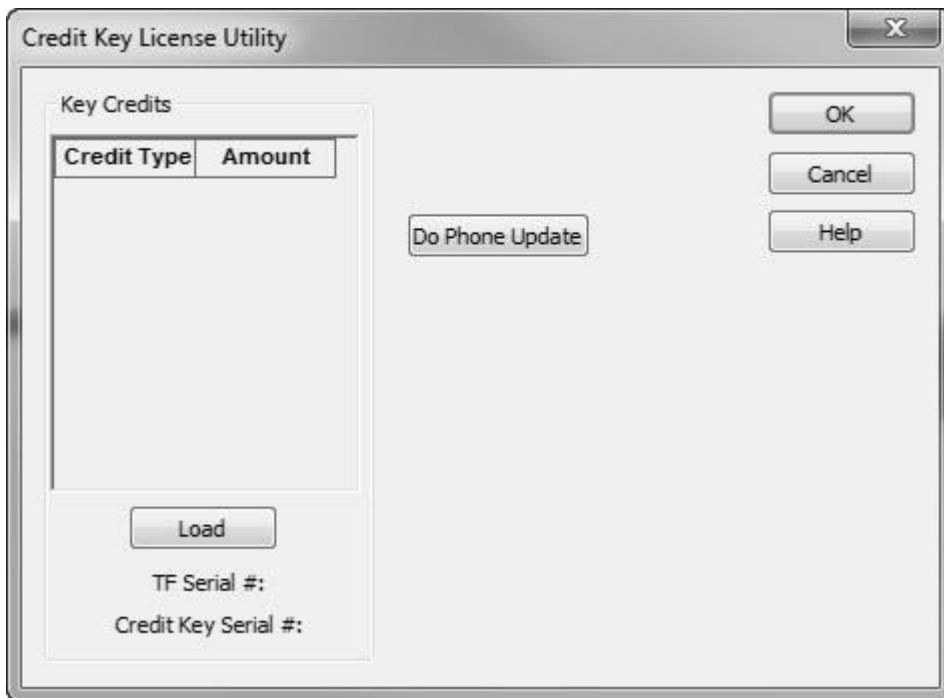

Figure 3-29 Credit Key License Utility

- 5) The number of credits will display.

TIP



This is the same dialog box that the user would use to add more credits to the credit key (see Figure 3-30).

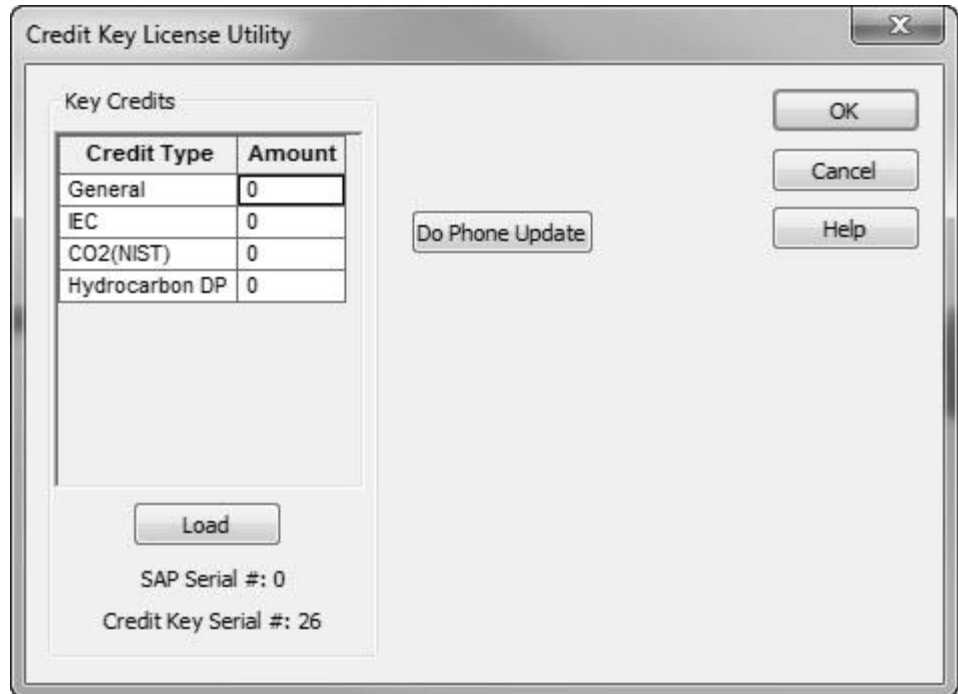

Figure 3-30 Credit Key License Utility - Status

3.6.3 Adding Credits to the Credit Key by Telephone

The user may have ordered the credit key from ABB Totalflow with a specified number of the various credits; however, the user may need to add more or different credits in the future.

3.6.3.1 Step-by-Step Instructions

- 1) Open PCCU32, version 7.0 or later. Do not connect to the unit.
- 2) Go to the Credit Key License Utility (Operate > File Utilities > Credit Key License Utility).
- 3) Insert the credit key into an available USB port.
- 4) Select Do Phone Update (see Figure 3-30).
- 5) The user is then asked to call Totalflow Order Entry. Ensure that the credit key is plugged in.
- 6) Upon connection with a Totalflow Order Entry representative, click the OK button.
- 7) The representative will ask the user to read the five (5) encrypted codes that appear directly beneath the Do Phone Update button. Read them from top to bottom.
- 8) The representative will give the user four codes to enter in the provided fields (see Figure 3-31).

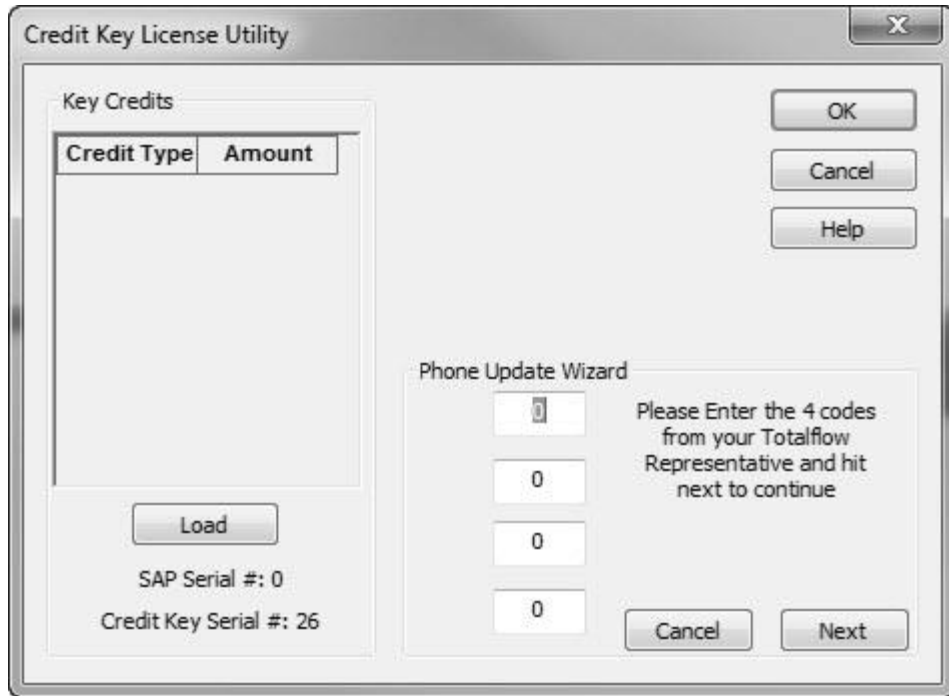

Figure 3-31 Application Credit Key Entry Screen

- 9) The representative will give the user four codes to enter in the provided fields.
- 10) After the codes have been entered (from top to bottom), click the Update button.
- 11) After the button has been clicked, three more codes are displayed directly beneath the Do Phone Update button. The Totalflow representative will ask the user to read the codes to verify that the credits have been properly written to the credit key.
- 12) When completed, click the Update button.

3.6.4 Transferring Credits to the μ FLO^{G4} from the Credit Key

Credits can be transferred to the μ FLO^{G4}. The user selects the type of credits and the amount of those credits to be transferred.



If the μ FLO^{G4} has a surplus of credits, these credits can be transferred to the credit key to be used on the other meters. This discussed in a later section.

To transfer application credits to the μ FLO^{G4}, the user will need to connect to the μ FLO^{G4} with PCCU32 7.0 or later.

3.6.4.1 Step-by-Step Instructions

- 1) Open PCCU32. Once open, move to the top of the tree-view. Click on the App Licensing tab (see Figure 3-32).
- 2) Install the credit key in an available USB port.
- 3) Click the Load button to view the available credits.



This screen enables the user to see the licensing status of the μ FLO^{G4} as well as the available credits on the credit key. The left pane shows the type and amount of the available credits on the credit key. The upper right pane is for information purposes only. It shows the various available applications and the type/amount of credits necessary to run the application. The standard credits (and one general credit) are free with the purchase of the μ FLO^{G4}. The lower right pane displays the licensing status of the μ FLO^{G4}. It shows what credits are in the machine, what credits are being used and any surplus or deficit of credits. A surplus of credits is highlighted in green. A deficit of credits is highlighted in red.

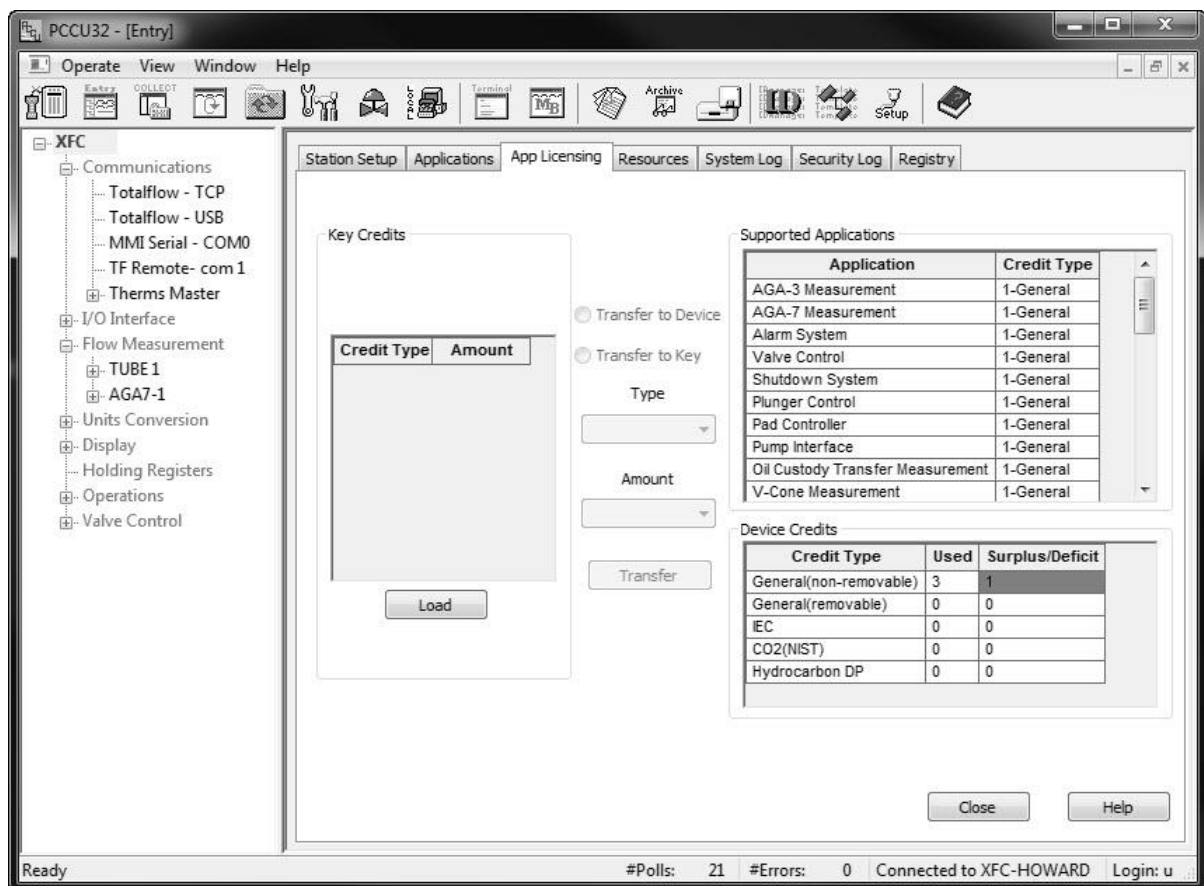

Figure 3-32 App Licensing Tab

- 4) Select the Transfer to Device radio button.
- 5) From the Type drop-down menu, select the type of credit from the available options.
- 6) Next, select the number of credits to transfer.
- 7) Upon completion, click the Transfer button.

3.6.5 Transferring Credits to the Credit Key from the μ FLO^{G4}

As previously mentioned, excess credits (credits beyond those that are required to be fully licensed) can be taken from the μ FLO^{G4} and returned to the credit key to be used on other μ FLO^{G4} devices.

TIP



If the μ FLO^{G4} has a surplus of credits, these credits can be transferred to the credit key to be used on other meters.

If the μ FLO^{G4} requires additional credits, these credits can be transferred from the credit key. See the previous section for details on how to accomplish this.

To transfer application credits to the μ FLO^{G4}, the user needs to connect to the μ FLO^{G4} unit with PCCU32, version 7.0 or later.

3.6.5.1 Step-by-Step Instructions

- 1) Open PCCU32. Once open, move to the top of the tree-view, and click on the App Licensing tab.
- 2) Install the credit key in an available USB port.
- 3) Click the Load button to view the available credits.

TIP



This screen enables the user to see the licensing status of the μ FLO^{G4} as well as the available credits on the credit key. The left pane shows the type and amount of the available credits on the credit key. The upper right pane is for information purposes only. It shows the various available applications and the type/amount of credits necessary to run the application. The standard credits (and four general credits) are free with the purchase of the μ FLO^{G4}. The lower right pane displays the licensing status of the μ FLO^{G4}. It shows what credits are in the machine, what credits are being used and any surplus or deficit of credits. A surplus of credits is highlighted in green. A deficit of credits is highlighted in red.

- 4) Select the Transfer to Key radio button (see Figure 3-33).
- 5) In the Type drop-down field, select the credit type from the available selections.
- 6) In the Amount field, set the number of credits to transfer.
- 7) Upon completion, click the Transfer button. The transferred credits will display to the left of the screen.

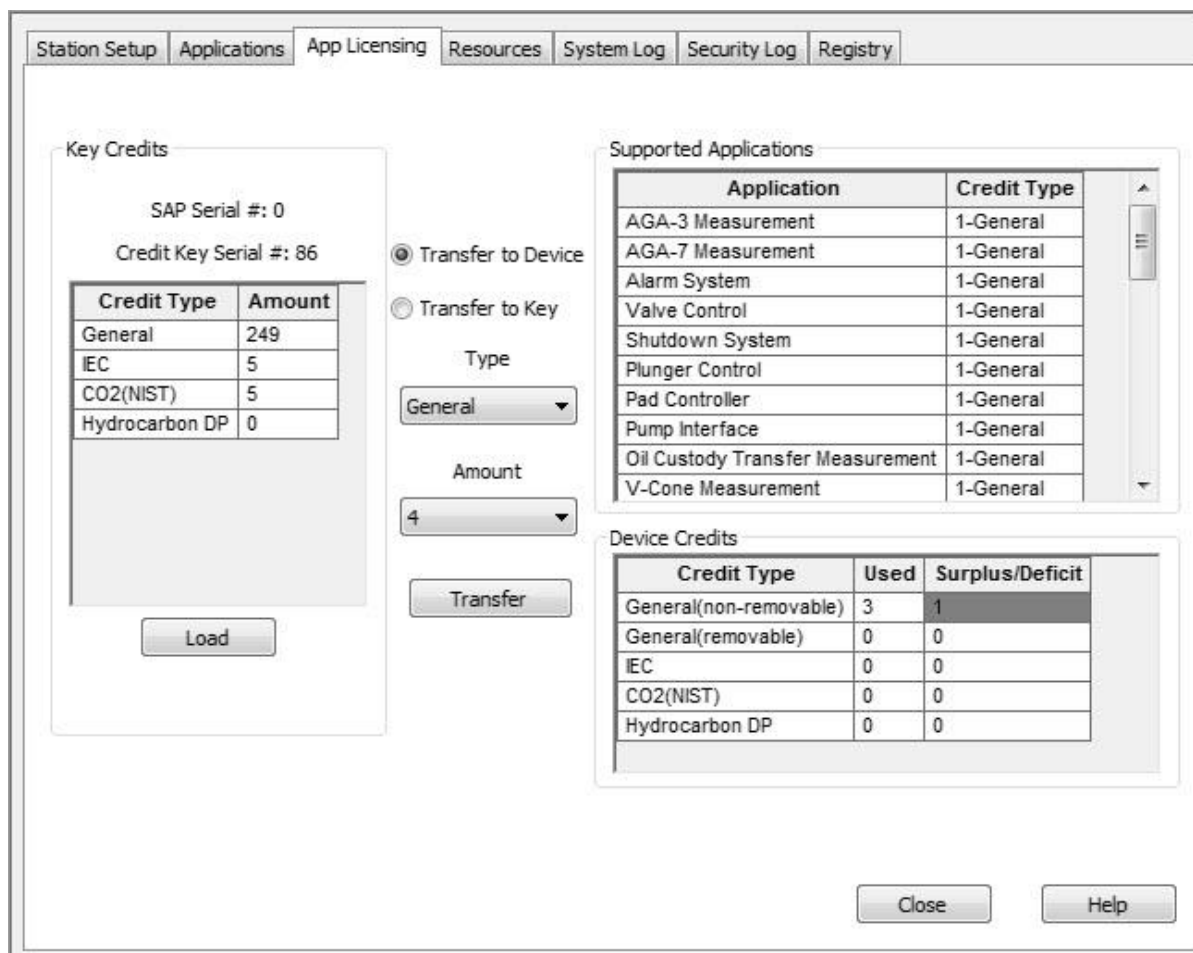

Figure 3-33 Transfer to Credit Key

3.7 μ FLO^{G4} Configuration

3.7.1 Contract Hour

The user can program the μ FLO^{G4} to begin the contract day based on their contract or company standards. When the μ FLO^{G4} first powers up, the contract is preset to begin at midnight.

FYI



Midnight is 00 o' clock. If any value entered is greater than 23, the user will receive an error message. Additionally, the μ FLO^{G4} will force the value to 00 (midnight).

3.7.2 Log Period

The Log Period is the specified time that the accumulated volume and its associated parameters are recorded. The user may record volumes as often as every minute and as seldom as every hour. The default is 60 minutes. The μ FLO^{G4} can normally store 960 log periods (40 days x 24 logs). A five-minute log period will consume available memory in eight (8) days.

Description	Options
Log Period	1, 2, 5, 10, 20, 30 60 (Minutes)

3.7.3 Volume Calculation Period

Volume Calculation Period is the specified length of time between volume calculations. The Volume Calculation Period must be equally divisible into the Log Period. The default is one (1) second.

Description	Options
Volume Calculation Period	1 second

3.7.4 Calculated Method

When the μ FLO^{G4} is powered up initially, the calculation method must be set. The user has the option of setting the calculation method to AGA-3 1985 or AGA-3 1992. Once the user has determined the calculation type, they can then toggle specific factor on or off depending upon their availability (see Table 3-1).

Table 3-1 Configurable Calculation Factors

Calculation Parameter	Configurable	
	AGA-3 1985	AGA-3 1992
Fpb (Pressure Base Factor)	Yes	N/A
Ftb (Temperature Base Factor)	Yes	N/A
Fg (Specific Gravity Factor)	Yes	N/A
Fb (Orifice Factor)	Yes	N/A
Ftf (Flowing Temperature Factor)	Yes	N/A
Y (Expansion Factor)	Yes	Yes
Fr (Reynolds Number)	Yes	N/A
Fa (Orifice Thermal Expansion Factor)	Yes	N/A
Fpv (Supercompressibility Factor) ¹	Yes	Yes
*Fw (Water Vapor Factor) ²	Yes	Yes
*Faux ³	Yes	Yes
Cd (Coefficient of Discharge)	N/A	Yes
Fp (for Fpv method = NX19 Fixed)	Yes	Yes
Ft (for Fpv method = NX19 Fixed)	Yes	Yes

A complete description can be found in the AGA Report No. 3.

¹ NX19 GCN, NX19 GCNM, AGA-8 1992 Gross and AGA-8 1992 Detail.

² Fw is not an AGA factor. Fw is a factor which compensates for water vapor in the gas stream and its affect on volume measurements.

³ Faux is not an AGA factor. Faux is a user set multiplier. It defaults to 1.

3.7.5 Super Compressibility Calculation (Fpv)

When the μ FLO^{G4} is powered up initially, the calculation method must be verified. The user has the option of selecting from several choices. The items in Table 3-2 show what factors may be used for the corresponding calculation type.

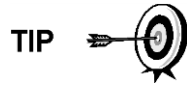

Many decisions involved with setting up the Fpv are dictated by the user's sales contract or company policy.

Table 3-2 Fpv Analysis Data

Analysis Data	Default Value	Units	NX19 Fixed Ft/Fp	AGA-8 1992 Detail	All Others ⁴
Fp (for Fpv method NX19 Fixed)	1.000		Yes	No	No
Ft (for Fpv method NX19 Fixed)	1.000		Yes	No	No
Heating Value ⁵	1000.0000	BTU/SCF	Yes	Yes	Yes
Argon	0.0000	mol %	No	Yes	No
Carbon dioxide CO2	0.0000	mol %	Yes	Yes	Yes
Carbon monoxide	0.0000	mol %	No	Yes	No
Ethane	0.0000	mol %	No	Yes	No
H2S	0.0000	mol %	No	Yes	No
Helium	0.0000	mol %	No	Yes	No
Hydrogen	0.0000	mol %	No	Yes	No
iButane	0.0000	mol %	No	Yes	No
iPentane	0.0000	mol %	No	Yes	No
Methane	100.000	mol %	No	Yes	Yes
nButane	0.0000	mol %	No	Yes	No
nDecane	0.0000	mol %	No	Yes	No
nHeptane	0.0000	mol %	No	Yes	No
nHexane	0.0000	mol %	No	Yes	No
nitrogen N2	0.0000	mol %	Yes	Yes	Yes
nNonane	0.0000	mol %	No	Yes	No
nOctane	0.0000	mol %	No	Yes	No
nPentane	0.0000	mol %	No	Yes	No
Oxygen	0.0000	mol %	No	Yes	No
Propane	0.0000	mol %	No	Yes	No
Water H2O	0.0000	mol %	No	Yes	No
Specific Gravity	0.6000	N/A	Yes	Yes	Yes

⁴ NX19 GCN, NX19 GCNM, AGA-8 1992 Gross

⁵ Enter the Heating Value in Btu per SCF. Not used in volume calculations. Only used for calculating MMBTU for reports.

3.7.6 Constants

On a single tube gas orifice meter, there are certain constants or parameters that may need to be entered or changed from the default values (see Table 3-3).

Table 3-3 Gas Orifice Constants

			Configurable	
Parameter	Default Value	Units	AGA-3 1985	AGA-3 1992
Auxiliary Factor (Faux)	1.0		Yes	Yes
Barometric Pressure		PSIA	Yes	Yes
DP zero cutoff	0.0000	Inches H2O	Yes	Yes
Meter Factor (Fb Basic Orifice Factor)	210.2300		Yes	N/A
Orifice Coefficient of Expansion	9.2500	Inches per Deg. F	No	Yes
Orifice diameter	1.0000		Yes	Yes
Orifice Material	Stainless		Yes	No
Pipe Coefficient of Expansion	6.2000	Inches per Deg. F	N/A	Yes
Pipe diameter	2.0670		Yes	Yes
Pressure Base (Contract)	14.7300	PSIA	Yes	Yes
Specific Heat Ratio	1.3000		Yes	Yes
Tap Location	Downstream		Yes	Yes
Tap Type	Flange Taps		Yes	No
Temperature Base (Tb)	60.0000	Degrees F	Yes	Yes
Viscosity	0.0103	Centipoise	Yes	Yes
Z of air at base condition	0.9996		N/A	Yes
Fixed Cd	.6		N/A	Yes

3.7.7 Alarm Limits

The user has the ability to set the $\mu\text{FLO}^{\text{G4}}$ Alarm Limits for the parameters listed in Table 3-4. There are many purposes for setting these limits, i.e., controlling well output or sending digital signals.

Table 3-4 Alarm Limits

			Configurable	
Parameter	Default Value	Units	AGA-3 1985	AGA-3 1992
DP High Limit	2047.9688	In H2O	Yes	Yes
DP Low Limit	0	In H2O	Yes	Yes
Flow Rate High Limit	1,000,000	SCF/Hr	Yes	Yes
Flow Rate Low Limit	0	SCF/Hr	Yes	Yes
RTD High Limit	420	Degrees F	Yes	Yes

			Configurable	
RTD Low Limit	0	Degrees F	Yes	Yes
SP High Limit	2047.9688	PSIA	Yes	Yes
SP Low Limit	0	PSIA	Yes	Yes

3.7.8 Reset Volume

When the user resets the volume accumulator, the $\mu\text{FLO}^{\text{G4}}$ will:

- Store time, date and previous accumulated partial calc period volumes into the historical record file.
- Zero the remaining partial calc period accumulations.
- Complete all computations for the present flow file daily records.
- Begin a new flow file daily record.
- Zero the total volume accumulator. Log the event with an accumulator value before zeroing the accumulator.

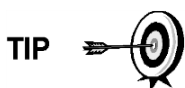

TIP

Since the $\mu\text{FLO}^{\text{G4}}$ volume calculations are made each vol calc period, any changes that are made during the period would affect the volume calculations (such as changing the orifice plate size) and be introduced into the calculations. To avoid introduced errors, it is recommended that the Reset Volume command be used. This command forces the $\mu\text{FLO}^{\text{G4}}$ to perform volume calculations for the elapsed time since a previous volume calculation was made. A new partial period volume is added to the volume accumulator. This is logged as an event before it is reset to zero (0).

3.8 Start Up the $\mu\text{FLO}^{\text{G4}}$

3.8.1 Putting the $\mu\text{FLO}^{\text{G4}}$ On-Line



CAUTION

To avoid a calibration shift, carefully follow these instructions.

3.8.1.1 Step-by-Step Instructions

- 1) Open both the bypass valves, and close the vent to the atmosphere valve. This stabilizes the pressure on both sides of the cell.
- 2) Begin to slowly open the high side orifice tap valve from the meter run.
- 3) Begin to slowly open the low side valve.
- 4) Once both the high and low sides are completely open, close both bypass valves.

3.8.2 Setting the $\mu\text{FLO}^{\text{G4}}$ Temperature Calculation

The $\mu\text{FLO}^{\text{G4}}$ temperature calculation can be set to the following conditions:

- RTD Installed – This uses the RTD temperature input and stores the RTD temperature. If the RTD fails, the Fixed TF value is used.
- Used Fixed TF – This uses and stores the fixed temperature.

3.9 μ FLO^{G4} Standard Displays

3.9.1 Program Display

The single tube μ FLO^{G4} comes from the factory with a set of default displays (see Table 3-5). By default, each display item remains on the display for five (5) seconds. The user has the ability to change this default to zero (item not displayed) or any value from 1 to 255 seconds. The user is also able to change the engineering units and data format for display purposes. Further instructions on programming the display system can be found in the PCCU32 help files. All display items and item groups are user programmable and may be displayed by user-defined parameters.

Table 3-5 μ FLO^{G4} Displayed Items

Display	Description
Station	
STATION ID	ID of unit
DATE/TIME MM/DD/YY HH:MM:SS	Current date and time, 24-hour clock
CHARGER	Input voltage of the charging circuit
BATTERY VOLTAGE	Battery voltage as supplied by external unit
LITHIUM BACKUP	Display showing condition of the lithium battery
Tube	
TUBE # ID	ID of the tube
TUBE # ORIFICE DIAMETER INCHES	N.NNNN Size of orifice plate
TUBE # SP	Static pressure absolute, PSIA
TUBE # DP H2O	NNN.N.IN. Differential pressure, inches H2O
TUBE # TEMPERATURE F	NN.N DEG. Flowing temperature, °F
TUBE # FLOW RATE SCF/HR	NNNNNN.N Current flow rate, programmable SCF, MCF or MMCF
TUBE # LAST CALC	Last calculated volume
TUBE # YEST VOL MCF	NNNN.N Yesterday's volume, programmable SCF, MCF or MMCF
TUBE # ACCUM VOL MCF	NNNNNN.NN Total accumulated volume, programmable SCF, MCF or MMCF
DP HIGH	(Optional) Percentage of the day that the DP spent in a high status

DP LOW	(Optional) Percentage of the day that the DP spent in a low status
--------	--

4.0 MAINTENANCE

4.1 Overview

The following chapter will provide the user with standard maintenance information and instructions on how to remove and install μ FLO^{G4} components.



For all Maintenance steps, remove power from the device, or ensure that the area is known to be non-hazardous before removing the enclosure cover or before breaking or making connections. For further information, refer to the certification drawing indicated on the device's name tag and national and local codes.

4.1.1 Maintenance Support

If installation, calibration and/or maintenance assistance is required, the user can contact the ABB Totalflow Service Department:

USA: (800) 442-3097

International: 001-918-338-4888

4.1.2 How to Use This Chapter

It is recommended that the user develop a regularly scheduled maintenance program. By establishing a maintenance program, the μ FLO^{G4} downtime can be minimized. Practical experience permits the updating of a maintenance program over a period of time. This results in many maintenance items being handled on a routine basis before potential problems result in a failure.

4.1.3 Cleanliness

Because a μ FLO^{G4} installation is primarily exposed to external environmental conditions, it is important that it be regularly inspected for cleanliness, both externally and internally. Foreign contaminants can cause damage to interior mounted components that can render the μ FLO^{G4} inoperable.

4.1.4 Front-Mounted LCD

The user is informed of operational problems and operational limit violations by observing the alarm codes on the LCD display. Troubleshooting techniques for dealing with these alarm codes is presented later in the manual.

4.1.5 Returning Parts for Repair

If an ABB Totalflow component is to be returned to ABB Totalflow for repair, securely wrap it in protective, anti-static packaging. Before returning a component, call ABB Totalflow for a Return for Authorization (RA) number. Affix this number to the outside of the return package.

Part shipments must be prepaid by the customer. Any part that is not covered by the original system warranty will be shipped to the customer, F.O.B.

4.2 μ FLO^{G4} Component Breakdown

Figure 4-1 displays an exploded view of the μ FLO^{G4} device

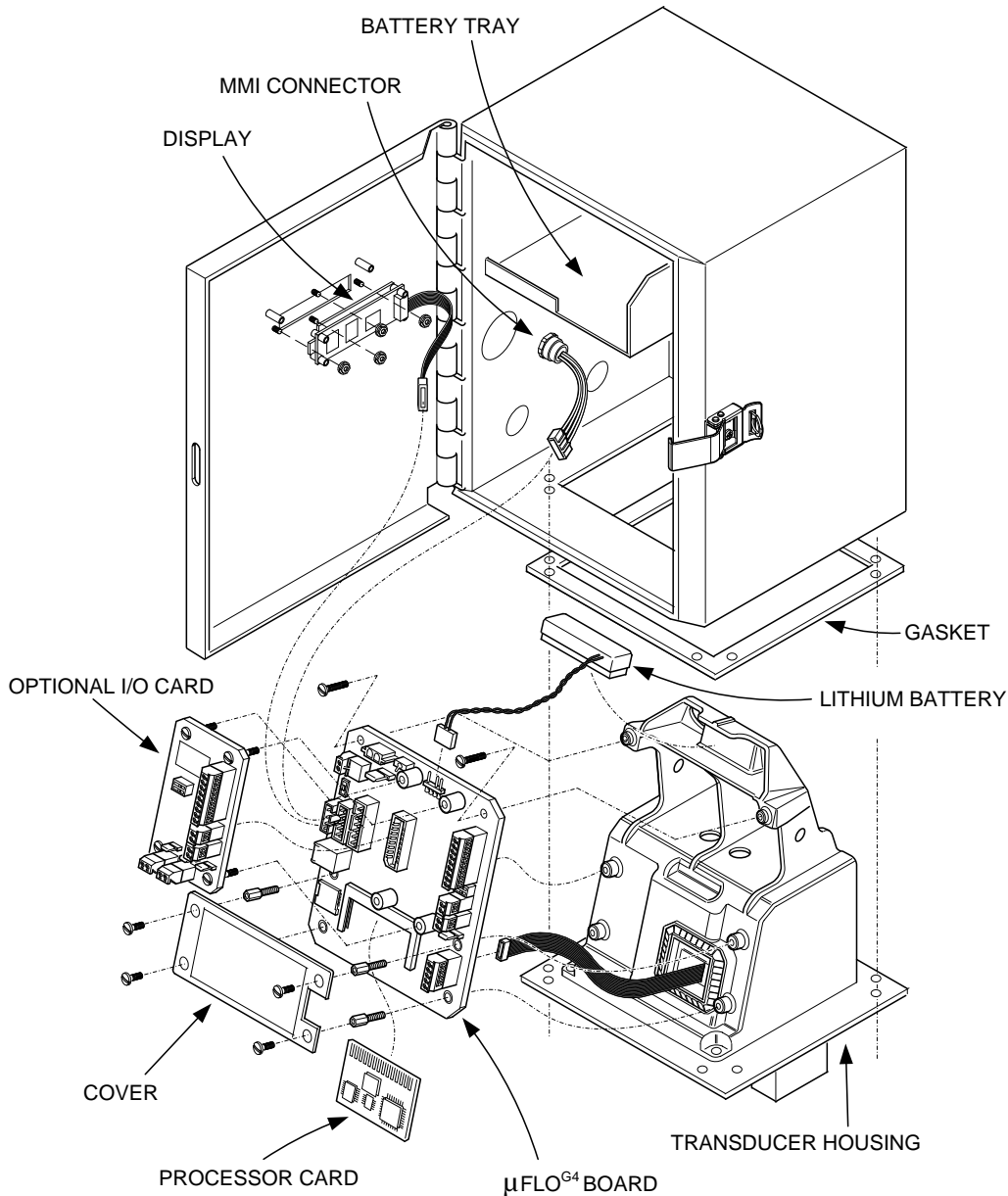

Figure 4-1 μ FLO^{G4} Exploded View

4.3 Backing Up Configuration Files

Before beginning any maintenance on the μ FLO^{G4}, the user should first collect the data. Upon completion, back up all configuration files to the laptop's hard drive or disk. This upload safeguards data and allows the user to restart the unit without the obstacles associated with reconfiguring the μ FLO^{G4} should any problem arise.

Although there are Save buttons within the Entry mode screens in PCCU32 that allow the user to back up Entry model data items, a complete system backup is only accomplished by using the Save and Restore Utility or the 32-Bit Loader. When using this utility to back up files, the user should also download the files to the tfCold drive in the event of a cold start.

4.3.1 Step-by-Step Instructions

- 1) Collect the data from the unit.
- 2) While in PCCU32, click the Save and Restore Utility icon in the main window toolbar.
- 3) When the Save and Restore window displays, click the Save Station Files button. The Save Station Files dialog box will display.
- 4) When the Save Station Files dialog box displays, verify the default name and path for the files. Click the OK button. This will save the tfData drive files.
- 5) When finished saving the station files, a new dialog box offers the user the option to restore the station files to the tfCold drive. If the user selects the Yes button, the station files will be downloaded to the tfCold drive.

4.4 Restoring Configuration Files

The Restore function enables the user to download configuration files to the μ FLO^{G4}.

If, prior to performing maintenance, the Save Configuration Files was used, these files were downloaded to the laptop's hard drive or disk. The Restore function downloads these files into the μ FLO^{G4}'s tfCold drive. This safeguards the data and allows the user to restart the unit without the obstacle of reconfiguring the μ FLO^{G4} should any problem arise.

4.4.1 Step-by-Step Instructions

- 1) While the user is in PCCU32, click the Save and Restore Utility icon on the window's main toolbar.
- 2) When the Save and Restore window displays, click the Restore Station Files button. The Restore Station Files dialog box will display.
- 3) When the Restore Station Files dialog box displays, verify the default name and file path. Click the OK button. This will restore the files to the tfCold drive.
- 4) Verify that the unit is functioning properly.

4.5 Performing a Warm Boot

A warm boot signifies that the user has cycled power off the board without disconnecting the lithium battery. This method enables the user to not lose any stored data. A warm boot can be initiated from a hardware or software standpoint. The following will take the user through the steps for both methods.

4.5.1 Hardware Warm Boot

There are two methods of warm booting the system from a hardware standpoint.

4.5.1.1 Method 1

- 1) The user will need to open the door to the unit. Locate the Reset button (S2) on the μ FLO^{G4} board (see Figure 4-2).

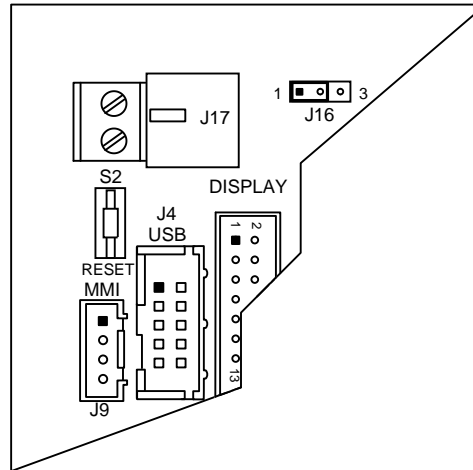

Figure 4-2 Reset Button Location

- 2) Upon location, press the Reset button for approximately five seconds. The unit will warm boot.

4.5.1.2 Method 2

- 1) Open the door to the unit. Ensure that there is voltage on the lithium battery.

FYI



If this condition is not met, do not attempt a warm boot. Continuing with this process without this condition being met will result in a cold boot. At that point, all historical data will be lost.

- 2) Remove power to board, and then reconnect. This will initiate a warm boot.

4.5.2 Software Warm Boot

There are three methods of warm booting the system from a software standpoint.

4.5.2.1 Method 1

- 1) Open PCCU32. The user needs to ensure that they are not connected initially and are at the Totalflow splash screen.
- 2) Click the 32-Bit Loader icon on the main window toolbar. This takes the user to the 32-Bit Loader screen.
- 3) Within the screen, the user needs to select the Reload radio button.
- 4) Ensure that all of the checkmarks are removed from the various software options. Once this has been accomplished, place a check in the options list beside Shutdown Flash and Start Flash.
- 5) Select the needed connection type from the Connection drop-down menu.
- 6) Upon completion, click the Start button.

FYI



There is a chance that the user will see a PCCU32 dialog box display that informs them that the Target Device Loader is not working. The user will need to follow the dialog box instructions to warm boot the system.

4.5.2.2 Method 2

FYI



The user will need to be in Expert view.

- 1) Move into Entry mode within PCCU32.
- 2) Upon completion, click on the Meter ID in the PCCU32 tree-view. By default, this will take the user to the Station Setup tab.
- 3) Locate the System Shutdown/then Reset parameter field. Once located, set the parameter value to Yes.
- 4) Click the Send button. This will initiate a warm boot.

4.5.2.3 Method 3

- 1) Move into Entry mode within PCCU32.
- 2) Once this has been completed, click the Terminal icon on the PCCU32 window toolbar. This will bring up the Terminal window.
- 3) Once in the Terminal window, move to the terminal prompt (->), and type in the following: `BOOT=WARM`. Press Enter on the keyboard to initiate the warm boot.

4.6 Performing a Cold Boot

A cold boot occurs when the user cuts power to the board, including the lithium battery backup. This causes a loss of all historical data. A cold boot can be initiated from a hardware or software standpoint. The following will take the user through both methods.

4.6.1 Hardware Cold Boot

- 1) Open the door to the unit. Locate the lithium battery connector (see Figure 4-3).
- 2) Upon location, disconnect the battery.
- 3) Press the Reset button for approximately five seconds. The unit will cold boot.

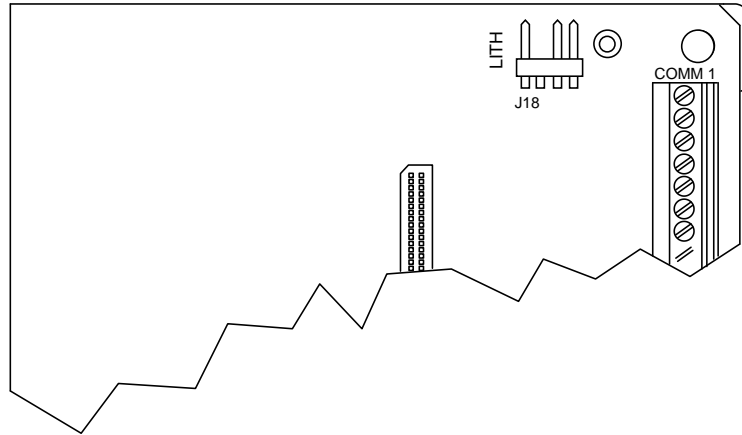

Figure 4-3 Lithium Battery Connector

4.6.2 Software Cold Boot

There are two methods for initiating a software cold boot.

4.6.2.1 Method 1

- 1) Open PCCU32. The user needs to ensure that they are not connected initially and are at the Totalflow splash screen.
- 2) Click the 32-Bit Loader icon on the toolbar. This takes the user to the 32-Bit Loader screen.
- 3) Within the screen, the user needs to select the Reload radio button.
- 4) Make sure that all of the checkmarks are removed from the various software options. Once this has been accomplished, place a check in the options list beside Shutdown Flash, Delete tfData and Start Flash. A prompt will display that warns that a cold boot is occurring. Click the Yes button to initiate a cold boot.

FYI



There is a chance that the user will see a PCCU32 dialog box display that informs them that the Target Device Loader is not working. The user will need to follow the dialog box instructions to cold boot the system.

4.6.2.2 Method 2

- 1) Move into Entry mode within PCCU32.
- 2) Once this has been completed, click the Terminal icon on the PCCU32 window toolbar. This will bring up the Terminal window.
- 3) Once in the Terminal window, move to the terminal prompt (->), and type in the following: `BOOT=COLD`. Press Enter on the keyboard to initiate the warm boot.

4.7 Changing the μ FLO^{G4} Clock

When any measurement applications are turned on within the μ FLO^{G4}, changing the clock could affect the time when log period entries are made. To protect the

integrity of accounting audit trails, the μ FLO^{G4} handles these types of clock changes as follows:

4.7.1 Clock Change Not Crossing an Hourly Boundary

When the next log period entry is made, the clock is not altered.

Example: If the present time is 4:15 p.m. and clock is changed to 4:05 p.m. of the same day, the daily flow record is the same. Entry reflects averages accumulated over a 70-minute time period (15 minutes plus 55 minutes).

4.7.2 Forward Clock Change Crossing an Hourly Boundary

This forces a log period entry for part of the hour that has accumulated since the last hourly entry. The μ FLO^{G4} then advances to the newly defined data flow record boundary and begins to maintain the balance of the day's data in a newly defined boundary.

Example: If the present time is 4:55 p.m. and the clock is changed to 5:05 p.m. of the same day, the entry reflects only a 55-minute average accumulation. A new flow record is then written. This period is also based on a 55-minute accumulation.

4.7.3 Backward Clock Change Crossing an Hourly Boundary

This hourly entry is made for part of the hour that has accumulated since making the last hourly entry. This is the same as a Forward Clock Change Crossing an Hourly Boundary. The μ FLO^{G4} advances to a new day's data flow record and maintains the balance of the day's data in a new record.

Example: If the present time is 5:05 p.m. and the clock is changed to 4:55 p.m. of the same day, the log period entry reflects only a five-minute average accumulation. A new flow record is then written. This log period is based on a 60-minute accumulation.

FYI



A backward clock change uses two (2) records to maintain data integrity. This ensures that previously recorded data is not overwritten.

If it is necessary to make small, backward time changes of less than one (1) hour, the user should wait until the current hour has progressed far enough to make a change that does not cross an hour boundary.

4.8 Replacing the μ FLO^{G4} Battery Pack

The following section presents the procedures for removal and installation of the μ FLO^{G4} battery pack. To access the battery pack, open the μ FLO^{G4} door. The battery pack is located in the upper portion of the chamber (see Figure 4-1).

FYI



To extend the life of the battery pack, fully charge the battery prior to installation. A system using solar panels may not fully charge the battery. Additionally, a fast charge, which the solar panel cannot provide, improves the life of the battery.

To recharge a battery, a quick charge will remove buildup in the battery much more effectively than a trickle charge. A battery slowly drained by low light conditions on a solar-charged system or sitting in storage will be less likely to recover than a battery pack that was quickly discharged from a short. Store batteries in a cool environment for less drainage.



When removing the battery pack, DO NOT remove the lithium battery from the μ FLO^{G4} board. This prevents any data stored in board's RAM from being lost.

4.8.1 Step-by-Step Instructions

- 1) Collect data from the unit.
- 2) Back up the configurations files. Use the procedures detailed previously in the Backing Up the Configuration Files section.
- 3) Ensure that J16 jumper covers 1 and 2 (see Figure 4-4).
- 4) Verify the "L" battery alarm is not being displayed on the μ FLO^{G4}. If it is being displayed, ensure that the lithium battery is connected (J18). If it is connected, the lithium battery may need to be replaced. Otherwise, measure the lithium battery. Make sure that it is > 3.0 V.

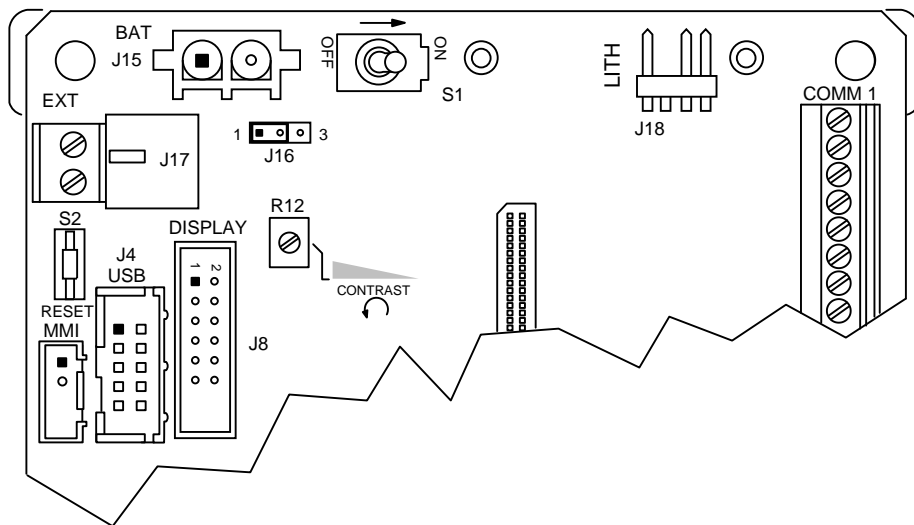

Figure 4-4 μ FLO^{G4} Board Cutout Maintenance

- 5) Disconnect the battery cable from J15 on the μ FLO^{G4} board (see Figure 4-4). If applicable, disconnect power to the charger (J17).
- 6) Remove the battery pack from the battery compartment.
- 7) Insert the new battery pack into the battery compartment. Ensure that the battery pack's terminals are not touching either the keeper lip on the shelf or any metal surface inside of the unit (see Figure 4-5).

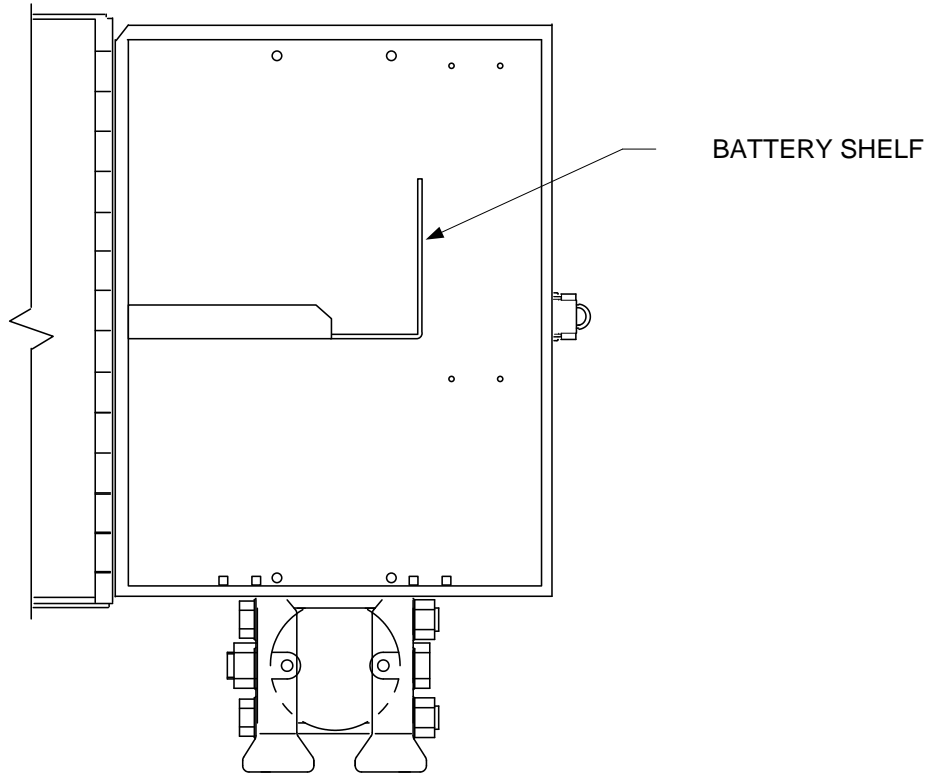

Figure 4-5 Battery Shelf

- 8) Reconnect the battery pack cable to J15 on the μ FLO^{G4} board.
- 9) After closing the μ FLO^{G4} door, check the door mounted LCD for normal operational readings.

4.9 Replacing the μ FLO^{G4} Board

The μ FLO^{G4} board is mounted on the transducer housing. To access and remove the μ FLO^{G4}, perform the following procedures (see Figure 4-1). There are two sets of instructions: With the Engine Card Attached to the New Board or Retaining the Old Engine Card with a New Board.



Installation or maintenance of electric components should follow guidelines stipulated in the certification drawings shipped with this unit and adhere to national and local codes.

4.9.1 Step-by-Step Instructions (Engine Card Attached)

- 1) Collect data from the unit.
- 2) Back up the configurations files. Use the procedures detailed previously in the Backing Up the Configuration Files section.
- 3) Verify the “LL” battery alarm is not being displayed on the μ FLO^{G4}. If it is being displayed, ensure that the lithium battery is connected (J18). If it is connected, the lithium battery may need to be replaced.
- 4) Disconnect the battery charger from the μ FLO^{G4} motherboard terminals: EXT (J17).
- 5) Disconnect the battery cable from the μ FLO^{G4} board connector (J15).

- 6) Gently disconnect the LCD display cable from its μ FLO^{G4} board (J8) connector.



Removing the lithium battery results in a loss of data in the battery-back up RAM

- 7) Remove the lithium battery cable (J18) from the μ FLO^{G4} board.
- 8) Remove any field wiring.
- 9) Take off the protective plate by removing the four (4) attachment screws. Use a Phillips-head screwdriver.
- 10) Gently remove the protective plate.
- 11) Next, the user will need to remove the six (6) hex standoffs that attach the μ FLO^{G4} board to the transducer housing. Using a socket wrench, unscrew the six hex standoffs holding the μ FLO^{G4} board in place.
- 12) On the back of the μ FLO^{G4} board is a ribbon cable that connects the board to the raw sensor board within the transducer housing. Gently disconnect the ribbon cable from the μ FLO^{G4} board.
- 13) Attach the ribbon cable from the raw sensor board to the respective connector on the back of the μ FLO^{G4} board.
- 14) Take the replacement μ FLO^{G4} board and align the mounting holes with their respective standoffs.
- 15) Using the socket wrench, tighten the six hex standoffs. This will attach the μ FLO^{G4} board to the transducer housing.
- 16) Take the lithium battery cable and attach the cable to its corresponding connector (J18).
- 17) Connect the LCD display cable to its corresponding connector (J8) on the μ FLO^{G4} board.
- 18) After this has been completed, take a Phillips-head screwdriver and attach the protective plate to the μ FLO^{G4} board with the four Phillips-head screws.
- 19) Reattach the LCD display assembly with the remaining two (2) screws.

4.9.2 Step-by-Step Instructions (Retaining Original Engine Card)



Removing the engine card results in a loss of data in the battery-back up RAM

4.9.3 Step-by-Step Instructions

- 1) Collect data from the unit. Upon completion, back up the configuration files.
- 2) When these tasks have been completed, verify the "LL" battery alarm is not being displayed on the μ FLO^{G4}. If it is being displayed, ensure that the lithium battery is connected (J18). If it is connected, the lithium battery may need to be replaced.
- 3) Disconnect the battery cable from the μ FLO^{G4} board terminals: EXT (J17).
- 4) Disconnect the battery cable from the μ FLO^{G4} board connector (J15).
- 5) Gently disconnect the LCD display cable from the μ FLO^{G4} board connector (J8).
- 6) Remove the lithium battery cable (J18) from the μ FLO^{G4} board.
- 7) Remove any field wiring.

- 8) Take off the protective plate by removing the four (4) attachment screws. Use a Phillips-head screwdriver.
- 9) Gently pull back the attachment brackets that hold the engine card in place. Simultaneously, unsnap the engine card from its housing. The engine card springs up out of the μ FLO^{G4} motherboard at a 30-degree angle. It should require very little force to accomplish this task.
- 10) Next, the user needs to remove the six (6) hex standoffs that attach the μ FLO^{G4} board to the transducer housing. Using a socket wrench, unscrew the six hex standoffs holding the μ FLO^{G4} board in place.

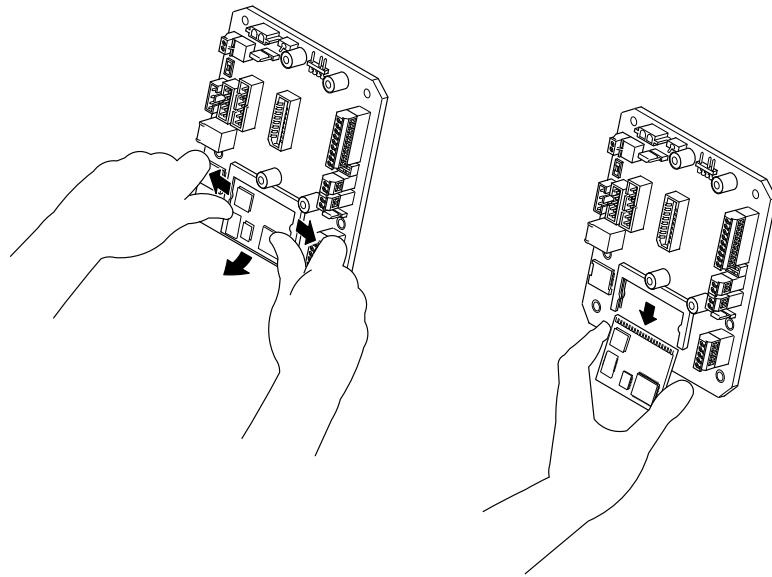

Figure 4-6 Engine Card Removal

- 11) On the back of the μ FLO^{G4} board is a ribbon cable that connects the board to the raw sensor board within the transducer housing. Gently disconnect the ribbon cable from the μ FLO^{G4} board.
- 12) Attach the ribbon cable from the raw sensor board to the respective connector on the back of the new μ FLO^{G4} board.
- 13) Take the replacement μ FLO^{G4} board and align the mounting holes with their respective standoffs.
- 14) Using the socket wrench, tighten the six hex standoffs. This attaches the μ FLO^{G4} board to the transducer housing.
- 15) To replace the engine card in the new μ FLO^{G4} board, insert the engine card at the same 30-degree angle. The user should press the engine card in until they are unable to see the gold-plated edge connector pins at the top of the engine card.
- 16) When the engine card has been fully inserted, press the engine card down toward the μ FLO^{G4} board. It should snap into the connector.

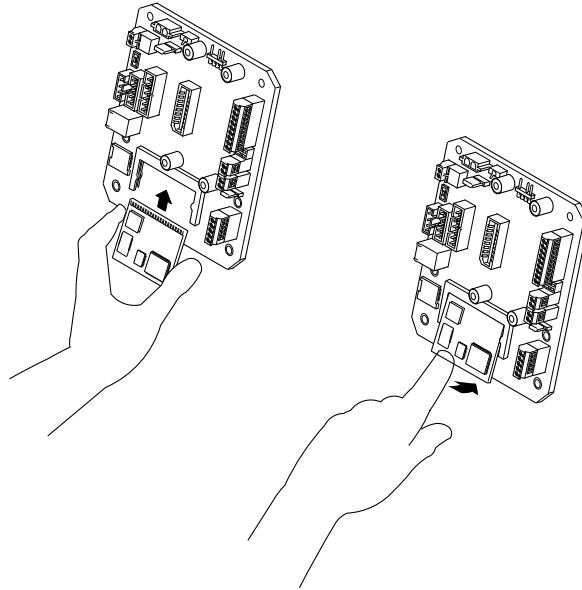



Figure 4-7 Engine Card Installation

- 17) Attach the lithium battery cable to the corresponding connector (J18) on the $\mu\text{FLO}^{\text{G4}}$ board.
- 18) Connect the LCD display cable to its corresponding connector (J8) on the $\mu\text{FLO}^{\text{G4}}$ board.
- 19) Upon completion, take a Phillips-head screwdriver and attach the protective plate to the $\mu\text{FLO}^{\text{G4}}$ board with the four Phillips-head screws.
- 20) Reattach the LCD display assembly with the remaining two screws.

4.10 Replacing the Optional I/O Card

The optional I/O card attaches directly to the $\mu\text{FLO}^{\text{G4}}$ board. The following procedures will walk the user through the steps for replacing the card (see Figure 4-1).

CAUTION  During the installation of the I/O card, alternate between the tightening of the four captive screws, one to two turns. Failure to do so will cause the board to bow and possibly break.

4.10.1 Step-by-Step Instructions

- 1) Collect data from the unit.
- 2) Back up the configurations files. Use the procedures detailed previously in the Backing Up the Configuration Files section.
- 3) Verify the “L” battery alarm is not being displayed on the $\mu\text{FLO}^{\text{G4}}$. If it is being displayed, ensure that the lithium battery is connected (J18). If it is connected, the lithium battery may need to be replaced.
- 4) Remove any field wiring.
- 5) Using a flat-head screwdriver, remove the four (4) flat-head screws that attach the I/O card to the $\mu\text{FLO}^{\text{G4}}$ board. Alternate between the four screws, one to two turns each. The J2 connector is gradually disconnected as the screws are loosened.

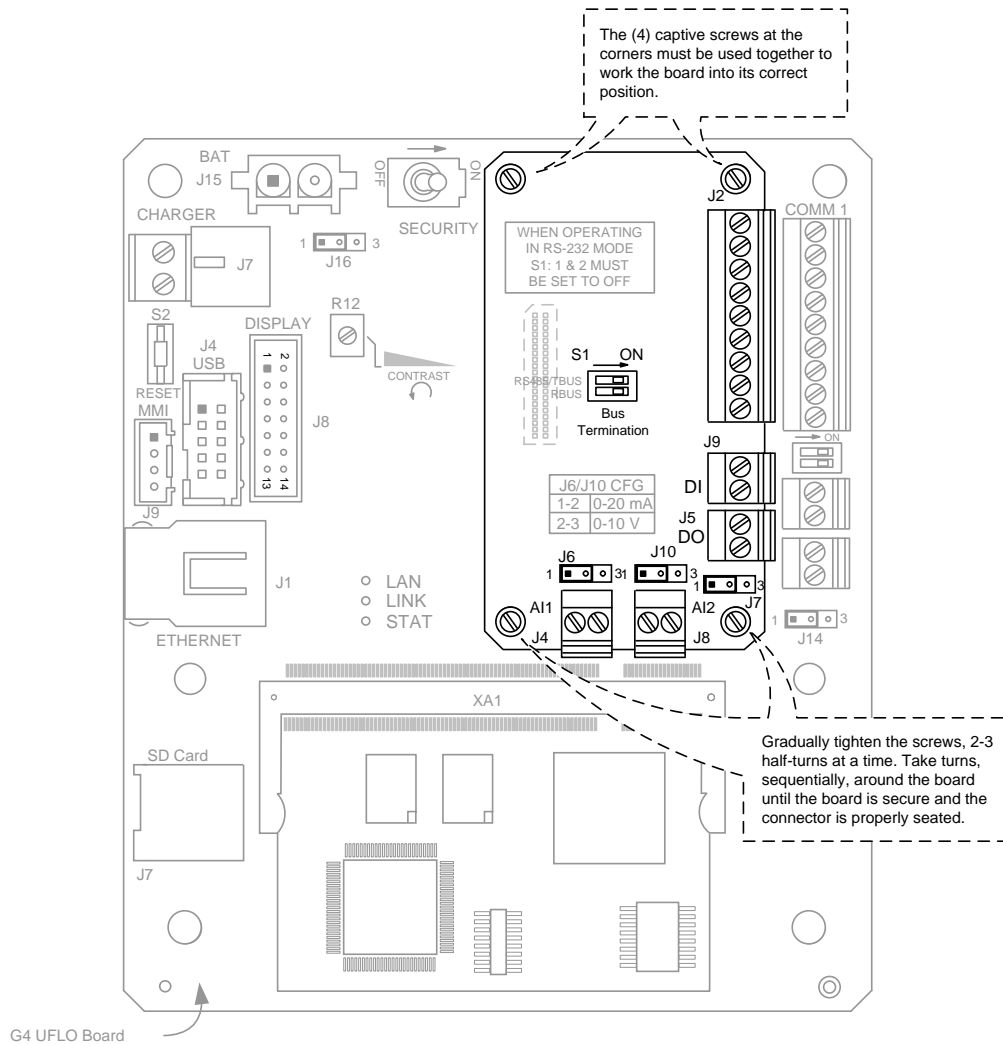

Figure 4-8 μ FLO^{G4} Board – J2 Connector

- 6) Place the I/O daughter card on the standoffs. Alternate tightening the screws, one to two turns, until the I/O daughter card is secure.

4.11 Replacing the Liquid Crystal Display (LCD)

The LCD board is mounted on the backside of the hinged door. The following procedure will walk the user through the steps necessary for removing the LCD board (see Figure 4-1).



CAUTION DO NOT remove the μ FLO^{G4} lithium battery, as it provides power to the RAM. It is recommended that historical flow data be downloaded before accessing and removing the LCD board to prevent the loss of stored data.

4.11.1 Step-by-Step Instructions

- 1) Collect data from the unit.
- 2) Back up the configurations files. Use the procedures detailed previously in the Backing Up the Configuration Files section.

- 3) Verify the “L” battery alarm is not being displayed on the μ FLO^{G4}. If it is being displayed, ensure that the lithium battery is connected (J18). If it is connected, the lithium battery may need to be replaced.
- 4) To access the LCD board, open the μ FLO^{G4} unit’s door. The board is located on the inside of the door.
- 5) Disconnect the battery charger from the μ FLO^{G4} board terminals: CHARGER +/-, J17 (see Figure 4-4).
- 6) Disconnect the battery cable from the μ FLO^{G4} board connector, J15 (see Figure 4-4).
- 7) Disconnect the μ FLO^{G4} LCD port connector, J8 (see Figure 4-4).
- 8) Using a 3/16” nut driver, remove the four display board hexagon mounting standoffs. Lift the board from the door-mounted standoffs.
- 9) Install the replacement LCD, and secure with the standoffs. Be careful not to over-tighten the nylon standoffs. Doing so could cause damage to the board and associated circuitry.
- 10) Reconnect the LCD port connector, J8 (see Figure 4-4).
- 11) Reconnect the battery cable to the μ FLO^{G4} board connector, J15 (see Figure 4-4).
- 12) Reconnect the battery charger to EXT CHGR +/-, J17 (see Figure 4-4).
- 13) Once the unit has powered up, it may be necessary to adjust the LCD contrast.

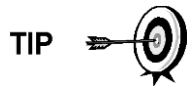

To adjust the display contrast, use an extra small screwdriver to turn the potentiometer, R12, completely clockwise. Upon completion, move the screw back counter-clockwise until the screen is readable.

4.12 Replacing the Lithium Battery



Do not remove power to the unit. Loss of power to the unit will initiate a cold start. All data and configuration files will be lost.

4.12.1 Step-by-Step Instructions

- 1) Collect data from the unit.
- 2) Back up the configurations files. Use the procedures detailed previously in the Backing Up the Configuration Files section.
- 3) On the μ FLO^{G4} board, gently remove the lithium battery cable from the lithium battery connector (J18). See Figure 4-9 for the location of J18.

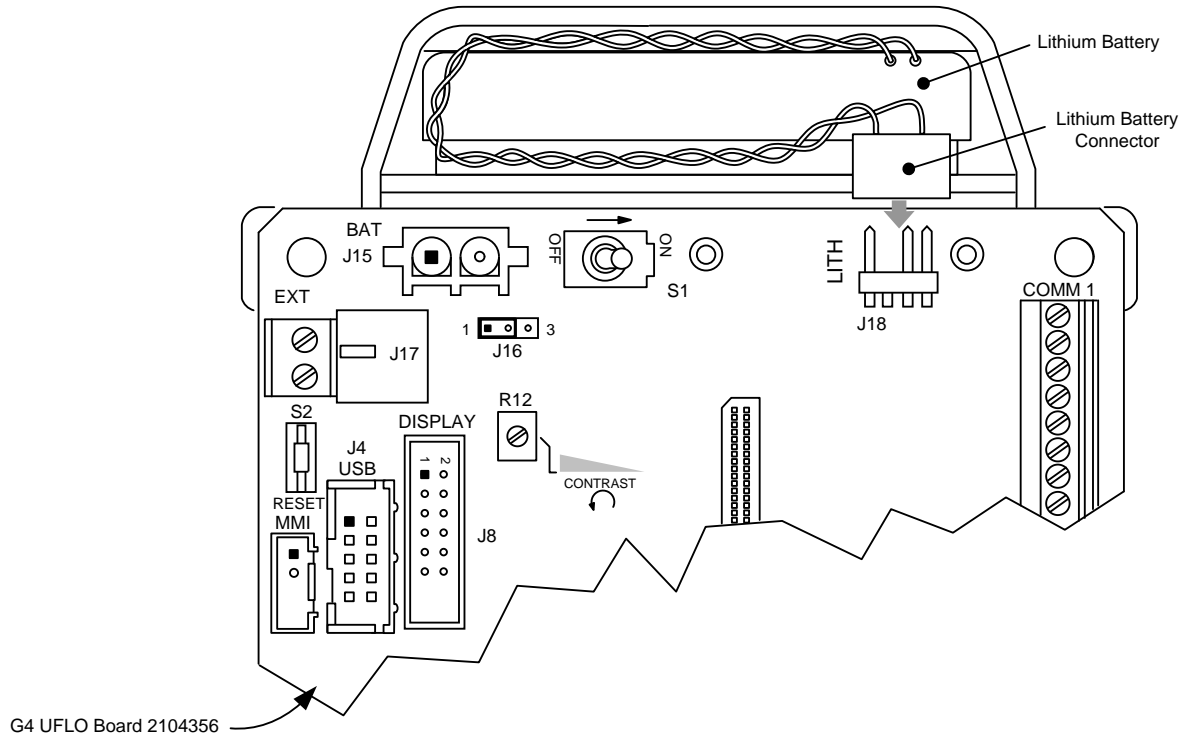

Figure 4-9 Lithium Battery Cable and Connector

- 4) The lithium battery is housed in the top portion of the transducer housing and is held in place with a Velcro strip. Using care, remove the lithium battery from its compartment.
- 5) Take the new lithium battery and attach the Velcro edge of the battery to the Velcro strip within the enclosure.
- 6) Next, take the lithium battery cable and attach it to the lithium battery connector (J18).

4.13 Replacing the IMV

4.13.1 Step-by-Step Instructions

- 1) Collect data from the unit.
- 2) Back up the configuration files. Use the procedures detailed previously in the Backing Up Configuration Files section.
- 3) Verify the “LL” battery alarm is not being displayed on the μ FLO^G. If it is being displayed, ensure that the lithium battery is connected (J18). If it is connected, the lithium battery may need to be replaced. Otherwise, measure the lithium battery, and ensure that it is > 3.0 V.
- 4) Disconnect the battery charger from the μ FLO^{G4} board terminals: CHARGER +/- (J17) (see Figure 4-4).
- 5) Disconnect the battery cable from the μ FLO^{G4} board connector, J15 (see Figure 4-4).
- 6) Remove any field wiring.

- 7) Remove the six (6) mounting screws, and gently lift the μ FLO^{G4} motherboard from the transducer. On the back of the μ FLO^{G4} motherboard is a ribbon cable that connects the board to the raw sensor board within the transducer housing. Gently disconnect the ribbon cable from the μ FLO^{G4} motherboard.
- 8) Using the meter run-installed manifold high/low control valves, equalize the pressure to the IMV.
- 9) Using the high/low tap valves, close off both lines. These two valves connect the meter run high/low output lines to the μ FLO^{G4}.
- 10) Vent the manifold to atmosphere using the vent valve.
- 11) Completely disconnect the high/low manifold lines from the IMV.
- 12) Loosen the μ FLO^{G4} mounting clamps. Upon completion, rotate the μ FLO^{G4} to a sufficient distance to allow the removal of the IMV. Clearance of approximately 11" is required for removal. After rotation, tighten the clamps to hold the μ FLO^{G4} in place before removing the IMV.



When rotating the μ FLO^{G4}, be careful not to place twisting stress on the attached cables.

- 13) Using a Phillips-head screwdriver, remove the eight (8) mounting screws, washers and lock washers securing the IMV to the μ FLO^{G4} cabinet. Access the mounting hardware from the bottom of the μ FLO^{G4}. Be careful when removing the final screws.
- 14) Tilt the IMV slightly upwards. Upon completion, remove the unit.
- 15) A weather-sealing gasket is affixed to the top side of the IMV mounting flange. Remove any remaining gasket that is adhered to the bottom of the cabinet.

FYI



The bottom of the cabinet should be clean and free of any materials that may keep the new gasket from sealing during the installation of the replacement IMV.

- 16) When installing the IMV, the eight mounting screws should be securely tightened to keep out external environmental elements.
- 17) To install the IMV, perform steps 10 thru 13 in the remembered order
- 18) Reconnect power by performing steps 4 and 7 in reverse order.

TIP



Before placing the unit into operation, the μ FLO^{G4} must be calibrated. Refer to section on Calibration later in this chapter.

4.14 Calibration

The Calibration mode enables the user to calibrate, check and zero the static and differential pressure. Additionally, this mode allows the user to calibrate or set the bias for the resistance temperature detector (RTD). During the initial calibration, the parameters in Table 4-1 will need to be configured.

Table 4-1 Calibration Configurable Parameters

Parameter	Default Value	Units
-----------	---------------	-------

RTD Installed	No	
RTD Bias	0.00	Degrees F
Use Fixed Temperature(TF)	No	
Fixed Temperature	60.000	Degrees F

4.14.1 Required Test Equipment

The following test equipment is required to calibrate the μ FLO^{G4} IMV:

- PCCU32, version 7.22 or later
- Deadweight tester or equivalent calibration standard
- Test gauge capable of dual range measurement (PSIG and inches)
- Barometer or another means which can determine barometric pressure
- Nitrogen or compressed air source

FYI



If a method other than the Compressed Nitrogen/Deadweight Tester method is used to calibrate the static pressure, the user must ensure that the prescribed flange tap valves are blocked to prevent false differential pressure from being applied to the DP cell. Also, ensure that both the high and low sides are pressured and equalized during SP calibration.

4.14.2 Hold Mode

When calibrating the IMV or setting up a fixed temperature, PCCU32 will instruct the μ FLO^{G4} to ignore live values for the flow calculation for the period of time the μ FLO^{G4} is being calibrated. This prevents real-time μ FLO^{G4} flow calculations from being affected during the calibration. During this time, the μ FLO^{G4} uses SP, DP and temperature that were all captured at the time calibration mode was entered. This is referred to as Hold mode.

To exit Hold mode:

- 1) Exit Calibration mode.
- 2) Unplug the PCCU cable at the μ FLO^{G4} connector.

TIP



ABB Totalflow recommends performing a five-point check before and after calibration. During normal operation. Either cell could be knocked out of calibration (typically due to a slug of liquid). WinCCU, the host software, is capable of recalculating the volume based on the differences between the previous five-point check and the current five-point check.

After a secure audit trail is archived, WinCCU recalculates the flow volume based on the previous and current markers. This allows more accurate results of the flow volume.

4.14.3 Static Pressure (SP) Calibration Checks

The μ FLO^{G4} allows the user to check the static pressure calibration and log the pressure market check points. The user should perform this check prior to and directly following the calibration.

During normal operation of the μ FLO^{G4}, the display provides continuous SP readouts. However, during this procedure, the μ FLO^{G4} is placed in a temporary Hold mode.

A minimum of three (3) SP markers should be set; however, the user can enter as many SP pressure markers as they prefer. Recording too many markers could cause the μ FLO^{G4} to overwrite existing, older events. Only the last five checks are used by the WINCCU editor for calibration adjustment. Enter a low, mid-low, mid, mid-high and high value.

ABB Totalflow recommends that the user follow their company's procedures as well as referring to API 21.1 for additional guidance.

FYI



During this procedure, the user will pressure both sides of the cell by closing both the high and low side orifice valves, opening the vent to atmosphere, closing the atmosphere vent and then opening both the high and low bypass valves.

CAUTION



The resulting comparison pressure must not be greater than the static pressure cell's maximum pressure.

4.14.3.1 Step-by-Step Instructions

- 1) The user will first need to enter the Calibration window by clicking the Calibrate icon in PCCU32. Once this has been accomplished, click the Checks tab. This will place the μ FLO^{G4} into Hold mode.
- 2) Select the preferred measurement tube from the tree-view.
- 3) Select SP from the Calibration drop-down menu.
- 4) Select the SP type: Absolute or Gauge (see Figure 4-10).

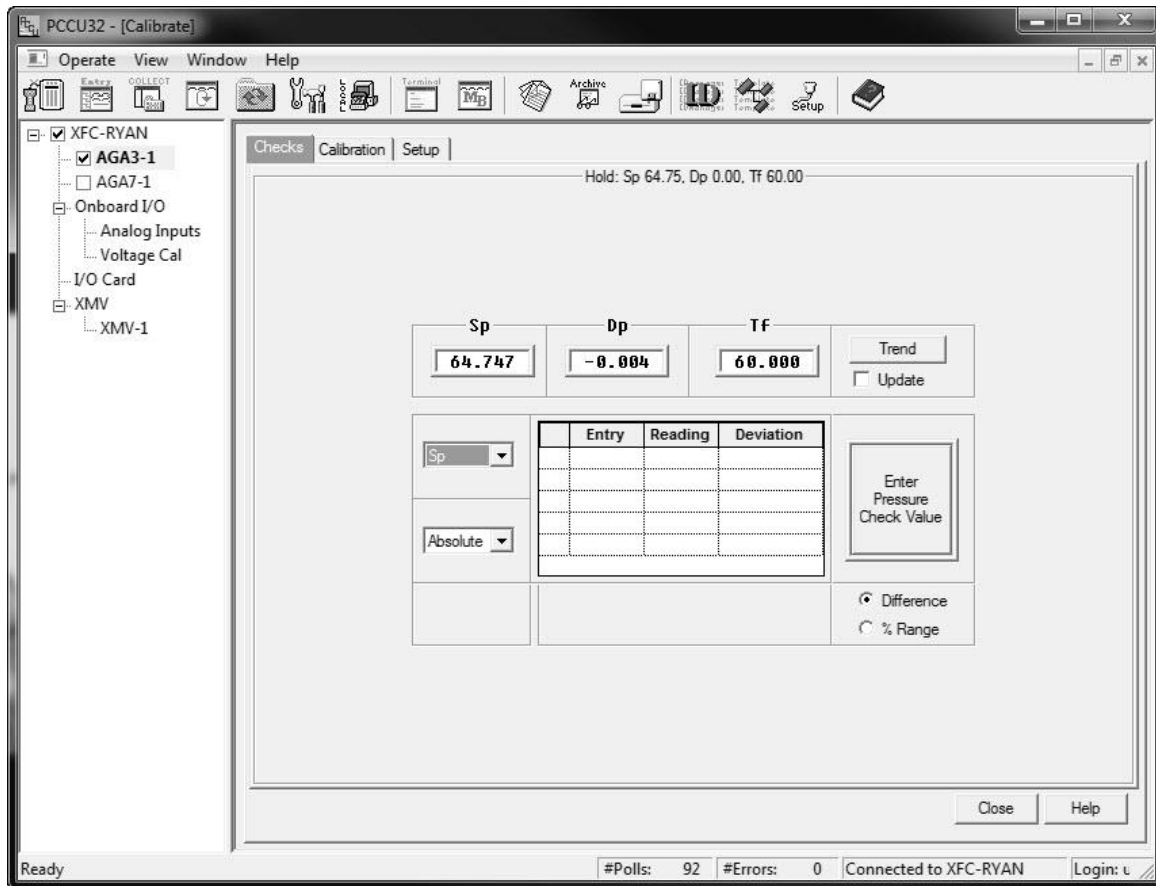

Figure 4-10 Calibration Screen - SP



TIP

Absolute will display values with barometric pressure added in. Additionally, the entered values will need the barometric pressure added in. Gauge will display values in gauge pressure. Additionally, entered values will need to be in gauge pressure.

- 5) Click on the Enter Pressure Check Value button. When the Enter Pressure dialog box displays, select the Continuous checkbox to update the current reading.
- 6) Verify that the vent valve is closed.
- 7) Open both the high and low equalizer valves.
- 8) Close both the downstream and upstream tap valves.
- 9) Open the atmospheric vent valve.
- 10) Enter a pressure marker for atmospheric pressure (psia). Enter zero if the user is in Gauge mode or the barometric pressure (or contract value) if in Absolute mode. Click the OK button.
- 11) Close the atmospheric vent valve.
- 12) Click on the Enter Pressure Check Value button.
- 13) Connect the calibration standard to the calibration test port.
- 14) Pressure to the next preferred verification pressure.

- 15) When the current reading stabilizes, enter the pressure value from the calibration source. Remember to add the barometric pressure if the pressure type is Absolute. Click the OK button.
- 16) Repeat steps 12 through 15 for each pressure check value.
- 17) When all the static pressure markers have been set, determine if calibration is required. If calibration is not required, return the manifold to service before exiting Calibration mode.

FYI



For additional information regarding static pressure calibration checks, see the PCCU32 help files.

4.14.4 Differential Pressure (DP) Calibration Checks

As discussed in the previous section, it is recommended that checks of the differential pressure (DP) be performed prior to and directly following calibration.

A minimum of three (3) differential pressure markers should be set; however, the user may enter as many DP pressure markers as they prefer. Recording too many markers may cause the $\mu\text{FLO}^{\text{G4}}$ to overwrite existing, older events. Only the last five checks are used by the WinCCU editor for calibration adjustment. Enter a low, mid-low, mid, mid-high and high value.

ABB Totalflow recommends that the user follow their company's procedures as well as referring to API 21.1 for additional guidance.

During normal operation of the $\mu\text{FLO}^{\text{G4}}$, the display provides continuous DP readouts. However, during this procedure, the $\mu\text{FLO}^{\text{G4}}$ is placed in a temporary Hold mode.

FYI



During this procedure, the user will pressure the high side of the cell by closing both the high and low side orifice valves, opening the vent to atmosphere and the low side bypass valve and closing the high side bypass valve.

4.14.4.1 Step-by-Step Instructions

- 1) The user will first need to enter the Calibration window by clicking the Calibrate icon in PCCU32. Once this has been accomplished, click the Checks tab. This will place the $\mu\text{FLO}^{\text{G4}}$ into Hold mode.
- 2) Select the preferred measurement tube from the tree-view.
- 3) Select DP from the Calibration drop-down menu (see Figure 4-11).

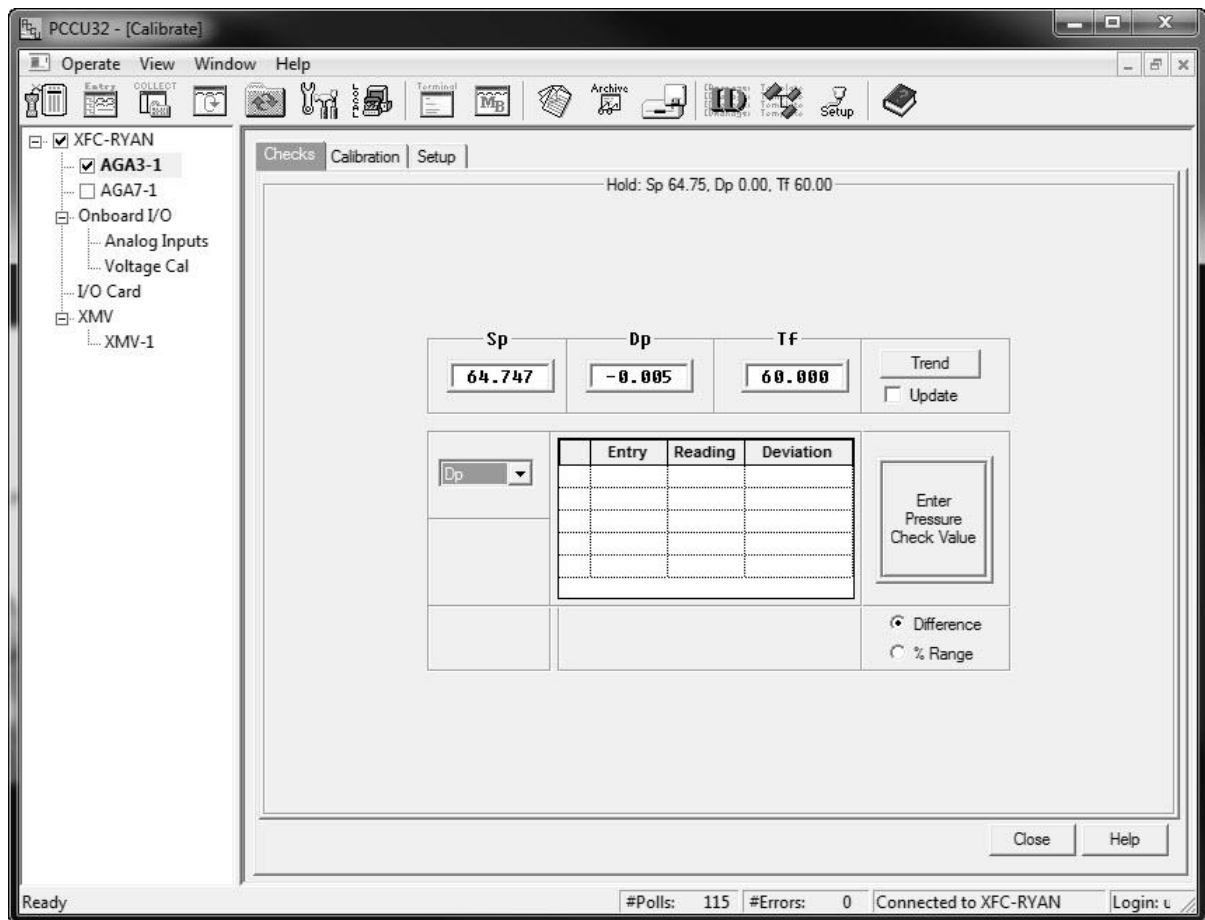

Figure 4-11 Calibration Screen - DP

- 4) Click on the Enter Pressure Check Value button. When the Enter Pressure dialog box displays, select the Continuous checkbox to update the current reading.
- 5) Verify that the vent valve is closed.
- 6) Open both the high and low equalizer valves.
- 7) Close both the downstream and upstream tap valves.
- 8) Open the atmospheric vent valve.
- 9) Enter a pressure marker for differential pressure, "0.0". Upon completion, click the OK button.
- 10) Close the high side equalizer valve.
- 11) Connect the calibration standard to the calibration test port.
- 12) Pressure to the next preferred verification pressure.
- 13) When the current reading stabilizes, enter the pressure value from the calibration source. Click the OK button.
- 14) When all of the differential pressure markers have been set, determine if calibration is required. If calibration is not required, return the manifold to service before exiting Calibration mode.

FYI



For additional information regarding differential pressure calibration checks, see the PCCU32 help files.

4.14.5 Calibrating Static Pressure

A three or five point pressure method is used to calibrate the $\mu\text{FLO}^{\text{G4}}$ static pressure cell. These different pressures are applied to the cell from a known, traceable source with resultant pressure values entered into the $\mu\text{FLO}^{\text{G4}}$ using PCCU32 software.

When performing the following procedures, wait for the $\mu\text{FLO}^{\text{G4}}$ display to stabilize. If the $\mu\text{FLO}^{\text{G4}}$ is not in Calibration mode, the display will not necessarily match applied cell pressures.

The $\mu\text{FLO}^{\text{G4}}$ uses an absolute static pressure (SP) call. Absolute pressure measures the referenced pressure to a vacuum or sealed pressure. This differs from a gauge cell which measures the referenced pressure to the atmosphere.

FYI



Since the static pressure cell is an absolute device, it always measures the true pressure relative to a vacuum or sealed chamber. As such, when vented, it measures the true barometric pressure.

For other points of calibration, add the reading of the PSI and the barometric pressure to arrive at the psia. Once this has happened, enter the reading.

4.14.5.1 Absolute vs. Gauge

It is recommended that the initial calibration point be at vented conditions. Additionally, when this takes place, ensure that the barometric pressure reading (in PSI) be used as the initial point.

When operating in PCCU32's Absolute mode, other points of calibration are arrived at by adding the PSI reading and the barometric pressure to arrive at the psia. Once this has happened, the user can enter this reading.

When operating in PCCU32's Gauge mode, the readings may be entered as read. Upon completion, a barometric pressure reading is entered.

4.14.5.2 Calculating PSI

To convert barometric pressure, measured from inches of mercury to barometric pressure (psi), perform the following calculation:

Barometric pressure (in inches of mercury) x .4912 or (÷ 2.036) equals barometric pressure in psi.

4.14.5.3 Step-by-Step Instructions

- 1) The user will first need to enter the Calibration window by clicking the Calibrate icon in PCCU32. Once this has been accomplished, click the Calibration tab. This will place the $\mu\text{FLO}^{\text{G4}}$ into Hold mode.
- 2) Select the preferred measurement tube from the tree-view.
- 3) Select SP from the Calibration drop-down menu.
- 4) Next, select either the 3- or 5-point calibration from the corresponding drop-down menu.

- 5) Set the Transducer SP Pressure Range in the Calibration window. This should match the range reading from the tag or label attached to the transducer.
- 6) Select the SP type: Absolute or Gauge.

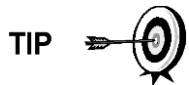

Absolute will display values with barometric pressure added in. Additionally, the entered values will need the barometric pressure added in. Gauge will display values in gauge pressure. Additionally, entered values will need to be in gauge pressure.

- 7) Enter the barometric pressure in the bottom window before proceeding.
- 8) Verify that the vent valve is closed.
- 9) Open both the high and low equalizer valves.
- 10) Close both the downstream and upstream tap valves.
- 11) Open the atmosphere vent valve.
- 12) Click on the Low Cal Point button. Verify the current reading is continuously updated. This should represent the lowest calibration point.
- 13) When the current reading stabilizes, click the OK button; otherwise, enter a different value, and then click the OK button.
- 14) When the previous reading was accepted, notice that the 100% Cal Point button is activated. To select, click the corresponding button.
- 15) Connect the calibration standard to the calibration test port.
- 16) Close the atmosphere vent valve.
- 17) Pressure to 100% of the transducer range (100% of the target value).
- 18) When the current reading stabilizes, accept the target value already showing in the window; otherwise, enter the pressure value from the calibration source. Click the OK button.
- 19) Again, notice that the next Cal Point is activated. To select, press Enter.
- 20) Pressure the transducer to the next target value as shown in the Calibration window.
- 21) When the current reading stabilizes, accept the target value already showing in the window; otherwise, enter the pressure value from the calibration source. Click the OK button.
- 22) Repeat steps 19 through 21 until all calibration points have been activated.
- 23) Upon completion of the SP calibration, new calibration markers should be set.
- 24) Return the manifold to service before exiting Calibration mode.

4.14.6 Calibrating Differential Pressure (DP)

A three or five point pressure method is used to calibrate the $\mu\text{FLO}^{\text{G4}}$ differential pressure cell. These different pressures are applied to the cell from a known, traceable source. The resultant pressure values are then entered in the $\mu\text{FLO}^{\text{G4}}$ using PCCU32 software.

During factory calibration, any differential pressure (DP) shift due to static pressure effect is corrected. This is not user-configurable and will not be modified due to field or user calibration. This ensures that the readings received in the field

are accurate. The user may not change the factory-set shift. If readings appear incorrect, the user may need to check for leaks and then recalibrate the DP.

When calibrating, wait for the readings to stabilize before entering the new values.

4.14.6.1 Step-by-Step Instructions

- 1) The user will first need to enter the Calibration window by clicking the Calibrate icon in PCCU32. Once this has been accomplished, click the Calibration tab. This will place the μ FLO^{G4} into Hold mode.
- 2) Select DP from the Calibration drop-down menu. Select 3 or 5 Point calibration.
- 3) Set the Transducer DP Pressure Range in the Calibration window before proceeding. This should match the range reading from the tag or label attached to the transducer. Target values based on the selected range will display in the Calibration table.
- 4) Verify that the vent valve is closed.
- 5) Open both the high and low equalizer valves.
- 6) Close both the downstream and upstream tap valves.
- 7) Open the atmospheric vent valve.
- 8) Click on the Low Cal Point button. Verify the current reading is continuously updated.
- 9) When the current reading stabilizes, click the OK button; otherwise, enter a different value. Click the OK button.
- 10) When the previous reading was accepted, notice that the 100% Cal Point button becomes activated. To select, press Enter.
- 11) Connect the calibration standard to the calibration test port.
- 12) Close the high side equalizer valve, and verify that the low side is vented to atmosphere.
- 13) Pressure to 100% of the transducer range (100% of target value).
- 14) When the current reading stabilizes, accept the target value already showing in the window; otherwise, enter the pressure value from the calibration source. Click the OK button.
- 15) Again, notice that the next Cal Point is activated. To select, press Enter.
- 16) Pressure the transducer to the next target value as shown in the Calibration window.
- 17) When the current reading stabilizes, accept the target value already showing in the window; otherwise, enter the pressure value from the calibration source. Click the OK button.
- 18) Repeat steps 15 through 17 until all calibration ports have been entered.
- 19) Upon completion of the DP calibration, new calibration markers should be set.
- 20) Return the manifold to service before exiting Calibration mode.

4.14.7 Optional I/O Card Calibration

The Calibration mode enables the calibration of the analog inputs and pulse inputs as they exist on the optional I/O card.

4.14.7.1 Hold Mode

When calibrating, PCCU32 will instruct the $\mu\text{FLO}^{\text{G4}}$ to ignore live values for the period of that the $\mu\text{FLO}^{\text{G4}}$ is being calibrated. This prevents real-time $\mu\text{FLO}^{\text{G4}}$ calculations from being affected during calibration. During this time, the $\mu\text{FLO}^{\text{G4}}$ uses the last known value at the time Calibration mode was entered. This is referred to as Hold mode.

To exit Hold mode:

- 1) Exit Calibration mode.
- 2) Unplug the PCCU cable at the $\mu\text{FLO}^{\text{G4}}$ connector.

4.14.7.2 Calibrating the Analog Inputs

The optional I/O card comes standard with two (2) analog inputs. As the user enters Calibration mode, the $\mu\text{FLO}^{\text{G4}}$ will move into Hold and display the current values.

When the user selects the Update checkbox, the Current Values section displays the current values continuously. When different analog inputs are selected, their assigned register numbers are displayed on the top of the screen.

Follow the instructions in the PCCU32 help files for specific software steps. Generally, the user will need to perform the following procedures:

TIP  If the user intends to use a 4-20 mA transmitter on the analog input, please refer to the appendices. The manufacturer's specifications can often lead to confusion. In some instances, the manufacturer's specifications will claim to operate from 10 to 30 Vdc. They are not always clear that this 10-30 Vdc must be applied across the 4-20 mA transmitter only (and not across the transmitter/load resistor series combination). Again, refer to the appendices.

- 1) Connect an accurate power source capable of 1-5 Volts to the AI terminals that are to be calibrated.
- 2) In the Calibration window for the AI being calibrated, select either 3 or 5 point calibration for the number of preferred calibration points. 3-point for low (50% or 100% values) or 5-point for high (25%, 50%, 75% and 100% values).
- 3) Within the Current Value section, select the Update checkbox. This causes the AI to look for the source at the terminals instead of a test value.
- 4) Begin the calibration process by starting at the first selection, Low Cal Point. Apply one Volt to the AI terminals.
- 5) Click the Low Cal Point button. A dialog box displays. In the Current Reading parameter field, enter a value (typically zero) representing both the low calibration point and the engineering units.
- 6) Upon completion, click the OK button.

TIP  The current reading value on the pop-up entry screens will be placed in the Reading column and represents values from the previous calibration. User-entered values will be displayed in the Entry column.

- 7) The user will now need to click the 100% Cal Point button. When the dialog box displays, apply five Volts to the AI terminals.

- 8) In the Current Reading parameter field, the user will need to enter a value that represents both the full range and the preferred engineering units.
- 9) Upon completion, click the OK button.
- 10) If a 3-point calibration was selected, click the 50% Cal Point button. When the dialog box displays, apply three Volts to the to the AI terminals.
- 11) In the Current Reading parameter field, the user will need to enter a value that represents both the 50% range and the preferred engineering units.

FYI



If performing a 5-point calibration, the user will need to add additional values for both 25% and 75% calculation points.

4.14.7.3 Pulse and Digital Inputs

The μ FLO^{G4} base unit has one (1) DI/PI standard and (1) one high-speed pulse input. This can also be used as a digital input. The following procedure will enable the user to set the digital input.

Follow the instructions in the PCCU32 help files for specific hardware steps.

- 1) The user will need to click on the Calibrate icon on the PCCU32 main toolbar. Upon completion, click on the AGA-7 tube in the tree-view.
- 2) Click on the Setup tab.
- 3) If the device was ordered as a pulse input meter, the register addresses (static pressure, pulse input and temperature) are listed and fixed. If, however, a new tube application was added by the user, they will need to manually enter the register addresses.
- 4) Next, the user will need to click on the K-Factor button. Enter a value, and click the OK button. Input pulses are multiplied by the K-Factor. To have a one-to-one pulse count, user a factor of 1.

CAUTION



Take into consideration that these inputs may have de-bounce either enabled or disabled. This feature is discussed in the PCCU32 help files and is also turned on or off within PCCU32.

4.15 Zero Transducer

During the process of setting pressure markers to determine the needs for a calibration of either the static pressure (SP) or the differential pressure (DP), the user may conclude that the SP or DP pressures are out of alignment at exactly the same amount at each pressure marker (linear shift). When this occurs, the user may either recalibrate the μ FLO^{G4} or they can set the transducer to zero. The preferred method is to recalibrate the μ FLO^{G4}. This maintains the μ FLO^{G4} records in a manner that assures accountability and continuity when other measurement issues arise. By using the Zero Transducer command, all references to previous pressure markers are non-existent, eliminating the ability to adjust volumes based on previous markers.

CAUTION



Using the Zero Transducer capability assumes that the shift is linear. This means that at different levels of pressure the transducer is off by exactly the same amount. If this is not the case, the user needs to recalibrate the transducer instead.

4.15.1 Static Pressure

The SP can be zeroed without recalibrating. If the SP shifts, the user can enter a new barometric pressure value. This shifts the SP transducer curve. After the Hold state initiates, select Zero Transducer.

4.15.2 Differential Pressure

The DP can be zeroed without recalibrating. If the DP shifts, the user can enter a new zero (0). This shifts the DP curve. After the Hold state initiates, select Zero Transducer.

4.16 RTD Calibration and Bias

The μ FLO^{G4} has one onboard RTD input. The registers that represent the RTD input is normally assigned to a measurement tube. To calibrate the RTD, the user will need to select the appropriate tube from the Calibrate tree-view. Upon completion, move to the Calibration tab, and select Tf from the drop-down menu (see Figure 4-12).

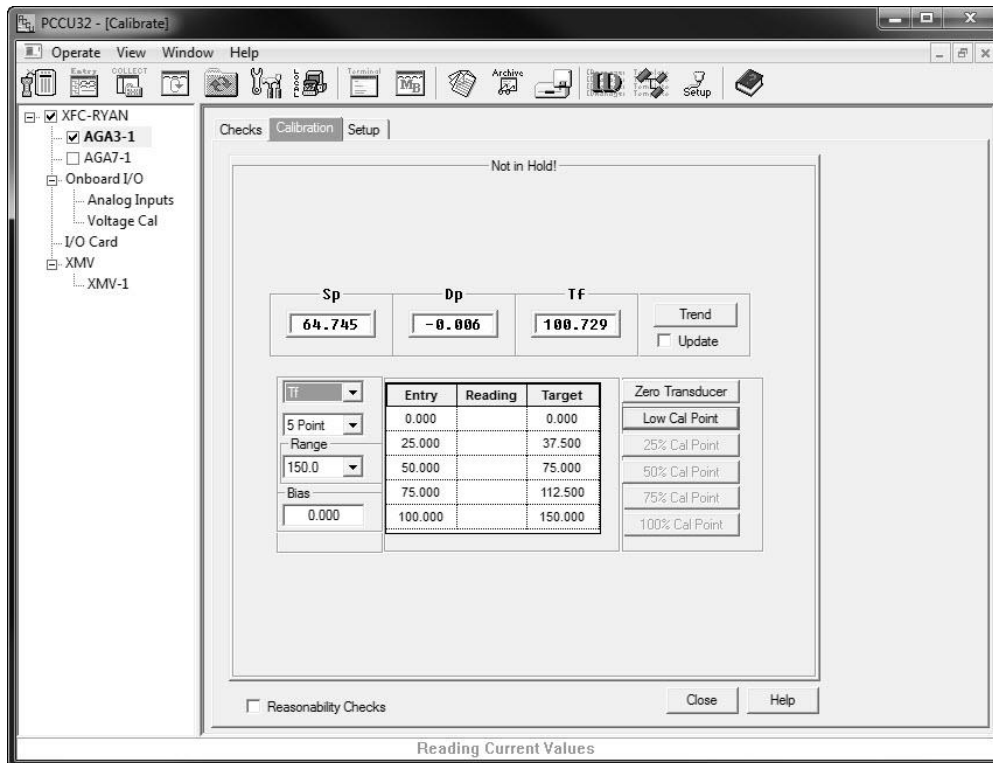

Figure 4-12 RTD Calibration Screen

The user can view the current value of the selected RTD by selecting the Update checkbox.

4.16.1 Step-by-Step Instructions

- 1) Connect the variable resistor or RTD calibration equipment to J1 on the μ FLO^{G4} board.

Terminal	J1
1	SHLD
2	Out
3	Plus (+)
4	Minus (-)
5	In

FYI



If the user elects to calibrate using an 100 Ω RTD probe, refer to the PCCU32 help files to view resistance and corresponding temperature readings.

- 2) From the Calibrate tree-view, select the tube that the user prefers to calibrate.
- 3) Upon selection, click the Calibration tab. Once the user is in the tab, select Tf from the corresponding drop-down menu.
- 4) Select whether to perform a 3-point, 5-point or Bias calibration. Note that if a 3-point is selected, there will be three Target values and three Cal Point buttons. If 5-point is selected, there will be five Target values and five Cal Point buttons.
- 5) Click inside the Range parameter field, and enter a range. The range can be anything and represent any units (percents, volts, etc.) that the user prefers. Target values will be updated to reflect the new calibration range.
- 6) Click on the Low Cal Point button, and apply the Voltage (typically 1 Volt) for the low calibration point. Verify the current reading on the Enter Low Calibration Value screen is stable.
- 7) Enter the Target value for the Low Cal Point. Click the OK button.
- 8) Click on the 100% Cal Point button, apply the Voltage (typically 5 Volts) that represents the full range and verify the current reading is stable.
- 9) Enter the Target value for the 100% Cal Point. Upon completion, click the OK button.
- 10) Click on the next highest Cal Point button, and apply a voltage that represents its range. Verify the current reading is stable.
- 11) Enter the Target value for that Cal Point. Upon completion, click the OK button.
- 12) Repeat steps 9 through 10 for any remaining Cal Points. After the last point is entered, PCCU32 will automatically calibrate the AI.

4.16.2 Calibrating RTD Temperature Bias

If the user elects to use Bias as a calibration method, select Bias from the Calibration drop-down menu.

To change, click in the Bias parameter field. The RTD Bias dialog box will display. This allows the user to enter a new value. The RTD's temperature will always be biased by this value; however, the RTD Installed box on the Setup tab must be checked for the RTD temperature and bias to be used. If the bias needs to be negative, the user will need to enter a minus sign (-) before the value. The current

temperature value under the Tf heading will increase or decrease to reflect the effect of the bias. The bias does not affect the Fixed Temperature that is specified on the Setup tab. The user can select Sp, Dp, etc., in the drop-down Calibration menu to return to the selected Calibration screen.

4.17 Changing the Orifice Plate

Use one of the following procedures when changing the orifice plate:

4.17.1 Taking the Meter Run Out of Service (Simplex Fitting)

- 1) Take the meter run out of service.
- 2) Replace the physical orifice plate.
- 3) If the user prefers to end the current log record and begin a new record with the new orifice size (as stated in API 21.1), they need to first move into Entry mode within PCCU32. Next, select the preferred measurement tube, and then click on the Commands tab. Change the value for the Reset Log Period to Yes. This forces a new record to be written, based on the old orifice plate size. Additionally, if the user wants to simultaneously zero the accumulated volume, they can use the Reset Volume command instead.

It is recommended to perform either the Reset Log Period or the Reset Volume command to enhance the audit trail created by the event (API 21.1 requirement).

- 4) In PCCU32, enter the new orifice plate diameter.
- 5) Return the meter to service.

4.17.2 Leaving Meter Run In Service Procedure (Senior Fitting)

- 1) Place the $\mu\text{FLO}^{\text{G4}}$ in Hold by entering into Calibration mode. This enables the constant SP, DP and temperature values to be used while the orifice plate is being changed.
- 2) Replace the orifice plate.
- 3) Exit Calibration mode. This releases Hold of the SP, DP and temperature.
- 4) If the user prefers to end the current log record and begin a new record with the new orifice size (as stated in API 21.1), they need to first move into Entry mode within PCCU32. Next, select the preferred measurement tube, and then click on the Commands tab. Change the value for the Reset Log Period to Yes. This forces a new record to be written based on the old orifice plate size. Additionally, if the user wants to simultaneously zero the accumulated volume, they can use the Reset Volume command instead.

It is recommended to perform either the Reset Log Period or the Reset Volume command to enhance the audit trail created by the event (API 21.1 requirement).

- 5) In PCCU32, enter the new orifice plate diameter.

FYI



At the top of the Volume Calculation Period, the $\mu\text{FLO}^{\text{G4}}$ will perform calculations based on the new orifice plate diameter for part of the period after the log was reset.

5.0 TROUBLESHOOTING

5.1 Overview

To serve as an aid in troubleshooting the μ FLO^{G4}, the following chapter will provide guidelines for the various subsystems within the device.

The chapter contains a troubleshooting flowchart (see Figure 5-1). As the user follows the logic in this flowchart, they will be directed to specific test instructions that are found in this chapter or may be directed to the Power Troubleshooting section or the Communication Troubleshooting section. In addition to the flowchart, this chapter contains step-by-step procedures for troubleshooting the μ FLO^{G4} with or without an installed radio communication unit.

5.1.1 Troubleshooting Support

If troubleshooting instructions do not lead to a resolution and assistance is required, the user can contact the Totalflow Service department:

USA: (800) 442-3097

International: 001-918-338-4880

5.1.2 Visual Alarm Codes

As noted in Chapter 1, the unit's LCD annunciator (see Figure 1-1) displays many different status indicators that are related to the μ FLO^{G4}'s operation. This section contains information on those codes that reflect errors or provide information that is useful in troubleshooting the device. Alarm codes indicate that an operational problem exists.

The user is informed of operational problems and operational limit violations by observing the alarm codes on the right side of the LCD display.

5.1.3 Sleep Mode

Totalflow units are designed to move into a low power mode, Sleep, when an insufficient supply voltage is present for a period of time. The issue that needs to be addressed is the reason for the Sleep alarm; waking up the unit will be insufficient for correcting the problem. As such, issues relating to the system's power supply should be investigated. This mode is designed for a nominal 12 Vdc system with battery backup.

5.1.4 Solar Panel

When a solar panel is attached to the unit as a means of providing a charging source for the battery, cleanliness and positioning play an important part as do proper electrical and cabling techniques. More detailed information on power consumption can be found at www.abb.com/totalflow.

5.1.5 Communication

Troubleshooting the communications for this unit requires that both pieces of equipment be tested: the μ FLO^{G4} com ports and the communication device. This is discussed in more detail in the Communications Overview section. Other communication troubleshooting information is shared in the following categories: RS-232, RS-485, and RS-422 Communications.

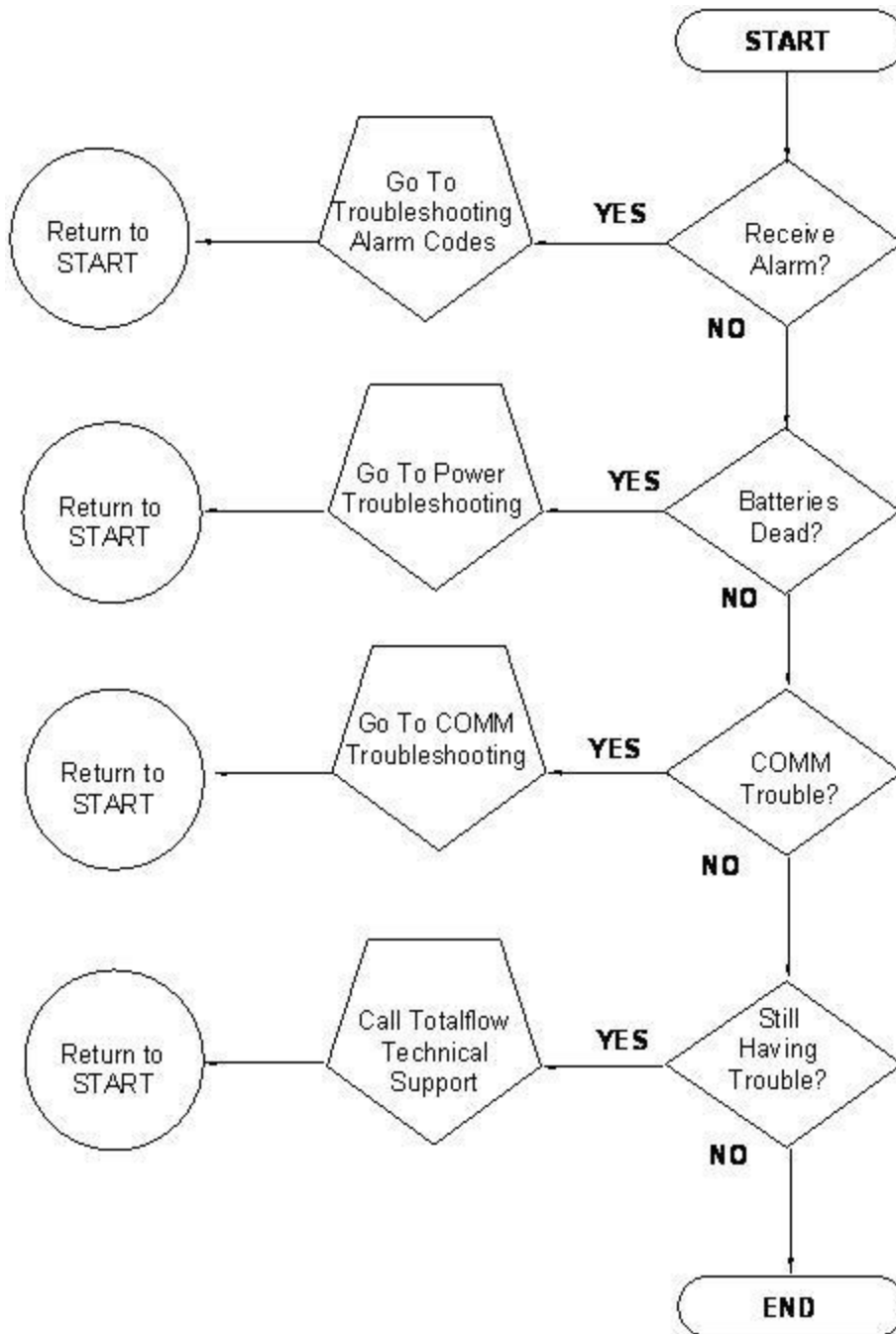

Figure 5-1 Troubleshooting Flowchart

5.2 Troubleshooting Visual Alarm Codes

When a visual indicator is present (see Figure 5-2), the following section will assist in determining the probable cause and the steps required to correct the condition.

For the purposes of troubleshooting, only those codes considered alarms or codes used to assist troubleshooting are discussed here. The entire list of status and alarm codes can be found in Chapter 1 (see Table 1-2). The following table

contains a description of each μ FLO^{G4} alarm code. An alarm can be a word, character, letter or symbol.

An application can be assigned to an annunciator, and any alarms or status codes associated with that application will be displayed.

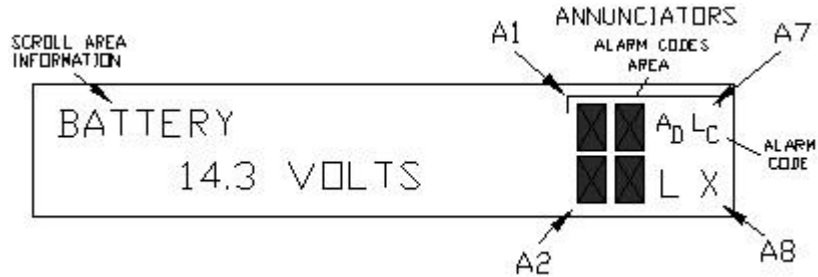

Figure 5-2 Liquid Crystal Display and Indicators

Table 5-1 Visual Alarm Codes

Indicator	Description	Alarm
I/O Subsystem		
L _L	Low Lithium Alarm: When L _L (low lithium) is displayed, the lithium battery voltage is below 2.5 Vdc. If the battery voltage is above 2.5 Vdc, A1 appears shaded. A new lithium battery measures approximately 3.6 Vdc.	Y
L _C	Low Charger: Displayed if the μ FLO ^{G4} battery charging voltage is less than (+) 0.4 Vdc higher than the battery voltage. If the charging voltage is (+) 0.4 Vdc greater than the battery voltage, the annunciator is shaded	Y
Measurement Application		
A _D	A to D Failure: Displayed if the A to D Converter absolute differential pressure, absolute static pressure or temperature readings exceed maximum counts or are less than the minimum counts. If the A to D Converter readings are within range, the A _D is shaded.	Y
Communication Protocols		
→	Transmitting Data: Sending a response.	N
←	Receiving Data: Processing a request.	N
!	Nak: Negative acknowledgement with packet list.	N
+	Ack: Positive acknowledgement of receipt of request.	N
†	Waiting for Ack: Waiting for response after transmission.	N
?	Exception Alarm Processing	N
ƒ	ID Recognized: Recognized and receiving request.	N
‡	Listen Cycle: Flashes if this remote port is active and running Totalflow remote protocol. Flashes in synch with the listening cycle that occurs at 1, 2 or 4 second intervals.	N
M	MODBUS ASCII: MODBUS ASCII protocol selected for the port assigned to this annunciator.	N
m	MODBUS RTU: MODBUS RTU protocols is selected for the port assigned to this annunciator.	N

L	Local Protocol: Displayed when the PCCU port is active and running Totalflow local protocol.	N
¥	ID Recognized: The ID has been recognized but is waiting for Synch.	N

5.2.1 Troubleshooting a Blank LCD Screen

When the LCD is blank, it means that the unit has entered SLEEP mode. This generally indicates the battery voltage has dropped below 10.9 Vdc.

5.2.1.1 Step-by-Step Instructions

- 1) Make a local connection with the μ FLO^{G4}. This wakes up the unit so that the user may check all alarm conditions and determine the problem.
- 2) Check the battery pack cable. It must make a good, secure electrical connection with the μ FLO^{G4} board BATT connector, J15 (see Figure 5-3).

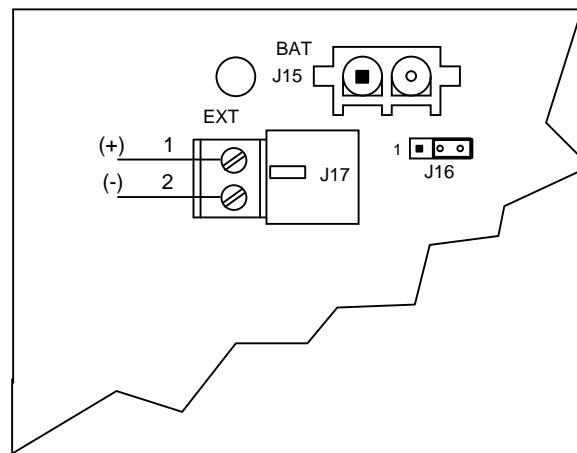

Figure 5-3 Battery Charger and Battery Pack Connections

- 3) Check the battery pack cable is securely connected.
- 4) Check the battery pack voltage. If the voltage is low, replace with another battery pack.
- 5) If the voltage is still low, investigate the power issues using the Power Troubleshooting flow chart.

5.2.2 Troubleshooting a Low Lithium Alarm (L_L)

When the Low Lithium alarm displays, the lithium battery should be replaced immediately. Failure to replace the lithium battery could result in a loss of data following a power loss. Instructions for replacing the lithium battery can be found in Chapter 4.

5.2.3 Troubleshooting a Low Charger Alarm (L_C)

The Low Charger alarm is typically displayed if the battery charging voltage is less than (+) 0.4 Vdc higher than the battery voltage. Another factor could be the existence of low light conditions when the system is charged using a solar power charger.

5.2.3.1 Step-by-Step Instructions

- 1) Check the battery pack cable. It must make a good, secure electrical connection with the μ FLOG⁴ board BATT connector, J15 (see Figure 5-3).
- 2) Check that the battery pack cable is securely connected.
- 3) Check the battery pack charging source in PCCU32. Open PCCU32, and move to the I/O Interface within the tree-view. Select the Auxiliary I/O sub-menu. Upon selection, this will take the user to the Analog tab. Within the tab, the user can view both the battery and charger voltage. If the charger voltage is less than +0.4 Vdc, proceed to the Power Troubleshooting section within this chapter.

5.2.4 Troubleshooting a Analog to Digital Failure Alarm (^A_D)

The μ FLOG⁴ must have a measurement tube application running to receive this error. If the A to D Failure alarm code is present or the device is in the SLEEP mode but is still receiving minimum voltage, it may be necessary to test the data link between the μ FLOG⁴ board and the transducer. Follow the instructions below to check the transducer.

Probable causes of receiving the A to D failure include:

- A/D converter is over or under range (DP, SP or Tf)
- Loose wiring connections
- Faulty RTD probe

If the A to D converter readings are within range, ^A_D is shaded.

5.2.4.1 Step-by-Step Instructions

- 1) Begin by collecting data from the unit.
- 2) View the event log in PCCU32 for codes (see PCCU help files for more information):
 - 99 A/D converter could not be read.
 - 100 A/D converter could be read again.
- 3) If the event code is found, follow the guidelines for returning the transducer to ABB Totalflow for repair or replacement. If the event code is not found, continue to the next step
- 4) Open PCCU32, and select the I/O Interface within the tree-view. The user needs to click on the Analog Inputs tab. Check the SP, DP and temperature to determine which measurement channel is causing the alarm.
 - If the alarm is caused by the SP or DP channel, equalize and vent the manifold.
 - If the alarm disappears: the SP or DP cell is not ranged properly or the manifold may have blockage.
 - If the alarm is still present, replace the transducer.
 - If the alarm is caused by the temperature channel, move to step 9; otherwise, move to the next step.
- 5) Set the IMV back to Factory calibration. If this corrects the alarm, recalibrate the IMV to correct the field calibration. If the alarm is not corrected, continue to the next step.
- 6) Perform a warm start on the unit. Verify that the unit is not displaying a low lithium (^L) alarm. Upon verification, remove power from the unit. Once

power is removed the user will need to return power to unit. If the A/D Failure alarm is not corrected, continue to the next step.

- 7) Perform a Save and Restore function. Follow the procedures in Chapter 4. Be sure to restore these files to the tfCold drive.
- 8) Perform a cold start on the unit. Follow the Reset procedures covered in this chapter. If the problem is not corrected, continue to the next step.
- 9) Check the RTD wiring at the IMV.
- 10) Perform the three procedures found within the following sections:
 - RTD Continuity Test
 - RTD Resistive Test
 - RTD Impedance Test
- 11) Contact ABB Totalflow to repair or replace the IMV.

5.2.5 Resistive Temperature Detector (RTD) Continuity Test

Should the readings from the RTD be suspect, follow the instructions below to test the RTD probe.

5.2.5.1 Required Equipment

- Digital MultiMeter (DMM) with alligator clip leads

5.2.5.2 Step-by-Step Instructions

- 1) Disconnect the power and communications from the IMV.
- 2) Disconnect the RTD from the IMV.
- 3) Perform the continuity test on the wires leading to the probe. Set the DMM to 200 Ω or Continuity Audio.
- 4) Check the continuity of the first wire pair (typically red or black) by connecting one lead to each wire. The meter should read zero or close to zero.
- 5) If there is continuity, move to step 7. If there is no continuity, verify that the wiring at the RTD head is correct.
- 6) If the wiring at the connection head is correct, the RTD is defective. Replace the probe; otherwise continue to the next step.
- 7) Check the continuity of the second wire pair (typically white) by connecting one lead to each wire. The meter should read zero or close to zero.
- 8) Check the continuity of each wire (first pair either red or black, as identified in step 4) to the probe or shield. If there is continuity, the RTD is defective. Replace the probe. If there is no continuity, continue to the next step.
- 9) Check the continuity of each second wire pair (white or as identified in step 7) to the probe or shield. If there is continuity, the RTD is defective. Replace the probe. If there is no continuity, continue to the next step.
- 10) Check the continuity of each first wire pair (as identified in step 4) to each second wire pair (as identified in step 7). The meter should read approximately 100 to 140 Ω . If this is the case, continue to the next step. If not, the RTD is defective and should be replaced.
- 11) If the probe is still not functioning correctly, recheck the wiring using the supplied diagram. If no wiring error was found, perform the RTD Current Source Troubleshooting test.

5.2.6 RTD Current Source (Resistive) Test

If the readings from the RTD are still suspect following the RTD Probe Continuity Test, follow the instructions below to test the current source on the $\mu\text{FLO}^{\text{G4}}$ board to verify it is receiving power.

5.2.6.1 Required Equipment

- Totalflow Diagnostic Kit
- Digital MultiMeter with alligator clip leads

5.2.6.2 Step-by-Step Instructions

- 1) Begin by disconnecting power and communications from the $\mu\text{FLO}^{\text{G4}}$ board, if not already done.
- 2) Disconnect the RTD from the $\mu\text{FLO}^{\text{G4}}$ board, if not already done.
- 3) Set the DMM to 200 Vdc.
- 4) Select the RTD test resistance value by selecting the resistor test connector from the Totalflow diagnostic kit. The user can also create one by using a resistor appropriate for their unit.
 - Substitute the RTD probe wiring by connecting either a 100 Ω or 123 Ω resistor across connector terminals 4 and 5.
 - Connect a jumper wire between terminals 2 and 5.
 - Connect a jumper wire between terminals 3 and 4.
- 5) Clip the positive lead of the DMM to the upper side of the RTD test resistor.
- 6) Clip the negative lead of the DMM to the lower side of the RTD test resistor.
- 7) Supply power to the unit.
- 8) Once running, the measured value across the RTD test resistor should be either:
 - 100 Ω Resistor – Minimum of 100 MV to a maximum of 125 MV.
 - 123 Ω Resistor – Minimum of 123 MV to a maximum of 155 MV.
- 9) The RTD measurement temperature on the $\mu\text{FLO}^{\text{G4}}$'s display should read either:
 - 100 Ω Resistor – 31.0°F to 33.0°F
 - 123 Ω Resistor – 140.8°F to 142.8°F
- 10) If either of the measured values are outside of range, remove power. The user will then need to replace the RTD.
- 11) Return power and perform steps 9 and 10 again. If either of the measured values are outside of range, remove power. The user will then need to replace the $\mu\text{FLO}^{\text{G4}}$ board.
- 12) Return power and perform steps 9 and 10. If either of the measured values are outside of the range, remove power. The user will then need to replace the IMV.

5.2.7 RTD Impedance Test

If readings from the RTD are still suspect following the RTD Probe Test, follow the instructions below to test the current source on the $\mu\text{FLO}^{\text{G4}}$ board to verify it is receiving power.

5.2.7.1 Required Equipment

- Ice Bath
- Digital MultiMeter

5.2.7.2 Step-by-Step Instructions

- 1) Immerse the RTD probe in the ice bath.
- 2) Perform a continuity check between any two similarly colored wires. Measured resistance should be 1 Ω or less.
- 3) Perform a continuity check between any two dissimilar colored wires. Measured resistance should be approximately 100 Ω .
- 4) Perform a continuity check between the shield wire and any other wires. Measured resistance should be in the M Ω range.
- 5) If any values are returned out of range, the RTD probe is defective. Replace the RTD.

5.3 Power Troubleshooting

This section focuses on determining what has caused the μ FLO^{G4} to lose power. Generally, loss of power can be attributed to only the power supply system. However, if the power supply system is used for powering a transceiver or other peripheral equipment, an issue with that equipment may drain the battery and cause the μ FLO^{G4} to lose power. The user should notice that the Power Troubleshooting Flowchart (see Figure 5-4) takes them through several tests but may also direct them to the Communication Troubleshooting Flowchart located later in this chapter.

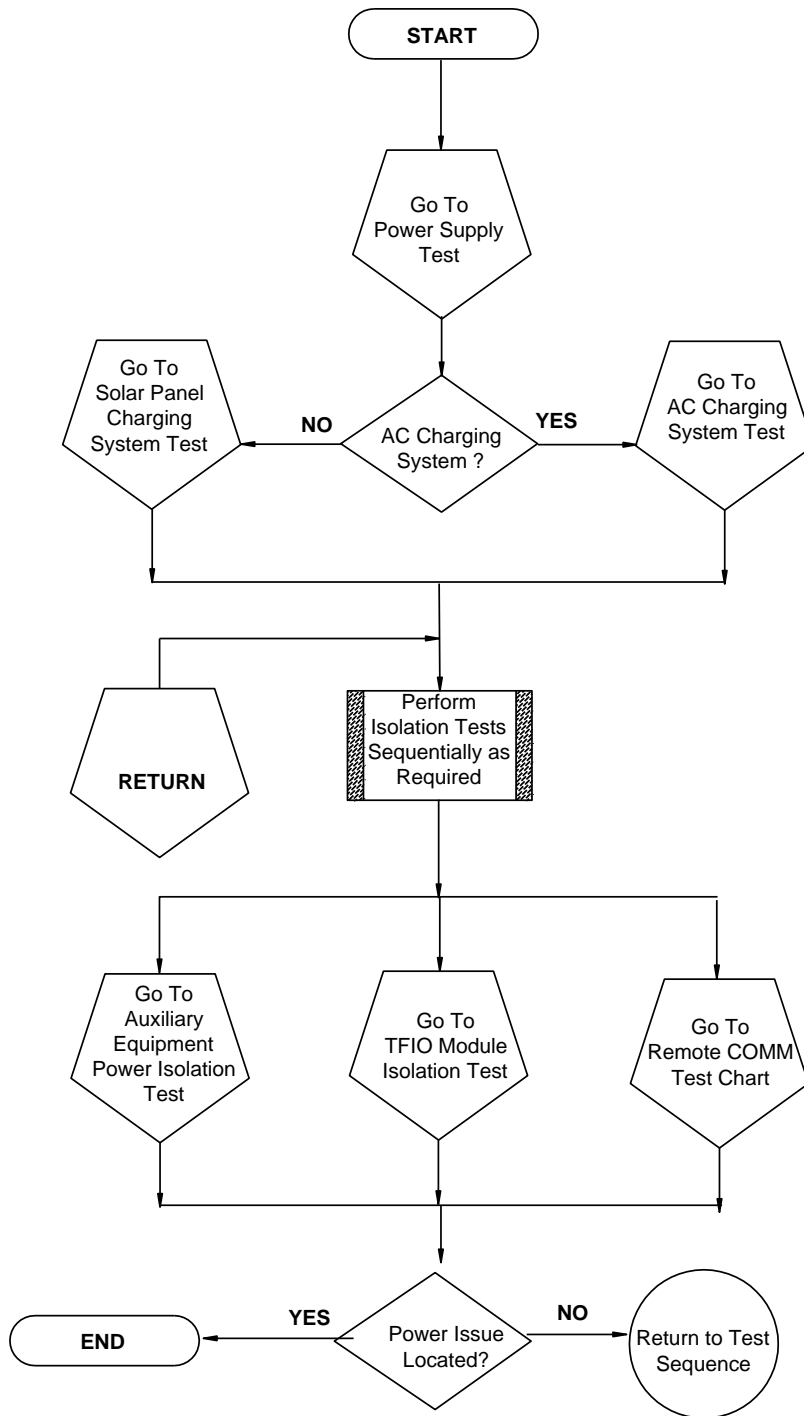

Figure 5-4 Power Troubleshooting Flowchart

5.3.1 Power Supply Test

Various equipment configurations will necessitate moving to one or more additional tests from this location.

5.3.1.1 Step-by-Step Instructions

- 1) Check that the power supply voltage setting, the power supply current rating and the cables used for the installation meet the recommended requirements.
- 2) If this is a new installation and external equipment is being powered from the μ FLO^{G4}, call ABB Totalflow Technical Support for help in evaluating the cable and power supply installation requirements.
- 3) Correct and retest, as necessary.
- 4) Check for a poor cable connection in the cable between the μ FLO^{G4} and the J15 battery pack and the J17 charging source (see Figure 5-5). Verify all field wiring screw terminals are tight.
- 5) Correct and retest, as necessary.
- 6) Verify that there are no other devices that may drop an excessive voltage across them in the power supply circuit (to the μ FLO^{G4}).
- 7) Correct and retest, as necessary.
- 8) Disconnect the charging source cable at the μ FLO^{G4} board's J17 connector.
- 9) Replace the battery with a known, good battery. Use the Battery Pack Replacement procedure located in chapter 4.
- 10) Reconnect the charging source cable to the μ FLO^{G4} board's J17 connector.
- 11) Measure the voltage at the charging source cable. Measure the voltage at the battery pack. Compare the voltages. If the charging source voltage is less than (+) 0.4 Vdc higher than the battery voltage, return to Figure 5-4 and continue.

5.3.2 Solar Panel Charging System Test

If the system setup includes a solar panel charger connected to the μ FLO^{G4} board and it is not supplying the required voltage to the μ FLO^{G4} unit, the user may need to test the solar panel.

5.3.2.1 Step-by-Step Instructions

- 1) Check the solar panel angle and direction. In the northern hemisphere, the panel should face due south. In the southern hemisphere, the panel should face due north.
- 2) Correct and retest, as necessary.
- 3) Check the solar panel for any physical damage or obstructions to sunlight. Sunlight obstruction prevents the solar panel from receiving enough sunlight to charge the installed battery pack.
- 4) Correct and retest, as necessary.
- 5) The solar panel should be positioned so it receives the most sunlight. Do not place it in a shaded area.
- 6) Correct and retest, as necessary.
- 7) Check the solar panel wiring to be certain it is correctly connected to the associated J17 charger input termination block (see Figure 5-5).
- 8) Correct and retest, as necessary.

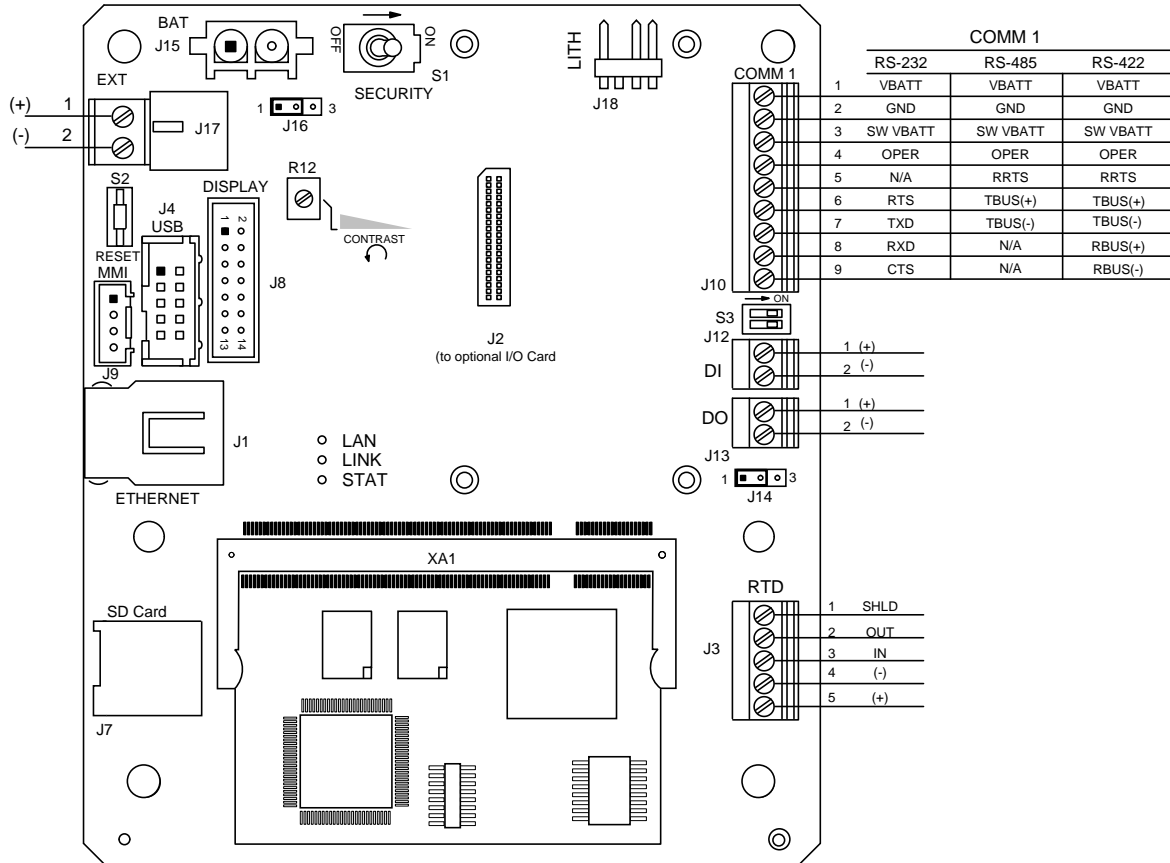

Figure 5-5 μ FLO^{G4} Board

- 9) Measure the solar panel voltage at the connector using a DMM that connects the (+) and (-) leads to the (+) and (-) solar panel wires. The loaded voltage should be greater than or equal to the specifications listed in Table 5-2. If the solar panel is not above the minimum, replace the solar panel and retest.
- 10) Disconnect the solar panel from the μ FLO^{G4} board.
- 11) Set the DMM range to read over 20 Vdc.
- 12) Determine if the open circuit voltage is greater than or equal to the specifications listed in Table 5-2 by clipping the positive lead of the DMM to the positive wire and clipping the negative lead of the DMM to the negative wire. If the solar panel is not above the minimum, continue to the next step.
- 13) Using the selected resistor from Table 5-2 for the solar panel wattage, attach the selected resistor between the two solar panel wires.
- 14) Clip the positive lead of the DMM to the one side of the test resistor.
- 15) Clip the negative lead of the DMM to the other side of the test resistor.
- 16) Determine if the loaded voltage is greater than or equal to the specifications listed in Table 5-2. If the solar panel is not above the minimum, replace the solar panel and retest.
- 17) If an issue still exists, return to the Power Troubleshooting Flowchart.

Table 5-2 Specifications for Solar Panels

Panel	Max	Volts @P _{MAX}	Open Circuit	Load Resistance	Loaded Voltage
10	10W	16.8V	21V	30 Ω 25W	16-18 Vdc
20	20W	16.8V	21V	15 Ω 25W	16-18 Vdc
30	30W	16.8V	21V	10 Ω 40W	16-18 Vdc

5.3.3 AC Charging System

If the system setup includes an AC charger connected to the μ FLO^{G4} board and it is not supplying the required voltage to the unit, the user may need to test the AC charger.

5.3.3.1 Step-by-Step Instructions

- 1) Check the DC wiring to J17 charger input termination block connector. Be certain the wiring is correct.
- 2) Correct and retest, as necessary.
- 3) Check the input AC power supply voltage to the external AC charging unit. Be certain the primary AC voltage is correct.
- 4) Correct and retest, as necessary.
- 5) If the primary AC voltage input level is correct, wiring to the μ FLO^{G4} board terminal is correct and there is no DC output from the charger. Replace the charger fuse.
- 6) Correct and retest, as necessary.
- 7) If the fuse is not faulty or there is no charger DC output voltage after replacing the fuse, replace the AC charging unit.
- 8) Correct and retest, as necessary.
- 9) If an issue still exists, return to the Power Troubleshooting Flowchart.

5.3.4 Auxiliary Equipment Isolation Test

This test will need to be performed if the battery pack output voltage is not remaining consistent and no errors were found during the previous Power Supply, Solar Panel Charging System or AC Charging Circuit Tests.

5.3.4.1 Step-by-Step Instructions

- 1) Disconnect the solar panel charger or AC charger from the J17 charger input.
- 2) Disconnect the battery pack cable from J15 on the μ FLO^{G4} board. Substitute a known good battery, if not already performed.
- 3) Disconnect any auxiliary equipment that draws power from the μ FLO^{G4} or the battery pack. This is not limited to, but should include, removing the J10 communication connector, if used.
- 4) Connect the current measurement troubleshooting cable (see Figure 5-6) to a known, good battery. Reconnect to the μ FLO^{G4} board.

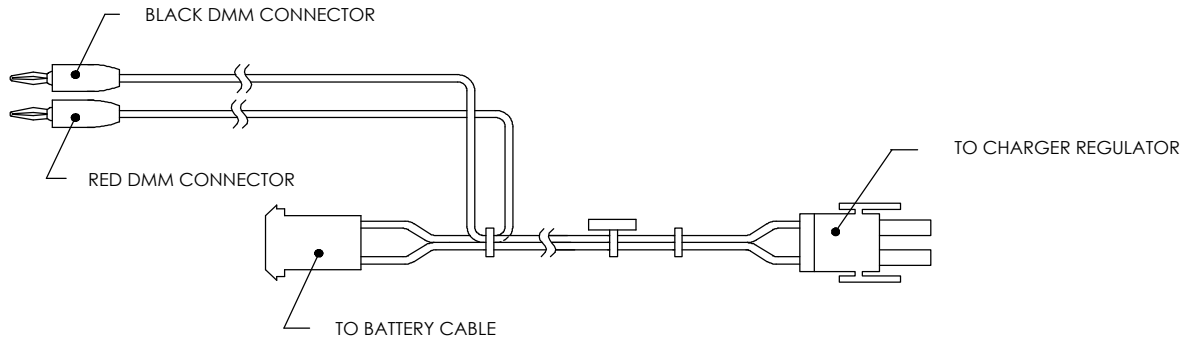

Figure 5-6 Current Measurement Troubleshooting Cable

- 5) Using the DMM, connect to the troubleshooting cable, and measure the average current. If it is equal to or greater than 80 mA at 12 Vdc, disconnect the battery pack and reconnect if one (1) auxiliary item. Continue to the next step.
- 6) If the average current is less than the specification, replace the μ FLO^{G4} board. Follow the procedures detailed in Chapter 4.
- 7) Reconnect the battery pack, and measure the average current. If the average current is less than or equal to the equipment specification, disconnect the battery pack. Upon completion, reconnect to the next auxiliary item. Continue to the next step.
- 8) Repeat step 6 until the auxiliary items have been tested and/or the equipment causing the power drain has been located.
- 9) If the power drain has not been located, return to the Power Troubleshooting Flowchart.

5.3.5 Sleep Mode

The Sleep mode is a safety feature which maintains the RAM but discontinues data measurement calculations and control functions. When the μ FLO^{G4} is in Sleep mode, the word 'SLEEP' is displayed on the LCD. If the μ FLO^{G4} battery voltage falls below 11 Vdc, the μ FLO^{G4} enters Sleep mode.

If the battery voltage is still below 10.9 Vdc, the user should disconnect locally, the μ FLO^{G4} returns to Sleep mode. If the battery voltage is above 11 Vdc, the μ FLO^{G4} remains awake.

The μ FLO^{G4} has a real-time clock which maintains the time and date during Sleep mode and writes an Event record when entering and leaving Sleep mode.

Upon wake-up, the μ FLO^{G4} performs the following functions:

- Stores present calculation period accumulations in historical record.
- Zeros present calculation period accumulations.
- Ends the current daily record and starts a new daily record.

5.3.5.1 Step-by-Step Instructions

- 1) Connect locally to the μ FLO^{G4}. This should wake-up the unit for the user to determine the cause.
- 2) Check the battery pack cable. It must make a good, secure electrical connection with the μ FLO^{G4} board's battery connector, J15 (see Figure 5-5).

- 3) If the battery pack cable is securely connected, check the battery pack voltage. If the voltage is low, replace with another battery pack.

5.3.6 Reset Procedures

The μ FLO^{G4} operating system can be reset through either a cold or warm start procedure. The decision to use these procedures should only be made by an experienced technician.

5.3.6.1 Cold Start

A cold start clears all the data that is stored in RAM as well as resetting all entered variables to their factory default values or to the values last written to the tfCold drive by the Save and Restore utility. A cold start should be used for new μ FLO^{G4} installations. This will ensure that all memory is clear and the operating program is at its default settings. Discretionary use of this procedure is advised.

5.3.6.2 Cold Start Procedure (Hardware)

FYI  Pressing the Reset button with the J16 jumper pulled initiates a cold start.

- 1) If an external charging source is connected, it must be disconnected. Slide the external battery pack charger, J17, from the μ FLO^{G4} board's green terminal block (see Figure 5-5).
- 2) Disconnect the battery back connector from the μ FLO^{G4} board's J15 connector (see Figure 5-5).
- 3) Disable the memory backup. J16, by moving the pin jumper to pins 2 and 3.
- 4) To return to service, reconnect the 12 Vdc battery pack connector to the μ FLO^{G4} board's J15 connector (see Figure 5-5). Upon completion, observe the LCD.
- 5) If removed, reconnect the external battery pack charging source to the J17 connector on the μ FLO^{G4} board.
- 6) Enter all the necessary parameters; otherwise, send a saved station file. To view the procedures for performing these actions, see Chapter 3.
- 7) When the μ FLO^{G4} has been cold started, the 24-hour clock is reset to 00:00:00.
- 8) Enable the memory backup, J16, by moving the pin jumper to pins 1 and 2.

5.3.6.3 Cold Start Procedure (Software)

Where the hardware cold start requires physically disconnecting and reconnecting jumpers from the μ FLO^{G4} board, performing a software cold start involves typing in a command in PCCU32. If an error was made while typing, the user must begin the procedure again.

- 1) Open PCCU32. Upon completion, click the Terminal icon in the main toolbar.
- 2) At the Terminal prompt, type in the following command: boot=COLD

5.3.6.4 Warm Start

A warm start does not clear the data stored in RAM. The warm start will only reset the μ FLO^{G4} microprocessor and will not disturb any data that has been stored in

RAM. A warm start should be used when taking a unit out service to perform maintenance or troubleshooting. A warm start can be used when a power or communication interruption caused the $\mu\text{FLO}^{\text{G4}}$ microprocessor to lock-up.

5.3.6.5 Warm Start Procedure (Hardware)

FYI



Pressing the Reset button with the J16 jumper in the Enabled position initiates a warm start.

- 1) If an external charging source is connected, it must be disconnected. Slide the external battery pack charger, J17, from the $\mu\text{FLO}^{\text{G4}}$ board's green terminal block.
- 2) Enable memory backup, J16, by moving the pin jumper to pins 1 and 2.
- 3) Disconnect the battery pack connector from the $\mu\text{FLO}^{\text{G4}}$ board's J15 connector. The $\mu\text{FLO}^{\text{G4}}$ is now out of service.
- 4) To place the $\mu\text{FLO}^{\text{G4}}$ in service, connect the battery pack connector, J15.
- 5) Connect the external battery pack charger, J17.

5.3.6.6 Warm Start Procedure (Software)

Where the hardware warm start requires physically disconnecting and reconnecting jumpers from the $\mu\text{FLO}^{\text{G4}}$ board, performing a software warm start involves typing in a command in PCCU32. If an error was made while typing, the user must begin the procedure again.

- 1) Open PCCU32. Upon completion, click the Terminal icon in the main toolbar.
- 2) At the Terminal prompt, type in the following command: `boot=WARM`

5.4 Troubleshooting Communications

These troubleshooting procedures are applicable to the $\mu\text{FLO}^{\text{G4}}$ with an installed radio. Use Figure 5-7 as an aid for troubleshooting communication problems. The three basic types of radio communications that can be used between the $\mu\text{FLO}^{\text{G4}}$ and a radio receiver are:

- RS-232 communications with a RS-232 module
- RS-485 communications with a RS-485 module
- RS-422 communications (available, but not detailed)

The radio/modem may be powered one of two ways: always on or switched. The user's specific system setup will determine what steps are needed to power the radio/modem.

When switching power to a radio with Inhibit (Sleep) mode, the communication 1 port or 2 switched power line will go to the radios inhibit (Sleep) mode input. Power out will go to the radios.

CAUTION



Before removal or installation of either the above communication interface modules, it is important to disconnect the $\mu\text{FLO}^{\text{G4}}$ external battery charger and the main $\mu\text{FLO}^{\text{G4}}$ battery pack cable connector from the $\mu\text{FLO}^{\text{G4}}$ board (see Figure 5-5).

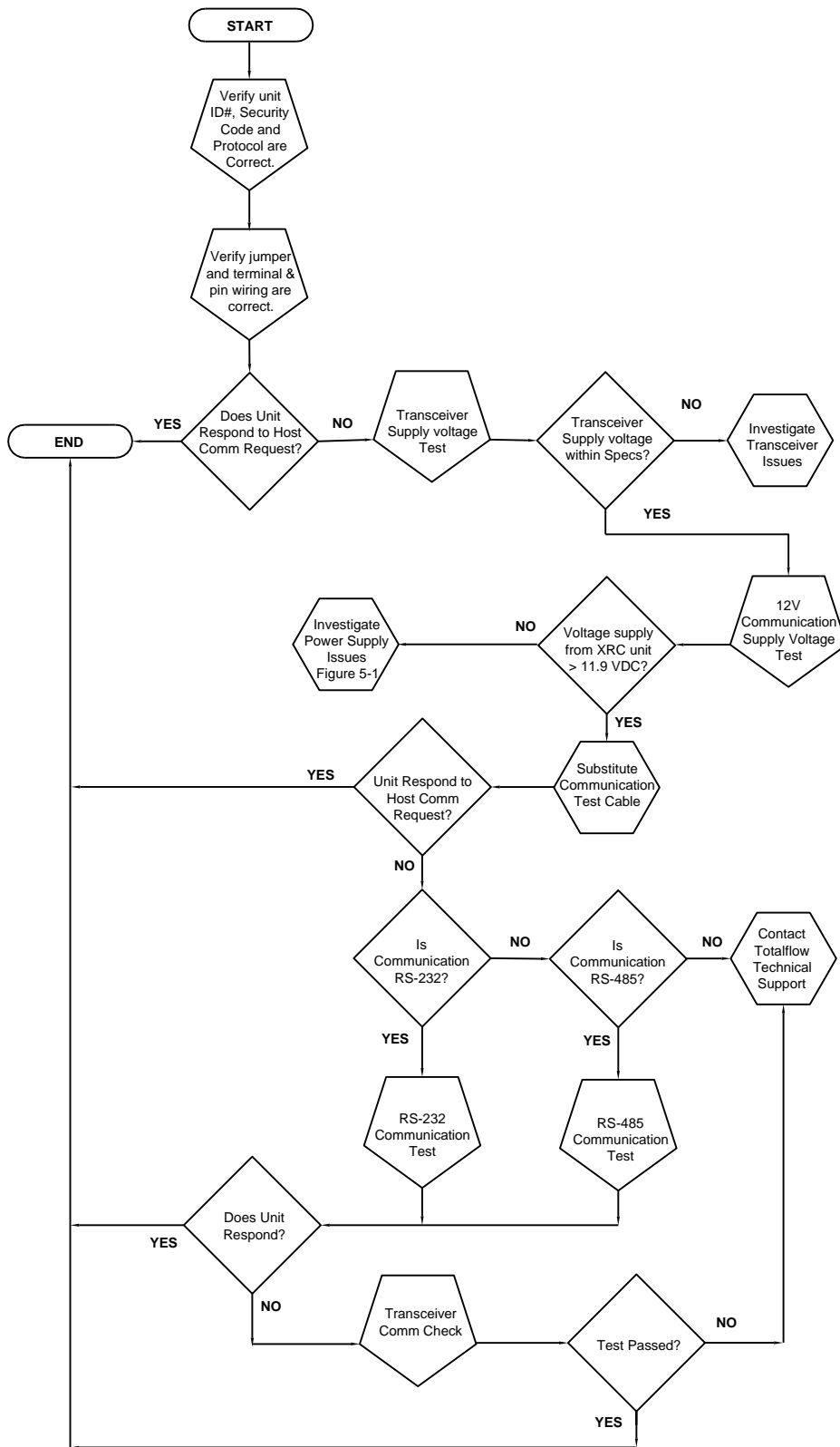

Figure 5-7 Communication Troubleshooting Flowchart

5.4.1 Setting Up Communication

After installation of the communication equipment and before placing the communication system into operation, the user should note the following:

- Verify the RS-232 or RS-485 interface modules and jumpers are installed or set correctly.
- Verify that the radio cable or wiring is correctly installed at the radio.
- Verify the field wiring terminations on the $\mu\text{FLO}^{\text{G4}}$ board.
- Check the $\mu\text{FLO}^{\text{G4}}$ identifier (ID). Log the ID for future reference.
- Log the $\mu\text{FLO}^{\text{G4}}$ access security code, baud rate, listen cycle, protocol and interface for future reference.

The following helpful hints will aid the user after the communication equipment has been installed and set up.

- If the user has the comm port assigned to an annunciator, the $\mu\text{FLO}^{\text{G4}}$ displays the → after it recognized the $\mu\text{FLO}^{\text{G4}}$.
- Check the baud rate of the $\mu\text{FLO}^{\text{G4}}$ transmission and timing. The baud rate and timing settings can be changed when PCCU32 is in Entry mode. Default settings are 1200 baud, listening time is four (4) seconds and communication interface is turned off.
- The minimum power required for operating the remote communications is 11.9 Vdc (default) or as set by the user. Should the power fall below this level, remote communications are terminated.
- Test the remote communications using the RS -232 troubleshooting cable. Use the RS-232 to RS-485 communication converter in conjunction with the RS-232 troubleshooting cable to test the RS-485 remote communications.

FYI



5.4.2 Transceiver Supply Voltage Test

Using the wiring information and guidelines supplied by the transceiver manufacturer, verify that the transceiver is receiving the manufacturer's suggested voltage. If the unit is receiving sufficient voltage, continue to the 12 V Communication Test.

FYI



If the transceiver is not receiving sufficient voltage, investigate the power supply issues. These may involve wiring irregularities at either the AC charger/power supply system or the $\mu\text{FLO}^{\text{G4}}$ board.

5.4.3 12 V Communication Supply Voltage Test

5.4.3.1 Step-by-Step Instructions

If the transceiver does not feature a Sleep mode and the power is supplied through an operational relay, perform step 1.

If the transceiver features a Sleep mode or is continuously powered, perform step 2.

- 1) If the transceiver does not feature a Sleep mode and receives power through the $\mu\text{FLO}^{\text{G4}}$ switched power, activate port 1 Switched Power Out

(pin 3). Using a DMM set to Volts DC, measure the voltage at J10 between: pin 2 (GND) and pin 3 (SWVBAT). See Figure 5-8. The voltage should be greater than 11.9 Vdc for this unit. If the voltage is equal to or less than 11.9 Vdc, return to the test sequence outlined in the Power Troubleshooting Flowchart (see Figure 5-7).

- 2) If the transceiver features a Sleep mode or is continuously powered, use a DMM set to Volts DC, measure the voltage at J10 between: pin 2 (GND) and pin 1 (VBATT). The voltage should be greater than 11.9 Vdc for this unit. If the voltage is equal to or less than 11.9 Vdc, return to the test sequence outlined in the Power Troubleshooting Flowchart (see Figure 5-7).

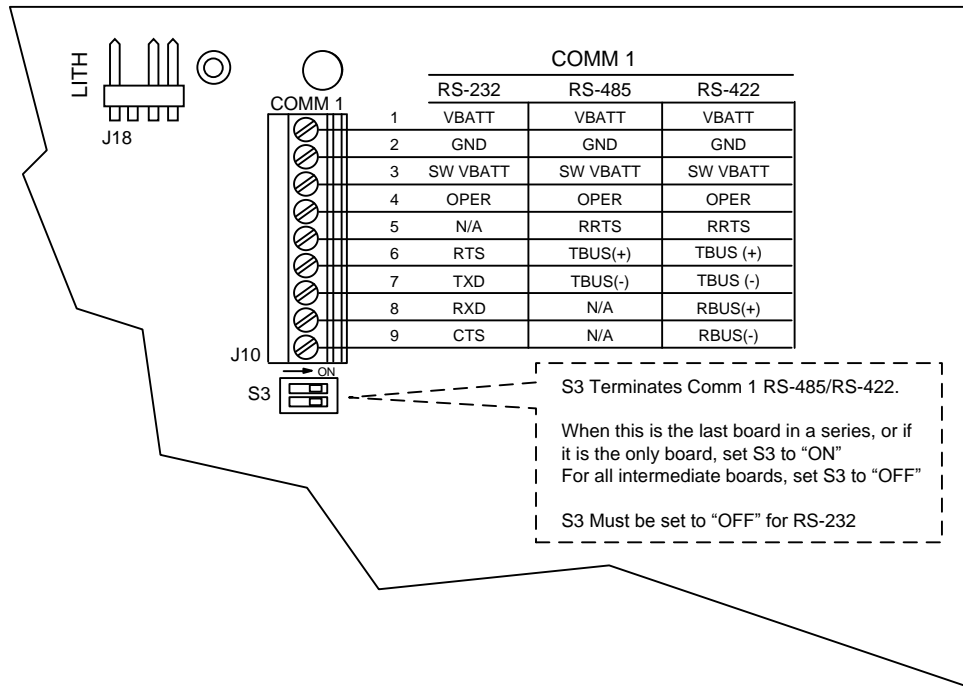

Figure 5-8 μ FLO^{G4} Communication Wiring

5.4.4 Transceiver Check

5.4.4.1 Step-by-Step Instructions

- 1) If available, use a wattmeter to check the transceiver output power. Refer to the manufacturer's documentation for measuring instructions.
- 2) If available, use two (2) hand-held transceivers, and verify the communication path between the master and remote sites. A voice-activated interface can be used, if available.
- 3) Verify that the transceiver is set to the correct frequency. Refer to the manufacturer's documentation for checking frequency instructions.
- 4) If a directional antenna is used, verify the orientation of the antenna to the master site.

FYI



If a communication problem still exists and the unit has passed the transceiver check test, contact ABB Totalflow Technical Support for additional help.

5.4.5 RS-232 Communication Test

The following test procedure will assist the user in deducing possible causes for indicated error messages.

Table 5-3 RS-232 Field Wiring on μ FLO^{G4} Electronic Board

Pin	Description
1	V Battery
2	Ground
3	Switched V Battery
4	Operator
5	N/A
6	RTS
7	TXD
8	RXD
9	CTS

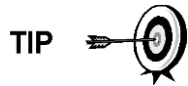

TIP

When troubleshooting RS-232 mode, verify that the termination settings on S3 are both jumpered to OFF.

5.4.5.1 Step-by-Step Instructions

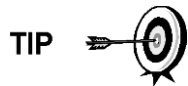

TIP

Voltage on the following steps may be difficult to see using a digital multimeter. If available, an oscilloscope provides a more accurate reading. To verify, the host software must be continuously polling the μ FLO^{G4}.

Generally speaking, the tests performed on the μ FLO^{G4} board will only verify incorrect or damaged wiring. If all previous testing passed and all wiring and jumper and terminations have been verified correct, the board will need to be replaced. Contact ABB Totalflow Technical Support to initiate this process.

- 1) Using an oscilloscope, measure the receiving data (RXD) voltage on the μ FLO^{G4} board's J10 between:

COMM 1, pin 2 (Ground) and COMM 1, pin 8 (Receive Data)

When the unit is receiving data from the host, the voltage should vary between -5 Vdc and +5 Vdc. This indicates that the unit is receiving data. Continue to step 2. If the unit is not receiving data, investigate the wiring issues (see Table 5-3).

- 2) Using an oscilloscope, measure the Request to Send (RTS) voltage on the μ FLO^{G4} board's J10 between:

COMM 1, pin 2 (Ground) and COMM 1, pin 6 (Request to Send)

When the unit is communicating with the host, the voltage should be +5 Vdc and remain +5 Vdc until the μ FLO^{G4} transmit stops. This indicates that the

unit is transmitting data. Continue to step 3. If the unit is not receiving data, investigate the wiring issues (Table 5-3).

- 3) Using an oscilloscope, measure the transmit data (TXD) voltage on the μ FLO^{G4} board's J10 between:

COMM 1, pin 2 (Ground) and COMM 1, pin 7 (Transmit Data)

When the unit is transmitting to the host, the voltage should vary between -5 Vdc and +5 Vdc. This indicates that the unit is transmitting data. If the unit is still not responding, continue to the next test (Figure 5-7).

5.4.6 RS-485 Communication Test

The following test procedure will assist the user in deducing possible causes for indicated error messages.

Before performing this test, please verify that the field wiring is correct (see Table 5-4).

Table 5-4 RS-485 Field Wiring on the μ FLO^{G4} Board

Pin	Description
1	V Battery
2	Ground
3	Switched V Battery
4	Operator
5	RRTS
6	TBUS (+)
7	TBUS (-)0
8	N/A
9	N/A

TIP  When troubleshooting RS-485 mode, verify that the termination settings on S3 are both jumpered to On.

5.4.6.1 Step-by-Step Instructions

TIP  Voltage on the following steps may be difficult to see using a digital multimeter. If available, an oscilloscope provides a more accurate reading. To verify, the host software must be continuously polling the μ FLO^{G4}.

- 1) Using an oscilloscope, measure the driver voltage on the μ FLO^{G4} board's J10 between:

COMM 1, pin 6 (TBUS+) and COMM 1, pin 7 (TBUS-)

When the unit is receiving data from the host, the voltage should vary between +5 Vdc and 0 Vdc. This indicates that the unit is receiving data.

- 2) Using an oscilloscope, measure the Remote Request to Send (RRTS) voltage on the μ FLO^{G4} board's J10 between:
COMM 1, pin 2 (Ground) and COMM 1, pin 5 (RRTS)
When the unit is transmitting data, the voltage should vary between +5 Vdc and 0 Vdc. This indicates that the RRTS is working correctly.
- 3) If an inaccuracy exists, investigate the wiring errors or damaged wires.
- 4) If a communication problem still exist and the unit has passed the tests in steps 1 and 2, additional testing will be required. Call ABB Totalflow Technical Support for additional assistance.



Disconnect the μ FLO^{G4} external battery charger and main μ FLO^{G4} battery pack cable connectors from the μ FLO^{G4} board.

APPENDIX A μ FLO^{G4} MODBUS REGISTER MAPS

ABB Totalflow G4 devices provide access to application data by numeric tags. These numeric tags consist of three (3) values: application number, array number and register number. These three values uniquely identify any accessible application data item. These values are commonly referred to as app.array.register.

A.1 System Application Registers

The format for the register list is app#.array#.register#. The System application is always enabled in application slot 0.

Register	Description	Type	Access	Note
0.0	Board Part Number	String	Read Only	
0.1	Prom Number	String	Read Only	
0.2	Prom Description	String	Read Only	
0.3	System Date/Time	String	Read/Write	
0.4	Device ID	String	Read/Write	
0.5	Location	String	Read/Write	
0.6	Read Level Security Code	String	Read/Write	
0.7	Write Level Security Code	String	Read/Write	
0.8	Server	String	Write Only	
0.9	Account	String	Read/Write	
0.10	Password	String	Read/Write	
0.11	Directory	String	Read/Write	
0.12	IP Address	String	Read/Write	
0.13	DNS Address	String	Read/Write	
0.14	WINS Address	String	Read/Write	
0.15	DNS Name	String	Read/Write	
0.16	Subnet Mask	String	Read/Write	
0.17	Gateway	String	Read/Write	
0.18	OS Part Revision	String	Read Only	
0.19	Log String	String	Write Only	
0.20	Blackfin Firmware #	String	Read Only	
0.21	Login User	String	Read Only	
1.0	Number of App Enumerations	Byte	Read Only	
1.1-(X)	Application Enumerations	Byte	Read Only	1
2.1-(X)	Application Descriptions	String	Read Only	
3.0	Number of Applications	Byte	Read/Write	
3.1-(X)	Application Table	Byte	Read/Write	

Register	Description	Type	Access	Note
4.1-(X)	Application Names	String	Read/Write	
5.1-(X)	Application Revisions	String	Read Only	
6.1-(X)	Application Parameters	String	Read/Write	
7.0	Low Charger	Byte	Read Only	
7.1	Very Low Battery	Byte	Read Only	
7.2	Wakeup (Obsolete)	Byte	Write Only	
7.3	Security Switch	Byte	Read Only	
7.4	System Shutdown	Byte	Read/Write	
7.5	Force Watchdog Reset	Byte	Read/Write	
7.6	Throw Exception	Byte	Read/Write	
7.7	Network Connection	Byte	Read	
7.8	MMI connection State	Byte	Read	
7.9	Watchdog Enable	Byte	Read/Write	
7.10	Lithium Status	Byte	Read	
7.11	Factory Configuration	Byte	Read	
7.12	Ethernet Enable	Byte	Read/Write	
7.13	Slow Clock Mode	Byte	Read/Write	
8.0	Last 2 byte of Prom	Int16	Read Only	
8.1	Year	Int16	Read/Write	
8.2	Month	Int16	Read/Write	
8.3	Day	Int16	Read/Write	
8.4	Hour	Int16	Read/Write	
8.5	Minute	Int16	Read/Write	
8.6	Second	Int16	Read/Write	
8.7	FLASH Checksum	UInt16	Read Only	
9.0	System Date/Time	UInt32	Read Only	
9.1	Available Task Memory	UInt32	Read Only	
9.2	Available RAM File Space	UInt32	Read Only	
9.3	Available Flash File Space	UInt32	Read Only	
9.4	Available SD Card Disk Space	UInt32	Read Only	
9.5	Boot Time	UInt32	Read/Write	
9.6	Tick Count	UInt32	Read Only	
9.7	Enable DHCP	UInt32	Read/Write	
9.8	Update DNS	UInt32	Read/Write	
9.9	Number of Threads	UInt32	Read Only	

Register	Description	Type	Access	Note
9.10	Software Date	UInt32	Read Only	
10.0	Current CPU usage (%)	Float	Read Only	
10.1	Average CPU usage (%)	Float	Read Only	
10.2	Radio Voltage	Float	Read Only	
12.0	Factory Configuration	String	Read Only	
12.1-(X)	Application Part Numbers	String	Read Only	
13.0-(X)	Test Registers			
14.0 -(X)	Thread Handle Array	UInt32	Read Only	
15.0-(X)	Thread Name Array	String	Read Only	
16.0-(X)	Thread % in User Mode	Float	Read Only	
17.0-(X)	Thread priority	UChar	Read Only	
18.0-(X)	Thread Start Time	UInt32	Read Only	
19.0-(X)	App info Data	Struct	Read Only	
20.0-(X)	App restart	UInt32	Read Only	
21.0-(X)	App Update	String	Read Only	
22.0-(X)	App Group	String	Read Only	

A.1.1 System Application Register Notes

1) Standard instantiation slot table:

Application	Instantiation Slot
Spare	255
System App	0
IOS App	1
XFC Display	2
Communications App	3
AGA3 Tube App	4
AGA4 Tube App	5
Liquid tube App	6
Trend App	7
RAMS App	8
Valve Control App	9
Holding Registers App	10
Therms Master App	11
XMV App	12
IEC App	13

Application	Instantiation Slot
Therms Slave App	14
LevelMaster App	15
Pump Interface App	16
Obsolete FS2 App	17
Operations App	18
Host Interface App	19
Selectable Units Gas Orifice Tube App	20
Selectable Units Turbine Tube App	21
Instromet Ultrasonic tube App	22
V-Cone Tube App	23
TotalSonic Tube App	24
TotalSonic Interface App	25
Units Conversion App	26
Enron Aga3 Gas Orifice Tube App	27
Enron AGA7 Pulse Input Tube App	28
Test App	29
Selectable units TotalSonic App	30
Pemex Selectable Units AGA3	31
Pulse Accumulator	32
Selectable Units AGA3 Modbus App	33
Selectable Units AGA7 Modbus App	34
Pemex Selectable Units AGA7 App	35
Valve Control With KDT App	36
Oil Custody Transfer App	37
Selectable Units Liquid Tube App	38
Selectable units Wedge Gas Tube App	39
Chrom App	40
BTU App	41
GCM Interface App	42
Report App	43
NGC I/O Interface App	44
Control App	45
Chrom Post Process App	46
BTU Modbus Slave App	47
NGC LCD Display App	48

Application	Instantiation Slot
Analysis Trend File App	49
Selectable Units Liquid Orifice App	50
Nist14 Gas Equation App	51
Nist14 Liquid Equation App	52
Selectable Units VCONE App	53
ASME IAPWS-IF97 Steam Tube App	54
Coriolis Tube App	55
Plunger Lift Control App	56
Wireless Remote I/O App	57
Coriolis Interface App	58
Safety System App	59
NGC Interface TCP Server	60
NGC Interface TCP Client	61
TGP Modbus App	99
Simulated I/O	100
TFIO Interface App	101
XFC AMU Interface	102

A.2 Display Application Registers

The format for the register list is app#.array#.register#. The Display application can be enabled in any application slot.

REGISTER	DESCRIPTION	TYPE	ACCESS	NOTE
0.0	Number of Files	Byte	Read/Write	1
0.1	Number of Displays	Byte	Read/Write	2
0.2	Current File	Byte	Read/Write	3
0.3	Current Display	Byte	Read/Write	3
0.4	Display Lock	Byte	Read/Write	3
0.5	Display Clear	Byte	Read/Write	4
0.6	Display Save	Byte	Read/Write	5
0.7	Restore Factory Default Display	Byte	Read/Write	6
1.0	File Name (12 Characters)	String	Read/Write	
1.1	Display Name (24 Characters)	String	Read/Write	
1.2	Display Units (14 Characters)	String	Read/Write	
1.3	Display Format (Width.dec)	String	Read/Write	
1.4	Group Description (24 Characters)	String	Read/Write	
2.0	Display Interval (Seconds)	Byte	Read/Write	

REGISTER	DESCRIPTION	TYPE	ACCESS	NOTE
2.1	Name X Location (0-23)	Byte	Read/Write	
2.2	Name Y Location (0-1)	Byte	Read/Write	
2.3	Units X Location (0-23)	Byte	Read/Write	
2.4	Units Y Location (0-1)	Byte	Read/Write	
2.5	Data X Location (0-23)	Byte	Read/Write	
2.6	Data Y Location (0-1)	Byte	Read/Write	
2.7	Annunciator/Plot X Location (0-23)	Byte	Read/Write	
2.8	Annunciator/Plot Y Location (0-1)	Byte	Read/Write	
2.9	Plot Type	Byte	Read/Write	7
2.10	Plot Direction	Byte	Read/Write	8
2.12	Plot Line Width	Byte	Read/Write	
2.13	Plot Border	Byte	Read/Write	9
2.14	Display Attributes	Byte	Read/Write	10
2.15	File Attributes	Byte	Read/Write	11
3.0	Data Scale Factor	Float	Read/Write	
3.1	Data High Limit	Float	Read/Write	
3.2	Data Low Limit	Float	Read/Write	
4.0	Data Register	Register	Read/Write	
4.1	Plot Array Register	Register	Read/Write	12
4.2	Enumeration Array Register	Register	Read/Write	13
4.3	Group Scroll Control Register	Register	Read/Write	14
4.4	Display Scroll Control Register	Register	Read/Write	14
4.5	Locate/Lock Register	Register	Write Only	15
5.0	Scroll Lock Timeout	Uint32	Read/Write	16
5.1	Scroll Lock Timer	Uint32	Read/Write	16
6.0	Annunciator A1	Byte	Read/Write	17
6.1	Annunciator A2	Byte	Read/Write	17
6.2	Annunciator A3	Byte	Read/Write	17
6.3	Annunciator A4	Byte	Read/Write	17
6.4	Annunciator A5	Byte	Read/Write	17
6.5	Annunciator A6	Byte	Read/Write	17
6.6	Annunciator A7	Byte	Read/Write	17
6.7	Annunciator A8	Byte	Read/Write	17
7.0	Display Annunciator A1	Byte	Read/Write	
7.1	Display Annunciator A2	Byte	Read/Write	

REGISTER	DESCRIPTION	TYPE	ACCESS	NOTE
7.2	Display Annunciator A3	Byte	Read/Write	
7.3	Display Annunciator A4	Byte	Read/Write	
7.4	Display Annunciator A5	Byte	Read/Write	
7.5	Display Annunciator A6	Byte	Read/Write	
7.6	Display Annunciator A7	Byte	Read/Write	
7.7	Display Annunciator A8	Byte	Read/Write	
8.(X)	Common Enumerations	String	Read	18

A.2.1 Display Application Register Notes

- 1) If the number of files being written is greater than the number of files present, spare files will be created. If the number written is less than the number present, excess files will be deleted.
- 2) Refers to the number of displays in the current group. If the number written is greater than the number present, spare displays will be created. If the number written is less than the number present, excess displays will be deleted.
- 3) X.0.2 – X.0.4 are used to navigate from group to group and display to display within a group. Setting display lock prevents the display from scrolling.
- 4) Display clear causes the entire display to be refreshed.
- 5) After making changes to the display parameters in arrays 1 through 4, display save should be written to the new parameters in the display file.
- 6) Setting Factory Default causes the display to be set to "Spare".
- 7) 0 = No Plot (Annunciators), 1 = 16x24 pixel, 2 = 8x48 pixel.
- 8) 0 = Left to Right, 1 = Right to Left.
- 9) Bit Mask: Bit 0 = Left, Bit 1 = Right, Bit 2 = Top, Bit 3 = Bottom.
- 10) Bit Mask: Bit 0 = Include in Scroll List, Bit 1 = Allow Keypad Entry, Bit 2 = Validate Keypad entry (Data High/Data Low).
- 11) Bit Mask: Bit 0 = Include in Scroll List, Bit 1 = Allow Keypad Entry.
- 12) Starting Register in an array to plot. Allows historical data (such as last 24 hours or last 24 days) to be plotted. The user can also plot trend data.
- 13) Used to show digital states such as "Open/Close" or "Running/Idle/Stopped".
- 14) Normally used with DIs in "Push to Read" mode. If x.4.3 is assigned, the display will scroll from group to group while the DI is pressed. If x.4.4 is assigned, the display will scroll through displays within the group while the DI is pressed.
- 15) Writing a register (xx.xx.xxxx) to the Locate Register will cause the display system to search all files/displays for the requested register. If it is located, the display containing the register is locked on the display. Used by the Calibrate screen to lock the point being calibrated.
- 16) Allows the display to timeout and resume normal scrolling activity if the operator leaves the display locked for an extended period of time.
- 17) Annunciator Values are determined by the App Type Enumerations. See the System App documentation for an enumeration list.
- 18) These are common enunciators that are used for represented values. i.e.

"Disabled", "Enabled"	// Enabled/Disabled
"Closed", "Open"	// Open/Closed
"False", "True"	// True/False
"Off", "On"	// On/Off

"No", "Yes"

// Yes/No

A.3 Alarm System Application Registers

Format for the register list is app#.array#.register#. The Alarm System application can be enabled in any application slot. Low order array numbers are used for the BTU application. This is due to the fact that the BTU application is derived from a Rams application. Refer to the BTU Application register document.

REGISTER	DESCRIPTION	TYPE	ACCESS	NOTE
100.0-XX	Alarm Records	Structure	Read/Write	1A
101.0-XX	Exception Blocks	Structure	Read/Write	1B
102.0-XX	Float Registers(User settable value)	Structure	Read/Write	1C
103.0	Report Counter	Byte	Read Only	3
103.1	Current Number of Alarms	Byte	Read Only	4
103.2	Alarms Last Reported	Byte	Read Only	5
103.3	Alarm Reset	Byte	Write Only	6
103.4	Auto Clear	Byte	Read/Write	7
103.5	Cry-Out Enable	Byte	Read/Write	8
103.6	Cry-Out Frequency	Byte	Read/Write	9
103.7	Cry-Out Now	Byte	Read Only	10
103.8	Ignore DCD	Byte	Read/Write	11
103.9	Clear Cry-Out Timer	Byte	Write Only	
103.10	Clear Logged Alarms	Byte	Write Only	12
103.11	Cry-Out Timer	Byte	Read/Write	13
103.12	Log Mode	Byte	Read/Write	
103.13	Hold Frequency (In Minutes)	Byte	Read/Write	
103.14	Number of Exception Blocks	Byte	Read/Write	
103.15	Alarms Enabled	Byte	Read/Write	
103.16	Change Alarms Exception Register Apps	Byte	Read/Write	
103.17	Insert a New Exception Block	Byte	Read/Write	
103.18	Delete an Exception Block	Byte	Read/Write	
103.19	Repote Mode	Byte	Read/Write	15
103.20	Aknowledge all	Byte	Read/Write	16
103.21	# Number Logged Alarms Not acknowledge	Byte	Read	
103.22	CPU Load Time Trigger	Byte	Read	
103.23	Last Alarm Code	Byte	Read	
104.0	Get Alarms Report	Structure	Read Only	1
105.0	Get All Alarm Logs	Structure	Read Only	
106.X	Get Specific Alarm Log	Structure	Read Only	17

REGISTER	DESCRIPTION	TYPE	ACCESS	NOTE
107.X	Alarm Type of Alarm at Exception Block X	Byte	Read Only	
108. X	User's Alarm Code of Alarm at Exception Block X	UInt	Read/Write	
109. X	Enable Alarm Flags of Alarm at Exception Block X	Byte	Read/Write	
110. X	Alarm Input Register of Alarm at Exception Block X	Register	Read/Write	
111. X	Alarm Threshold of Alarm at Exception Block X	Register	Read/Write	
112. X	Alarm Output Value of Alarm at Exception Block X	Register	Read/Write	
113. X	Trigger Type of Alarm at Exception Block X	Byte	Read/Write	
114. X	Trigger Reference of Alarm at Exception Block X	Register	Read/Write	
115. X	Reset Alarm Logic of Alarm at Exception Block X	Byte	Read/Write	
116. X	Filter Type of Alarm at Exception Block X	Byte	Read/Write	
117. X	Filter Threshold of Alarm at Exception Block X	Float	Read/Write	
118. X	Filter Units of Alarm at Exception Block X	Byte	Read/Write	
119. X	Log Type of Alarm at Exception Block X	Byte	Read/Write	
120.0	Current Alarm Log Record Position	UInt32	Read/Write	
120.1	Number of Alarm Logs	UInt32	Read/Write	
120.2	CPU Load Hold Off Timer	UInt32	Read	
121. X	Alarm Description of Alarm at Exception Block X	String	Read/Write	
122. X	Current State of Alarm at Exception Block X	Byte	Read Only	
123. X	Alarm Severity of Alarm at Exception Block X	Byte	Read/Write	
124.0	Faults – All RAMS	UInt	Read Only	
124.1	Warnings – All RAMS	UInt	Read Only	
124.2	Faults – This RAM App	UInt	Read Only	
124.3	Warnings– This RAM App	UInt	Read Only	
125. X	Threshold Type of Alarm at Exception Block X	Byte	Read/Write	
126. X	Threshold Constant of Alarm of at Exception Block X	Float	Read/Write	
127.0	Current Active Alarms	Structure	Read Only	
128.0	Current Last Logged Alarm Fault	SInt	Read Only	
128.1	Current Last Logged Alarm Warning	SInt	Read Only	
128.2	Current First Logged Alarm Fault	SInt	Read Only	

REGISTER	DESCRIPTION	TYPE	ACCESS	NOTE
128.3	Current First Logged Alarm Warning	SInt	Read Only	
129.0	Current Last Logged Alarm Fault	String	Read Only	
129.1	Current Last Logged Alarm Warning	String	Read Only	
129.2	Current First Logged Alarm Fault	String	Read Only	
129.3	Current First Logged Alarm Warning	String	Read Only	
129.4	RAMS Port Name	String	Write/Read	
130.0	Transmit Records Only	Structure	Read Only	14
131.X	Alarm Count of currently active alarms of Severity X	UInt	Read Only	
132.X	Alarm Acknowledge	Byte	Read/Write	18
133.X	Get Alarm Acknowledge Log Record	Struct	Read Only	19
134.X	All Alarms Not Acknowledged	Record Struct	Read/Write	20
135.X	All Alarms Not Acknowledged	Record Struct	Read/Write	20
136.X	End of Array	Record Struct	Read/Write	20

A.3.1 Alarm Systems Application Register Notes

- 1) These are special structures used by the Totalflow WinCCU/PCCU32 applications. Currently, they cannot be accessed via templates or ini files.
 - A. XX = MAX_ALARMS = 255
 - B. XX = num_exceptions,user selectable up to 255
 - C. XX = RAMFLTS = 16
- 2) Allows the user to enter floating point numbers as constants that can be used when building an Alarm page. The constants can be compared against variables in the device to generate an alarm.
- 3) Number cry-outs that were not acknowledged by the host.
- 4) Number of alarms that have not been sent and/or alarms that have been sent and not acknowledged by the host.
- 5) Number of alarms in the last successful cry-out. Successful meaning that the cry-out was acknowledged by the host.
- 6) Reset the number of alarms last reported counter.
- 7) Primarily used when polling for alarms or Alarm by Exception. Setting to 1 will cause the alarms to be cleared each time the device is polled for alarms.
- 8) Alarm cry-out is enabled by selecting the port on which alarms will be broadcast. Selections are:
 - 0 – Disabled, 1 - COM1, 2 – COM2
- 9) The time in minutes between cry-outs.
- 10) Set to 1 when it is time to cry-out.
- 11) Cry-out checks the Data Carrier Detect (DCD) line to see if the communications channel is quiet before it initiates a cry-out. This keeps it from transmitting when the host is trying to communicate with the unit. Some communication equipment may not support DCD, and with

nothing connected to the DCD terminal, the DCD input might float to a true state keeping cry-out from transmitting alarms. Setting this register to 1 will instruct cry-out to ignore DCD.

- 12) If the user corrects the situation that is generating an alarm, the user can then set this register to 1 to clear the alarm so that it will not cry-out at the next scheduled cry-out time. This command, however, causes the system to scan immediately for alarms, and if there was another existing alarm condition, it will cry-out immediately instead of waiting for the next scheduled cry-out time.
- 13) The amount of time left before the next scheduled cry-out as specified by the cry-out frequency.
- 14) Used to append Rams alarms to be transmitted to an existing remote alarm record.
- 15) Report Mode Poll=1 Cry Out=0.
- 16) Acknowledge All Alarms any value sets this byte.
- 17) X= the specific alarm log to get.
- 18) X = the alarm number (0-255).
- 19) X = the alarm number (0-255). Returns 0 filled structure, if already acknowledged.
- 20) X = arbitrary value. Returns all un-acknowledged alarm logs.

A.4 Holding Registers

Format for the register list is app#.array#.register#. The Holding Registers application can be enabled in any application slot.

REGISTER	DESCRIPTION	TYPE	ACCESS	NOTE
0.0	Holding Array 1 Register 1	Programmable	Read/Write	1
0.1	Holding Array 1 Register 2	Programmable	Read/Write	1
0.2	Holding Array 1 Register 3	Programmable	Read/Write	1
0.(X)	Holding Array 1 Register (X)	Programmable	Read/Write	1
1.0	Holding Array 2 Register 1	Programmable	Read/Write	1
1.1	Holding Array 2 Register 2	Programmable	Read/Write	1
1.2	Holding Array 2 Register 3	Programmable	Read/Write	1
1.(X)	Holding Array 2 Register (X)	Programmable	Read/Write	1
2.0	Holding Array 3 Register 1	Programmable	Read/Write	1
2.1	Holding Array 3 Register 2	Programmable	Read/Write	1
2.2	Holding Array 3 Register 3	Programmable	Read/Write	1
2.(X)	Holding Array 3 Register (X)	Programmable	Read/Write	1
(X).0	Holding Array (X) Register 1	Programmable	Read/Write	1
(X).1	Holding Array (X) Register 2	Programmable	Read/Write	1
(X).2	Holding Array (X) Register 3	Programmable	Read/Write	1
(X).(X)	Holding Array (X) Register (X)	Programmable	Read/Write	1
100.0	Holding Array 1 Register 0 Description	String	Read/Write	
100.1	Holding Array 1 Register 1 Description	String	Read/Write	
100.(X)	Holding Array 1 Register (X) Description	String	Read/Write	
101.0	Holding Array 2 Register 0 Description	String	Read/Write	
101.1	Holding Array 2 Register 1 Description	String	Read/Write	

REGISTER	DESCRIPTION	TYPE	ACCESS	NOTE
101.(X)	Holding Array 2 Register (X) Description	String	Read/Write	
10(X).0	Holding Array (X) Register 0 Description	String	Read/Write	
10(X).1	Holding Array (X) Register 1 Description	String	Read/Write	
10(X).(X)	Holding Array (X) Register (X) Description	String	Read/Write	
251.0	Array 1 Descriptor Flag	Byte	Read Only	2
251.1	Array 2 Descriptor Flag	Byte	Read Only	2
251.2	Array 3 Descriptor Flag	Byte	Read Only	2
251.(X)	Array (X) Descriptor Flag	Byte	Read Only	2
252.0	Holding Array 1 Description	String	Read/Write	3
252.1	Holding Array 2 Description	String	Read/Write	3
252.2	Holding Array 3 Description	String	Read/Write	3
252.(X)	Holding Array (X) Description	String	Read/Write	3
253.0	Holding Array 1 Data Type	Byte	Read/Write	4
253.1	Holding Array 2 Data Type	Byte	Read/Write	4
253.2	Holding Array 3 Data Type	Byte	Read/Write	4
253.(X)	Holding Array (X) Data Type	Byte	Read/Write	4
254.0	Holding Array 1 Persistence	Byte	Read/Write	4
254.1	Holding Array 2 Persistence	Byte	Read/Write	4
254.2	Holding Array 3 Persistence	Byte	Read/Write	4
254.(X)	Holding Array (X) Persistence	Byte	Read/Write	4
255.0	Holding Array 1 Capacity	Uint16	Read/Write	5
255.1	Holding Array 2 Capacity	Uint16	Read/Write	5
255.2	Holding Array 3 Capacity	Uint16	Read/Write	5
255.(X)	Holding Array (X) Capacity	Uint16	Read/Write	5
255.255	Number of Holding Arrays	Uint16	Read/Write	6

A.4.1 Holding Register Notes

- 1) The number, type and size of the Holding Register arrays are user programmable.
- 2) Array descriptor flag indicates if the array has a descriptor contained in array 252.
- 3) Each Holding Register array can be assigned a 24-character name.
- 4) The data type of each Holding Register array is user programmable. The following data types are supported:
 - 0 - 32 Bit Floating Point
 - 1 - 16 Bit Integer
 - 2 - 16 Bit Unsigned Integer
 - 3 - 32 Bit Integer
 - 4 - 32 Bit Unsigned Integer
 - 5 - 8 Bit Byte

- 6 - 24 Character String
- 7 - 4 Byte Register (app.array.register)

- 5) Each Holding Register array can be made persistent through a warm start. If the array persistence flag is set to 1, each write operation to a register in the array causes the array data to be written to a file. This can be very slow. It will also increase processor usage considerably. If registers in an array are being updated frequently, the array should not be made persistent.
- 6) The number of registers in each Holding Register array is limited only by available memory.
- 7) Up to 250 Holding Register arrays can be allocated; however, available memory will probably be exhausted first.

A.5 Reports Application Registers

The format for the register lists is app#.array#.register#. The Reports application can be enabled in any application slot.

REGISTER	DESCRIPTION	TYPE	ACCESS	NOTE
0.0-6	BYTE Registers	BYTE		
0.0	Baud Rate	BYTE	Read/Write	
0.1	Data Bits	BYTE	Read/Write	
0.2	Parity	BYTE	Read/Write	
0.3	Stop Bits	BYTE	Read/Write	
0.4	Interface	BYTE	Read/Write	
0.5	Port Type	BYTE	Read/Write	
0.6	Trigger Byte	BYTE	Read/Write	
1.0-1	Int16 Registers	16 Bit Int		
1.0	Radio Key Delay	16 Bit Int	Read/Write	
1.1	Radio Unkey Delay	16 Bit Int	Read/Write	
2.0-0	Int32 Registers	32 Bit Int		
2.0	Timeout	32 Bit Int	Read/Write	
3.0-1	String Registers	String		
3.0	Report ID	String	Read/Write	
3.1	Report Port Name	String	Read/Write	
4.0-0	Float Registers	Float		
4.0	Float Accumulator	Float	Read	
5.0 – 5.31	Output Files	String	Read/Write	
6.0 – 6.31	Template Files	String	Read/Write	
7.0 – (X)	BTU Apps Trigger Registers	String	Read/Write	
8.0 – 8.31	Header Files	String	Read/Write	
9.0 – 9.31	Report Modes	Byte	Read/Write	1
10.0 – 10.31	Analysis Times	Int32	Read/Write	

A.5.1 Reports Register Notes

- 1) Auto, Manual Disabled, Triggered.

A.6 Operations Application Registers

Format for the register list is app#.array#.register#. The Operations application can be enabled in any application slot.

Register	Description	Type	Access	Note
0.0	Periodic Operations 1 Trigger Register	Register	Read/Write	1
0.1	Periodic Operations 2 Trigger Register	Register	Read/Write	1
0.2	Periodic Operations 3 Trigger Register	Register	Read/Write	1
0.(X)	Periodic Operations (X) Trigger Register	Register	Read/Write	1
1.0	Periodic Operations 1 Trigger Type	Byte	Read/Write	1
1.1	Periodic Operations 2 Trigger Type	Byte	Read/Write	1
1.2	Periodic Operations 3 Trigger Type	Byte	Read/Write	1
1.(X)	Periodic Operations (X) Trigger Type	Byte	Read/Write	1
2.0	Periodic Operations 1 Trigger Interval	Uint32	Read/Write	1
2.1	Periodic Operations 2 Trigger Interval	Uint32	Read/Write	1
2.2	Periodic Operations 3 Trigger Interval	Uint32	Read/Write	1
2.(X)	Periodic Operations (X) Trigger Interval	Uint32	Read/Write	1
3.0	Periodic Operations 1 Operation	Byte	Read/Write	2
3.1	Periodic Operations 2 Operation	Byte	Read/Write	2
3.2	Periodic Operations 3 Operation	Byte	Read/Write	2
3.(X)	Periodic Operations (X) Operation	Byte	Read/Write	2
4.0	Periodic Operations 1 Register 1	Register	Read/Write	2
4.1	Periodic Operations 2 Register 1	Register	Read/Write	2
4.2	Periodic Operations 3 Register 1	Register	Read/Write	2
4.(X)	Periodic Operations (X) Register 1	Register	Read/Write	2
5.0	Periodic Operations 1 Register 2	Register	Read/Write	2
5.1	Periodic Operations 2 Register 2	Register	Read/Write	2
5.2	Periodic Operations 3 Register 2	Register	Read/Write	2
5.(X)	Periodic Operations (X) Register 2	Register	Read/Write	2
6.0	Periodic Operations 1 Output Register	Register	Read/Write	2
6.1	Periodic Operations 2 Output Register	Register	Read/Write	2
6.2	Periodic Operations 3 Output Register	Register	Read/Write	2
6.(X)	Periodic Operations (X) Output Register	Register	Read/Write	2
7.0	Math Operation 1 Result	Float	Read Only	3
7.1	Math Operation 2 Result	Float	Read Only	3

Register	Description	Type	Access	Note
7.2	Math Operation 3 Result	Float	Read Only	3
7.(X)	Math Operation (X) Result	Float	Read Only	3
8.0	Math Operation 1 Operation	Byte	Read/Write	3
8.1	Math Operation 2 Operation	Byte	Read/Write	3
8.2	Math Operation 3 Operation	Byte	Read/Write	3
8.(X)	Math Operation (X) Operation	Byte	Read/Write	3
9.0	Math Operation 1 Register 1	Register	Read/Write	3
9.1	Math Operation 2 Register 1	Register	Read/Write	3
9.2	Math Operation 3 Register 1	Register	Read/Write	3
9.(X)	Math Operation (X) Register 1	Register	Read/Write	3
10.0	Math Operation 1 Register 2	Register	Read/Write	3
10.1	Math Operation 2 Register 2	Register	Read/Write	3
10.2	Math Operation 3 Register 2	Register	Read/Write	3
10.(X)	Math Operation (X) Register 2	Register	Read/Write	3
11.0	Bit Operation 1 Result	Uint32	Read Only	4
11.1	Bit Operation 2 Result	Uint32	Read Only	4
11.2	Bit Operation 3 Result	Uint32	Read Only	4
11.(X)	Bit Operation (X) Result	Uint32	Read Only	4
12.0	Bit Operation 1 Operation	Byte	Read/Write	4
12.1	Bit Operation 2 Operation	Byte	Read/Write	4
12.2	Bit Operation 3 Operation	Byte	Read/Write	4
12.(X)	Bit Operation (X) Operation	Byte	Read/Write	4
13.0	Bit Operation 1 Register 1	Register	Read/Write	4
13.1	Bit Operation 2 Register 1	Register	Read/Write	4
13.2	Bit Operation 3 Register 1	Register	Read/Write	4
13.(X)	Bit Operation (X) Register 1	Register	Read/Write	4
14.0	Bit Operation 1 Register 2	Register	Read/Write	4
14.1	Bit Operation 2 Register 2	Register	Read/Write	4
14.2	Bit Operation 3 Register 2	Register	Read/Write	4
14.(X)	Bit Operation (X) Register 2	Register	Read/Write	4
15.0	Compare Operation 1 Result	Bool	Read Only	5
15.1	Compare Operation 2 Result	Bool	Read Only	5
15.2	Compare Operation 3 Result	Bool	Read Only	5
15.(X)	Compare Operation (X) Result	Bool	Read Only	5
16.0	Compare Operation 1 Operation	Uint16	Read/Write	5

Register	Description	Type	Access	Note
16.1	Compare Operation 2 Operation	Uint16	Read/Write	5
16.2	Compare Operation 3 Operation	Uint16	Read/Write	5
16.(X)	Compare Operation (X) Operation	Uint16	Read/Write	5
17.0	Compare Operation 1 Register 1	Register	Read/Write	5
17.1	Compare Operation 2 Register 1	Register	Read/Write	5
17.2	Compare Operation 3 Register 1	Register	Read/Write	5
17.(X)	Compare Operation (X) Register 1	Register	Read/Write	5
18.0	Compare Operation 1 Register 2	Register	Read/Write	5
18.1	Compare Operation 2 Register 2	Register	Read/Write	5
18.2	Compare Operation 3 Register 2	Register	Read/Write	5
18.(X)	Compare Operation (X) Register 2	Register	Read/Write	5
19.0	Array Operation 1 Result	Float	Read Only	6
19.1	Array Operation 2 Result	Float	Read Only	6
19.2	Array Operation 3 Result	Float	Read Only	6
19.(X)	Array Operation (X) Result	Float	Read Only	6
20.0	Array Operation 1 Operation	Uint16	Read/Write	6
20.1	Array Operation 2 Operation	Uint16	Read/Write	6
20.2	Array Operation 3 Operation	Uint16	Read/Write	6
20.(X)	Array Operation (X) Operation	Uint16	Read/Write	6
21.0	Array Operation 1 Register	Register	Read/Write	6
21.1	Array Operation 2 Register	Register	Read/Write	6
21.2	Array Operation 3 Register	Register	Read/Write	6
21.(X)	Array Operation (X) Register	Register	Read/Write	6
22.0	Array Operation 1 Size	Uint16	Read/Write	6
22.1	Array Operation 2 Size	Uint16	Read/Write	6
22.2	Array Operation 3 Size	Uint16	Read/Write	6
22.(X)	Array Operation (X) Size	Uint16	Read/Write	6
23.0	Periodic Operation 1 Descriptor	String	Read/Write	12
23.1	Periodic Operation 2 Descriptor	String	Read/Write	12
23.2	Periodic Operation 3 Descriptor	String	Read/Write	12
23.(X)	Periodic Operation (X) Descriptor	String	Read/Write	12
24.0	Math Operation 1 Descriptor	String	Read/Write	12
24.1	Math Operation 2 Descriptor	String	Read/Write	12
24.2	Math Operation 3 Descriptor	String	Read/Write	12
24.(X)	Math Operation (X) Descriptor	String	Read/Write	12

Register	Description	Type	Access	Note
25.0	Bit Operation 1 Descriptor	String	Read/Write	12
25.1	Bit Operation 2 Descriptor	String	Read/Write	12
25.2	Bit Operation 3 Descriptor	String	Read/Write	12
25.(X)	Bit Operation (X) Descriptor	String	Read/Write	12
26.0	Compare Operation 1 Descriptor	String	Read/Write	12
26.1	Compare Operation 2 Descriptor	String	Read/Write	12
26.2	Compare Operation 3 Descriptor	String	Read/Write	12
26.(X)	Compare Operation (X) Descriptor	String	Read/Write	12
27.0	Array Operation 1 Descriptor	String	Read/Write	12
27.1	Array Operation 2 Descriptor	String	Read/Write	12
27.2	Array Operation 3 Descriptor	String	Read/Write	12
27.(X)	Array Operation (X) Descriptor	String	Read/Write	12
28.0	Select Operation 1 Descriptor	String	Read/Write	12
28.1	Select Operation 2 Descriptor	String	Read/Write	12
28.2	Select Operation 3 Descriptor	String	Read/Write	12
28.(X)	Select Operation (X) Descriptor	String	Read/Write	12
29.0	Select Operation 1 Switch	Register	Read/Write	13
29.1	Select Operation 2 Switch	Register	Read/Write	13
29.2	Select Operation 3 Switch	Register	Read/Write	13
29.(X)	Select Operation (X) Switch	Register	Read/Write	13
30.0	Select Operation 1 Input 1	Register	Read/Write	13
30.1	Select Operation 2 Input 1	Register	Read/Write	13
30.2	Select Operation 3 Input 1	Register	Read/Write	13
30.(X)	Select Operation (X) Input 1	Register	Read/Write	13
31.0	Select Operation 1 Input 2	Register	Read/Write	13
31.1	Select Operation 2 Input 2	Register	Read/Write	13
31.2	Select Operation 3 Input 2	Register	Read/Write	13
31.(X)	Select Operation (X) Input 2	Register	Read/Write	13
32.0	Select Operation 1 Output	Float	Read/Write	13
32.1	Select Operation 2 Output	Float	Read/Write	13
32.2	Select Operation 3 Output	Float	Read/Write	13
32.(X)	Select Operation (X) Output	Float	Read/Write	13
33.0	Lag Operation 1 Description	String	Read/Write	12
33.1	Lag Operation 2 Description	String	Read/Write	12
33.2	Lag Operation 3 Description	String	Read/Write	12

Register	Description	Type	Access	Note
33.(X)	Lag Operation (X) Description	String	Read/Write	12
34.0	Lag Operation 1 Interval	UInt32	Read/Write	14
34.1	Lag Operation 2 Interval	UInt32	Read/Write	14
34.2	Lag Operation 3 Interval	UInt32	Read/Write	14
34.(X)	Lag Operation (X) Interval	UInt32	Read/Write	14
35.0	Lag Operation 1 Input Register	Register	Read/Write	14
35.1	Lag Operation 2 Input Register	Register	Read/Write	14
35.2	Lag Operation 3 Input Register	Register	Read/Write	14
35.(X)	Lag Operation (X) Input Register	Register	Read/Write	14
36.0	Lag Operation 1 Output	Float	Read/Write	14
36.1	Lag Operation 2 Output	Float	Read/Write	14
36.2	Lag Operation 3 Output	Float	Read/Write	14
36.(X)	Lag Operation (X) Output	Float	Read/Write	14
37.0	Lead Operation 1 Description	String	Read/Write	12
37.1	Lead Operation 2 Description	String	Read/Write	12
37.2	Lead Operation 3 Description	String	Read/Write	12
37.(X)	Lead Operation (X) Description	String	Read/Write	12
38.0	Lead Operation 1 Interval	UInt32	Read/Write	15
38.1	Lead Operation 2 Interval	UInt32	Read/Write	15
38.2	Lead Operation 3 Interval	UInt32	Read/Write	15
38.(X)	Lead Operation (X) Interval	UInt32	Read/Write	15
39.0	Lead Operation 1 Input Register	Register	Read/Write	15
39.1	Lead Operation 2 Input Register	Register	Read/Write	15
39.2	Lead Operation 3 Input Register	Register	Read/Write	15
39.(X)	Lead Operation (X) Input Register	Register	Read/Write	15
40.0	Lead Operation 1 Output	Float	Read/Write	15
40.1	Lead Operation 2 Output	Float	Read/Write	15
40.2	Lead Operation 3 Output	Float	Read/Write	15
40.(X)	Lead Operation (X) Output	Float	Read/Write	15
41.0	Queue Operation 1 Descriptor	String	Read/Write	12
41.1	Queue Operation 2 Descriptor	String	Read/Write	12
41.2	Queue Operation 3 Descriptor	String	Read/Write	12
41.(X)	Queue Operation (X) Descriptor	String	Read/Write	12
42.0	Queue Operation 1 Interval	UInt32	Read/Write	16
42.1	Queue Operation 2 Interval	UInt32	Read/Write	16

Register	Description	Type	Access	Note
42.2	Queue Operation 3 Interval	Uint32	Read/Write	16
42.(X)	Queue Operation (X) Interval	Uint32	Read/Write	16
43.0	Queue Operation 1 Array Register	Register	Read/Write	16
43.1	Queue Operation 2 Array Register	Register	Read/Write	16
43.2	Queue Operation 3 Array Register	Register	Read/Write	16
43.(X)	Queue Operation (X) Array Register	Register	Read/Write	16
44.0	Queue Operation 1 Array Size	Uint16	Read/Write	16
44.1	Queue Operation 2 Array Size	Uint16	Read/Write	16
44.2	Queue Operation 3 Array Size	Uint16	Read/Write	16
44.(X)	Queue Operation (X) Array Size	Uint16	Read/Write	16
45.0	Queue Operation 1 Input Register	Register	Read/Write	16
45.1	Queue Operation 2 Input Register	Register	Read/Write	16
45.2	Queue Operation 3 Input Register	Register	Read/Write	16
45.(X)	Queue Operation (X) Input Register	Register	Read/Write	16
46.0	Queue Operation 1 Output	Float	Read/Write	16
46.1	Queue Operation 2 Output	Float	Read/Write	16
46.2	Queue Operation 3 Output	Float	Read/Write	16
46.(X)	Queue Operation (X) Output	Float	Read/Write	16
47.0	Ramp Operation 1 Descriptor	String	Read/Write	12
47.1	Ramp Operation 2 Descriptor	String	Read/Write	12
47.2	Ramp Operation 3 Descriptor	String	Read/Write	12
47.(X)	Ramp Operation (X) Descriptor	String	Read/Write	12
48.0	Ramp Operation 1 Slope	Float	Read/Write	17
48.1	Ramp Operation 2 Slope	Float	Read/Write	17
48.2	Ramp Operation 3 Slope	Float	Read/Write	17
48.(X)	Ramp Operation (X) Slope	Float	Read/Write	17
49.0	Ramp Operation 1 Input Register	Register	Read/Write	17
49.1	Ramp Operation 2 Input Register	Register	Read/Write	17
49.2	Ramp Operation 3 Input Register	Register	Read/Write	17
49.(X)	Ramp Operation (X) Input Register	Register	Read/Write	17
50.0	Ramp Operation 1 Output	Float	Read/Write	17
50.1	Ramp Operation 2 Output	Float	Read/Write	17
50.2	Ramp Operation 3 Output	Float	Read/Write	17
50.(X)	Ramp Operation (X) Output	Float	Read/Write	17
51.0	Pulse Operation 1 Descriptor	String	Read/Write	12

Register	Description	Type	Access	Note
51.1	Pulse Operation 2 Descriptor	String	Read/Write	12
51.2	Pulse Operation 3 Descriptor	String	Read/Write	12
51.(X)	Pulse Operation (X) Descriptor	String	Read/Write	12
52.0	Pulse Operation 1 Interval	Uint32	Read/Write	18
52.1	Pulse Operation 2 Interval	Uint32	Read/Write	18
52.2	Pulse Operation 3 Interval	Uint32	Read/Write	18
52.(X)	Pulse Operation (X) Interval	Uint32	Read/Write	18
53.0	Pulse Operation 1 Trigger Register	Register	Read/Write	18
53.1	Pulse Operation 2 Trigger Register	Register	Read/Write	18
53.2	Pulse Operation 3 Trigger Register	Register	Read/Write	18
53.(X)	Pulse Operation (X) Trigger Register	Register	Read/Write	18
54.0	Pulse Operation 1 Trigger Flags	Byte	Read Only	18
54.1	Pulse Operation 2 Trigger Flags	Byte	Read Only	18
54.2	Pulse Operation 4 Trigger Flags	Byte	Read Only	18
54.(X)	Pulse Operation (X) Trigger Flags	Byte	Read Only	18
55.0	Pulse Operation 1 Output	Float	Read/Write	18
55.1	Pulse Operation 2 Output	Float	Read/Write	18
55.2	Pulse Operation 4 Output	Float	Read/Write	18
55.(X)	Pulse Operation (X) Output	Float	Read/Write	18
56.0	Limit Operation 1 Descriptor	String	Read/Write	12
56.1	Limit Operation 2 Descriptor	String	Read/Write	12
56.2	Limit Operation 3 Descriptor	String	Read/Write	12
56.(X)	Limit Operation (X) Descriptor	String	Read/Write	12
57.0	Limit Operation 1 High Limit	Float	Read/Write	19
57.1	Limit Operation 2 High Limit	Float	Read/Write	19
57.2	Limit Operation 3 High Limit	Float	Read/Write	19
57.(X)	Limit Operation (X) High Limit	Float	Read/Write	19
58.0	Limit Operation 1 Low Limit	Float	Read/Write	19
58.1	Limit Operation 2 Low Limit	Float	Read/Write	19
58.2	Limit Operation 3 Low Limit	Float	Read/Write	19
58.(X)	Limit Operation (X) Low Limit	Float	Read/Write	19
59.0	Limit Operation 1 Velocity	Float	Read/Write	19
59.1	Limit Operation 2 Velocity	Float	Read/Write	19
59.2	Limit Operation 3 Velocity	Float	Read/Write	19
59.(X)	Limit Operation (X) Velocity	Float	Read/Write	19

Register	Description	Type	Access	Note
60.0	Limit Operation 1 Input Register	Register	Read/Write	19
60.1	Limit Operation 2 Input Register	Register	Read/Write	19
60.2	Limit Operation 3 Input Register	Register	Read/Write	19
60.(X)	Limit Operation (X) Input Register	Register	Read/Write	19
61.0	Limit Operation 1 Output	Float	Read/Write	19
61.1	Limit Operation 2 Output	Float	Read/Write	19
61.2	Limit Operation 3 Output	Float	Read/Write	19
61.(X)	Limit Operation (X) Output	Float	Read/Write	19
62.0	Scale Operation 1 Descriptor	String	Read/Write	12
62.1	Scale Operation 2 Descriptor	String	Read/Write	12
62.2	Scale Operation 3 Descriptor	String	Read/Write	12
62.(X)	Scale Operation (X) Descriptor	String	Read/Write	12
63.0	Scale Operation 1 Input High Limit	Float	Read/Write	20
63.1	Scale Operation 2 Input High Limit	Float	Read/Write	20
63.2	Scale Operation 3 Input High Limit	Float	Read/Write	20
63.(X)	Scale Operation (X) Input High Limit	Float	Read/Write	20
64.0	Scale Operation 1 Input Low Limit	Float	Read/Write	20
64.1	Scale Operation 2 Input Low Limit	Float	Read/Write	20
64.2	Scale Operation 3 Input Low Limit	Float	Read/Write	20
64.(X)	Scale Operation (X) Input Low Limit	Float	Read/Write	20
65.0	Scale Operation 1 Output High Limit	Float	Read/Write	20
65.1	Scale Operation 2 Output High Limit	Float	Read/Write	20
65.2	Scale Operation 3 Output High Limit	Float	Read/Write	20
65.(X)	Scale Operation (X) Output High Limit	Float	Read/Write	20
66.0	Scale Operation 1 Output Low Limit	Float	Read/Write	20
66.1	Scale Operation 2 Output Low Limit	Float	Read/Write	20
66.2	Scale Operation 3 Output Low Limit	Float	Read/Write	20
66.(X)	Scale Operation (X) Output Low Limit	Float	Read/Write	20
67.0	Scale Operation 1 Input Register	Register	Read/Write	20
67.1	Scale Operation 2 Input Register	Register	Read/Write	20
67.2	Scale Operation 3 Input Register	Register	Read/Write	20
67.(X)	Scale Operation (X) Input Register	Register	Read/Write	20
68.0	Scale Operation 1 Output	Float	Read/Write	20
68.1	Scale Operation 2 Output	Float	Read/Write	20
68.2	Scale Operation 3 Output	Float	Read/Write	20

Register	Description	Type	Access	Note
68.(X)	Scale Operation (X) Output	Float	Read/Write	20
69.0	PID Operation 1 Descriptor	String	Read/Write	12
69.1	PID Operation 2 Descriptor	String	Read/Write	12
69.2	PID Operation 3 Descriptor	String	Read/Write	12
69.(X)	PID Operation (X) Descriptor	String	Read/Write	12
70.0	PID Operation 1 Input Register	Register	Read/Write	21
70.1	PID Operation 2 Input Register	Register	Read/Write	21
70.2	PID Operation 3 Input Register	Register	Read/Write	21
70.(X)	PID Operation (X) Input Register	Register	Read/Write	21
71.0	PID Operation 1 Setpoint	Float	Read/Write	21
71.1	PID Operation 2 Setpoint	Float	Read/Write	21
71.2	PID Operation 3 Setpoint	Float	Read/Write	21
71.(X)	PID Operation (X) Setpoint	Float	Read/Write	21
72.0	PID Operation 1 Dead Band	Float	Read/Write	21
72.1	PID Operation 2 Dead Band	Float	Read/Write	21
72.2	PID Operation 2 Dead Band	Float	Read/Write	21
72.(X)	PID Operation (X) Dead Band	Float	Read/Write	21
73.0	PID Operation 1 Proportional Gain	Float	Read/Write	21
73.1	PID Operation 2 Proportional Gain	Float	Read/Write	21
73.2	PID Operation 2 Proportional Gain	Float	Read/Write	21
73.(X)	PID Operation (X) Proportional Gain	Float	Read/Write	21
74.0	PID Operation 1 Integral Reset	Float	Read/Write	21
74.1	PID Operation 2 Integral Reset	Float	Read/Write	21
74.2	PID Operation 3 Integral Reset	Float	Read/Write	21
74.(X)	PID Operation (X) Integral Reset	Float	Read/Write	21
75.0	PID Operation 1 Derivative Rate	Float	Read/Write	21
75.1	PID Operation 2 Derivative Rate	Float	Read/Write	21
75.2	PID Operation 3 Derivative Rate	Float	Read/Write	21
75.(X)	PID Operation (X) Derivative Rate	Float	Read/Write	21
76.0	PID Operation 1 Mode	Uchar	Read/Write	21
76.1	PID Operation 2 Mode	Uchar	Read/Write	21
76.2	PID Operation 3 Mode	Uchar	Read/Write	21
76.(X)	PID Operation (X) Mode	Uchar	Read/Write	21
77.0	PID Operation 1 Action	Uchar	Read/Write	21
77.1	PID Operation 2 Action	Uchar	Read/Write	21

Register	Description	Type	Access	Note
77.2	PID Operation 3 Action	Uchar	Read/Write	21
77.(X)	PID Operation (X) Action	Uchar	Read/Write	21
78.0	PID Operation 1 Output	Float	Read/Write	21
78.1	PID Operation 2 Output	Float	Read/Write	21
78.2	PID Operation 3 Output	Float	Read/Write	21
78.(X)	PID Operation (X) Output	Float	Read/Write	21
255.0	Number of Periodic Operations	Uint16	Read/Write	7
255.1	Number of Math Operations	Uint16	Read/Write	8
255.2	Number of Bit Operations	Uint16	Read/Write	9
255.3	Number of Compare Operations	Uint16	Read/Write	10
255.4	Number of Array Operations	Uint16	Read/Write	11
255.5	Enable Period Descriptors	Uint16	Read/Write	22
255.6	Enable Math Descriptors	Uint16	Read/Write	22
255.7	Enable Bit Descriptors	Uint16	Read/Write	22
255.8	Enable Compare Descriptors	Uint16	Read/Write	22
255.9	Enable Array Descriptors	Uint16	Read/Write	22
255.10	Number of Select Operations	Uint16	Read/Write	23
255.11	Enable Select Descriptors	Uint16	Read/Write	22
255.12	Number of Lag Operations	Uint16	Read/Write	24
255.13	Enable Lag Descriptors	Uint16	Read/Write	22
255.14	Number of Lead Operations	Uint16	Read/Write	25
255.15	Enable Lead Descriptors	Uint16	Read/Write	22
255.16	Number of Queue Operations	Uint16	Read/Write	26
255.17	Enable Queue Descriptors	Uint16	Read/Write	22
255.18	Number of Ramp Operations	Uint16	Read/Write	27
255.19	Enable Ramp Descriptors	Uint16	Read/Write	22
255.20	Number of Pulse Operations	Uint16	Read/Write	28
255.21	Enable Pulse Descriptors	Uint16	Read/Write	22
255.22	Number of Limit Operations	Uint16	Read/Write	29
255.23	Enable Limit Descriptors	Uint16	Read/Write	22
255.24	Number of Scale Operations	Uint16	Read/Write	30
255.25	Enable Scale Descriptors	Uint16	Read/Write	22
255.26	Number of PID Operations	Uint16	Read/Write	31
255.27	Enable PID Descriptors	Uint16	Read/Write	22

A.6.1 Operations Application Register Notes

- 1) Periodic Operations can be executed at a cyclic interval (such as every five seconds), at a specific time of day (such as 8:00) or they can be triggered by another register. If the operation trigger type in array 1 is 0 (Interval), the operation is executed at the interval specified by the corresponding register in array 2. If the operation trigger type is 1 (Time), the operation is executed at the time of day specified by the corresponding register in array 2. If the operation trigger type is 2 (Triggered), the operation is executed each second if the register specified by the corresponding register in array 0 is non-zero.
- 2) Periodic Operations combine the capabilities of Math, Bit, Compare and Array operations. The registers in array 3 contain operation codes specifying the operation to be performed. The registers in arrays 4 and 5 contain the operands of the operations. The registers in array 6 specify where the results of the operations will be placed. The following operation codes are supported:

- 0 - No Operation
- 1 - $R1 + R2$ (Addition)
- 2 - $R1 - R2$ (Subtraction)
- 3 - $R1 * R2$ (Multiplication)
- 4 - $R1 / R2$ (Division)
- 5 - $R1 ^ R2$ (Power of)
- 6 - $\text{sqrt}(R1)$ (Square Root)
- 7 - $\text{sin}(R1)$ (Trig Sine)
- 8 - $\text{cos}(R1)$ (Trig Cosine)
- 9 - $\text{tan}(R1)$ (Trig Tangent)
- 10 - $\text{ABS}(R1)$ (Remove sign)
- 11 - $\text{Log}(R1)$ (Logarithm)
- 12 - $1 / R1$ (Reciprocal)
- 13 - $R1 \% R2$ (Modulo)
- 20 - $R1 \& R2$ (Bitwise AND)
- 21 - $R1 | R2$ (Bitwise OR)
- 22 - $R1 ^ R2$ (Bitwise XOR)
- 23 - $R1 \sim R2$ (Bitwise Complement)
- 24 - $R1 \ll R2$ (Bitwise Shift Left)
- 25 - $R1 \gg R2$ (Bitwise Shift Right)
- 26 - $R1 = !R2$ (Bitwise NOT)
- 30 - $(R1 \& R2) == 0$ (True if Equal to Zero)
- 31 - $(R1 \& R2) != 0$ (True if Not Equal to Zero)
- 32 - $(R1 | R2) == 0$ (True if Equal to Zero)
- 33 - $(R1 | R2) != 0$ (True if Not Equal to Zero)
- 34 - $(R1 ^ R2) == 0$ (True if Equal to Zero)
- 35 - $(R1 ^ R2) != 0$ (True if Not Equal to Zero)
- 40 - $R1 == R2$ (True if Equal)
- 41 - $R1 != R2$ (True if Not Equal)
- 42 - $R1 > R2$ (True if Greater than)
- 43 - $R1 >= R2$ (True if Greater than or equal to)
- 44 - $R1 < R2$ (True if Less than)
- 45 - $R1 <= R2$ (True if Less than or equal to)
- 46 - $R1 == 0$ (True if Equal to zero)
- 47 - $R1 != 0$ (True if Not Equal to zero)
- 48 - $R1 > 0$ (True if Greater than zero)
- 49 - $R1 < 0$ (True if Less than zero)
- 60 - Integer $R1 + R2$ (Addition)
- 61 - Integer $R1 - R2$ (Subtraction)
- 62 - Integer $R1 * R2$ (Multiplication)
- 63 - Integer $R1 / R2$ (Division)
- 64 - Integer $\text{abs}(R1)$ (Remove sign)

- 65 - Integer $R1 \% R2$ (Modulo)
- 70 - Array Addition
- 71 - Array Linear Average
- 72 - Array Square Root Average
- 73 - Array Minimum
- 74 - Array Maximum
- 80 - Copy Array
- 81 - Move Array
- 254 - Out = R2 = R1
- 255 - Out = R1

- 3) Math Operations are executed when the corresponding register in array 7 is read. The registers in array 8 contain operation codes specifying the math operation to be performed. The registers in arrays 9 and 10 contain the operands of the operations. The result of the math operation is returned in the corresponding register in array 7. The following math operation codes are supported:

- 0 - No Operation
- 1 - $R1 + R2$ (Addition)
- 2 - $R1 - R2$ (Subtraction)
- 3 - $R1 * R2$ (Multiplication)
- 4 - $R1 / R2$ (Division)
- 5 - $R1 ^ R2$ (Power of)
- 6 - $\text{sqrt}(R1)$ (Square Root)
- 7 - $\sin(R1)$ (Trig Sine)
- 8 - $\cos(R1)$ (Trig Cosine)
- 9 - $\tan(R1)$ (Trig Tangent)
- 10 - $\text{ABS}(R1)$ (Remove sign)
- 11 - $\text{Log}(R1)$ (Logarithm)
- 12 - $1 / R1$ (Reciprocal)
- 13 - $R1 \% R2$ (Modulo)

- 4) Bit Operations are executed when the corresponding register in array 11 is read. The registers in array 12 contain operation codes specifying the bit operation to be performed. The registers in arrays 13 and 14 contain the operands of the operations. The result of the bit operation is returned in the corresponding register in array 11. The following bit operation codes are supported:

- 20 - $R1 \& R2$ (Bitwise AND)
- 21 - $R1 | R2$ (Bitwise OR)
- 22 - $R1 ^ R2$ (Bitwise XOR)
- 23 - $R1 \sim R2$ (Bitwise Complement)
- 24 - $R1 \ll R2$ (Bitwise Shift Left)
- 25 - $R1 \gg R2$ (Bitwise Shift Right)
- 26 - $R1 = !R2$ (Bitwise NOT)
- 30 - $(R1 \& R2) == 0$ (True if Equal to Zero)
- 31 - $(R1 \& R2) != 0$ (True if Not Equal to Zero)
- 32 - $(R1 | R2) == 0$ (True if Equal to Zero)
- 33 - $(R1 | R2) != 0$ (True if Not Equal to Zero)
- 34 - $(R1 ^ R2) == 0$ (True if Equal to Zero)
- 35 - $(R1 ^ R2) != 0$ (True if Not Equal to Zero)

- 5) Compare Operations are executed when the corresponding register in array 15 is read. The registers in array 16 contain operation codes specifying the compare operation to be performed. The registers in arrays 17 and 18 contain the operands of the operations. The result of the compare operation is returned in the corresponding register in array 15. The following compare operation codes are supported:

- 40 - $R1 == R2$ (True if Equal)
 - 41 - $R1 != R2$ (True if Not Equal)
 - 42 - $R1 > R2$ (True if Greater than)
 - 43 - $R1 >= R2$ (True if Greater than or equal to)
 - 44 - $R1 < R2$ (True if Less than)
 - 45 - $R1 <= R2$ (True if Less than or equal to)
 - 46 - $R1 == 0$ (True if Equal to zero)
 - 47 - $R1 != 0$ (True if Not Equal to zero)
 - 48 - $R1 > 0$ (True if Greater than zero)
 - 49 - $R1 < 0$ (True if Less than zero)
- 6) Array Operations are executed when the corresponding register in array 19 is read. The registers in array 20 contain operation codes specifying the array operation to be performed. The registers in arrays 21 and 22 contain the operands of the array operations. The result of the operation is returned in the registers in array 19. The following operation codes are supported:
 - 70 - Array Addition
 - 71 - Array Linear Average
 - 72 - Array Square Root Average
 - 73 - Array Minimum
 - 74 - Array Maximum
 - 80 - Copy Array
 - 81 - Move Array
 - 7) Register 255.0 contains the number of Periodic Operations. It determines the size of arrays 0 through 6 and 23.
 - 8) Register 255.1 contains the number of Math Operations. It determines the size of arrays 7 through 10 and 24.
 - 9) Register 255.2 contains the number of Bit Operations. It determines the size of arrays 11 through 14 and 25.
 - 10) Register 255.3 contains the number of Compare Operations. It determines the size of arrays 15 through 18 and 26.
 - 11) Register 255.4 contains the number of Array Operations. It determines the size of arrays 19 through 22 and 27.
 - 12) These registers only exist if 255.5 thru 9 , 11, 13, 15, 17, 19, 21, 23, 25 and 27 are set to a 1 (or Yes).
 - 13) Select Operations are executed when the corresponding register in array 32 is read. The registers in array 29 contain the value that is used to switch the output between two input values. The registers in arrays 30 and 31 contain the inputs to the operation. The result of the select operation is returned in the corresponding register in array 32.
 - 14) Lag Operations are executed when the corresponding register in array 36 is read. The registers in array 34 contain the value that is used as the lag interval . The register in array 35 contains the input to the operation. The result of the lag operation is returned in the corresponding register in array 36.
 - 15) Lead Operations are executed when the corresponding register in array 40 is read. The registers in array 38 contain the value that is used as the lead interval. The register in array 39 contains the input to the operation. The result of the lead operation is returned in the corresponding register in array 40.
 - 16) Queue Operations are executed when the corresponding register in array 46 is read. The registers in array 42 contain the value that is used as the queue interval. The register in array 45 contains the input to the operation. The register in array 43 specifies the starting register address for the array. The register in array 44 specifies the number of registers in the array. The result of the queue operation is returned in the corresponding register in array 46.
 - 17) Ramp Operations are executed when the corresponding register in array 50 is read. The registers in array 48 contain the value that is used as the slope. The register in array 39 contains

the input to the operation. The result of the ramp operation is returned in the corresponding register in array 50.

- 18) Pulse Operations are executed when the corresponding register in array 55 is read. The registers in array 52 contain the value that is used as the pulse interval. The register in array 53 contains the trigger input. The result of the pulse operation is returned in the corresponding register in array 55.
- 19) Limit Operations are executed when the corresponding register in array 61 is read. The registers in array 60 contain the input to the operation. The registers in array 57 are used as the high limit values for the input data. The registers in array 58 are used as the low limit values for the input data. The registers in array 59 specify the value in engineering units per second that the output is allowed to change in response to the input. The result of the limit operation is returned in the corresponding register in array 61.
- 20) Scale Operations are executed when the corresponding register in array 68 is read. The registers in array 67 contain the input to the operation. The registers in array 63 are used as the high limit values for the input data. The registers in array 64 are used as the low limit values for the input data. The registers in array 65 are used as the high limit values for the output data. The registers in array 66 are used as the low limit values for the output data. The result of the scale operation is returned in the corresponding register in array 68.
- 21) PID Operations are executed when the corresponding register in array 78 is read. The registers in array 70 contain the input to the operation. The registers in array 71 are used as the set points for the operation. The registers in array 72 are used as the dead band values for the set points and the inputs. The registers in array 73 are used as the proportional gain of the operation. The registers in array 74 are used as the integral reset values of the operation. The registers in array 75 are used as the derivative rate of the operation. The registers in array 76 are used for the auto (1) / manual (0) mode of the operation. The registers in array 77 are used for the action (direct =0, reverse=1) of the operation. The result of the PID operation is returned in the corresponding register in array 78.
- 22) The value in this register is either a 0 to disable associated descriptors or a 1 to enable the associated descriptors.
- 23) Register 255.10 contains the number of Select Operations. It determines the size of arrays 28 thru 32.
- 24) Register 255.12 contains the number of Lag Operations. It determines the size of arrays 33 thru 36.
- 25) Register 255.14 contains the number of Lead Operations. It determines the size of arrays 37 thru 40.
- 26) Register 255.16 contains the number of Queue Operations. It determines the size of arrays 41 thru 46.
- 27) Register 255.18 contains the number of Ramp Operations. It determines the size of arrays 47 thru 50.
- 28) Register 255.20 contains the number of Pulse Operations. It determines the size of arrays 51 thru 55.
- 29) Register 255.22 contains the number of Limit Operations. It determines the size of the arrays 56 thru 61.
- 30) Register 255.24 contains the number of Scale Operations. It determines the size of the arrays 62 thru 68.
- 31) Register 255.26 contains the number of PID Operations. It determines the size of the arrays 69 thru 78.

A.7 Communication Application Registers

Format for the register list is app#.array#.register#. The Communications application can be enabled in any application slot.

REGISTER	DESCRIPTION	TYPE	ACCESS	NOTE
0.0	Port Flags Reset/Initialize Flags	Byte	Read/Write	1
0.1	Interface Type (RS-232/485/422)	Byte	Read/Write	2
0.2	Baud Rate	Byte	Read/Write	3
0.3	Number of Data Bits	Byte	Read/Write	4
0.4	Parity	Byte	Read/Write	5
0.5	Number of Stop Bits	Byte	Read/Write	6
0.6	Protocol	Byte	Read/Write	19
0.7	Link Establishment Interval	Byte	Read/Write	8
0.8	Wait for download timeout(seconds)	Byte	Read/Write	
0.9	Scheduler Mode	Byte	Read/Write	9
0.10	Exception Retry Limit	Byte	Read/Write	
0.11	MODBUS Slave Address	Byte	Read/Write	
0.12	MODBUS Register Format	Byte	Read/Write	10
0.13	Host Retry Limit	Byte	Read/Write	
0.14	Communications Task Priority	Byte	Read/Write	1
0.15	Switched V-Batt Enable	Byte	Read/Write	
0.16	Pager On/Off	Byte	Read/Write	
0.17	Trailing Pad Characters	Byte	Read/Write	12
0.18	Modem Mode (ASCII/BINARY)	Byte	Read/Write	
0.19	Packet Trace Enable	Byte	Read/Write	13
0.20	Interface On/Off	Byte	Read/Write	
0.21	ISR Thread Priority	Byte	Read/Write	
0.22	Port Type	Byte	Read/Write	20
0.23	Port Open	Byte	Read/Write	
0.24	Keep Port Open Flag	Byte	Read/Write	
0.25	Modbus Host Scan Enabled	Byte	Read/Write	
0.40	Port Name	Byte	Read/Write	
0.50				
1.0	Power-Up Delay (Milli-Seconds)	Uint16	Read/Write	
1.1	Transmit Key Delay (Milli-Seconds)	Uint16	Read/Write	
1.2	Transmit Unkey Delay (ms)	Uint16	Read/Write	
1.3	Timeout (Milli-Seconds)	Uint16	Read/Write	
1.4	Modem Inactivity Timeout(Minutes)	Uint16	Read/Write	
1.5	Modem Connect Timeout(Seconds)	Uint16	Read/Write	
1.6	Modem Disconnect Timeout(Seconds)	Uint16	Read/Write	

REGISTER	DESCRIPTION	TYPE	ACCESS	NOTE
1.7	MODBUS Group (Assigned)	Uint16	Read/Write	14
1.8	MODBUS Group (Current)	Uint16	Read/Write	14
1.9	TCP Port (Socket)	Uint16	Read/Write	
1.10	Response Delay (Before Raising RTS)	Uint16	Read/Write	
1.11	Record Number	Uint16	Read/Write	
2.0	Schedule Start Time	Uint32	Read/Write	15
2.1	Schedule Stop Time	Uint32	Read/Write	15
2.2	Schedule Cycle Interval	Uint32	Read/Write	15
2.3	Schedule Duration	Uint32	Read/Write	15
2.4	Number of Polls	Uint32	Read/Write	16
2.5	Number of Errors	Uint32	Read/Write	16
2.6	Number of Fall Behinds	Uint32	Read/Write	16
2.7	Number of Initializations	Uint32	Read/Write	16
2.8	Modbus Host Poll Loop Time	Uint32	Read/Write	
2.9	Modbus Host Poll Loop Min Time	Uint32	Read/Write	
2.10	Modbus Host Poll Loop Max Time	Uint32	Read/Write	
2.11	Number of Interrupts	Uint32	Read/Write	
2.12	Number of Received Characters	Uint32	Read/Write	
2.13	Number of Transmitted Characters	Uint32	Read/Write	
2.14	Port Status	Uint32	Read	
3.0	Modbus Directory	String	Read/Write	17
3.1	Modem Dial String	String	Read/Write	
3.2	Modem Initialization String	String	Read/Write	
3.3	Serial Comm Port Name	String	Read/Write	
3.4	TCP/IP Address	String	Read/Write	
3.5	PassThru Second Port	String	Read/Write	
4.0	Request/Response Timing DO	Register	Read/Write	19
5.0	Number of supported protocols	Byte	Read Only	19
5.1-(X)	Protocol Enumerations	Byte	Read Only	19
6.1-(X)	Protocol Descriptions	String	Read Only	19

A.7.1 Communication Application Register Notes

- 1) Use only as directed by Totalflow support.
- 2) 0 = RS-232, 1 = RS-485, 2 = RS-422, 64 = Modem.
- 3) 0 = 1200, 1 = 2400, 2 = 4800, 3 = 9600, 4 = 19200, 5 = 38400, 6 = 57600, 7 = 115200.
- 4) Only 5, 7 or 8 Data bits supported.

- 5) 0 = None, 1 = Even, 2 = Odd.
- 6) 1 or 2 Stop Bits.
- 7) 0 = COM0 , 1 = COM1 , 2 = COM2, -1 = None.
- 8)
- 9) 0 = 4 seconds, 1 = 2 seconds, 2 = 1 seconds, 3 = Always On.
- 10) 1 = Time of Day, 2 = Time of Day/Cycle.
- 11) 0 = 32 Bit Totalflow, 64 = 32 Bit, 65 = 16 Bit Word Swapped, 66 = 16 Bit Modicon, 68 = 16 Bit ROS Modulo 10000.
- 12) Use only as directed by Totalflow support.
- 13) Used by many host protocols (MODBUS Host, ADP Host, ETS Host...). Appends NULL characters to transmitted packets.
- 14) Prints packets received/transmitted. Not supported by all protocols. To print packets on COM0: x.0.19=1; to print on COM1: x.0.19=2; to print on COM3: x.0.19=3. To disable packet dump, x.0.19=0.
- 15) Because of the addressing limitations of MODBUS, some SCADA systems assign devices to groups. To use this feature, configure the device's group by setting x.1.7. The SCADA host broadcast writes the current group to x.1.8. Only devices assigned to the current group respond to their slave address.
- 16) Communications Schedule is used to conserve power during times of inactivity.
- 17) Not all protocols maintain communications statistics.
- 18) Some protocols scan a directory for request blocks or register maps. If the user prefers to share a register map across ports, change the protocol directory to point to a common directory.
- 19) By assigning this register to a digital output, an oscilloscope can be used to measure protocol request/response timing. When using multiple XMV's on a common bus, this can be used to verify each device is reliably being scanned once a second (API 21.1 compliance).
- 20) All FLASH images do not contain all protocols. Register x.5.0 contains the number of protocols in the FLASH image. Registers x.5.1 through x.5.(x.5.0) contains the protocol type codes each protocol in the FLASH image. Registers x.6.1 through x.6.(x.5.0) contain the text descriptions for each protocol in the FLASH image.

Protocol	Enumeration	Description
No Protocol	255	No protocol used
TFLocal	0	Typical MMI/Serial connection
TFRemote	2	Remote Protocol Used by radios or secondary Serial Port on Board
Terminal	3	General Terminal mode used by serial devices
Modbus Slave ASCII	1	Modbus Slave for ASCII encoding
Modbus Slave RTU	5	Modbus Slave for RTU encoding
Modbus Host ASCII	8	Modbus Host for ASCII encoding
Modbus Host RTU	9	Modbus Host for RTU encoding
Tank Gauge	7	Protocol used for LevelMaster
Totalflow TCP	10	General Totalflow Ethernet protocol
Modbus TCP Client	11	Protocol for TCP Modbus Response client
Modbus TCP Server	12	Protocol for TCP Modbus Request Server

Protocol	Enumeration	Description
Totalflow BlueTooth	13	BlueTooth Protocol for the Totalflow device
PassThru	51	Enable Port signal pass through
Alicat	52	

21) Port Type is referenced as TCP/IP=1 or Serial=0.

A.8 Safety Controller Application Registers

A.8.1 Array Types

Ary.Reg	Type	Size	Description	Note
0.x	String	25 char	See individual register descriptions	
1.x	Unsigned byte	8 bits	See individual register descriptions	
2.x	Register Address	32 bits	See individual register descriptions	
3.x	Boolean	8 bits	See individual register descriptions	
4.x	Floating point	32 bits	See individual register descriptions	
5.x	Unsigned long	32 bits	See individual register descriptions	
6.x	Unsigned byte	8 bits	Fail Reason[x]	1,6
7.x	Unsigned byte	8 bits	Fail Reason Index[x]	1
10.0-x	Register Address	32 bits	AI Address [x]	2
11.0-x	String	25 char	AI Name[x]	2
12.0-x	Floating Point	32 bits	AI Value[x]	2
13.0-x	Floating Point	32 bits	AI High Limit[x]	2
14.0-x	Floating Point	32 bits	AI Low Limit[x]	2
15.0-x	Boolean	8 bits	AI High Alarm[x]	2
16.0-x	Boolean	8 bits	AI Low Alarm[x]	2
17.0-x	Boolean	8 bits	AI Reset Holdoff [x]	2,10
18.0-x	Unsigned Integer	16 bits	AI Time Limit[x]	2
19.0-x	Unsigned Integer	16 bits	AI Timer [x]	2
20.0-x	Register Address	32 bits	DI Address [x]	3
21.0-x	String	25 char	DI Name[x]	3
22.0-x	Boolean	8 bits	DI Value[x]	3
23.0-x	Boolean	8 bits	DI Polarity[x]	3,9
24.0-x	Boolean	8 bits	DI Alarm[x]	3
25.0-x	Boolean	8 bits	DI Reset Holdoff[x]	3,10
30.0-x	Unsigned byte	8 bits	Well[x] Application Number (Plunger)	4
31.0-x	Unsigned byte	8 bits	Well[x] State (0-6)	4,7
32.0-x	Unsigned byte	8 bits	Well[x] Status (Enable)	4,8

Ary.Reg	Type	Size	Description	Note
33.0-x	Boolean	8 bits	Well [x] Option Shutdown	4,10
34.0-x	Boolean	8 bits	Well [x] Option Schedule	4,10
35.0-x	Boolean	8 bits	Well [x] Adr State	4
36.0-x	Register Address	32 bits	Well [x] Adr Status	4, 5
37.0-x	Register Address	32 bits	Well [x] Adr Hold DO	4, 5
38.0-x	Register Address	32 bits	Well [x] Adr Fail Reason DO	4, 5
39.0-x	Register Address	32 bits	Well [x] Adr Reset DO	4, 5

A.8.2 General Registers

A.8.2.1 String Registers (x.0.x) 25 Characters

Ary.Reg	Description	Usage	Note
0.0	Program Name	R/W:	
0.1	Program Revision	Read:	
0.2	State String	Read:	

A.8.2.2 Byte Registers (x.1.x) 8-Bits

Ary.Reg	Description	Usage	Note
1.0	n/u	R/W:	
1.1	Option Safety	R/W:	8
1.2	Clear Log	R/W:	10
1.3	AI Size	R/W:	
1.4	DI Size	R/W:	
1.5	Well Size	R/W:	
1.6	Manual Timer	Read:	
1.7	Manual Limit (secs)	R/W:	
1.8	Option Well Schedule	R/W:	10
1.9	Well Open - Max	R/W	
1.10	Well Open – Current	R/W	
1.11	Well Schedule Algorithm	R/W	11
1.12	Well Next to Open (or last opened)	R/W	

A.8.2.3 Register Addresses (x.2.x) 32-Bits

Ary.Reg	Description	Usage	Note
2.0	Safety Reset Button	R/W:	
2.1	Power Monitor AI	R/W:	
2.2	Shutdown Status: DO	R/W:	

Ary.Reg	Description	Usage	Note
2.3	Remote Shutdown DI	R/W:	

A.8.2.4 Boolean Registers (x.3.x) 8-Bits

Ary.Reg	Description	Usage	Note
3.0	Safety State	Read:	
3.1	Reset Safety State	Read:	
3.2	Safety Reset Button	R/W:	
3.3	Cal Hold	Read:	
3.4	Power Low Alarm	Read:	
3.5	Power High Alarm	Read:	
3.6	Safety State Output	Read:	
3.7	Remote Shutdown Value	R/W:	

A.8.2.5 Floating Point Registers (x.4.x)

Ary.Reg	Description	Usage	Note
4.0	Power Value	R/W:	
4.1	Power Low Setpoint	R/W:	
4.2	Power High Setpoint	R/W:	

A.8.2.6 Ulong (x.5.x) 32-Bits

Ary.Reg	Description	Usage	Note
5.0-9	Fail Timestamp[1-10]	Read:	
5.10	Reset Timer	Read	
5.11	Reset Limit	R/W	
5.12	Reset Timestamp	Read:	
5.13	Well Open Delay - Timer	Read:	
5.14	Well Open Delay - Limit	R/W	

A.8.3 Safety Controller Registers Notes

- 1) Array size 10 x=0-(size-1)
- 2) Array size varies with AI count x=0-(size-1)
- 3) Array size varies with DI count x=0-(size-1)
- 4) Array size varies with Well count x=0-(size-1)
- 5) Value will automatically be set by set Application number(30.x)
- 6) Fail Reason:

None	0
Plunger Failed to Arrive	1
Power Low	2

None	0
DI x	3
AI x LOW	4
AI x HIGH	5
REMOTE	6
DISABLE	7
RESET	8

7) Plunger State:

FAIL	0
Closing Valve	1
Valve Closed	2
Plunger Arriving	3
Blow Valve	4
Plunger Arrived	5
AfterFlow	6

8) Enable:

Disabled	0
Manual	1
Enabled	2

9) Polarity:

Low Alarm	0
High Alarm	1

10) Option:

Disabled	0
Enabled	1

11) Algorithm:

Priority	0
Round Robin	1

A.9 μ FLO^{G4} IOS Application Registers

A.10 AGA-3 Measurement Tube Application Registers

Tube measurement applications share several common data items. The items listed under this heading are common to all tube measurement applications. Usage and notes are specific to AGA-3 tube applications. Format for the register list is .array#.register# description. The Application number depends on the order of the application's instantiation.

A.10.1 AGA-3 Tube Byte Registers

ARRAY.REGISTER	DESCRIPTION	USAGE
0.0	Contract Hour	Read/Write, 0-23
0.1	Reset Volume Command	Write
0.2	Reset Log Period Command	Write
0.3	Calibration Hold Mode	Read/Write
0.4	AP/DP/TF Over Range Flags	Read Only
0.5	Tube Database Rev	Read Only
0.6	AGA-3 1985 Dynamic Select Bits	Read/Write, used only for AGA-3, 1985, other tubes or calculation methods ignore this value, See note 1)
0.7	AGA-3 1992 Static Select Bits	Read/Write, used only for AGA-3, 1992, other tubes or calculation methods ignore this value, See note 2)
0.8	AGA-3 1992 Dynamic Select Bits	Read/Write, used only for AGA-3, 1992, other tubes or calculation methods ignore this value, See note 3)
0.9	Volume Calc Type	Read/Write, see note 4)
0.10	Calc Units	Read Only
0.11	Report Units	Read Only
0.12	Super Compressibility Method	Read/Write, see note 5)
0.13	Use Square Root Average flag	Read/Write
0.14	Characteristic Record Type	Read/Write, see note 6)
0.15	Use Fixed H2O	Read/Write, for Fw calculation
0.16	Gravity Config flags	Read/Write, live analysis configuration, see note 7)
0.17	BTU Config flags	Read/Write, live analysis configuration, see note 7)
0.18	Nitrogen Config flags	Read/Write, live analysis configuration, see note 7)
0.19	Carbon Dioxide Config flags	Read/Write, live analysis configuration, see note 7)
0.20	Hydrogen Sulfide Config flags	Read/Write, live analysis configuration, see note 7)
0.21	Water Config flags	Read/Write, live analysis configuration, see note 7)
0.22	Helium Config flags	Read/Write, live analysis configuration, see note 7)
0.23	Methane Config flags	Read/Write, live analysis configuration, see note 7)

ARRAY.REGISTER	DESCRIPTION	USAGE
0.24	Ethane Config flags	Read/Write, live analysis configuration, see note 7)
0.25	Propane Config flags	Read/Write, live analysis configuration, see note 7)
0.26	Normal Butane Config flags	Read/Write, live analysis configuration, see note 7)
0.27	Iso-Butane Config flags	Read/Write, live analysis configuration, see note 7)
0.28	Normal Pentane Config flags	Read/Write, live analysis configuration, see note 7)
0.29	Iso-Pentane Config flags	Read/Write, live analysis configuration, see note 7)
0.30	Normal Hexane Config flags	Read/Write, live analysis configuration, see note 7)
0.31	Normal Heptane Config flags	Read/Write, live analysis configuration, see note 7)
0.32	Normal Octane Config flags	Read/Write, live analysis configuration, see note 7)
0.33	Normal Nonane Config flags	Read/Write, live analysis configuration, see note 7)
0.34	Normal Decane Config flags	Read/Write, live analysis configuration, see note 7)
0.35	Oxygen Config flags	Read/Write, live analysis configuration, see note 7)
0.36	Carbon Monoxide Config flags	Read/Write, live analysis
0.37	Hydrogen Config flags	Read/Write, live analysis configuration, see note 7)
0.38	Argon Config flags	Read/Write, live analysis configuration, see note 7)
0.39	Number of live components	Read/Write
0.40	Get/release calc lock	Read/Write
0.41	Tube analysis stream index	Read/Write
0.42	Flow rate / volume scale flags	Read/Write, see note 8)
0.43	Aux contact 1 re-open interval	Read/Write
0.44	Aux contact 1 current state	Read Only
0.45	Aux contact 1 manual set	Read/Write
0.46	Aux contact 2 re-open interval	Read/Write
0.47	Aux contact 2 current state	Read Only
0.48	Aux contact 2 manual set	Read/Write

ARRAY.REGISTER	DESCRIPTION	USAGE
0.49	Remote Sense Action	Read/Write
0.50	Remote Sense State	Read Only
0.51	Events Available	Write, Canadian Event Log
0.52	Aux Contact 1 select bits low byte	Read/Write, see note 9)
0.53	Aux Contact 2 select bits low byte	Read/Write, see note 9)
0.54	Hold tube analog inputs	Read/Write
0.55	Static pressure absolute/gauge select	Read/Write, 0=absolute, 1=gauge
0.56	Programmable count before activating a2dfail	Read/Write
0.57	Current count of a2dfail in deadband	Read Only
0.58	Vol period complete flag	Read Only
0.59	Log period complete flag	Read Only
0.60	Day period complete flag	Read Only
0.61	Disable tube check-pointing	Read/Write 1=disable
0.62	Stop logging events from protocols for Canadian events	Read/Write 1=stop logging
0.63	Stop logging events for Canadian events	Read/Write 1=stop logging
0.64	Log gauge pressure	Read/Write 0=log absolute 1=log gage if gage transducer
0.65	Log Dp Check with pressure applied to Sp	Read Only
0.66	Stream source application	Read/Write
0.67	Enable/Disable Slip Second Adjustment	Read Only

A.10.1.1 Tube Byte Register Usage Notes

1) AGA-3 1985 Dynamic Factor Select Bits:

0x01, 1 /* Use Ftf */
 0x02, 2 /* Use Y */
 0x04, 4 /* Use Fr */
 0x08, 8 /* Use Fa */
 0x10, 16 /* Use Fpv */
 0x20, 32 /* Use Fw (water vapor factor) */
 0x40, 64 /* Use pipe tap equation */
 0x80, 128 /* tap cfg supported (Set by FCU) */

2) AGA-3 1992 Static Factor Select Bits:

0x08 /* Use Live CD if set */
 0x10 /* Use Fws (Faux:well stream) */
 0x20 /* Static Pressure Tap is Upstream */
 0x40 /* Supports switchable characteristics */

3) AGA-3 1992 Dynamic Factor Select Bits:

0x02, 2 /* Use Y */
 0x10, 16 /* Use Fpv */
 0x20, 32 /* Use Fw (water vapor factor) */

- 4) Volume Calculation Type: 0 = NONE, 1=AGA-3 1985, 2=AGA-3 1992.
 5) Super-Compressibility Method: 0=NX19 with FIXED FT AND FP VALUES, 1=NX19 AUTO, 2=NX19 GRAVITY CO2 & N2, 3=NX19 CO2 & N2 & C1, 11=AGA-8 Gross, 12=AGA-8 Detail
 6) Characteristics Type: This was used in "Totalflow old database" format. This does not apply to X-series, DB2 format.
 7) Live Analysis Configuration flags: 0=USE FIXED ANALYSIS, 1=USE LIVE ANALYSIS FROM AIU, 2=USE LIVE ANALYSIS FROM OTHER PROTOCOL, 16=USE FIXED ANALYSIS ON ERROR. USE FIXED ANALYSIS ON ERROR may be added to selections 1 or 2.
 8) Flow rate / Volume scale flags: 0=MCF for volumes, SCF/HR for flow rates; 1=MCF for volumes, MCF/DAY for flow rates; 2=MMCF for volume, MCF/HR for flow rates; 3=MMCF for volumes, MMCF/DAY for flow rates.
 9) Aux Contact 1 & 2 select bits low byte: 1=trip contact on low charger; 2=trip contact on Dp low; 4=trip contact on Dp high; 8=trip contact on Ap low; 16=trip contact on Ap high; 32=trip contact on remote sense; 64=auto re-open; 128=trip contact on volume set-point. These registers can also be set from 16-bit integer registers 1.10 and 1.11.

A.10.2 Tube 16-Bit Integer Registers

ARRAY.REGISTER	DESCRIPTION	USAGE
1.0	Primary Element Mask	Read Only, indicates primary element type, see note 1)
1.1	Calc Method Mask	Read Only, indicates calculation methods supported, see note 2)
1.2	Calc Units Mask	Read Only, not used
1.3	Report Units Mask	Read Only, not used
1.4	Super Comp Method Mask	Read Only, indicates super-compressibility methods that may be selected. See note 3)
1.5	Live Analysis Update Interval	Read/Write, live analysis updates are expected in this interval, expressed in seconds
1.6	Volume Calc period	Read/Write, seconds
1.7	Daily Record Capacity	Read/Write, number of daily records, change to this value deletes existing database and starts new database
1.8	Log Record Capacity	Read/Write, number of log period records, change to this value deletes existing database and starts new database

ARRAY.REGISTER	DESCRIPTION	USAGE
1.9	Event Record Capacity	Read/Write, number of event records, change to this value deletes existing database and starts new database
1.10	Aux Contact 1 Select Bits	Read/Write, control bits, see note 4)
1.11	Aux Contact 2 Select Bits	Read/Write, control bits, see note 4)
1.12	Return number of events available	Write, Canadian Event Log
1.13	Therms Stream Id	Read/WriteAnalysis Stream Id
1.14	Modbus address of analyzer	Read/Write
1.15	Therms use fixed or last good	Read/Write
1.16	Daily Record Sequence Number	Read Only
1.17	Log Record Sequence Number	Read Only
1.18	Event Record Sequence Number	Read Only
1.19	DP Status Flags	Read Only, see note 5)
1.20	AP Status Flags	Read Only, see note 6)
1.21	TF Status Flags	Read Only, see note 7)
1.22	PI Status Flags	Read Only, see note 8)
1.23	Ext Status Flags	Read Only, see note 9)

A.10.2.1 Tube 16-Bit Integer Register Usage Notes

- 1) Primary Element Mask: 1=Orifice Square Root
- 2) Calculation Method Mask: 2=AGA-3 1985, 4=AGA-3 1992; The sum of these values (6) indicates 2 and 4 are valid choices.
- 3) Super-Compressibility Method Mask: 1=NX19 with FIXED FT AND FP VALUES, 2=NX19 AUTO, 4=NX19 GRAVITY CO2 & N2, 8=NX19 CO2 & N2 & C1, 2048=AGA8 Gross, 4096=AGA8 Detail. The sum of these values (6159) indicates all of the choices listed above are valid.
- 4) Aux Contact Select Bits: 1=trip contact on low charger; 2=trip contact on Dp low; 4=trip contact on Dp high; 8=trip contact on Ap low; 16=trip contact on Ap high; 32=trip contact on Remote Sense; 64=auto re-open; 128=trip contact on volume set-point; 256=trip contact on tf low; 512=trip contact on tf high; 1024=trip contact on flow rate low; 2048=trip contact on flow rate high; 16384=reverse contact logic.
- 5) Dp Status Flags: 1=low limit exceeded; 2=high limit exceeded; 4=over-range; 8=zero flow; 16=back flow.
- 6) Ap Status Flags: 1=low limit exceeded; 2=high limit exceeded; 4=over-range; 8=zero flow; 32768=gauge pressure device.
- 7) Tf Status Flags: 1=low limit exceeded; 2=high limit exceeded; 4=over-range.
- 8) PI Status Flags: 1=low limit exceeded; 2=high limit exceeded; 8=zero flow.
- 9) Ext Status Flags: 1=low limit exceeded; 2=high limit exceeded; 8=zero flow.

A.10.3 Tube 32-Bit Integer Registers

ARRAY.REGISTER	DESCRIPTION	USAGE
2.0	Log period	Read/Write, seconds
2.1	Julian timestamp of most recent AIU download	Read/Write, see note 1)
2.2	Julian timestamp of most recent live component update (not AIU)	Read/Write, see note 1)
2.3	Julian timestamp of prev day period	Read Only, see note 1)
2.4	Total slip seconds since boot	Read Only
2.5	Julian timestamp of last slip seconds	Read Only
2.6	Thread loop time (ms)	Read Only
2.7	Thread Min loop time (ms)	Read Only
2.8	Thread Max loop time (ms)	Read Only

A.10.3.1 Tube 32-Bit Integer Register Notes

- 1) Julian time is number of seconds since midnight, 1/1/1970.

A.10.4 Tube Floating Point Registers

ARRAY.REGISTER	DESCRIPTION	USAGE
3.0	Current AP / cal checks	Read/Write, psi, see note 1)
3.1	AP High Limit	Read/Write, psi, see note 1)
3.2	AP Low Limit	Read/Write, psi, see note 1)
3.3	Current Temp	Deg F
3.4	Fixed Temp	Deg F
3.5	Temp High Limit	Deg F
3.6	Temp Low Limit	Deg F
3.7	Flow Rate High Limit	Read/Write, see note 2)
3.8	Flow Rate Low Limit	Read/Write, see note 2)
3.9	Null	Read Only
3.10	Null	Read Only
3.11	Fixed F(b) AGA-3 1985	Read/Write
3.12	Fixed Cd AGA-3 1992	Read/Write
3.13	Zba	Read/Write
3.14	Oriface coef of expansion	Read/Write, inches/Deg F
3.15	Pipe coef of expansion	Read/Write, inches/Deg F
3.16	Barometric Pressure	Read/Write, PSIA
3.17	F(t) for Fpv NX19	Read/Write
3.18	F(p) for Fpv NX19	Read/Write

ARRAY.REGISTER	DESCRIPTION	USAGE
3.19	Fixed Analysis BTU	Read/Write, BTU/SCF
3.20	Fixed Analysis Gravity	Read/Write
3.21	Fixed Analysis Nitrogen	Read/Write, mole %
3.22	Fixed Analysis Carbon Dioxide	Read/Write, mole %
3.23	Fixed Analysis Hydrogen Sulfide	Read/Write, mole %
3.24	Fixed Analysis Water	Read/Write, mole %
3.25	Fixed Analysis Helium	Read/Write, mole %
3.26	Fixed Analysis Methane	Read/Write, mole %
3.27	Fixed Analysis Ethane	Read/Write, mole %
3.28	Fixed Analysis Propane	Read/Write, mole %
3.29	Fixed Analysis Normal Butane	Read/Write, mole %
3.30	Fixed Analysis Iso-Butane	Read/Write, mole %
3.31	Fixed Analysis Normal Pentane	Read/Write, mole %
3.32	Fixed Analysis Iso-Pentane	Read/Write, mole %
3.33	Fixed Analysis Normal Hexane	Read/Write, mole %
3.34	Fixed Analysis Normal Heptane	Read/Write, mole %
3.35	Fixed Analysis Normal Octane	Read/Write, mole %
3.36	Fixed Analysis Normal Nonane	Read/Write, mole %
3.37	Fixed Analysis Normal Decane	Read/Write, mole %
3.38	Fixed Analysis Oxygen	Read/Write, mole %
3.39	Fixed Analysis Carbon Monoxide	Read/Write, mole %
3.40	Fixed Analysis Hydrogen	Read/Write, mole %
3.41	Fixed Analysis Argon	Read/Write, mole %
3.42	Fixed H2O Content	Read/Write, ppm
3.43	Fixed H2O Bias	Read/Write, ppm
3.44	Live Analysis Gravity Accumulator	Read/Write,
3.45	Live Analysis BTU Accumulator	Read/Write, BTU/SCF
3.46	Live Analysis Nitrogen Accumulator	Read/Write, mole %
3.47	Live Analysis Carbon Dioxide Accumulator	Read/Write, mole %
3.48	Live Analysis Hydrogen Sulfide Accumulator	Read/Write, mole %
3.49	Live Analysis Water Accumulator	Read/Write, mole %
3.50	Live Analysis Helium Accumulator	Read/Write, mole %
3.51	Live Analysis Methane Accumulator	Read/Write, mole %

ARRAY.REGISTER	DESCRIPTION	USAGE
3.52	Live Analysis Ethane Accumulator	Read/Write, mole %
3.53	Live Analysis Propane Accumulator	Read/Write, mole %
3.54	Live Analysis Normal Butane Accumulator	Read/Write, mole %
3.55	Live Analysis Iso-Butane Accumulator	Read/Write, mole %
3.56	Live Analysis Normal Pentane Accumulator	Read/Write, mole %
3.57	Live Analysis Iso-Pentane Accumulator	Read/Write, mole %
3.58	Live Analysis Normal Hexane Accumulator	Read/Write, mole %
3.59	Live Analysis Normal Heptane Accumulator	Read/Write, mole %
3.60	Live Analysis Normal Octane Accumulator	Read/Write, mole %
3.61	Live Analysis Normal Nonane Accumulator	Read/Write, mole %
3.62	Live Analysis Normal Decane Accumulator	Read/Write, mole %
3.63	Live Analysis Oxygen Accumulator	Read/Write, mole %
3.64	Live Analysis Carbon Monoxide Accumulator	Read/Write, mole %
3.65	Live Analysis Hydrogen Accumulator	Read/Write, mole %
3.66	Live Analysis Argon Accumulator	Read/Write, mole %
3.67	Log Site Code in Event Log	
3.68	Valve Control Accumulated Volume	Read/Write, MCF
3.69	Aux Contact 1 Volume Setpoint	Read/Write, MCF
3.70	Aux Contact 2 Volume Setpoint	Read/Write, MCF
3.71	current contract day accumulated energy	Read Only, MBTU
3.72	yesterdays contract day accumulated energy	Read Only, MBTU
3.73	Current Energy rate	Read Only MBTU/HR
3.74	Month Accum Volume	Read Only, MCF
3.75	Month Accum Volume, Not Reset by Reset Vol	Read Only, MCF
3.76	Month Accum Energy	Read Only, MMBTU
3.77	Month Accum Energy, Not Reset by Reset Vol	Read Only, MMBTU
3.78	Fixed AP value	Read/Write
3.79	Current SCF flow	Read Only
3.80	Previous Month Accumulated Volume	Read Only

ARRAY.REGISTER	DESCRIPTION	USAGE
3.81	Previous Month Accumulated Volume not affected by reset volume command	Read Only
3.82	Previous Month Energy	Read Only
3.83	Previous Month Energy not affected by reset volume command	Read Only

A.10.4.1 Tube Floating Point Register Notes

- 1) Static pressure values are in PSIA or PSIG depending on gauge pressure device selection. See Tube Byte Register 0.55.
- 2) Flow Rate Limits units depend on Flow rate / volume scale flags. See Tube Byte Register 0.42.

A.10.5 Tube Register Cross Reference

Tube register cross references are structures containing the register access values for data used by the tube but owned by another application. The following structure defines data type Register.

```
typedef struct {      // Register Struct
    byte app;         // Application
    byte array;       // Register array
    int16 index;      // index into array
} Register;
```

ARRAY.REGISTER	DESCRIPTION	USAGE
4.0	AP Register	Read/Write
4.1	DP Register	Read/Write
4.2	TF Register	Read/Write
4.3	PI Register	Read/Write
4.4	RS Register	Read/Write
4.5	AC 1 Register	Read/Write
4.6	AC 1 DI Register	Read/Write
4.7	AC 2 Register	Read/Write
4.8	AC 2 DI Register	Read/Write

A.10.6 Tube String Registers

ARRAY.REGISTER	DESCRIPTION	USAGE
5.0	Tube ID	Read/Write
5.1	Tube last analysis time	Read Only
5.2	Tube Description	Read/Write

A.10.7 Tube Last Calculation Period Analysis Registers, Floating Point

ARRAY.REGISTER	DESCRIPTION	USAGE
10.0	Last Calc Nitrogen	Read Only, mole %
10.1	Last Calc Carbon Dioxide	Read Only, mole %
10.2	Last Calc Hydrogen Sulfide	Read Only, mole %
10.3	Last Calc Water	Read Only, mole %
10.4	Last Calc Helium	Read Only, mole %
10.5	Last Calc Methane	Read Only, mole %
10.6	Last Calc Ethane	Read Only, mole %
10.7	Last Calc Propane	Read Only, mole %
10.8	Last Calc Normal Butane	Read Only, mole %
10.9	Last Calc Iso-Butane	Read Only, mole %
10.10	Last Calc Normal Pentane	Read Only, mole %
10.11	Last Calc Iso-Pentane	Read Only, mole %
10.12	Last Calc Normal Hexane	Read Only, mole %
10.13	Last Calc Normal Heptane	Read Only, mole %
10.14	Last Calc Normal Octane	Read Only, mole %
10.15	Last Calc Normal Nonane	Read Only, mole %
10.16	Last Calc Normal Decane	Read Only, mole %
10.17	Last Calc Oxygen	Read Only, mole %
10.18	Last Calc Carbon Monoxide	Read Only, mole %
10.19	Last Calc Hydrogen	Read Only, mole %
10.20	Last Calc Argon	Read Only, mole %
10.21	Last Calc Air	Read Only, mole %
10.22	Last Calc Heavy Hydrocarbons	Read Only, mole %
10.23	Last Calc Heat Content	Read Only, BTU/SCF
10.24	Last Calc Specific Gravity	Read Only

A.10.8 Tube Archive Registers – Read Only

The following registers access historical data records or record items. For all tube archive registers, register value 0 refers to the most recent record, 1 refers to the next most recent record and 2 refers to the next oldest record. The oldest record is referred to by register number MAX RECORDS – 1. For Log Period registers, register value 0 refers to the last logged record. For Day Period, register value 0 refers to the current contract day record.

A.10.9 Tube Log Period Registers

ARRAY	DESCRIPTION	USAGE
200	Log Period Static Pressure	Floating Point, PSIA

ARRAY	DESCRIPTION	USAGE
201	Log Period Diff. Pressure	Floating Point, Inches H2O
202	Log Period Temperature	Floating Point, Deg F
204	Log Period Extension	Floating Point
205	Log Period Volume	Floating Point, MCF
206	Log Period Heating Value	Floating Point, MMBTU
207	Log Period Flow time	Unsigned Long, seconds
208	Log Period Total time	Unsigned Long, seconds
209	Log Period Alarm bits	32 bits, see note 1)
250	Log Period Record	See note 2)

A.10.9.1 Tube Log Period Usage Notes

1) Log Period Alarm Bits -

0x00080000, 524288 - Flow rate high limit
 0x00040000, 262144 - Flow rate low limit
 0x00020000, 131072 - Temperature high limit
 0x00010000, 65536 - Temperature low limit
 0x00008000, 32768 - Static pressure high limit
 0x00004000, 16384 - Static pressure low limit
 0x00002000, 8192 - Dp high limit
 0x00001000, 4096 - Dp low limit
 0x00000800, 2048 - Zero flow
 0x00000400, 1024 - Back flow
 0x00000200, 512 - Remote sense (DI)
 0x00000100, 256 - contact out (DO)
 0x00000080, 128 - temperature channel A/D over-range
 0x00000040, 64 - static pressure channel A/D over-range
 0x00000020, 32 - differential pressure channel A/D over-range
 0x00000010, 16 - low charger
 0x00000008, 8 - low lithium battery
 0x00000004, 4 - AIU / analyzer data not received
 0x00000002, 2 - NX19 methane=1 / gravity=0 method
 0x00000001, 1 - calculation error

2) Log Period Record definition –

```

typedef struct
{
    unsigned long date; /* Julian Date / Time */
    unsigned int sn; /* Sequence Number */
    float dp; /* period avg DP */
    float ap; /* period avg AP */
    float tf; /* period avg TEMP */
    float ext; /* period EXTENSION */
    float vol; /* period VOLUME */
    float btu; /* period ENERGY */
    unsigned int ftime; /* period FLOWTIME */
    unsigned int ptime; /* period TIME */
    unsigned char aflags[3]; /* period ALARMS */
    unsigned char vcode; /* Verification Code */
} LOGRECORD;
  
```

A.10.10 Tube Daily Registers

ARRAY	DESCRIPTION	USAGE
220	Daily Static Pressure	Floating Point, PSIA
221	Daily Diff. Pressure	Floating Point, Inches H2O
222	Daily Temperature	Floating Point, Deg F
224	Daily Extension	Floating Point
225	Daily Volume	Floating Point, MCF
226	Daily Heating Value	Floating Point, MBTU
227	Daily Flow time	Unsigned Long, seconds
228	Daily Total time	Unsigned Long, seconds
229	Daily Alarm bits	32 bits, See note 1)
250	Log Period Archive Record	
251	Daily Record	See note 2)
252	Event Log	

A.10.10.1 Tube Daily Register Usage Notes

1) Daily Alarm Bits -

- 0x00080000, 524288 - Flow rate high limit
- 0x00040000, 262144 - Flow rate low limit
- 0x00020000, 131072 - Temperature high limit
- 0x00010000, 65536 - Temperature low limit
- 0x00008000, 32768 - Static pressure high limit
- 0x00004000, 16384 - Static pressure low limit
- 0x00002000, 8192 - Dp high limit
- 0x00001000, 4096 - Dp low limit
- 0x00000800, 2048 - Zero flow
- 0x00000400, 1024 - Back flow
- 0x00000200, 512 - Remote sense (DI)
- 0x00000100, 256 - contact out (DO)
- 0x00000080, 128 - temperature channel A/D over-range
- 0x00000040, 64 - static pressure channel A/D over-range
- 0x00000020, 32 - differential pressure channel A/D over-range
- 0x00000010, 16 - low charger
- 0x00000008, 8 - low lithium battery
- 0x00000004, 4 - AIU / analyzer data not received
- 0x00000002, 2 - NX19 methane=1 / gravity=0 method
- 0x00000001, 1 - calculation error

2) Daily Record definition –

```
typedef struct
{
    unsigned long date;           /* Julian Date / Time */
    unsigned int sn;             /* Sequence Number */
    unsigned int event;          /* Last Event Log Seq Num */
    unsigned int firstlog;       /* First Log Period Seq Num */
    unsigned int lastlog;        /* Last Log Period Seq Num */
    unsigned char c_hr;          /* Contract Hour */
}
```



```

float    ext;          /* Daily Extension */
float    vol;          /* Daily Volume */
float    btu;          /* Daily Energy */
unsigned long ftime;   /* Daily Flowtime */
unsigned long btime;   /* Daily Back-flowtime */
unsigned long ptime;   /* period TIME */
unsigned char aflags[3]; /* period ALARMS */
float    ap;           /* Daily Avg AP */
float    minap;        /* Daily Minimum AP */
float    maxap;        /* Daily Maximum AP */
float    aplpct;        /* Daily AP LO per cent */
float    aphpct;        /* Daily AP HI per cent */
float    dp;           /* Daily Avg DP */
float    mindp;        /* Daily Minimum DP */
float    maxdp;        /* Daily Maximum DP */
float    dplpct;        /* Daily DP LO per cent */
float    dphpct;        /* Daily DP HI per cent */
float    tf;           /* Daily Avg Temp */
float    mintf;        /* Daily Minimum TF */
float    maxtf;        /* Daily Maximum TF */
float    tflpct;        /* Daily DP LO per cent */
float    tfhpct;        /* Daily DP HI per cent */
unsigned char vcode;   /* Verification Code */

```

} DAYRECORD;

A.10.11 Tube Events Registers

ARRAY	DESCRIPTION	USAGE
252	Event Log Record	See note 1)

A.10.11.1 Tube Event Register Usage Notes

- 1) Tube Event Log Record definition –

```

typedef struct
{
    unsigned long date;      /* Julian Date/Time */
    unsigned char flags;     /* Event Flags */
    unsigned int sn;         /* Sequence Number */
    unsigned int code;       /* Event Code */
    unsigned char oldval[4]; /* Previous Value */
    unsigned char newval[4]; /* Current Value */
    unsigned char vcode;     /* Verification Code */
} EVTRECORD;

```

A.10.12 AGA-3 Tube Registers

The following register tables describe registers unique to AGA-3 measurement tubes.

ARRAY.REGISTER	DESCRIPTION	USAGE
6.0	1985 Static Factor Select Bits	Read/Write, See note 1)
6.1	Misc Select Bits	Read/Write, See note 2)
6.2	Vol - Flow Rate unit selection for volume	Read/Write, See note 3)

ARRAY.REGISTER	DESCRIPTION	USAGE
6.3	Vol - Flow Rate unit selection for flow rate	Read/Write, See note 4)
6.4	Auto Fb Calc	Read/Write, for AGA-3 1985
6.5	Log Dp Check with pressure applied to Sp	Read/Write

A.10.12.1 AGA-3 Byte Register Usage Notes

1) AGA-3 1985 Static Factor Select Bits –

- 0x01, 1 /* Use Fpb */
- 0x02, 2 /* Use Ftb */
- 0x04, 4 /* Use Fg */
- 0x08, 8 /* Use Fb */
- 0x10, 16 /* Use Fws (Faux:well stream) */
- 0x20, 32 /* Static Pressure Tap is Upstream */
- 0x40, 64 /* Supports switchable characteristics, this bit not writable*/

2) AGA-3 Misc Select Bits –

- 0x01, 1 /* RTD Installed */
- 0x02, 2 /* Use RTD in calcs */
- 0x04, 4 /* Reserved */
- 0x08, 8 /* Check Security Code */
- 0x10, 10 /* Orifice Plate type */
- 0x20, 20 /* Use Live Analyzer Data in volume calc */
- 0x40, 40 /* Use Fixed Ax data on analyzer error */
- 0x80, 80 /* reserved */

Vol - Flow Rate unit selection for volume

0 = MCF

1 = MMCF

3) Vol - Flow Rate unit selection for flow rate

0 = per hour,

if Vol - Flow Rate unit selection for volume = 0, rate will be SCF/HOUR;

if Vol - Flow Rate unit selection for volume = 1, rate will be MCF/HOUR.

1 = per day,

if Vol - Flow Rate unit selection for volume = 0, rate will be MCF/DAY;

if Vol - Flow Rate unit selection for volume = 1, rate will be MMCF/DAY.

A.10.13 AGA-3 Float Registers

ARRAY.REGISTER	DESCRIPTION	USAGE
7.0	Current DP / cal checks	Read/Write
7.1	DP High Limit	Read/Write
7.2	DP Low Limit	Read/Write
7.3	DP Zero CutOff	Read/Write
7.4	Current Flow Rate SCF/Hr	Read Only
7.5	Last Vol Period volume MCF	Read Only
7.6	Accumulated Volume MCF	Read Only

ARRAY.REGISTER	DESCRIPTION	USAGE
7.7	Today's contract day volume MCF	Read Only
7.8	Orifice diameter	Read/Write
7.9	Pipe diameter	Read/Write
7.10	Pressure base	Read/Write
7.11	Temperature base	Read/Write
7.12	Fixed F(aux)	Read/Write
7.13	Ratio of specific heats	Read/Write
7.14	Fluid viscosity	Read/Write
7.15	C-Prime	Read Only
7.16	Non-Flow weighted Accum AP	Read Only
7.17	Minute Flow Secs	Read Only
7.18	Yesterday's contract day volume SCF	Read Only
7.19	Current Flow Rate scaled per chkmcf	Read Only, See Note 1)
7.20	Last Vol Period volume scaled per chkmcf	Read Only, See Note 1)
7.21	Accumulated Volume scaled per chkmcf	Read Only, See Note 1)
7.22	Today's contract day volume scaled per chkmcf	Read Only, See Note 1)
7.23	Yesterday's contract day volume scaled per chkmcf	Read Only, See Note 1)
7.24	Flow Rate Hi limit scaled per chkmcf	Read Only, See Note 1)
7.25	Flow Rate Lo limit scaled per chkmcf	Read Only, See Note 1)
7.26	Last Calc Ap	Read Only
7.27	Last Calc Dp	Read Only
7.28	Last Calc Tf	Read Only
7.29	Last Calc Extension	Read Only
7.30	Last Calc Y Exp Factor	Read Only
7.31	Last Calc Fpv	Read Only
7.32	Last Calc Fw	Read Only
7.33	Last Calc Volumetric FlowRate (Qv) SCF/Hour	Read Only
7.34	Last Calc Hv BTU/SCF	Read Only
7.35	Last Calc Specific Gravity	Read Only
7.36	Last Calc FIP, AGA3-1992	Read Only
7.37	Last Calc Ev, AGA3-1992	Read Only
7.38	Last Calc Orifice diameter at Tf, Inches, AGA3-1992,	Read Only

ARRAY.REGISTER	DESCRIPTION	USAGE
7.39	Last Calc Pipe diameter at Tf, Inches, AGA3-1992	Read Only
7.40	Last Calc Base Density, lbsm/cf, AGA3-1992	Read Only
7.41	Last Calc Mass Flow Rate (qm), lbsm/hour, AGA3-1992	Read Only
7.42	Last Calc Coefficient of discharge (Cd), AGA3-1992	Read Only
7.43	Last Calc Reynolds Number Factor (Fr), AGA3-1985	Read Only
7.44	Last Calc Pressure Base Factor (Fpb), AGA3-1985	Read Only
7.45	Last Calc Temperature Base Factor (Ftb), AGA3-1985	Read Only
7.46	Last Calc Flowing Temperature Factor (Ftf), AGA3-1985	Read Only
7.47	Last Calc Specific Gravity Factor (Fg), AGA3-1985	Read Only
7.48	Last Calc Orifice Thermal Expansion Factor (Fa), AGA3-1985	Read Only
7.49	Last Calculate AGA3 1992 Zb	Read Only
7.50	Last Calculate AGA3 1992 Zf	Read Only
7.51	DP/ACF Percent High for Day	Read Only
7.52	DP/ACF Percent Low for Day	Read Only

A.10.13.1 AGA-3 Float Register Usage Notes

- 1) These vary based on Vol - Flow Rate unit selection. See 0.42.

A.10.14 AGA-3 String Registers

ARRAY.REGISTER	DESCRIPTION	USAGE
8.0	Rate Unit String	Note 1)
8.1	Volume Unit String starting at MCF	Note 1)
8.2	Volume Unit String starting at SCF	Note 1)

A.10.14.1 AGA-3 String Register Usage Notes

- 1) These vary based on Vol - Flow Rate unit selection. See 0.42.

A.10.15 AGA-3 Int32 Registers

ARRAY.REGISTER	DESCRIPTION	USAGE
9.0	Tube Current Alarm Bits	Read Only, See note 1)

1) Tube Alarm Bits -

- 0x00080000, 524288 - Flow rate high limit
- 0x00040000, 262144 - Flow rate low limit
- 0x00020000, 131072 - Temperature high limit
- 0x00010000, 65536 - Temperature low limit
- 0x00008000, 32768 - Static pressure high limit
- 0x00004000, 16384 - Static pressure low limit
- 0x00002000, 8192 - Dp high limit
- 0x00001000, 4096 - Dp low limit
- 0x00000800, 2048 - Zero flow
- 0x00000400, 1024 - Back flow
- 0x00000200, 512 - Remote sense (DI)
- 0x00000100, 256 - contact out (DO)
- 0x00000080, 128 - temperature channel A/D over-range
- 0x00000040, 64 - static pressure channel A/D over-range
- 0x00000020, 32 - differential pressure channel A/D over-range
- 0x00000010, 16 - low charger
- 0x00000008, 8 - low lithium battery
- 0x00000004, 4 - AIU / analyzer data not received
- 0x00000002, 2 - NX19 methane=1 / gravity=0 method
- 0x00000001, 1 - calculation error

A.11 AGA-7 Tube Application Registers

Tube measurement applications share several common data items. The items listed under this heading are common to all tube measurement applications. Usage and notes are specific to AGA-7 tube applications. Format for register list is array#.register# description. Application number depends on the order of application instantiation.

A.11.1 Tube Byte Registers

ARRAY.REGISTER	DESCRIPTION	USAGE
0.0	Contract Hour	Read/Write, 0-23
0.1	Reset Volume Command	Write
0.2	Reset Log Period Command	Write
0.3	Calibration Hold Mode	Read/Write
0.4	AP/ACF/TF Over Range Flags	Read Only
0.5	Tube Database Rev	Read Only
0.6	AGA-3 1985 Dynamic Select Bits	Read/Write, used only for AGA-3, 1985, other tubes or calculation methods ignore this value
0.7	AGA-3 1992 Static Select Bits	Read/Write, used only for AGA-3, 1992, other tubes or calculation methods ignore this value
0.8	AGA-3 1992 Dynamic Select Bits	Read/Write, used only for AGA-3, 1992, other tubes or calculation methods ignore this value
0.9	Volume Calc Type	Read/Write
0.10	Calc Units	Read Only

ARRAY.REGISTER	DESCRIPTION	USAGE
0.11	Report Units	Read Only
0.12	Super Compressibility Method	Read/Write, see note 1)
0.13	Use Square Root Average flag	Read/Write
0.14	Characteristic Record Type	Read/Write, see note 2)
0.15	Use Fixed H2O	Read/Write, for Fw calculation
0.16	Gravity Config flags	Read/Write, live analysis configuration, see note 3)
0.17	BTU Config flags	Read/Write, live analysis configuration, see note 3)
0.18	Nitrogen Config flags	Read/Write, live analysis configuration, see note 3)
0.19	Carbon Dioxide Config flags	Read/Write, live analysis configuration, see note 3)
0.20	Hydrogen Sulfide Config flags	Read/Write, live analysis configuration, see note 3)
0.21	Water Config flags	Read/Write, live analysis configuration, see note 3)
0.22	Helium Config flags	Read/Write, live analysis configuration, see note 3)
0.23	Methane Config flags	Read/Write, live analysis configuration, see note 3)
0.24	Ethane Config flags	Read/Write, live analysis configuration, see note 3)
0.25	Propane Config flags	Read/Write, live analysis configuration, see note 3)
0.26	Normal Butane Config flags	Read/Write, live analysis configuration, see note 3)
0.27	Iso-Butane Config flags	Read/Write, live analysis configuration, see note 3)
0.28	Normal Pentane Config flags	Read/Write, live analysis configuration, see note 3)
0.29	Iso-Pentane Config flags	Read/Write, live analysis configuration, see note 3)
0.30	Normal Hexane Config flags	Read/Write, live analysis configuration, see note 3)
0.31	Normal Heptane Config flags	Read/Write, live analysis configuration, see note 3)
0.32	Normal Octane Config flags	Read/Write, live analysis configuration, see note 3)
0.33	Normal Nonane Config flags	Read/Write, live analysis configuration, see note 3)

ARRAY.REGISTER	DESCRIPTION	USAGE
0.34	Normal Decane Config flags	Read/Write, live analysis configuration, see note 3)
0.35	Oxygen Config flags	Read/Write, live analysis configuration, see note 3)
0.36	Carbon Monoxide Config flags	Read/Write, live analysis configuration, see note 3)
0.37	Hydrogen Config flags	Read/Write, live analysis configuration, see note 3)
0.38	Argon Config flags	Read/Write, live analysis configuration, see note 3)
0.39	Number of live components	Read/Write
0.40	Get/release calc lock	Read/Write
0.41	Tube analysis stream index	Read/Write
0.42	Flow rate / volume scale flags	Read/Write, see note 4)
0.43	Aux contact 1 re-open interval	Read/Write
0.44	Aux contact 1 current state	Read Only
0.45	Aux contact 1 manual set	Read/Write
0.46	Aux contact 2 re-open interval	Read/Write
0.47	Aux contact 2 current state	Read Only
0.48	Aux contact 2 manual set	Read/Write
0.49	Remote Sense Action	Read/Write
0.50	Remote Sense State	Read Only
0.51	Events Available	Write, Canadian Event Log
0.52	Aux Contact 1 select bits low byte	Read/Write, see note 5)
0.53	Aux Contact 2 select bits low byte	Read/Write, see note 5)
0.54	Hold tube analog inputs	Read/Write
0.55	Static pressure absolute/gauge select	Read/Write, 0=absolute, 1=gauge
0.56	Programmable count before activating a2dfail	Read/Write
0.57	Current count of a2dfail in deadband	Read Only
0.58	Vol period complete flag	Read Only
0.59	Log period complete flag	Read Only
0.60	Day period complete flag	Read Only
0.61	Disable tube check-pointing	Read/Write 1=disable
0.62	Stop logging events from protocols for Canadian events	Read/Write 1=stop logging

ARRAY.REGISTER	DESCRIPTION	USAGE
0.63	Stop logging events for Canadian events	Read/Write 1=stop logging
0.64	Log gage pressure	Read/Write 0=log absolute 1=log gage if gage transducer
0.65	Log Dp Check with pressure applied to Sp	Read/Write 1=stop logging
0.66	Stream source application	Read/Write
0.67	Enable/Disable Slip Second Adjustment	Read Only

A.11.1.1 Tube Byte Register Usage Notes

- 1) Super-Compressibility Method: 0=NX19 with FIXED FT AND FP VALUES, 1=NX19 AUTO, 2=NX19 GRAVITY CO2 & N2, 3=NX19 CO2 & N2 & C1, 11=AGA-8 Gross, 12=AGA-8 Detail
- 2) Characteristics Type: This was used in "Totalflow old database" format. This does not apply to X-series, DB2 format.
- 3) Live Analysis Configuration flags: 0=USE FIXED ANALYSIS, 1=USE LIVE ANALYSIS FROM AIU, 2=USE LIVE ANALYSIS FROM OTHER PROTOCOL, 16=USE FIXED ANALYSIS ON ERROR. USE FIXED ANALYSIS ON ERROR may be added to selections 1 or 2.
- 4) Flow rate / Volume scale flags: bit encoded flags –
- 5) Bits 0-1 rates times
- 6) 0 = /hour, 1 = /day, 2 = N/A, 3 = N/A
- 7) Bits 2-4 corrected volume, rate quantity units
- 8) 0 = scf, 4 = dscf, 8 = cscf, 12 = mscf
- 9) 16 = dm scf, 20 = cm scf, 28 = mm scf
- 10) Bits 5-7 uncorrected volume, rate quantity units
- 11) 0 = acf, 32 = dacf, 64 = cacf, 96 = macf,
- 12) 128 = dma cf, 160 = cma cf, 224 = mma cf
- 13) 5) Aux Contact 1 & 2 select bits low byte: 1=trip contact on low charger; 2=trip contact on ACF low; 4=trip contact on ACF high; 8=trip contact on Ap low; 16=trip contact on Ap high; 32=trip contact on remote sense; 64=auto re-open; 128=trip contact on volume set-point. These registers can also be set from 16-bit integer registers 1.10 and 1.11.

A.11.2 Tube 16-Bit Integer Registers

ARRAY.REGISTER	DESCRIPTION	USAGE
1.0	Primary Element Mask	Read Only, indicates primary element type, see note 1)
1.1	Calc Method Mask	Read Only, indicates calculation methods supported, see note 2)
1.2	Calc Units Mask	Read Only, not used
1.3	Report Units Mask	Read Only, not used
1.4	Super Comp Method Mask	Read Only, indicates super-compressibility methods that may be selected. See note 3)

ARRAY.REGISTER	DESCRIPTION	USAGE
1.5	Live Analysis Update Interval	Read/Write, live analysis updates are expected in this interval, expressed in seconds
1.6	Volume Calc period	Read/Write, seconds
1.7	Daily Record Capacity	Read/Write, number of daily records, change to this value deletes existing database and starts new database
1.8	Log Record Capacity	Read/Write, number of log period records, change to this value deletes existing database and starts new database
1.9	Event Record Capacity	Read/Write, number of event records, change to this value deletes existing database and starts new database
1.10	Aux Contact 1 Select Bits	Read/Write, control bits, see note 4)
1.11	Aux Contact 2 Select Bits	Read/Write, control bits, see note 4)
1.12	Return number of events available	Write, Canadian Event Log
1.13	Therms Stream Id	Read/Write Analysis Stream Id
1.14	Modbus address of analyzer	Read/Write
1.15	Therms use fixed or last good	Read/Write
1.16	Daily Record Sequence Number	Read Only
1.17	Log Record Sequence Number	Read Only
1.18	Event Record Sequence Number	Read Only
1.19	ACF Status Flags	Read Only, see note 5)
1.20	AP Status Flags	Read Only, see note 6)
1.21	TF Status Flags	Read Only, see note 7)
1.22	PI Status Flags	Read Only, see note 8)
1.23	Ext Status Flags	Read Only, see note 9)

A.11.2.1 Tube 16-Bit Integer Register Usage Notes

- 1) Primary Element Mask: 1=Orifice Square Root
- 2) Calculation Method Mask: 2=AGA-3 1985, 4=AGA-3 1992; The sum of these values (6) indicates 2 and 4 are valid choices.
- 3) Super-Compressibility Method Mask: 1=NX19 with FIXED FT AND FP VALUES, 2=NX19 AUTO, 4=NX19 GRAVITY CO2 & N2, 8=NX19 CO2 & N2 & C1, 2048=AGA8 Gross, 4096=AGA8 Detail. The sum of these values (6159) indicates all of the choices listed above are valid.
- 4) Aux Contact Select Bits: 1=trip contact on low charger; 2=trip contact on Acf low; 4=trip contact on Acf high; 8=trip contact on Ap low; 16=trip contact on Ap high; 32=trip contact on Remote Sense; 64=auto re-open; 128=trip contact on volume set-point; 256=trip contact on tf low;

512=trip contact on tf high; 1024=trip contact on flow rate low; 2048=trip contact on flow rate high; 16384=reverse contact logic.

- 5) Acf Status Flags: 1=low limit exceeded; 2=high limit exceeded; 4=N/A; 8=zero flow; 16=N/A.
- 6) Ap Status Flags: 1=low limit exceeded; 2=high limit exceeded; 4=over-range; 8=zero flow; 32768=gauge pressure device.
- 7) Tf Status Flags: 1=low limit exceeded; 2=high limit exceeded; 4=over-range.
- 8) PI Status Flags: 1=low limit exceeded; 2=high limit exceeded; 8=zero flow.
- 9) Ext Status Flags: 1=low limit exceeded; 2=high limit exceeded; 8=zero flow.

A.11.3 Tube 32-Bit Integer Registers

ARRAY.REGISTER	DESCRIPTION	USAGE
2.0	Log period	Read/Write, seconds
2.1	Julian timestamp of most recent AIU download	Read/Write, see note 1)
2.2	Julian timestamp of most recent live component update (not aiu)	Read/Write, see note 1)
2.3	Julian timestamp of prev day period	Read Only, see note 1)
2.4	Total slip seconds since boot	Read Only
2.5	Julian timestamp of last slip seconds	Read Only
2.6	Thread loop time (ms)	Read Only
2.7	Thread Min loop time (ms)	Read Only
2.8	Thread Max loop time (ms)	Read Only

A.11.3.1 Tube 32-Bit Integer Register Notes

- 1) Julian time is number of seconds since midnight, 1/1/1970.

A.11.4 Tube Floating Point Registers

ARRAY.REGISTER	DESCRIPTION	USAGE
3.0	Current AP / cal checks	Read/Write, psi, see note 1
3.1	AP High Limit	Read/Write, psi, see note 1
3.2	AP Low Limit	Read/Write, psi, see note 1
3.3	Current Temp	Deg F
3.4	Fixed Temp	Deg F
3.5	Temp High Limit	Deg F
3.6	Temp Low Limit	Deg F
3.7	Flow Rate High Limit	Read/Write, see note 2
3.8	Flow Rate Low Limit	Read/Write, see note 2
3.9	DP/ACF Percent High for Day	Read Only
3.10	DP/ACF Percent Low for Day	Read Only
3.11	Fixed F(b) AGA-3 1985	Read/Write

ARRAY.REGISTER	DESCRIPTION	USAGE
3.12	Fixed Cd AGA-3 1992	Read/Write
3.13	Zba	Read/Write
3.14	Oriface coef of expansion	Read/Write, inches/Deg F
3.15	Pipe coef of expansion	Read/Write, inches/Deg F
3.16	Barometric Pressure	Read/Write, PSIA
3.17	F(t) for Fpv NX19	Read/Write
3.18	F(p) for Fpv NX19	Read/Write
3.19	Fixed Analysis BTU	Read/Write, BTU/SCF
3.20	Fixed Analysis Gravity	Read/Write
3.21	Fixed Analysis Nitrogen	Read/Write, mole %
3.22	Fixed Analysis Carbon Dioxide	Read/Write, mole %
3.23	Fixed Analysis Hydrogen Sulfide	Read/Write, mole %
3.24	Fixed Analysis Water	Read/Write, mole %
3.25	Fixed Analysis Helium	Read/Write, mole %
3.26	Fixed Analysis Methane	Read/Write, mole %
3.27	Fixed Analysis Ethane	Read/Write, mole %
3.28	Fixed Analysis Propane	Read/Write, mole %
3.29	Fixed Analysis Normal Butane	Read/Write, mole %
3.30	Fixed Analysis Iso-Butane	Read/Write, mole %
3.31	Fixed Analysis Normal Pentane	Read/Write, mole %
3.32	Fixed Analysis Iso-Pentane	Read/Write, mole %
3.33	Fixed Analysis Normal Hexane	Read/Write, mole %
3.34	Fixed Analysis Normal Heptane	Read/Write, mole %
3.35	Fixed Analysis Normal Octane	Read/Write, mole %
3.36	Fixed Analysis Normal Nonane	Read/Write, mole %
3.37	Fixed Analysis Normal Decane	Read/Write, mole %
3.38	Fixed Analysis Oxygen	Read/Write, mole %
3.39	Fixed Analysis Carbon Monoxide	Read/Write, mole %
3.40	Fixed Analysis Hydrogen	Read/Write, mole %
3.41	Fixed Analysis Argon	Read/Write, mole %
3.42	Fixed H2O Content	Read/Write, ppm
3.43	Fixed H2O Bias	Read/Write, ppm
3.44	Live Analysis Gravity Accumulator	Read/Write,
3.45	Live Analysis BTU Accumulator	Read/Write, BTU/SCF

ARRAY.REGISTER	DESCRIPTION	USAGE
3.46	Live Analysis Nitrogen Accumulator	Read/Write, mole %
3.47	Live Analysis Carbon Dioxide Accumulator	Read/Write, mole %
3.48	Live Analysis Hydrogen Sulfide Accumulator	Read/Write, mole %
3.49	Live Analysis Water Accumulator	Read/Write, mole %
3.50	Live Analysis Helium Accumulator	Read/Write, mole %
3.51	Live Analysis Methane Accumulator	Read/Write, mole %
3.52	Live Analysis Ethane Accumulator	Read/Write, mole %
3.53	Live Analysis Propane Accumulator	Read/Write, mole %
3.54	Live Analysis Normal Butane Accumulator	Read/Write, mole %
3.55	Live Analysis Iso-Butane Accumulator	Read/Write, mole %
3.56	Live Analysis Normal Pentane Accumulator	Read/Write, mole %
3.57	Live Analysis Iso-Pentane Accumulator	Read/Write, mole %
3.58	Live Analysis Normal Hexane Accumulator	Read/Write, mole %
3.59	Live Analysis Normal Heptane Accumulator	Read/Write, mole %
3.60	Live Analysis Normal Octane Accumulator	Read/Write, mole %
3.61	Live Analysis Normal Nonane Accumulator	Read/Write, mole %
3.62	Live Analysis Normal Decane Accumulator	Read/Write, mole %
3.63	Live Analysis Oxygen Accumulator	Read/Write, mole %
3.64	Live Analysis Carbon Monoxide Accumulator	Read/Write, mole %
3.65	Live Analysis Hydrogen Accumulator	Read/Write, mole %
3.66	Live Analysis Argon Accumulator	Read/Write, mole %
3.67	Log Site Code in Event Log	
3.68	Valve Control Accumulated Volume	Read/Write, MCF
3.69	Aux Contact 1 Volume Setpoint	Read/Write, MCF
3.70	Aux Contact 2 Volume Setpoint	Read/Write, MCF
3.71	current contract day accumulated energy	Read Only, MBTU
3.72	yesterdays contract day accumulated energy	Read Only, MBTU
3.73	Current Energy rate	Read Only MBTU/HR

ARRAY.REGISTER	DESCRIPTION	USAGE
3.74	Month Accum Volume	Read Only, MCF
3.75	Month Accum Volume, Not Reset by Reset Vol	Read Only, MCF
3.76	Month Accum Energy	Read Only, MMBTU
3.77	Month Accum Energy, Not Reset by Reset Vol	Read Only, MMBTU
3.78	Fixed AP value	Read/Write
3.79	Current SCF flow	Read Only
3.80	Previous Month Accumulated Volume	Read Only
3.81	Previous Month Accumulated Volume not affected by reset volume command	Read Only
3.82	Previous Month Energy	Read Only
3.83	Previous Month Energy not affected by reset volume command	Read Only

A.11.4.1 Tube Floating Point Register Notes

- 1) Static pressure values are in PSIA or PSIG depending on gauge pressure device selection. See Tube Byte Register 0.55.
- 2) Flow Rate Limits units depend on Flow rate / volume scale flags. See Tube Byte Register 0.42.

A.11.5 Tube Register Cross Reference

Tube register cross references are structures containing the register access values for data used by the tube but owned by another application. The following structure defines data type Register.

```
typedef struct {      // Register Struct
    byte app;         // Application
    byte array;       // Register array
    int16 index;      // index into array
} Register;
```

ARRAY.REGISTER	DESCRIPTION	USAGE
4.0	AP Register	Read/Write
4.1	ACF Register	Read/Write
4.2	TF Register	Read/Write
4.3	PI Register	Read/Write
4.4	RS Register	Read/Write
4.5	AC 1 Register	Read/Write
4.6	AC 1 DI Register	Read/Write
4.7	AC 2 Register	Read/Write
4.8	AC 2 DI Register	Read/Write

A.11.6 Tube String Registers

ARRAY.REGISTER	DESCRIPTION	USAGE
5.0	Tube ID	Read/Write
5.1	Tube last analysis time	Read Only
5.2	Tube Description	Read/Write

A.11.7 Tube Last Calculation Period Analysis Registers, Floating Point

ARRAY.REGISTER	DESCRIPTION	USAGE
10.0	Last Calc Nitrogen	Read Only, mole %
10.1	Last Calc Carbon Dioxide	Read Only, mole %
10.2	Last Calc Hydrogen Sulfide	Read Only, mole %
10.3	Last Calc Water	Read Only, mole %
10.4	Last Calc Helium	Read Only, mole %
10.5	Last Calc Methane	Read Only, mole %
10.6	Last Calc Ethane	Read Only, mole %
10.7	Last Calc Propane	Read Only, mole %
10.8	Last Calc Normal Butane	Read Only, mole %
10.9	Last Calc Iso-Butane	Read Only, mole %
10.10	Last Calc Normal Pentane	Read Only, mole %
10.11	Last Calc Iso-Pentane	Read Only, mole %
10.12	Last Calc Normal Hexane	Read Only, mole %
10.13	Last Calc Normal Heptane	Read Only, mole %
10.14	Last Calc Normal Octane	Read Only, mole %
10.15	Last Calc Normal Nonane	Read Only, mole %
10.16	Last Calc Normal Decane	Read Only, mole %
10.17	Last Calc Oxygen	Read Only, mole %
10.18	Last Calc Carbon Monoxide	Read Only, mole %
10.19	Last Calc Hydrogen	Read Only, mole %
10.20	Last Calc Argon	Read Only, mole %
10.21	Last Calc Air	Read Only, mole %
10.22	Last Calc Heavy Hydrocarbons	Read Only, mole %
10.23	Last Calc Heat Content	Read Only, BTU/SCF
10.24	Last Calc Specific Gravity	Read Only

A.11.8 Tube Archive Registers, Read Only

The following registers access historical data records or record items. For all tube archive registers, register value 0 refers to the most recent record, 1 refers to the

next most recent record, 2 refers to the next oldest record. The oldest record is referred to by register number MAX RECORDS – 1.

A.11.8.1 Tube Log Period Registers

ARRAY	DESCRIPTION	USAGE
200	Log Period Static Pressure	Floating Point, PSIA
201	Log Period Diff. Pressure	Floating Point, Inches H2O
202	Log Period Temperature	Floating Point, Deg F
204	Log Period Extension	Floating Point
205	Log Period Volume	Floating Point, MCF
206	Log Period Heating Value	Floating Point, MMBTU
207	Log Period Flow time	Unsigned Long, seconds
208	Log Period Total time	Unsigned Long, seconds
209	Log Period Alarm bits	32 bits, see note 1)
250	Log Period Record	See note 2)

A.11.8.2 Tube Log Period Usage Notes

1) Log Period Alarm Bits -

- 0x00080000, 524288 - Flow rate high limit
- 0x00040000, 262144 - Flow rate low limit
- 0x00020000, 131072 - Temperature high limit
- 0x00010000, 65536 - Temperature low limit
- 0x00008000, 32768 - Static pressure high limit
- 0x00004000, 16384 - Static pressure low limit
- 0x00002000, 8192 - Acf high limit
- 0x00001000, 4096 - Acf low limit
- 0x00000800, 2048 - Zero flow
- 0x00000400, 1024 - Back flow
- 0x00000200, 512 - Remote sense (DI)
- 0x00000100, 256 - contact out (DO)
- 0x00000080, 128 - temperature channel A/D over-range
- 0x00000040, 64 - static pressure channel A/D over-range
- 0x00000020, 32 - differential pressure channel A/D over-range
- 0x00000010, 16 - low charger
- 0x00000008, 8 - low lithium battery
- 0x00000004, 4 - AIU / analyzer data not received
- 0x00000002, 2 - NX19 methane=1 / gravity=0 method
- 0x00000001, 1 - calculation error

2) 2) Log Period Record definition –

```
typedef struct
{
    unsigned long date;    /* Julian Date / Time */
    unsigned int sn;      /* Sequence Number */
    float    Acf;         /* period avg ACF */
    float    ap;          /* period avg AP */
    float    tf;          /* period avg TEMP */
    float    ext;         /* period EXTENSION */
    float    vol;         /* period VOLUME */
}
```

```

float      btu;                /* period ENERGY */
unsigned int ftime;           /* period FLOWTIME */
unsigned int ptime;          /* period TIME */
unsigned char aflags[3];     /* period ALARMS */
unsigned char vcode;        /* Verification Code */
} LOGRECORD;

```

A.11.9 Tube Daily Registers

ARRAY	DESCRIPTION	USAGE
220	Daily Static Pressure	Floating Point, PSIA
221	Daily Diff. Pressure	Floating Point, Inches H2O
222	Daily Temperature	Floating Point, Deg F
224	Daily Extension	Floating Point
225	Daily Volume	Floating Point, MCF
226	Daily Heating Value	Floating Point, MBTU
227	Daily Flow time	Unsigned Long, seconds
228	Daily Total time	Unsigned Long, seconds
229	Daily Alarm bits	32 bits, See note 1)
251	Daily Record	See note 2)

A.11.9.1 Tube Daily Register Usage Notes

1) Daily Alarm Bits -

0x00080000, 524288	- Flow rate high limit
0x00040000, 262144	- Flow rate low limit
0x00020000, 131072	- Temperature high limit
0x00010000, 65536	- Temperature low limit
0x00008000, 32768	- Static pressure high limit
0x00004000, 16384	- Static pressure low limit
0x00002000, 8192	- Acf high limit
0x00001000, 4096	- Acf low limit
0x00000800, 2048	- Zero flow
0x00000400, 1024	- Back flow
0x00000200, 512	- Remote sense (DI)
0x00000100, 256	- contact out (DO)
0x00000080, 128	- temperature channel A/D over-range
0x00000040, 64	- static pressure channel A/D over-range
0x00000020, 32	- differential pressure channel A/D over-range
0x00000010, 16	- low charger
0x00000008, 8	- low lithium battery
0x00000004, 4	- AIU / analyzer data not received
0x00000002, 2	- NX19 methane=1 / gravity=0 method
0x00000001, 1	- calculation error

2) Daily Record definition –

```

typedef struct
{
    unsigned long date;          /* Julian Date / Time */
    unsigned int sn;           /* Sequence Number */
}

```



```

unsigned int event;      /* Last Event Log Seq Num */
unsigned int firstlog;   /* First Log Period Seq Num */
unsigned int lastlog;   /* Last Log Period Seq Num */
unsigned char c_hr;     /* Contract Hour */
float ext;              /* Daily Extension */
float vol;              /* Daily Volume */
float btu;              /* Daily Energy */
unsigned long ftime;    /* Daily Flowtime */
unsigned long btime;    /* Daily Back-flowtime – 0 for AGA-7 */
unsigned long ptime;    /* period TIME */
unsigned char aflags[3]; /* period ALARMS */
float ap;               /* Daily Avg AP */
float minap;            /* Daily Minimum AP */
float maxap;            /* Daily Maximum AP */
float aplpct;           /* Daily AP LO per cent */
float aphpct;           /* Daily AP HI per cent */
float Acf;              /* Daily Avg ACF */
float minAcf;           /* Daily Minimum ACF */
float maxAcf;           /* Daily Maximum ACF */
float Acflpct;          /* Daily ACF LO per cent */
float Acfhpct;          /* Daily ACF HI per cent */
float tf;               /* Daily Avg Temp */
float mintf;            /* Daily Minimum TF */
float maxtf;            /* Daily Maximum TF */
float tflpct;           /* Daily ACF LO per cent */
float tfhpct;           /* Daily ACF HI per cent */
unsigned char vcode;    /* Verification Code */

```

} DAYRECORD;

A.11.10 Tube Event Registers

ARRAY	DESCRIPTION	USAGE
252	Event Log Record	See note 1)

A.11.10.1 Tube Event Registers Usage Notes

- 1) Tube Event Log Record definition –

```

typedef struct
{
  unsigned long date;      /* Julian Date/Time */
  unsigned char flags;     /* Event Flags */
  unsigned int sn;        /* Sequence Number */
  unsigned int code;      /* Event Code */
  unsigned char oldval[4]; /* Previous Value */
  unsigned char newval[4]; /* Current Value */
  unsigned char vcode;    /* Verification Code */
} EVTRECORD;

```

A.11.11 AGA-7 Tube Byte Registers

The following register tables describe registers unique to AGA-7 measurement tubes.

ARRAY.REGISTER	DESCRIPTION	USAGE
6.0	AGA-7 Factor Select Bits	Read/Write, See note 1)

ARRAY.REGISTER	DESCRIPTION	USAGE
6.1	Misc Select Bits	Read/Write, See note 2)
6.2	Units scale selection for uncorrected vol units	Read/Write, See note 3)
6.3	Units scale selection for corrected volume units	Read/Write, See note 4)
6.4	Units scale selection for flow rate units	Read/Write, See note 5)
6.5	AGA7 test Calculations	Write
6.6	Meter factor units, vol/pulse, pulses/vol	Read/Write

A.11.11.1 AGA-7 Byte Register Usage Notes

- 1) AGA-7 Factor Select Bits –
 - 0x01, 1 /* Use Fp */
 - 0x02, 2 /* Use Ft */
 - 0x04, 4 /* Use s */
 - 0x08, 8 /* Use Faux */
 - 0x40, 64 /* Supports switchable characteristics, this bit not writable*/
- 2) Misc Select Bits –
 - 0x01, 1 /* RTD Installed */
 - 0x02, 2 /* Use RTD in calcs */
 - 0x04, 4 /* reserved */
 - 0x08, 8 /* Check security code*/
 - 0x10, 16 /* use live ap in calcs */
 - 0x20, 32 /* Use live analyzer data in volume calc */
 - 0x40, 64 /* Use fixed analysis data on analyzer error */
 - 0x80, 128 /* reserved */
- 3) Units scale selection for uncorrected volume -
 - 0=ACF
 - 1=DACF
 - 2=CACF
 - 3=MACF
 - 4=DMACF
 - 5=CMACF
 - 6=MMACF
- 4) Units scale selection for corrected volume –
 - 0=SCF
 - 1=DSCF
 - 2=CSCF
 - 3=MSCF
 - 4=DMSCF
 - 5=CMSCF
 - 6=MMSCF
- 5) Units scale selection for flow rate –
 - 0 = /hour
 - 1 = /day

2 = /flow window period

6) Meter factor units

0=Vol/Pulses

1=Pulses/Vol

A.11.12 AGA-7 Float Registers

ARRAY.REGISTER	DESCRIPTION	USAGE
7.0	Current pulse counts	Read Only
7.1	ACF High Limit	Read/Write, units scaled per Units scale selection, see 0.42
7.2	ACF Low Limit	Read/Write, units scaled per Units scale selection, see 0.42
7.3	K-factor	Read/Write
7.4	Flow window	Read/Write, seconds
7.5	Fixed static pressure value	Read/Write, PSIA or PSIG
7.6	Current corrected flow rate	Read Only, units scaled per Units scale selection, see 0.42
7.7	Today's contract day corrected volume	Read Only, units scaled per Units scale selection, see 6.3
7.8	Accumulated corrected volume	Read Only, units scaled per Units scale selection, see 6.3
7.9	Yesterday's corrected volume	Read Only, units scaled per Units scale selection, see 6.3
7.10	Current uncorrected flow rate	Read Only, units scaled per Units scale selection, see 6.2
7.11	Today's contract day uncorrected volume	Read Only, units scaled per Units scale selection, see 0.42
7.12	Accumulated uncorrected volume	Read Only, units scaled per Units scale selection, see 6.2
7.13	Yesterday's uncorrected volume	Read Only, units scaled per Units scale selection, see 6.2
7.14	Accumulated uncorrected volume	Read Only, units scaled per Units scale selection, see 6.2
7.15	Pressure base	Read/Write, PSIA
7.16	Temperature base	Read/Write, Degrees F
7.17	Fixed F(aux)	Read/Write
7.18	C-prime test value	Read Only
7.19	Last calculated C-prime	Read Only
7.20	Last flow period actual volume	Read Only, ACF
7.21	Last flow period average Ap regardless of flow	Read Only, PSIA

ARRAY.REGISTER	DESCRIPTION	USAGE
7.22	Last flow period flow seconds	Read Only, seconds
7.23	Current flow rate	Read Only, SCF/Hour
7.24	Current contract day corrected volume	Read Only, SCF
7.25	Accumulated corrected volume	Read Only, SCF
7.26	Yesterday's corrected volume	Read Only, SCF
7.27	Current uncorrected flow rate	Read Only, ACF/Hour
7.28	Current contract day uncorrected volume	Read Only, ACF
7.29	Accumulated uncorrected volume	Read Only, ACF
7.30	Yesterday's uncorrected volume	Read Only, ACF
7.31	Corrected flow rate high limit	Read/Write, scaled per Units scale selection, see 6.4
7.32	Corrected flow rate low limit	Read/Write, scaled per Units scale selection, see 6.4
7.33	Last calculated corrected volume	Read Only, units scaled per Units scale selection, see 6.3
7.34	Last calculated uncorrected volume	Read Only, units scaled per Units scale selection, see 6.2
7.35	Last flow period pulse counts	Read Only, counts
7.36	Last Calc Ap, PSIA	Read Only
7.37	Last Calc Tf, Deg F	Read Only
7.38	Last Calc actual volume, ACF	Read Only
7.39	Last Calc Fpv	Read Only
7.40	Last Calc Pressure Correction Factor (Fps)	Read Only
7.41	Last Calc Temperature Correction Factor (Fts)	Read Only
7.42	Last Calc heating value, BTU/SCF	Read Only
7.43	Last Calc Specific Gravity	Read Only
7.44	DP/ACF Percent High for Day	Read Only
7.45	DP/ACF Percent Low for Day	Read Only

A.11.13 AGA-7 String Registers

ARRAY.REGISTER	DESCRIPTION	USAGE
8.0	Corrected Rate Units String	Note 1)
8.1	Corrected Volume Units String	Note 1)
8.2	Uncorrected Rate Units String	Note 1)
8.3	Uncorrected Volume Units String	

A.11.13.1 Aga-7 String Register Usage Notes

- 1) These strings vary per Units scale selection. See 6.2, 6.3, and 6.4.

A.11.14 AGA-7 Int32 Registers

ARRAY.REGISTER	DESCRIPTION	USAGE
9.0	Tube Current Alarm Bits	Read Only, See note 1)

A.11.14.1 AGA-7 Int32 Register Usage Notes

- 1) Tube Alarm Bits -
- | | |
|--------------------|--|
| 0x00080000, 524288 | - Flow rate high limit |
| 0x00040000, 262144 | - Flow rate low limit |
| 0x00020000, 131072 | - Temperature high limit |
| 0x00010000, 65536 | - Temperature low limit |
| 0x00008000, 32768 | - Static pressure high limit |
| 0x00004000, 16384 | - Static pressure low limit |
| 0x00002000, 8192 | - Acf high limit |
| 0x00001000, 4096 | - Acf low limit |
| 0x00000800, 2048 | - Zero flow |
| 0x00000400, 1024 | - Back flow |
| 0x00000200, 512 | - Remote sense (DI) |
| 0x00000100, 256 | - contact out (DO) |
| 0x00000080, 128 | - temperature channel A/D over-range |
| 0x00000040, 64 | - static pressure channel A/D over-range |
| 0x00000020, 32 | - differential pressure channel A/D over-range |
| 0x00000010, 16 | - low charger |
| 0x00000008, 8 | - low lithium battery |
| 0x00000004, 4 | - AIU / analyzer data not received |
| 0x00000002, 2 | - NX19 methane=1 / gravity=0 method |
| 0x00000001, 1 | - calculation error |

A.12 XMV Interface Application

Format for the register list is array#.register#. The XMV Interface application can be enabled in any application slot.

REGISTER	DESCRIPTION	TYPE	ACCESS	NOTE
200.0	XMV 1 Modbus Address	Byte	Read/Write	1
200.1	XMV 2 Modbus Address	Byte	Read/Write	1
200.2	XMV 3 Modbus Address	Byte	Read/Write	1
200.3	XMV 4 Modbus Address	Byte	Read/Write	1
200.4	XMV 5 Modbus Address	Byte	Read/Write	1

REGISTER	DESCRIPTION	TYPE	ACCESS	NOTE
200.5	XMV 6 Modbus Address	Byte	Read/Write	1
200.6	XMV 7 Modbus Address	Byte	Read/Write	1
200.7	XMV 8 Modbus Address	Byte	Read/Write	1
200.8	XMV 9 Modbus Address	Byte	Read/Write	1
200.X	XMV (X+1) Modbus Address	Byte	Read/Write	1
201.0	XMV 1 Modbus Register	UInt16	Read/Write	2
201.1	XMV 2 Modbus Register	UInt16	Read/Write	2
201.2	XMV 3 Modbus Register	UInt16	Read/Write	2
201.3	XMV 4 Modbus Register	UInt16	Read/Write	2
201.4	XMV 5 Modbus Register	UInt16	Read/Write	2
201.5	XMV 6 Modbus Register	UInt16	Read/Write	2
201.6	XMV 7 Modbus Register	UInt16	Read/Write	2
201.7	XMV 8 Modbus Register	UInt16	Read/Write	2
201.8	XMV 9 Modbus Register	UInt16	Read/Write	2
201.X	XMV (X+1) Modbus Register	UInt16	Read/Write	2
202.0	XMV 1 Device Enable	Byte	Read/Write	3
202.1	XMV 2 Device Enable	Byte	Read/Write	3
202.2	XMV 3 Device Enable	Byte	Read/Write	3
202.3	XMV 4 Device Enable	Byte	Read/Write	3
202.4	XMV 5 Device Enable	Byte	Read/Write	3
202.5	XMV 6 Device Enable	Byte	Read/Write	3
202.6	XMV 7 Device Enable	Byte	Read/Write	3
202.7	XMV 8 Device Enable	Byte	Read/Write	3
202.8	XMV 9 Device Enable	Byte	Read/Write	3
202.X	XMV (X+1) Device Enable	Byte	Read/Write	3
203.0	XMV 1 Scan Trigger	Byte	Read Only	4
203.1	XMV 2 Scan Trigger	Byte	Read Only	4
203.2	XMV 3 Scan Trigger	Byte	Read Only	4
203.3	XMV 4 Scan Trigger	Byte	Read Only	4
203.4	XMV 5 Scan Trigger	Byte	Read Only	4
203.5	XMV 6 Scan Trigger	Byte	Read Only	4
203.6	XMV 7 Scan Trigger	Byte	Read Only	4
203.7	XMV 8 Scan Trigger	Byte	Read Only	4
203.8	XMV 9 Scan Trigger	Byte	Read Only	4
203.9	XMV 10 Scan Trigger	Byte	Read Only	4

REGISTER	DESCRIPTION	TYPE	ACCESS	NOTE
204.0	XMV 1 Raw DP Value	Float	Read/Write	5
204.1	XMV 1 Raw SP Value	Float	Read/Write	5
204.2	XMV 1 Raw TF Value	Float	Read/Write	5
204.3	XMV 2 Raw DP Value	Float	Read/Write	5
204.4	XMV 2 Raw SP Value	Float	Read/Write	5
204.5	XMV 2 Raw TF Value	Float	Read/Write	5
204.6	XMV 3 Raw DP Value	Float	Read/Write	5
204.7	XMV 3 Raw SP Value	Float	Read/Write	5
204.8	XMV 3 Raw TF Value	Float	Read/Write	5
204.X	XMV # Raw DP Value	Float	Read/Write	5
204.(X+1)	XMV # Raw SP Value	Float	Read/Write	5
204.(X+2)	XMV # Raw TF Value	Float	Read/Write	5
205.0	XMV 1 Scaled DP Value	Float	Read Only	6
205.1	XMV 1 Scaled SP Value	Float	Read Only	6
205.2	XMV 1 Scaled TF Value	Float	Read Only	6
205.3	XMV 2 Scaled DP Value	Float	Read Only	6
205.4	XMV 2 Scaled SP Value	Float	Read Only	6
205.5	XMV 2 Scaled TF Value	Float	Read Only	6
205.6	XMV 3 Scaled DP Value	Float	Read Only	6
205.7	XMV 3 Scaled SP Value	Float	Read Only	6
205.8	XMV 3 Scaled TF Value	Float	Read Only	6
205.X	XMV # Scaled DP Value	Float	Read Only	6
205.(X+1)	XMV # Scaled SP Value	Float	Read Only	6
205.(X+2)	XMV # Scaled TF Value	Float	Read Only	6
206.0	XMV 1 Communication Status	Byte	Read/Write	7
206.1	XMV 2 Communication Status	Byte	Read/Write	7
206.2	XMV 3 Communication Status	Byte	Read/Write	7
206.3	XMV 4 Communication Status	Byte	Read/Write	7
206.4	XMV 5 Communication Status	Byte	Read/Write	7
206.5	XMV 6 Communication Status	Byte	Read/Write	7
206.6	XMV 7 Communication Status	Byte	Read/Write	7
206.7	XMV 8 Communication Status	Byte	Read/Write	7
206.8	XMV 9 Communication Status	Byte	Read/Write	7
206.X	XMV (X+1) Communication Status	Byte	Read/Write	7
207.0	XMV 1 Device Type (Absolute/Gauge)	Byte	Read/Write	8

REGISTER	DESCRIPTION	TYPE	ACCESS	NOTE
207.1	XMV 2 Device Type (Absolute/Gauge)	Byte	Read/Write	8
207.2	XMV 3 Device Type (Absolute/Gauge)	Byte	Read/Write	8
207.3	XMV 4 Device Type (Absolute/Gauge)	Byte	Read/Write	8
207.4	XMV 5 Device Type (Absolute/Gauge)	Byte	Read/Write	8
207.5	XMV 6 Device Type (Absolute/Gauge)	Byte	Read/Write	8
207.6	XMV 7 Device Type (Absolute/Gauge)	Byte	Read/Write	8
207.7	XMV 8 Device Type (Absolute/Gauge)	Byte	Read/Write	8
207.8	XMV 9 Device Type (Absolute/Gauge)	Byte	Read/Write	8
207.X	XMV (X+1) Device Type (Absolute/Gauge)	Byte	Read/Write	8
208.0	XMV 1 Factory Units (Metric/English)	Byte	Read/Write	9
208.1	XMV 2 Factory Units (Metric/English)	Byte	Read/Write	9
208.2	XMV 3 Factory Units (Metric/English)	Byte	Read/Write	9
208.3	XMV 4 Factory Units (Metric/English)	Byte	Read/Write	9
208.4	XMV 5 Factory Units (Metric/English)	Byte	Read/Write	9
208.5	XMV 6 Factory Units (Metric/English)	Byte	Read/Write	9
208.6	XMV 7 Factory Units (Metric/English)	Byte	Read/Write	9
208.7	XMV 8 Factory Units (Metric/English)	Byte	Read/Write	9
208.8	XMV 9 Factory Units (Metric/English)	Byte	Read/Write	9
208.X	XMV (X+1) Factory Units (Metric/English)	Byte	Read/Write	9
209.0	XMV 1 Zero Transducer	Float	Read/Write	10
209.1	XMV 1 Calibration Point 1	Float	Read/Write	10
209.2	XMV 1 Calibration Point 2	Float	Read/Write	10
209.3	XMV 1 Calibration Point 3	Float	Read/Write	10
209.4	XMV 1 Calibration Point 4	Float	Read/Write	10
209.5	XMV 1 Calibration Point 5	Float	Read/Write	10
209.6	XMV 1 Calibration Bias	Float	Read/Write	10
209.14	XMV 1 Calibration Abort	Float	Write Only	10
209.15	XMV 1 Calibration Complete	Float	Write Only	10
209.16	XMV 2 Zero Transducer	Float	Read/Write	10
209.17	XMV 2 Calibration Point 1	Float	Read/Write	10
209.18	XMV 2 Calibration Point 2	Float	Read/Write	10
209.19	XMV 2 Calibration Point 3	Float	Read/Write	10
209.20	XMV 2 Calibration Point 4	Float	Read/Write	10
209.21	XMV 2 Calibration Point 5	Float	Read/Write	10
209.22	XMV 2 Calibration Bias	Float	Read/Write	10

REGISTER	DESCRIPTION	TYPE	ACCESS	NOTE
209.30	XMV 2 Calibration Abort	Float	Write Only	10
209.31	XMV 2 Calibration Complete	Float	Write Only	10
209.32	XMV 3 Zero Transducer	Float	Read/Write	10
209.33	XMV 3 Calibration Point 1	Float	Read/Write	10
209.34	XMV 3 Calibration Point 2	Float	Read/Write	10
209.35	XMV 3 Calibration Point 3	Float	Read/Write	10
209.36	XMV 3 Calibration Point 4	Float	Read/Write	10
209.37	XMV 3 Calibration Point 5	Float	Read/Write	10
209.38	XMV 3 Calibration Bias	Float	Read/Write	10
209.46	XMV 3 Calibration Abort	Float	Write Only	10
209.47	XMV 3 Calibration Complete	Float	Write Only	10
209.X	XMV # Zero Transducer	Float	Read/Write	10
209.X+1	XMV # Calibration Point 1	Float	Read/Write	10
209. X+2	XMV # Calibration Point 2	Float	Read/Write	10
209. X+3	XMV # Calibration Point 3	Float	Read/Write	10
209. X+4	XMV # Calibration Point 4	Float	Read/Write	10
209. X+5	XMV # Calibration Point 5	Float	Read/Write	10
209. X+6	XMV # Calibration Bias	Float	Read/Write	10
209. X+7	XMV # Calibration Abort	Float	Write Only	10
209. X+8	XMV # Calibration Complete	Float	Write Only	10
212.0	XMV 1 DP Calibration Flags	Uint16	Read Only	11
212.1	XMV 1 SP Calibration Flags	Uint16	Read Only	11
212.2	XMV 1 TF Calibration Flags	Uint16	Read Only	11
212.3	XMV 2 DP Calibration Flags	Uint16	Read Only	11
212.4	XMV 2 SP Calibration Flags	Uint16	Read Only	11
212.5	XMV 2 TF Calibration Flags	Uint16	Read Only	11
212.6	XMV 3 DP Calibration Flags	Uint16	Read Only	11
212.7	XMV 3 SP Calibration Flags	Uint16	Read Only	11
212.8	XMV 3 TF Calibration Flags	Uint16	Read Only	11
212.X	XMV # DP Calibration Flags	Uint16	Read Only	11
212.X+1	XMV # SP Calibration Flags	Uint16	Read Only	11
212.X+2	XMV # TF Calibration Flags	Uint16	Read Only	11
214.0	XMV 1 Description	String	Read/Write	
214.1	XMV 2 Description	String	Read/Write	
214.2	XMV 3 Description	String	Read/Write	

REGISTER	DESCRIPTION	TYPE	ACCESS	NOTE
214.3	XMV 4 Description	String	Read/Write	
214.4	XMV 5 Description	String	Read/Write	
214.5	XMV 6 Description	String	Read/Write	
214.6	XMV 7 Description	String	Read/Write	
214.7	XMV 8 Description	String	Read/Write	
214.X	XMV (X+1) Description	String	Read/Write	
215.0	XMV 1 Scroll Text Lock	Byte	Read/Write	
215.1	XMV 2 Scroll Text Lock	Byte	Read/Write	
215.2	XMV 3 Scroll Text Lock	Byte	Read/Write	
215.3	XMV 4 Scroll Text Lock	Byte	Read/Write	
215.4	XMV 5 Scroll Text Lock	Byte	Read/Write	
215.5	XMV 6 Scroll Text Lock	Byte	Read/Write	
215.6	XMV 7 Scroll Text Lock	Byte	Read/Write	
215.7	XMV 8 Scroll Text Lock	Byte	Read/Write	
215.8	XMV 9 Scroll Text Lock	Byte	Read/Write	
215.X	XMV (X+1) Scroll Text Lock	Byte	Read/Write	
216.0	XMV 1 Scroll Text Trigger	Byte	Read/Write	12
216.1	XMV 2 Scroll Text Trigger	Byte	Read/Write	12
216.2	XMV 3 Scroll Text Trigger	Byte	Read/Write	12
216.3	XMV 4 Scroll Text Trigger	Byte	Read/Write	12
216.4	XMV 5 Scroll Text Trigger	Byte	Read/Write	12
216.5	XMV 6 Scroll Text Trigger	Byte	Read/Write	12
216.6	XMV 7 Scroll Text Trigger	Byte	Read/Write	12
216.7	XMV 8 Scroll Text Trigger	Byte	Read/Write	12
216.8	XMV 9 Scroll Text Trigger	Byte	Read/Write	12
216.X	XMV (X+1) Scroll Text Trigger	Byte	Read/Write	12
217.0	XMV 1 DP Scroll Lock	Byte	Write Only	13
217.1	XMV 1 SP Scroll Lock	Byte	Write Only	13
217.2	XMV 1 TF Scroll Lock	Byte	Write Only	13
217.3	XMV 2 DP Scroll Lock	Byte	Write Only	13
217.4	XMV 2 SP Scroll Lock	Byte	Write Only	13
217.5	XMV 2 TF Scroll Lock	Byte	Write Only	13
217.6	XMV 3 DP Scroll Lock	Byte	Write Only	13
217.7	XMV 3 SP Scroll Lock	Byte	Write Only	13
217.8	XMV 3 TF Scroll Lock	Byte	Write Only	13

REGISTER	DESCRIPTION	TYPE	ACCESS	NOTE
217.X	XMV # DP Scroll Lock	Byte	Write Only	13
217.(X+1)	XMV # SP Scroll Lock	Byte	Write Only	13
217.(X+2)	XMV # TF Scroll Lock	Byte	Write Only	13
218.0	XMV 1 Scroll Text Register 1	Uint16	Read Only	14
218.1	XMV 1 Scroll Text Register 2	Uint16	Read Only	14
218.2	XMV 1 Scroll Text Register 3	Uint16	Read Only	14
218.3	XMV 1 Scroll Text Register 4	Uint16	Read Only	14
218.4	XMV 1 Scroll Text Register 5	Uint16	Read Only	14
218.5	XMV 1 Scroll Text Register 6	Uint16	Read Only	14
218.6	XMV 1 Scroll Text Register 7	Uint16	Read Only	14
218.7	XMV 2 Scroll Text Register 1	Uint16	Read Only	14
218.8	XMV 2 Scroll Text Register 2	Uint16	Read Only	14
218.9	XMV 2 Scroll Text Register 3	Uint16	Read Only	14
218.10	XMV 2 Scroll Text Register 4	Uint16	Read Only	14
218.11	XMV 2 Scroll Text Register 5	Uint16	Read Only	14
218.12	XMV 2 Scroll Text Register 6	Uint16	Read Only	14
218.13	XMV 2 Scroll Text Register 7	Uint16	Read Only	14
218.14	XMV 3 Scroll Text Register 1	Uint16	Read Only	14
218.15	XMV 3 Scroll Text Register 2	Uint16	Read Only	14
218.16	XMV 3 Scroll Text Register 3	Uint16	Read Only	14
218.17	XMV 3 Scroll Text Register 4	Uint16	Read Only	14
218.18	XMV 3 Scroll Text Register 5	Uint16	Read Only	14
218.19	XMV 3 Scroll Text Register 6	Uint16	Read Only	14
218.20	XMV 3 Scroll Text Register 7	Uint16	Read Only	14
218.X	XMV # Scroll Text Register 1	Uint16	Read Only	14
218.(X+1)	XMV # Scroll Text Register 2	Uint16	Read Only	14
218.(X+2)	XMV # Scroll Text Register 3	Uint16	Read Only	14
218.(X+3)	XMV # Scroll Text Register 4	Uint16	Read Only	14
218.(X+4)	XMV # Scroll Text Register 5	Uint16	Read Only	14
218.(X+5)	XMV # Scroll Text Register 6	Uint16	Read Only	14
218.(X+6)	XMV # Scroll Text Register 7	Uint16	Read Only	14
219.0-(X)	XMV # of Displays	Byte	Read/Write	
220.0-(X)	XMV 1 Display (X) Interval	Byte	Read/Write	16
221.0-(X)	XMV 1 Display (X) Top Line	String	Read/Write	17
222.0-(X)	XMV 1 Display (X) Bottom Line	String	Read/Write	17

REGISTER	DESCRIPTION	TYPE	ACCESS	NOTE
223.0-(X)	XMV 1 Display (X) Format	String	Read/Write	18
224.0-(X)	XMV 2 Display (X) Interval	Byte	Read/Write	16
225.0-(X)	XMV 2 Display (X) Top Line	String	Read/Write	17
226.0-(X)	XMV 2 Display (X) Bottom Line	String	Read/Write	17
227.0-(X)	XMV 2 Display (X) Format	String	Read/Write	18
228.0-(X)	XMV 3 Display (X) Interval	Byte	Read/Write	16
229.0-(X)	XMV 3 Display (X) Top Line	String	Read/Write	17
230.0-(X)	XMV 3 Display (X) Bottom Line	String	Read/Write	17
231.0-(X)	XMV 3 Display (X) Format	String	Read/Write	18
232.0-(X)	XMV 4 Display (X) Interval	Byte	Read/Write	16
233.0-(X)	XMV 4 Display (X) Top Line	String	Read/Write	17
234.0-(X)	XMV 4 Display (X) Bottom Line	String	Read/Write	17
235.0-(X)	XMV 4 Display (X) Format	String	Read/Write	18
236.0-(X)	XMV 5 Display (X) Interval	Byte	Read/Write	16
237.0-(X)	XMV 5 Display (X) Top Line	String	Read/Write	17
238.0-(X)	XMV 5 Display (X) Bottom Line	String	Read/Write	17
239.0-(X)	XMV 5 Display (X) Format	String	Read/Write	18
240.0-(X)	XMV 6 Display (X) Interval	Byte	Read/Write	16
241.0-(X)	XMV 6 Display (X) Top Line	String	Read/Write	17
242.0-(X)	XMV 6 Display (X) Bottom Line	String	Read/Write	17
243.0-(X)	XMV 6 Display (X) Format	String	Read/Write	18
244.0-(X)	XMV 7 Display (X) Interval	Byte	Read/Write	16
245.0-(X)	XMV 7 Display (X) Top Line	String	Read/Write	17
246.0-(X)	XMV 7 Display (X) Bottom Line	String	Read/Write	17
247.0-(X)	XMV 7 Display (X) Format	String	Read/Write	18
248.0-(X)	XMV 8 Display (X) Interval	Byte	Read/Write	16
249.0-(X)	XMV 8 Display (X) Top Line	String	Read/Write	17
250.0-(X)	XMV 8 Display (X) Bottom Line	String	Read/Write	17
251.0-(X)	XMV 8 Display (X) Format	String	Read/Write	18
255.255	Number of XMV's	Byte	Read/Write	19

A.12.1 XMV Application Register Notes

- 1) XMV Modbus Address is the address of the Modbus slave.
- 2) Each Modbus operation captures 3 register values. The XMV Modbus Register is the address of the first value to read. The read operation will capture the three consecutive register values beginning with this register.

- 3) Registers in array 202 control the scan triggers in array 203. When a register in array 202 is ENABLED (1), the corresponding register in array 203 is TRIGGERED (1). When a register in array 202 is DISABLED (0), the corresponding register in array 203 is always 0.
- 4) The MODBUS request blocks mentioned in note 5 should be configured to trigger off the corresponding register in array 203.
- 5) A MODBUS request block should be configured to read DP, SP, and TF from the XMV and store the data into the corresponding registers in array 204. The status of the scan request should be written to array 218. When the status written by the protocol is 0 (SUCCESS), the raw data is scaled and moved to array 205.
- 6) When the status written by the protocol is 0 (SUCCESS), the raw data is scaled and moved to array 205. Measurement applications should source their inputs from array 205.
- 7) The MODBUS request block for each XMV scan request should be configured to write the communication status to these status registers. When the comm status written is 0 (SUCCESS), the raw data registers (array 204) are processed (scaled) and written to the corresponding scaled data registers (array 205).
- 8) Device Static Pressure type. If the XMV is an ABB 2010, this register should be set to 0 (Absolute). If the XMV is a Rosemount 3095, this register should be set to 1 (Gauge).
- 9) If the XMV is and ABB 2010, this register should be set to 0 (Metric). If the XMV is a Rosemount 3095, this register should be set to 1 (English).
- 10) The calibration registers in array 209 should only be written by the PCCU32 calibration screen.
- 11) Calibration Bit Flags 0x0080=Factory, 0x0040=Field any thing else then in calibration sequence mode.
- 12) The MODBUS request block mentioned in note 4 above should be configured to trigger off the corresponding register in array 216.
- 13) The scroll lock registers in array 217 are written by the PCCU32 calibration screen to lock the pressure (DP or SP) being calibrated on the XMV.
- 14) The ABB 2010 series XMV allows the host to write 14 bytes of text to registers 1001-1007. The XMV interface application uses this feature to scroll user programmable displays on the XMV. A MODBUS request block must be configured to write the corresponding registers from array 218 to the XMV.
- 15) Each ABB 2010 XMV can be configured with a variable number of displays. The displays are scrolled one at a time on the device display. If number of displays are set to zero (0), three default displays (DP,SP,TF) are provided.
- 16) Each display can be configured with its own display interval. This is the minimum amount of time the display is scrolled.
- 17) The ABB 2010 display consists of 2 lines, 7 characters each. Each line can be up to 7 characters of text (such as "PSIA"), or a register (such as "11.7.0").
- 18) The display format can be specified as "Width.Decimal". To display a floating point register with three decimal places, set the format to "7.3". To display two decimal places, set the format to "7.2". To display integer registers, set the format to "7.0".
- 19) The XMV application supports a maximum of eight (25) XMVs.

A.13 Therms Master Application Registers

The Therms Master application registers allow access to the μ FLO^{G4} data items. Usage and notes are specific to the Therms Master application. Format for the register list is array#.register# description. Application number depends on the order of application instantiation. Actual array numbers for the Therms Master application are offset by 100. Low order array numbers are used for the Communication application, since the μ FLO^{G4} application is derived from a Communication application. Refer to the Communication Application Register section.

A.13.1 Therms Master Btu Byte Registers

ARRAY.REGISTER	DESCRIPTION	USAGE
100.0	Components 7001 Read trigger.	Read/Write
100.1	Reset New Data trigger.	Read/Write
100.2	3001 Poll status.	Read/Write
100.3	3058 Write status.	Read/Write
100.4	7001 Poll status.	Read/Write
100.5	Use Index 0-15 or 16-31.	Read/Write
100.6	7017 Read trigger.	Read/Write
100.7	7017 Poll status.	Read/Write
100.8	7200 Poll status.	Read/Write
100.9	3001 Read trigger.	Read/Write
100.10	7200 Read trigger.	Read/Write

A.13.2 Therms Master Btu Integer Registers

ARRAY.REGISTER	DESCRIPTION	USAGE
101.0	Components Table #1 Index #1.	Read/Write
101.1	Components Table #1 Index #2.	Read/Write
101.2	Components Table #1 Index #3.	Read/Write
101.3	Components Table #1 Index #4.	Read/Write
101.4	Components Table #1 Index #5.	Read/Write
101.5	Components Table #1 Index #6.	Read/Write
101.6	Components Table #1 Index #7.	Read/Write
101.7	Components Table #1 Index #8.	Read/Write
101.8	Components Table #1 Index #9.	Read/Write
101.9	Components Table #1 Index #10.	Read/Write
101.10	Components Table #1 Index #11.	Read/Write
101.11	Components Table #1 Index #12.	Read/Write
101.12	Components Table #1 Index #13.	Read/Write
101.13	Components Table #1 Index #14.	Read/Write
101.14	Components Table #1 Index #15.	Read/Write
101.15	Components Table #1 Index #16.	Read/Write
101.16	Components Table #2 Index #1.	Read/Write
101.17	Components Table #2 Index #2.	Read/Write
101.18	Components Table #2 Index #3.	Read/Write
101.19	Components Table #2 Index #4.	Read/Write

ARRAY.REGISTER	DESCRIPTION	USAGE
101.20	Components Table #2 Index #5.	Read/Write
101.21	Components Table #2 Index #6.	Read/Write
101.22	Components Table #2 Index #7.	Read/Write
101.23	Components Table #2 Index #8.	Read/Write
101.24	Components Table #2 Index #9.	Read/Write
101.25	Components Table #2 Index #10.	Read/Write
101.26	Components Table #2 Index #11.	Read/Write
101.27	Components Table #2 Index #12.	Read/Write
101.28	Components Table #2 Index #13.	Read/Write
101.29	Components Table #2 Index #14.	Read/Write
101.30	Components Table #2 Index #15.	Read/Write
101.31	Components Table #2 Index #16.	Read/Write
101.32	Analysis time.	Read/Write
101.33	Current Stream	Read/Write
101.34	Stream Mask.	Read/Write
101.35	Current Month.	Read/Write
101.36	Current Day.	Read/Write
101.37	Current Year.	Read/Write
101.38	Current Hour	Read/Write
101.39	Current Minutes	Read/Write
101.40	Cycle time start Month	Read/Write
101.41	Cycle time start Day	Read/Write
101.42	Cycle time start Year	Read/Write
101.43	Cycle time start Hour	Read/Write
101.44	Cycle time start Minutes	Read/Write
101.45	Bit Flags Transmitter	Read/Write
101.46	Bit Flags Transmitter	Read/Write
101.47	Bit Flags Stream 1 Low	Read/Write
101.48	Bit Flags Stream 1 High	Read/Write
101.49	Bit Flags Stream 2Low	Read/Write
101.50	Bit Flags Stream 2 High	Read/Write
101.51	Bit Flags Stream 3Low	Read/Write
101.52	Bit Flags Stream 3 High	Read/Write
101.53	Bit Flags Stream 4 Low	Read/Write
101.54	Bit Flags Stream 4 High	Read/Write

ARRAY.REGISTER	DESCRIPTION	USAGE
101.55	Bit Flags Stream 5 Low	Read/Write
101.56	Bit Flags Stream 5 High	Read/Write
101.57	New Data Flag	Read/Write
101.58	Cal/Analysis Flag	Read/Write
101.59	Cal/Analysis Flag	Read/Write

A.13.3 Therms Master Btu Float Register

ARRAY.REGISTER	DESCRIPTION	USAGE
102.0	Mole % - Component #1	Read/Write
102.1	Mole % - Component #2	Read/Write
102.2	Mole % - Component #3	Read/Write
102.3	Mole % - Component #4	Read/Write
102.4	Mole % - Component #5	Read/Write
102.5	Mole % - Component #6	Read/Write
102.6	Mole % - Component #7	Read/Write
102.7	Mole % - Component #8	Read/Write
102.8	Mole % - Component #9	Read/Write
102.9	Mole % - Component #10	Read/Write
102.10	Mole % - Component #11	Read/Write
102.11	Mole % - Component #12	Read/Write
102.12	Mole % - Component #13	Read/Write
102.13	Mole % - Component #14	Read/Write
102.14	Mole % - Component #15	Read/Write
102.15	Mole % - Component #4	Read/Write
102.16	GPM - Component #1	Read/Write
102.17	GPM - Component #2	Read/Write
102.18	GPM - Component #3	Read/Write
102.19	GPM - Component #4	Read/Write
102.20	GPM - Component #5	Read/Write
102.21	GPM - Component #6	Read/Write
102.22	GPM - Component #7	Read/Write
102.23	GPM - Component #8	Read/Write
102.24	GPM - Component #9	Read/Write
102.25	GPM - Component #10	Read/Write
102.26	GPM - Component #11	Read/Write

ARRAY.REGISTER	DESCRIPTION	USAGE
102.27	GPM - Component #12	Read/Write
102.28	GPM - Component #13	Read/Write
102.29	GPM - Component #14	Read/Write
102.30	GPM - Component #15	Read/Write
102.31	GPM - Component #16	Read/Write
102.32	Btu Dry.	Read/Write
102.33	Btu Saturated	Read/Write
102.34	Specific Gravity	Read/Write
102.35	Compressibility	Read/Write
102.36	Wobbe Index	Read/Write
102.37	Total Un-normalized mole	Read/Write
102.38	Total GPM	Read/Write
102.39	Ratio#1 - Unused	Read/Write

A.13.4 Therms Master Stream 1 Float Registers

ARRAY.REGISTER	DESCRIPTION	USAGE
103.0	N2 – Btu Stream Component.	Read/Write
103.1	CO2 – Btu Stream Component.	Read/Write
103.2	H2S – Btu Stream Component.	Read/Write
103.3	H2O – Btu Stream Component.	Read/Write
103.4	HE – Btu Stream Component.	Read/Write
103.5	C1 – Btu Stream Component.	Read/Write
103.6	C2 – Btu Stream Component.	Read/Write
103.7	C3 – Btu Stream Component.	Read/Write
103.8	NC4 – Btu Stream Component.	Read/Write
103.9	IC4 – Btu Stream Component.	Read/Write
103.10	NC5 – Btu Stream Component.	Read/Write
103.11	IC5 – Btu Stream Component.	Read/Write
103.12	NC6 – Btu Stream Component.	Read/Write
103.13	NC7 – Btu Stream Component.	Read/Write
103.14	NC8 – Btu Stream Component.	Read/Write
103.15	NC9 – Btu Stream Component.	Read/Write
103.16	NC10 – Btu Stream Component.	Read/Write
103.17	O2 – Btu Stream Component.	Read/Write
103.18	CO – Btu Stream Component.	Read/Write

ARRAY.REGISTER	DESCRIPTION	USAGE
103.19	H2 – Btu Stream Component.	Read/Write
103.20	AR – Btu Stream Component.	Read/Write
103.21	AIR – Btu Stream Component.	Read/Write
103.22	C6PLUS – Btu Stream Component.	Read/Write
103.23	BTU – Btu Stream Component.	Read/Write
103.24	GF – Btu Stream Component.	Read/Write
103.25	SGF – Btu Stream Component.	Read/Write
103.26	CPCV – Btu Stream Component.	Read/Write
103.27	VISCOSITY – Btu Stream Component.	Read/Write
103.28	DENSITY – Btu Stream Component.	Read/Write
103.29	FT – Btu Stream Component.	Read/Write
103.30	FP – Btu Stream Component.	Read/Write
103.31	C7PLUS – Btu Stream Component.	Read/Write
103.32	C8PLUS – Btu Stream Component.	Read/Write
103.33	H2OCONTENT – Btu Stream Component.	Read/Write
103.34	H2OBIAS – Btu Stream Component.	Read/Write
103.35	EOXMAP – Btu Stream Component.	Read/Write
103.36	NEOC5 – Btu Stream Component.	Read/Write
103.37	C3PRIME – Btu Stream Component.	Read/Write
103.38	C4PLUS – Btu Stream Component.	Read/Write
103.39	SATBTU – Btu Stream Component.	Read/Write
103.40	Z – Btu Stream Component.	Read/Write
103.41	WOBBE – Btu Stream Component.	Read/Write
103.42	STREAM NUMBER.	Read/Write
103.43	STREAM TIME.	Read/Write

A.13.5 Therms Master Stream 2 float Registers

ARRAY.REGISTER	DESCRIPTION	USAGE
104.0	N2 – Btu Stream Component.	Read/Write
104.1	CO2 – Btu Stream Component.	Read/Write
104.2	H2S – Btu Stream Component.	Read/Write
104.3	H2O – Btu Stream Component.	Read/Write
104.4	HE – Btu Stream Component.	Read/Write
104.5	C1 – Btu Stream Component.	Read/Write
104.6	C2 – Btu Stream Component.	Read/Write

ARRAY.REGISTER	DESCRIPTION	USAGE
104.7	C3 – Btu Stream Component.	Read/Write
104.8	NC4 – Btu Stream Component.	Read/Write
104.9	IC4 – Btu Stream Component.	Read/Write
104.10	NC5 – Btu Stream Component.	Read/Write
104.11	IC5 – Btu Stream Component.	Read/Write
104.12	NC6 – Btu Stream Component.	Read/Write
104.13	NC7 – Btu Stream Component.	Read/Write
104.14	NC8 – Btu Stream Component.	Read/Write
104.15	NC9 – Btu Stream Component.	Read/Write
104.16	NC10 – Btu Stream Component.	Read/Write
104.17	O2 – Btu Stream Component.	Read/Write
104.18	CO – Btu Stream Component.	Read/Write
104.19	H2 – Btu Stream Component.	Read/Write
104.20	AR – Btu Stream Component.	Read/Write
104.21	AIR – Btu Stream Component.	Read/Write
104.22	C6PLUS – Btu Stream Component.	Read/Write
104.23	BTU – Btu Stream Component.	Read/Write
104.24	GF – Btu Stream Component.	Read/Write
104.25	SGF – Btu Stream Component.	Read/Write
104.26	CPCV – Btu Stream Component.	Read/Write
104.27	VISCOSITY – Btu Stream Component.	Read/Write
104.28	DENSITY – Btu Stream Component.	Read/Write
104.29	FT – Btu Stream Component.	Read/Write
104.30	FP – Btu Stream Component.	Read/Write
104.31	C7PLUS – Btu Stream Component.	Read/Write
104.32	C8PLUS – Btu Stream Component.	Read/Write
104.33	H2OCONTENT – Btu Stream Component.	Read/Write
104.34	H2OBIAS – Btu Stream Component.	Read/Write
104.35	EOAXMAP – Btu Stream Component.	Read/Write
104.36	NEOC5 – Btu Stream Component.	Read/Write
104.37	C3PRIME – Btu Stream Component.	Read/Write
104.38	C4PLUS – Btu Stream Component.	Read/Write
104.39	SATBTU – Btu Stream Component.	Read/Write
104.40	Z – Btu Stream Component.	Read/Write
104.41	WOBBE – Btu Stream Component.	Read/Write

ARRAY.REGISTER	DESCRIPTION	USAGE
104.42	STREAM NUMBER.	Read/Write
104.43	STREAM TIME.	Read/Write

A.13.6 Therms Master Stream 3 Float Registers

ARRAY.REGISTER	DESCRIPTION	USAGE
105.0	N2 – Btu Stream Component.	Read/Write
105.1	CO2 – Btu Stream Component.	Read/Write
105.2	H2S – Btu Stream Component.	Read/Write
105.3	H2O – Btu Stream Component.	Read/Write
105.4	HE – Btu Stream Component.	Read/Write
105.5	C1 – Btu Stream Component.	Read/Write
105.6	C2 – Btu Stream Component.	Read/Write
105.7	C3 – Btu Stream Component.	Read/Write
105.8	NC4 – Btu Stream Component.	Read/Write
105.9	IC4 – Btu Stream Component.	Read/Write
105.10	NC5 – Btu Stream Component.	Read/Write
105.11	IC5 – Btu Stream Component.	Read/Write
105.12	NC6 – Btu Stream Component.	Read/Write
105.13	NC7 – Btu Stream Component.	Read/Write
105.14	NC8 – Btu Stream Component.	Read/Write
105.15	NC9 – Btu Stream Component.	Read/Write
105.16	NC10 – Btu Stream Component.	Read/Write
105.17	O2 – Btu Stream Component.	Read/Write
105.18	CO – Btu Stream Component.	Read/Write
105.19	H2 – Btu Stream Component.	Read/Write
105.20	AR – Btu Stream Component.	Read/Write
105.21	AIR – Btu Stream Component.	Read/Write
105.22	C6PLUS – Btu Stream Component.	Read/Write
105.23	BTU – Btu Stream Component.	Read/Write
105.24	GF – Btu Stream Component.	Read/Write
105.25	SGF – Btu Stream Component.	Read/Write
105.26	CPCV – Btu Stream Component.	Read/Write
105.27	VISCOSITY – Btu Stream Component.	Read/Write
105.28	DENSITY – Btu Stream Component.	Read/Write
105.29	FT – Btu Stream Component.	Read/Write

ARRAY.REGISTER	DESCRIPTION	USAGE
105.30	FP – Btu Stream Component.	Read/Write
105.31	C7PLUS – Btu Stream Component.	Read/Write
105.32	C8PLUS – Btu Stream Component.	Read/Write
105.33	H2OCONTENT – Btu Stream Component.	Read/Write
105.34	H2OBIAS – Btu Stream Component.	Read/Write
105.35	EOXMAP – Btu Stream Component.	Read/Write
105.36	NEOC5 – Btu Stream Component.	Read/Write
105.37	C3PRIME – Btu Stream Component.	Read/Write
105.38	C4PLUS – Btu Stream Component.	Read/Write
105.39	SATBTU – Btu Stream Component.	Read/Write
105.40	Z – Btu Stream Component.	Read/Write
105.41	WOBBE – Btu Stream Component.	Read/Write
105.42	STREAM NUMBER.	Read/Write
105.43	STREAM TIME.	Read/Write

A.13.7 Therms Master Stream 4 Float Registers

ARRAY.REGISTER	DESCRIPTION	USAGE
106.0	N2 – Btu Stream Component.	Read/Write
106.1	CO2 – Btu Stream Component.	Read/Write
106.2	H2S – Btu Stream Component.	Read/Write
106.3	H2O – Btu Stream Component.	Read/Write
106.4	HE – Btu Stream Component.	Read/Write
106.5	C1 – Btu Stream Component.	Read/Write
106.6	C2 – Btu Stream Component.	Read/Write
106.7	C3 – Btu Stream Component.	Read/Write
106.8	NC4 – Btu Stream Component.	Read/Write
106.9	IC4 – Btu Stream Component.	Read/Write
106.10	NC5 – Btu Stream Component.	Read/Write
106.11	IC5 – Btu Stream Component.	Read/Write
106.12	NC6 – Btu Stream Component.	Read/Write
106.13	NC7 – Btu Stream Component.	Read/Write
106.14	NC8 – Btu Stream Component.	Read/Write
106.15	NC9 – Btu Stream Component.	Read/Write
106.16	NC10 – Btu Stream Component.	Read/Write
106.17	O2 – Btu Stream Component.	Read/Write

ARRAY.REGISTER	DESCRIPTION	USAGE
106.18	CO – Btu Stream Component.	Read/Write
106.19	H2 – Btu Stream Component.	Read/Write
106.20	AR – Btu Stream Component.	Read/Write
106.21	AIR – Btu Stream Component.	Read/Write
106.22	C6PLUS – Btu Stream Component.	Read/Write
106.23	BTU – Btu Stream Component.	Read/Write
106.24	GF – Btu Stream Component.	Read/Write
106.25	SGF – Btu Stream Component.	Read/Write
106.26	CPCV – Btu Stream Component.	Read/Write
106.27	VISCOSITY – Btu Stream Component.	Read/Write
106.28	DENSITY – Btu Stream Component.	Read/Write
106.29	FT – Btu Stream Component.	Read/Write
106.30	FP – Btu Stream Component.	Read/Write
106.31	C7PLUS – Btu Stream Component.	Read/Write
106.32	C8PLUS – Btu Stream Component.	Read/Write
106.33	H2OCONTENT – Btu Stream Component.	Read/Write
106.34	H2OBIAS – Btu Stream Component.	Read/Write
106.35	EOAXMAP – Btu Stream Component.	Read/Write
106.36	NEOC5 – Btu Stream Component.	Read/Write
106.37	C3PRIME – Btu Stream Component.	Read/Write
106.38	C4PLUS – Btu Stream Component.	Read/Write
106.39	SATBTU – Btu Stream Component.	Read/Write
106.40	Z – Btu Stream Component.	Read/Write
106.41	WOBBE – Btu Stream Component.	Read/Write
106.42	STREAM NUMBER.	Read/Write
106.43	STREAM TIME.	Read/Write

A.13.8 Therms Master Btu Var Integer Registers

ARRAY.REGISTER	DESCRIPTION	USAGE
107.0	Master Stream ID.	Read/Write- see note 1

A.13.8.1 Therms Master Notes

- 1) Stream Id Bits:
 - Bit 0 : No/Yes(0/1) – Send stream 1 to this slave
 - Bit 1 : No/Yes(0/1) – Send stream 2 to this slave
 - Bit 2 : No/Yes(0/1) – Send stream 3 to this slave
 - Bit 3 : No/Yes(0/1) – Send stream 4 to this slave

A.13.9 Therms Master Btu Var Int32 Registers

ARRAY.REGISTER	DESCRIPTION	USAGE
108.0	N/A	
108.1	Current Stream 1 Time.	Read/Write
108.2	Current Stream 2 Time.	Read/Write
108.3	Current Stream 3 Time.	Read/Write
108.4	Current Stream 4 Time.	Read/Write
108.5	Elapsed Stream 1 Time.	Read/Write
108.6	Elapsed Stream 2 Time.	Read/Write
108.7	Elapsed Stream 3 Time.	Read/Write
108.8	Elapsed Stream 4 Time.	Read/Write

A.13.10 Therms Master Slave Data Trigger Registers

ARRAY.REGISTER	DESCRIPTION	USAGE
109.0	Slave Data Send Trigger.	Read/Write

Note: For succeeding slaves, the register offset for each slave = (slavenum*1) + Index. Example: The index register for the slave data trigger for slave 2 = (1*1) + 0.

A.13.11 Therms Master Current Stream Float Registers

ARRAY.REGISTER	DESCRIPTION	USAGE
110.0	N2 – Btu Stream Component.	Read/Write
110.1	CO2 – Btu Stream Component.	Read/Write
110.2	H2S – Btu Stream Component.	Read/Write
110.3	H2O – Btu Stream Component.	Read/Write
110.4	HE – Btu Stream Component.	Read/Write
110.5	C1 – Btu Stream Component.	Read/Write
110.6	C2 – Btu Stream Component.	Read/Write
110.7	C3 – Btu Stream Component.	Read/Write
110.8	NC4 – Btu Stream Component.	Read/Write
110.9	IC4 – Btu Stream Component.	Read/Write
110.10	NC5 – Btu Stream Component.	Read/Write
110.11	IC5 – Btu Stream Component.	Read/Write
110.12	NC6 – Btu Stream Component.	Read/Write
110.13	NC7 – Btu Stream Component.	Read/Write
110.14	NC8 – Btu Stream Component.	Read/Write
110.15	NC9 – Btu Stream Component.	Read/Write
110.16	NC10 – Btu Stream Component.	Read/Write

ARRAY.REGISTER	DESCRIPTION	USAGE
110.17	O2 – Btu Stream Component.	Read/Write
110.18	CO – Btu Stream Component.	Read/Write
110.19	H2 – Btu Stream Component.	Read/Write
110.20	AR – Btu Stream Component.	Read/Write
110.21	AIR – Btu Stream Component.	Read/Write
110.22	C6PLUS – Btu Stream Component.	Read/Write
110.23	BTU – Btu Stream Component.	Read/Write
110.24	GF – Btu Stream Component.	Read/Write
110.25	SGF – Btu Stream Component.	Read/Write
110.26	CPCV – Btu Stream Component.	Read/Write
110.27	VISCOSITY – Btu Stream Component.	Read/Write
110.28	DENSITY – Btu Stream Component.	Read/Write
110.29	FT – Btu Stream Component.	Read/Write
110.30	FP – Btu Stream Component.	Read/Write
110.31	C7PLUS – Btu Stream Component.	Read/Write
110.32	C8PLUS – Btu Stream Component.	Read/Write
110.33	H2OCONTENT – Btu Stream Component.	Read/Write
110.34	H2OBIAS – Btu Stream Component.	Read/Write
110.35	EOXMAP – Btu Stream Component.	Read/Write
110.36	NEOC5 – Btu Stream Component.	Read/Write
110.37	C3PRIME – Btu Stream Component.	Read/Write
110.38	C4PLUS – Btu Stream Component.	Read/Write
110.39	SATBTU – Btu Stream Component.	Read/Write
110.40	Z – Btu Stream Component.	Read/Write
110.41	WOBBE – Btu Stream Component.	Read/Write
110.42	STREAM NUMBER.	Read/Write
110.43	STREAM TIME.	Read/Write

A.13.12 Therms Master Slave Var Integer Registers

ARRAY.REGISTER	DESCRIPTION	USAGE
111.0	Slave Steam Id.	Read/Write

Note: For succeeding slaves, the register offset for each slave = (slavenum * 1) + Index.

Example: Index register for slave stream ID for slave 2 = (1 * 1) + 0

Stream Id Bits:

Bit 0 : No/Yes(0/1) – Send stream 1 to this slave

Bit 1 : No/Yes(0/1) – Send stream 2 to this slave

Bit 2 : No/Yes(0/1) – Send stream 3 to this slave

Bit 3 : No/Yes(0/1) – Send stream 4 to this slave

A.13.13 Therms Master Stream Time String Register

ARRAY.REGISTER	DESCRIPTION	USAGE
112.0	Current Stream 1 Time, String formatted.	Read
112.1	Current Stream 2Time, String formatted.	Read
112.2	Current Stream 3 Time, String formatted.	Read
112.3	Current Stream 4 Time, String formatted.	Read

A.13.14 Therms Master Slave Var Integer Registers

ARRAY.REGISTER	DESCRIPTION	USAGE
113.0	Slave Data Send Status.	Read/Write

Note: For succeeding slaves, the register offset for each slave = (slavenum*1) + Index. Index register for slave data send status for slave 2 = (1*1) + 0.

A.14 Therms Display Registers

ARRAY.REGISTER	DESCRIPTION	USAGE
114.0	Analyzer Alarm, string based on value in App.115.17, 0 = "Normal", Not 0 = "Fault"	Read
114.1	Stream 1 Alarm, string based on value in App.115.24, 0 = "Normal", Not 0 = "Fault"	Read
114.2	Stream 2 Alarm, string based on value in App.115.25, 0 = "Normal", Not 0 = "Fault"	Read
114.3	Stream 3 Alarm, string based on value in app.115.26, 0 = "Normal", Not 0 = "Fault"	Read
114.4	Stream 4 Alarm, string based on value in App.115.27, 0 = "Normal", Not 0 = "Fault"	Read
114.5	Analyzer Mode, string based on value in App.101.59, 1 = "Hold", 2 = "Run", 3 = "SingleCycle", 4 = "Abort", 5 = "Calibrate", 6 = "StartUp".	Read
114.6	Helium Psi, string based on value in App.115.11, 0 = "Normal", Not 0 = "Low"	Read
114.7	Cal Psi, string based on value in App.115.12, 0 = "Normal", Not 0 = "Low"	Read

A.14.1 Therms Status Btu Integer Registers

ARRAY.REGISTER	DESCRIPTION	USAGE
115.0	Set Next State(3061)	Read/Write
115.1	Auto Calibration during startup	Read/Write

ARRAY.REGISTER	DESCRIPTION	USAGE
115.2	Auto Peak Detection during startup	Read/Write
115.3	Auto Run after startup	Read/Write
115.4	Number of Calibration cycles	Read/Write
115.5	Number of Calibration cycles to Average	Read/Write
115.6	Low Carrier Mode.	Read/Write
115.7	Low Power Mode.	Read/Write
115.8	Pre-Purge Selection.	Read/Write
115.9	Normal Status.	Read/Write
115.10	Fault Status.	Read/Write
115.11	Carrier Bottle Low.(3072	Read/Write
115.12	Calibration Bottle Low.(3073)	Read/Write
115.13	Manually Update Response Factors	Read/Write
115.14	Auto Update Response Factors Selection	Read/Write
115.15	Disable Stream Switching.	Read/Write
115.16	Transmitter Current Warning	Read/Write
115.17	Transmitter Current Fault.(3078)	Read/Write
115.18	Transmitter Initial Warning.	Read/Write
115.19	Transmitter Initial Fault	Read/Write
115.20	Stream 1 Current Warning	Read/Write
115.21	Stream 1 Current Warning	Read/Write
115.22	Stream 1 Current Warning	Read/Write
115.23	Stream 1 Current Warning	Read/Write
115.24	Stream 1 Current Fault(3085)	Read/Write
115.25	Stream 2 Current Fault(3086)	Read/Write
115.26	Stream 3 Current Fault.(3087)	Read/Write
115.27	Stream 4 Current Fault(3088).	Read/Write

A.14.2 Therms Status Float Registers

ARRAY.REGISTER	DESCRIPTION	USAGE
116.0	Ground Ref. (7200)	Read/Write
116.1	Power- Battery Voltage (7201)	Read/Write
116.2	Mandrel Temp (7202)	Read/Write
116.3	Carrier Press. (7203)	Read/Write
116.4	Aux. Press. (7204)	Read/Write
116.5	AI-6 Spare (7205)	Read/Write

ARRAY.REGISTER	DESCRIPTION	USAGE
116.6	Ambient Temp(7206)	Read/Write
116.7	Voltage Ref. (7207)	Read/Write

A.14.3 Therms Stream SN Int32 Registers

ARRAY.REGISTER	DESCRIPTION	USAGE
117.0	New Data Stream 1	Read/Write
117.1	New Data Stream 2	Read/Write
117.2	New Data Stream 3	Read/Write
117.3	New Data Stream 4	Read/Write

A.14.4 Therms Master Component Xref Index Registers

ARRAY.REGISTER	DESCRIPTION	USAGE
118.0	Components Index Xref Index #1.	Read/Write
118.1	Components Index Xref Index #2.	Read/Write
118.2	Components Index Xref Index #3.	Read/Write
118.3	Components Index Xref Index #4.	Read/Write
118.4	Components Index Xref Index #5.	Read/Write
118.5	Components Index Xref Index #6.	Read/Write
118.6	Components Index Xref Index #7.	Read/Write
118.7	Components Index Xref Index #8.	Read/Write
118.8	Components Index Xref Index #9.	Read/Write
118.9	Components Index Xref Index #10	Read/Write
118.10	Components Index Xref Index #11	Read/Write
118.11	Components Index Xref Index #12	Read/Write
118.12	Components Index Xref Index #13	Read/Write
118.13	Components Index Xref Index #14	Read/Write
118.14	Components Index Xref Index #15	Read/Write
118.15	Components Index Xref Index #16	Read/Write
118.16	Components Index Xref Index #17	Read/Write
118.17	Components Index Xref Index #18	Read/Write
118.18	Components Index Xref Index #19	Read/Write
118.19	Components Index Xref Index #20.	Read/Write
118.20	Components Index Xref Index #21.	Read/Write
118.21	Components Index Xref Index #22.	Read/Write
118.22	Components Index Xref Index #23.	Read/Write

ARRAY.REGISTER	DESCRIPTION	USAGE
118.23	Components Index Xref Index #24.	Read/Write
118.24	Components Index Xref Index #25.	Read/Write
118.25	Components Index Xref Index #26.	Read/Write
118.26	Components Index Xref Index #27.	Read/Write
118.27	Components Index Xref Index #28.	Read/Write
118.28	Components Index Xref Index #29.	Read/Write
118.29	Components Index Xref Index #30.	Read/Write
118.30	Components Index Xref Index #31.	Read/Write
118.31	Components Index Xref Index #32.	Read/Write

A.14.5 Therms Master Btu Byte Registers

ARRAY.REGISTER	DESCRIPTION	USAGE
119.0	Stream 1 Source App.	Read/Write
119.1	Stream 2 Source App.	Read/Write
119.2	Stream 3 Source App.	Read/Write
119.3	Stream 4 Source App.	Read/Write
119.4	Use Data From Source (Therms or NGC).	Read/Write
119.5	Stream 1 NGC Trigger.	Read/Write
119.6	Stream 2 NGC Trigger.	Read/Write
119.7	Stream 3 NGC Trigger.	Read/Write
119.8	Stream 4 NGC Trigger.	Read/Write
119.9	Therms Master MB Address.	Read/Write
119.10	Scan Enable 3001.	Read/Write
119.11	Scan Enable 7200.	Read/Write
119.12	Scan Enable 7001.	Read/Write
119.13	Scan Enable 7017.	Read/Write
119.14	Scan Enable 3058.	Read/Write
119.15	Use ABB Scan or 2251 Scans.	Read/Write
119.16	Use New Data Flag or Cycle Time	Read/Write

A.14.6 Therms Master Component Xrefed Index Registers

ARRAY.REGISTER	DESCRIPTION	USAGE
120.0	Components Index Xrefed Index #1.	Read/Write
120.1	Components Index Xrefed Index #2.	Read/Write
120.2	Components Index Xrefed Index #3.	Read/Write
120.3	Components Index Xrefed Index #4.	Read/Write

ARRAY.REGISTER	DESCRIPTION	USAGE
120.4	Components Index Xrefed Index #5.	Read/Write
120.5	Components Index Xrefed Index #6.	Read/Write
120.6	Components Index Xrefed Index #7.	Read/Write
120.7	Components Index Xrefed Index #8.	Read/Write
120.8	Components Index Xrefed Index #9.	Read/Write
120.9	Components Index Xrefed Index #10	Read/Write
120.10	Components Index Xrefed Index #11	Read/Write
120.11	Components Index Xrefed Index #12	Read/Write
120.12	Components Index Xrefed Index #13	Read/Write
120.13	Components Index Xrefed Index #14	Read/Write
120.14	Components Index Xrefed Index #15	Read/Write
120.15	Components Index Xrefed Index #16	Read/Write
120.16	Components Index Xrefed Index #17	Read/Write
120.17	Components Index Xrefed Index #18	Read/Write
120.18	Components Index Xrefed Index #19	Read/Write
120.19	Components Index Xrefed Index #20.	Read/Write
120.20	Components Index Xrefed Index #21.	Read/Write
120.21	Components Index Xrefed Index #22.	Read/Write
120.22	Components Index Xrefed Index #23.	Read/Write
120.23	Components Index Xrefed Index #24.	Read/Write
120.24	Components Index Xrefed Index #25.	Read/Write
120.25	Components Index Xrefed Index #26.	Read/Write
120.26	Components Index Xrefed Index #27.	Read/Write
120.27	Components Index Xrefed Index #28.	Read/Write
120.28	Components Index Xrefed Index #29.	Read/Write
120.29	Components Index Xrefed Index #30.	Read/Write
120.30	Components Index Xrefed Index #31.	Read/Write
120.31	Components Index Xrefed Index #32.	Read/Write

A.14.7 Therms Slave Var Modbus Address Registers

ARRAY.REGISTER	DESCRIPTION	USAGE
121.0	Slave Modbus Address.	Read/Write

Note: For succeeding slaves, the register offset for each slave = (slavenum*1) + Index. Index register for slave data trigger for slave 2 = (1*1) + 0.

A.14.8 Therms Slave Var Modbus Address Registers

ARRAY.REGISTER	DESCRIPTION	USAGE
122.0	Slave Scan Enable.	Read/Write

Note: For succeeding slaves, the register offset for each slave = (slavenum*1) + Index. Index register for slave data trigger for slave 2 = (1*1) + 0.

A.14.9 Therms Interface Control Get Request Registers

ARRAY.REGISTER	DESCRIPTION	USAGE
123.0	Therms Master Interface Control Get Request Register	Read/Write

A.14.10 Therms Master Int32 Registers

ARRAY.REGISTER	DESCRIPTION	USAGE
124.0	Scan Time for 3001	Read/Write
124.1	Scan Time for 7200	Read/Write

A.14.11 Therms Slave Stream 1 Float Registers

ARRAY.REGISTER	DESCRIPTION	USAGE
251.0	N2 – Btu Stream Component.	Read/Write
251.1	CO2 – Btu Stream Component.	Read/Write
251.2	H2S – Btu Stream Component.	Read/Write
251.3	H2O – Btu Stream Component.	Read/Write
251.4	HE – Btu Stream Component.	Read/Write
251.5	C1 – Btu Stream Component.	Read/Write
251.6	C2 – Btu Stream Component.	Read/Write
251.7	C3 – Btu Stream Component.	Read/Write
251.8	NC4 – Btu Stream Component.	Read/Write
251.9	IC4 – Btu Stream Component.	Read/Write
251.10	NC5 – Btu Stream Component.	Read/Write
251.11	IC5 – Btu Stream Component.	Read/Write
251.12	NC6 – Btu Stream Component.	Read/Write
251.13	NC7 – Btu Stream Component.	Read/Write
251.14	NC8 – Btu Stream Component.	Read/Write
251.15	NC9 – Btu Stream Component.	Read/Write
251.16	NC10 – Btu Stream Component.	Read/Write
251.17	O2 – Btu Stream Component.	Read/Write
251.18	CO – Btu Stream Component.	Read/Write
251.19	H2 – Btu Stream Component.	Read/Write
251.20	AR – Btu Stream Component.	Read/Write

ARRAY.REGISTER	DESCRIPTION	USAGE
251.21	AIR – Btu Stream Component.	Read/Write
251.22	C6PLUS – Btu Stream Component.	Read/Write
251.23	BTU – Btu Stream Component.	Read/Write
251.24	GF – Btu Stream Component.	Read/Write
251.25	NEOC5 – Btu Stream Component.	Read/Write

A.14.12 Therms Slave Stream 2 Float Registers

ARRAY.REGISTER	DESCRIPTION	USAGE
252.0	N2 – Btu Stream Component.	Read/Write
252.1	CO2 – Btu Stream Component.	Read/Write
252.2	H2S – Btu Stream Component.	Read/Write
252.3	H2O – Btu Stream Component.	Read/Write
252.4	HE – Btu Stream Component.	Read/Write
252.5	C1 – Btu Stream Component.	Read/Write
252.6	C2 – Btu Stream Component.	Read/Write
252.7	C3 – Btu Stream Component.	Read/Write
252.8	NC4 – Btu Stream Component.	Read/Write
252.9	IC4 – Btu Stream Component.	Read/Write
252.10	NC5 – Btu Stream Component.	Read/Write
252.11	IC5 – Btu Stream Component.	Read/Write
252.12	NC6 – Btu Stream Component.	Read/Write
252.13	NC7 – Btu Stream Component.	Read/Write
252.14	NC8 – Btu Stream Component.	Read/Write
252.15	NC9 – Btu Stream Component.	Read/Write
252.16	NC10 – Btu Stream Component.	Read/Write
252.17	O2 – Btu Stream Component.	Read/Write
252.18	CO – Btu Stream Component.	Read/Write
252.19	H2 – Btu Stream Component.	Read/Write
252.20	AR – Btu Stream Component.	Read/Write
252.21	AIR – Btu Stream Component.	Read/Write
252.22	C6PLUS – Btu Stream Component.	Read/Write
252.23	BTU – Btu Stream Component.	Read/Write
252.24	GF – Btu Stream Component.	Read/Write
252.25	NEOC5 – Btu Stream Component.	Read/Write

A.14.13 Therms Slave Stream 3 Float Registers

ARRAY.REGISTER	DESCRIPTION	USAGE
253.0	N2 – Btu Stream Component.	Read/Write
253.1	CO2 – Btu Stream Component.	Read/Write
253.2	H2S – Btu Stream Component.	Read/Write
253.3	H2O – Btu Stream Component.	Read/Write
253.4	HE – Btu Stream Component.	Read/Write
253.5	C1 – Btu Stream Component.	Read/Write
253.6	C2 – Btu Stream Component.	Read/Write
253.7	C3 – Btu Stream Component.	Read/Write
253.8	NC4 – Btu Stream Component.	Read/Write
253.9	IC4 – Btu Stream Component.	Read/Write
253.10	NC5 – Btu Stream Component.	Read/Write
253.11	IC5 – Btu Stream Component.	Read/Write
253.12	NC6 – Btu Stream Component.	Read/Write
253.13	NC7 – Btu Stream Component.	Read/Write
253.14	NC8 – Btu Stream Component.	Read/Write
253.15	NC9 – Btu Stream Component.	Read/Write
253.16	NC10 – Btu Stream Component.	Read/Write
253.17	O2 – Btu Stream Component.	Read/Write
253.18	CO – Btu Stream Component.	Read/Write
253.19	H2 – Btu Stream Component.	Read/Write
253.20	AR – Btu Stream Component.	Read/Write
253.21	AIR – Btu Stream Component.	Read/Write
253.22	C6PLUS – Btu Stream Component.	Read/Write
253.23	BTU – Btu Stream Component.	Read/Write
253.24	GF – Btu Stream Component.	Read/Write
253.25	NEOC5 – Btu Stream Component.	Read/Write

A.14.14 Therms Master Slave Stream 4 Float Registers

ARRAY.REGISTER	DESCRIPTION	USAGE
254.0	N2 – Btu Stream Component.	Read/Write
254.1	CO2 – Btu Stream Component.	Read/Write
254.2	H2S – Btu Stream Component.	Read/Write
254.3	H2O – Btu Stream Component.	Read/Write
254.4	HE – Btu Stream Component.	Read/Write

ARRAY.REGISTER	DESCRIPTION	USAGE
254.5	C1 – Btu Stream Component.	Read/Write
254.6	C2 – Btu Stream Component.	Read/Write
254.7	C3 – Btu Stream Component.	Read/Write
254.8	NC4 – Btu Stream Component.	Read/Write
254.9	IC4 – Btu Stream Component.	Read/Write
254.10	NC5 – Btu Stream Component.	Read/Write
254.11	IC5 – Btu Stream Component.	Read/Write
254.12	NC6 – Btu Stream Component.	Read/Write
254.13	NC7 – Btu Stream Component.	Read/Write
254.14	NC8 – Btu Stream Component.	Read/Write
254.15	NC9 – Btu Stream Component.	Read/Write
254.16	NC10 – Btu Stream Component.	Read/Write
254.17	O2 – Btu Stream Component.	Read/Write
254.18	CO – Btu Stream Component.	Read/Write
254.19	H2 – Btu Stream Component.	Read/Write
254.20	AR – Btu Stream Component.	Read/Write
254.21	AIR – Btu Stream Component.	Read/Write
254.22	C6PLUS – Btu Stream Component.	Read/Write
254.23	BTU – Btu Stream Component.	Read/Write
254.24	GF – Btu Stream Component.	Read/Write
254.25	NEOC5 – Btu Stream Component.	Read/Write

A.14.15 Therms Master Slave Analysis Trend File

ARRAY.REGISTER	DESCRIPTION	USAGE
255.0	N2 – Btu Stream Component.	Read/Write
255.1	CO2 – Btu Stream Component.	Read/Write
255.2	H2S – Btu Stream Component.	Read/Write
255.3	H2O – Btu Stream Component.	Read/Write
255.4	HE – Btu Stream Component.	Read/Write
255.5	C1 – Btu Stream Component.	Read/Write
255.6	C2 – Btu Stream Component.	Read/Write
255.7	C3 – Btu Stream Component.	Read/Write
255.8	NC4 – Btu Stream Component.	Read/Write
255.9	IC4 – Btu Stream Component.	Read/Write
255.10	NC5 – Btu Stream Component.	Read/Write

ARRAY.REGISTER	DESCRIPTION	USAGE
255.11	IC5 – Btu Stream Component.	Read/Write
255.12	NC6 – Btu Stream Component.	Read/Write
255.13	NC7 – Btu Stream Component.	Read/Write
255.14	NC8 – Btu Stream Component.	Read/Write
255.15	NC9 – Btu Stream Component.	Read/Write
255.16	NC10 – Btu Stream Component.	Read/Write
255.17	O2 – Btu Stream Component.	Read/Write
255.18	CO – Btu Stream Component.	Read/Write
255.19	H2 – Btu Stream Component.	Read/Write
255.20	AR – Btu Stream Component.	Read/Write
255.21	AIR – Btu Stream Component.	Read/Write
255.22	C6PLUS – Btu Stream Component.	Read/Write
255.23	BTU – Btu Stream Component.	Read/Write
255.24	GF – Btu Stream Component.	Read/Write
255.25	NEOC5 – Btu Stream Component.	Read/Write

A.15 Therms Slave Application Registers

The Therms Slave application registers allow access to the μ FLO^{G4} data items. Usage and notes are specific to the Therms Slave application. Format for the register list is array#.register# description. The application number depends on the order of application instantiation. Actual array numbers for the Therms Slave application are offset by 100. Low order array numbers are used for the Communication application, since the LevelMaster application is derived from a Communication application. Refer to the Communication Application Register section.

A.15.1 Therms Slave Float Registers

ARRAY.REGISTER	DESCRIPTION	USAGE
100.0	N2 – Btu Stream Component.	Read/Write
100.1	CO2 – Btu Stream Component.	Read/Write
100.2	H2S – Btu Stream Component.	Read/Write
100.3	H2O – Btu Stream Component.	Read/Write
100.4	HE – Btu Stream Component.	Read/Write
100.5	C1 – Btu Stream Component.	Read/Write
100.6	C2 – Btu Stream Component.	Read/Write
100.7	C3 – Btu Stream Component.	Read/Write
100.8	NC4 – Btu Stream Component.	Read/Write
100.9	IC4 – Btu Stream Component.	Read/Write

ARRAY.REGISTER	DESCRIPTION	USAGE
100.10	NC5 – Btu Stream Component.	Read/Write
100.11	IC5 – Btu Stream Component.	Read/Write
100.12	NC6 – Btu Stream Component.	Read/Write
100.13	NC7 – Btu Stream Component.	Read/Write
100.14	NC8 – Btu Stream Component.	Read/Write
100.15	NC9 – Btu Stream Component.	Read/Write
100.16	NC10 – Btu Stream Component.	Read/Write
100.17	O2 – Btu Stream Component.	Read/Write
100.18	CO – Btu Stream Component.	Read/Write
100.19	H2 – Btu Stream Component.	Read/Write
100.20	AR – Btu Stream Component.	Read/Write
100.21	AIR – Btu Stream Component.	Read/Write
100.22	C6PLUS – Btu Stream Component.	Read/Write
100.23	BTU – Btu Stream Component.	Read/Write
100.24	GF – Btu Stream Component.	Read/Write
100.25	SGF – Btu Stream Component.	Read/Write
100.26	CPCV – Btu Stream Component.	Read/Write
100.27	VISCOSITY – Btu Stream Component.	Read/Write
100.28	DENSITY – Btu Stream Component.	Read/Write
100.29	FT – Btu Stream Component.	Read/Write
100.30	FP – Btu Stream Component.	Read/Write
100.31	C7PLUS – Btu Stream Component.	Read/Write
100.32	C8PLUS – Btu Stream Component.	Read/Write
100.33	H2OCONTENT – Btu Stream Component.	Read/Write
100.34	H2OBIAS – Btu Stream Component.	Read/Write
100.35	EOAXMAP – Btu Stream Component.	Read/Write
100.36	NEOC5 – Btu Stream Component.	Read/Write
100.37	C3PRIME – Btu Stream Component.	Read/Write
100.38	C4PLUS – Btu Stream Component.	Read/Write
100.39	SATBTU – Btu Stream Component.	Read/Write
100.40	Z – Btu Stream Component.	Read/Write
100.41	WOBBE – Btu Stream Component.	Read/Write
100.42	STREAM NUMBER.	Read/Write
100.43	STREAM TIME.	Read/Write

A.15.2 Therms Slave String Registers

ARRAY.REGISTER	DESCRIPTION	USAGE
101.0	String formatted stream time	Read

A.15.3 Therms Slave Int32 Registers

ARRAY.REGISTER	DESCRIPTION	USAGE
102.0	New Data flag Stream1	Read
102.1	New Data flag Stream2	Read
102.2	New Data flag Stream3	Read
102.3	New Data flag Stream4	Read

A.15.4 Therms Slave Stream 1 Float Registers

ARRAY.REGISTER	DESCRIPTION	USAGE
251.0	N2 – Btu Stream Component.	Read/Write
251.1	CO2 – Btu Stream Component.	Read/Write
251.2	H2S – Btu Stream Component.	Read/Write
251.3	H2O – Btu Stream Component.	Read/Write
251.4	HE – Btu Stream Component.	Read/Write
251.5	C1 – Btu Stream Component.	Read/Write
251.6	C2 – Btu Stream Component.	Read/Write
251.7	C3 – Btu Stream Component.	Read/Write
251.8	NC4 – Btu Stream Component.	Read/Write
251.9	IC4 – Btu Stream Component.	Read/Write
251.10	NC5 – Btu Stream Component.	Read/Write
251.11	IC5 – Btu Stream Component.	Read/Write
251.12	NC6 – Btu Stream Component.	Read/Write
251.13	NC7 – Btu Stream Component.	Read/Write
251.14	NC8 – Btu Stream Component.	Read/Write
251.15	NC9 – Btu Stream Component.	Read/Write
251.16	NC10 – Btu Stream Component.	Read/Write
251.17	O2 – Btu Stream Component.	Read/Write
251.18	CO – Btu Stream Component.	Read/Write
251.19	H2 – Btu Stream Component.	Read/Write
251.20	AR – Btu Stream Component.	Read/Write
251.21	AIR – Btu Stream Component.	Read/Write
251.22	C6PLUS – Btu Stream Component.	Read/Write
251.23	BTU – Btu Stream Component.	Read/Write

ARRAY.REGISTER	DESCRIPTION	USAGE
251.24	GF – Btu Stream Component.	Read/Write
251.25	NEOC5 – Btu Stream Component.	Read/Write

A.15.5 Therms Slave Stream 2 Float Registers

ARRAY.REGISTER	DESCRIPTION	USAGE
252.0	N2 – Btu Stream Component.	Read/Write
252.1	CO2 – Btu Stream Component.	Read/Write
252.2	H2S – Btu Stream Component.	Read/Write
252.3	H2O – Btu Stream Component.	Read/Write
252.4	HE – Btu Stream Component.	Read/Write
252.5	C1 – Btu Stream Component.	Read/Write
252.6	C2 – Btu Stream Component.	Read/Write
252.7	C3 – Btu Stream Component.	Read/Write
252.8	NC4 – Btu Stream Component.	Read/Write
252.9	IC4 – Btu Stream Component.	Read/Write
252.10	NC5 – Btu Stream Component.	Read/Write
252.11	IC5 – Btu Stream Component.	Read/Write
252.12	NC6 – Btu Stream Component.	Read/Write
252.13	NC7 – Btu Stream Component.	Read/Write
252.14	NC8 – Btu Stream Component.	Read/Write
252.15	NC9 – Btu Stream Component.	Read/Write
252.16	NC10 – Btu Stream Component.	Read/Write
252.17	O2 – Btu Stream Component.	Read/Write
252.18	CO – Btu Stream Component.	Read/Write
252.19	H2 – Btu Stream Component.	Read/Write
252.20	AR – Btu Stream Component.	Read/Write
252.21	AIR – Btu Stream Component.	Read/Write
252.22	C6PLUS – Btu Stream Component.	Read/Write
252.23	BTU – Btu Stream Component.	Read/Write
252.24	GF – Btu Stream Component.	Read/Write
252.25	NEOC5 – Btu Stream Component.	Read/Write

A.15.6 Therms Slave Stream 3 Float Registers

ARRAY.REGISTER	DESCRIPTION	USAGE
253.0	N2 – Btu Stream Component.	Read/Write
253.1	CO2 – Btu Stream Component.	Read/Write

253.2	H2S – Btu Stream Component.	Read/Write
253.3	H2O – Btu Stream Component.	Read/Write
253.4	HE – Btu Stream Component.	Read/Write
253.5	C1 – Btu Stream Component.	Read/Write
253.6	C2 – Btu Stream Component.	Read/Write
253.7	C3 – Btu Stream Component.	Read/Write
253.8	NC4 – Btu Stream Component.	Read/Write
253.9	IC4 – Btu Stream Component.	Read/Write
253.10	NC5 – Btu Stream Component.	Read/Write
253.11	IC5 – Btu Stream Component.	Read/Write
253.12	NC6 – Btu Stream Component.	Read/Write
253.13	NC7 – Btu Stream Component.	Read/Write
253.14	NC8 – Btu Stream Component.	Read/Write
253.15	NC9 – Btu Stream Component.	Read/Write
253.16	NC10 – Btu Stream Component.	Read/Write
253.17	O2 – Btu Stream Component.	Read/Write
253.18	CO – Btu Stream Component.	Read/Write
253.19	H2 – Btu Stream Component.	Read/Write
253.20	AR – Btu Stream Component.	Read/Write
253.21	AIR – Btu Stream Component.	Read/Write
253.22	C6PLUS – Btu Stream Component.	Read/Write
253.23	BTU – Btu Stream Component.	Read/Write
253.24	GF – Btu Stream Component.	Read/Write
253.25	NEOC5 – Btu Stream Component.	Read/Write

A.15.7 Therms Slave Stream 4 Float Registers

ARRAY.REGISTER	DESCRIPTION	USAGE
254.0	N2 – Btu Stream Component.	Read/Write
254.1	CO2 – Btu Stream Component.	Read/Write
254.2	H2S – Btu Stream Component.	Read/Write
254.3	H2O – Btu Stream Component.	Read/Write
254.4	HE – Btu Stream Component.	Read/Write
254.5	C1 – Btu Stream Component.	Read/Write
254.6	C2 – Btu Stream Component.	Read/Write
254.7	C3 – Btu Stream Component.	Read/Write
254.8	NC4 – Btu Stream Component.	Read/Write

ARRAY.REGISTER	DESCRIPTION	USAGE
254.9	IC4 – Btu Stream Component.	Read/Write
254.10	NC5 – Btu Stream Component.	Read/Write
254.11	IC5 – Btu Stream Component.	Read/Write
254.12	NC6 – Btu Stream Component.	Read/Write
254.13	NC7 – Btu Stream Component.	Read/Write
254.14	NC8 – Btu Stream Component.	Read/Write
254.15	NC9 – Btu Stream Component.	Read/Write
254.16	NC10 – Btu Stream Component.	Read/Write
254.17	O2 – Btu Stream Component.	Read/Write
254.18	CO – Btu Stream Component.	Read/Write
254.19	H2 – Btu Stream Component.	Read/Write
254.20	AR – Btu Stream Component.	Read/Write
254.21	AIR – Btu Stream Component.	Read/Write
254.22	C6PLUS – Btu Stream Component.	Read/Write
254.23	BTU – Btu Stream Component.	Read/Write
254.24	GF – Btu Stream Component.	Read/Write
254.25	NEOC5 – Btu Stream Component.	Read/Write

A.15.8 Therms Slave Analysis Trend File

ARRAY.REGISTER	DESCRIPTION	USAGE
255.0	N2 – Btu Stream Component.	Read/Write
255.1	CO2 – Btu Stream Component.	Read/Write
255.2	H2S – Btu Stream Component.	Read/Write
255.3	H2O – Btu Stream Component.	Read/Write
255.4	HE – Btu Stream Component.	Read/Write
255.5	C1 – Btu Stream Component.	Read/Write
255.6	C2 – Btu Stream Component.	Read/Write
255.7	C3 – Btu Stream Component.	Read/Write
255.8	NC4 – Btu Stream Component.	Read/Write
255.9	IC4 – Btu Stream Component.	Read/Write
255.10	NC5 – Btu Stream Component.	Read/Write
255.11	IC5 – Btu Stream Component.	Read/Write
255.12	NC6 – Btu Stream Component.	Read/Write
255.13	NC7 – Btu Stream Component.	Read/Write
255.14	NC8 – Btu Stream Component.	Read/Write

ARRAY.REGISTER	DESCRIPTION	USAGE
255.15	NC9 – Btu Stream Component.	Read/Write
255.16	NC10 – Btu Stream Component.	Read/Write
255.17	O2 – Btu Stream Component.	Read/Write
255.18	CO – Btu Stream Component.	Read/Write
255.19	H2 – Btu Stream Component.	Read/Write
255.20	AR – Btu Stream Component.	Read/Write
255.21	AIR – Btu Stream Component.	Read/Write
255.22	C6PLUS – Btu Stream Component.	Read/Write
255.23	BTU – Btu Stream Component.	Read/Write
255.24	GF – Btu Stream Component.	Read/Write
255.25	NEOC5 – Btu Stream Component.	Read/Write

Contact us:

ABB Inc., Measurement & Analytics

Quotes: totalflow.inquiry@us.abb.com

Orders: totalflow.order@us.abb.com

Training: totalflow.training@us.abb.com

Support: upstream.support@us.abb.com

+1 800 442 3097 (opt. 2)

www.abb.com/upstream

Main Office - Bartlesville
7051 Industrial Blvd
Bartlesville, OK 74006
Ph: +1 918 338 4888

Kansas Office - Liberal
2705 Centennial Blvd
Liberal, KS 67901
Ph: +1 620 626 4350

Texas Office – Odessa
8007 East Business 20
Odessa, TX 79765
Ph: +1 432 272 1173

Texas Office - Houston
3700 W. Sam Houston
Parkway S., Suite 600
Houston, TX 77042
Ph: +1 713 587 8000

California Office -
Bakersfield
4300 Stine Road
Suite 405-407
Bakersfield, CA 93313
Ph: +1 661 833 2030

Texas Office –
Pleasanton
150 Eagle Ford Road
Pleasanton, TX 78064
Ph: +1 830 569 8062

—
We reserve the right to make technical changes or modify the contents of this document without prior notice. With regard to purchase orders, the agreed particulars shall prevail. ABB does not accept any responsibility whatsoever for potential errors or possible lack of information in this document.

We reserve all rights in this document and in the subject matter and illustrations contained therein. Any reproduction, disclosure to third parties or utilization of its contents - in whole or in parts – is forbidden without prior written consent of ABB.

Copyright© 2018 ABB all rights reserved