

OPTIONS FOR ABB DRIVES

F50-21 safety functions module

User's manual



List of related manuals

Drive hardware manuals and guides

	Code (English)
Drive/converter/inverter safety instructions	3AXD50000037978
ACS880-01 hardware manual	3AUA0000078093
ACS880-04 hardware manual	3AUA0000128301
ACS880-04 single drive module packages hardware manual	3AUA0000138495
ACS880-14 and -34 single drive module packages hardware manual	3AXD50000022021
ACS880-04XT drive modules (500 to 1200 kW) hardware manual	3AXD50000025169
ACS880-07 (45 to 710 kW) hardware manual	3AUA0000105718
ACS880-07 (560 to 2800 kW) hardware manual	3AUA0000143261
ACS880-07LC drives hardware manual	3AXD50000569786
ACS880-11 drives hardware manual	3AXD50000045932
ACS880-31 drives hardware manual	3AXD50000045933
ACS880-14 drive modules hardware manual	3AXD50000035160
ACS880-34 drive modules hardware manual	3AXD50000035191
ACS880-17 (160 to 3200 kW) hardware manual	3AXD50000020436
ACS880-37 (160 to 3200 kW) hardware manual	3AXD50000020437
ACS880-17 (45 ... 400 kW) hardware manual	3AXD50000035158
ACS880-37 (45 ... 400 kW) hardware manual	3AXD50000035159
ACS880-17LC drives hardware manual	3AXD50000250295
ACS880-37LC drives hardware manual	3AXD50000251407
ACS880-104 inverter modules hardware manual	3AUA0000104271
ACS880-107 inverter units hardware manual	3AUA0000102519
ACS880-104LC inverter modules hardware manual	3AXD50000045610
ACS880-107LC inverter units hardware manual	3AXD50000196111
DCS880 hardware manual	3ADW000462

Drive firmware manuals and guides

ACS880 primary control program firmware manual	3AUA0000085967
DCS880 firmware manual	3ADW000474

Option manuals and guides

ACX-AP-x assistant control panels user's manual	3AUA0000085685
FSO-21 safety functions module user's manual	3AXD50000015614
FSE-31 pulse encoder interface module user's manual	3AXD50000016597
FENA-01/-11/-21 Ethernet adapter module user's manual	3AUA0000093568
FPNO-21 PROFINET adapter module user's manual	3AXD50000158614

Drive PC tool manuals

Drive Composer start-up and maintenance PC tool user's manual	3AUA0000094606
Functional safety design tool user's manual	3AXD10000102417

General safety guides

Functional safety, Technical guide No. 10	3AUA0000048753
ABB Safety information and solutions	www.abb.com/safety

Safety system manuals

AC500-S Safety User Manual	3ADR025091M0207
AC500 Control Builder PS501 Complete English documentation	3ADR025078M0204
DCS880 supplement for functional safety	3ADW000452

User's manual

FSO-21 safety functions module

Table of contents



1. Safety instructions



8. Installation



12. Start-up



Table of contents

1. Safety instructions

Contents of this chapter	13
Use of warnings	13
Electrical safety precautions	14

2. Introduction to the manual

Contents of this chapter	17
Exclusion of liability	17
Applicability	17
Compatible products	18
ACS880 drives and option modules	18
DCS880 drives and option modules	18
Controller stations	19
Tools	19
Supported safety functions	20
Target audience	20
Purpose of the manual	20
Contents	20
Recommended reading	22
Terms and abbreviations	22
Certificates	29



3. Safety information and considerations

Contents of this chapter	31
Use of safety functions	31
Meeting the requirements of the Machinery Directive	32
Responsibilities	32
Intentional misuse	32
Safety-related parts	32
Limitations of Safe torque off (STO) function	32
Proof testing	33
Safety separation	33
ACS880 drives with separate inverter and supply units	33

4. Overview

Contents of this chapter	35
Intended use of the FSO module	35
System description	36
FSO module and safety system components	36
FSO module version handling	37
Layout	38
Connections	39

6 Table of contents

Type designation label	39
Operational characteristics	40
Response times	40
FSO diagnostics	41
I/O	41
Acknowledgement	42
Safety encoders	43
Safe position	44
Motor speed feedback	44
Overview of safety functions	49
Safe torque off (STO)	49
Safe stop 1 (SS1)	49
Safe stop emergency (SSE)	49
Safe brake control (SBC)	50
Safely-limited speed (SLS)	51
Variable Safely-limited speed (SLS)	51
Safe maximum speed (SMS)	51
Prevention of unexpected start-up (POUS)	51
Safe speed monitoring (SSM)	51
Safe direction (SDI)	52
Safe acceleration range (SAR)	52

5. Safety functions

Contents of this chapter	53
General	54
Safety function request	54
Acknowledgement methods	55
DC magnetization and drive start modes	56
Ramp monitoring	57
Safety function indications	58
FSO modes	60
FSO states	61
Transitions between FSO modes and states	62
Cascade	63
Mute time feature	65
Safe torque off (STO)	68
STO function	69
SBC after STO	72
SBC before STO	75
STO with speed limit activated SBC	78
Safe stop 1 (SS1)	80
SS1 with time monitoring (SS1-t)	81
SS1 with ramp monitoring (SS1-r)	85
SS1 with speed limit activated SBC	89
SS1 with speed limit activated SBC, SBC before STO	97
SS1 ramp functions when drive modulation is lost	105
Safe stop emergency (SSE)	107
SSE with immediate STO	108
SSE with immediate STO, SBC after STO	110
SSE with immediate STO, SBC before STO	113



SSE with immediate STO, with speed limit activated SBC	116
SSE with time monitoring	117
SSE with ramp monitoring	121
SSE with speed limit activated SBC	125
SSE with speed limit activated SBC, SBC before STO	133
SSE when drive modulation is lost during deceleration ramp	140
Safely-limited speed (SLS)	141
SLS with speed below monitored speed	142
SLS with time monitoring and speed above monitored speed	144
SLS with ramp monitoring and speed above monitored speed	146
SLS reaction when modulation is lost during deceleration ramp, with ramp monitoring	148
SLS reaction when modulation is lost during deceleration ramp, with time monitoring	158
FSO boot behavior with SLS active	167
SLS trip limit hits	168
Variable Safely-limited speed (SLS)	173
Variable SLS with time monitoring	174
Variable SLS with ramp monitoring	176
Safe maximum speed (SMS)	178
SMS function, version 1	179
SMS function, version 2	180
Prevention of unexpected start-up (POUS)	181
Safe speed monitor (SSM)	183
SSM with a safe speed estimate	185
Safe direction (SDI)	187
SDI with correct rotation direction	187
SDI with time monitoring	189
SDI with ramp monitoring	191
SDI trip limit hits	193
Priorities between safety functions	194
Dependencies between safety functions	194



6. PROFIsafe

Contents of this chapter	197
Introduction	197
System description	198
Required components	198
Tools	198
System overview	199
Remote I/O control	201
FSO module passivation	201
PROFIsafe description	202
PROFIsafe message format	202
FSO PROFIsafe profiles	203
FSO module modes and states	214
PROFIsafe response time	226
PROFIsafe watchdog time	228
Installation	230
Configuration	231
Configuring the FB module	231
Configuring the FSO module	232

8 Table of contents

Configuring the safety PLC	233
Downloading the GSD file	233
Configuring the ABB AC500-S Safety PLC	233
Configuring the Siemens SIMATIC Fail-safe S7 PLC	251
Configuring Siemens S7-1200 PLC with TIA14	266
Fault tracing	282
Reading diagnostic messages	282
Diagnostic messages related to F-Parameters	285
Typical communication errors	286

7. Planning for installation

Contents of this chapter	289
Requirements for designers and installers	289
Mechanical installation	289
Installation site	289
Electrical installation	290
General requirements	290
Connections	290
STO cable and data cable between FSO module and drive	291
Power supply connection/cables	291
Power supply for the FSE module and safety encoders	291
Ensuring the EMC compatibility	291
Selecting control cables	292
Routing the cables	292
Standard function and wiring examples	293

8. Installation

Contents of this chapter	297
Unpacking	298
Examining the delivery	298
Mechanical installation	299
Installing the module onto a BCU control unit	299
Installing the module onto a ZCU control unit	300
Electrical installation	301
Terminals	301
Connection procedure	302

9. Installation checklists

Contents of this chapter	307
Checklists	307

10. Configuration

Contents of this chapter	309
Competence	309
Password	309
Configuring the FSO module	310
Overview - safety system configuring process	310
FSO configuring procedure	312



Configuring general settings	314
How to configure general settings	314
Configuring the safety encoder interface	315
How to configure the safety encoder interface	315
Diagnostics of FSE-31 encoder interface module	317
Disabling the safety encoder interface	318
Configuring the FSO for FSE or encoder failure situations	319
Encoder diagnostics failure reaction	319
Configuring the safety fieldbus communication	320
How to configure the safety communication with PROFIsafe	320
Configuring I/O	321
How to configure I/O	321
How to configure a cascaded system	324
How to configure safety relays	328
Configuring SBC	329
How to configure the SBC in the STO function	331
How to configure the SBC in the SS1 function	332
Configuring STO	333
How to configure STO	333
How to configure SBC after STO	335
How to configure SBC before STO	337
How to configure STO with speed limit activated SBC	339
Configuring SS1	342
How to configure SS1 with time monitoring (SS1-t)	342
How to configure SS1 with ramp monitoring (SS1-r)	344
How to configure SS1 with speed limit activated SBC	345
How to configure SS1 with speed limit activated SBC, SBC before STO	349
Related safety functions	352
Configuring SSE	353
How to configure SSE with immediate STO	353
How to configure SSE with immediate STO, SBC after or before STO	355
How to configure SSE with immediate STO with speed limit activated SBC	355
How to configure SSE with time monitoring	356
How to configure SSE with ramp monitoring	357
How to configure SSE with speed limit activated SBC	358
How to configure SSE with speed limit activated SBC, SBC before STO	362
Related safety functions	362
Configuring SAR	363
How to configure SARn	363
Configuring SLS	364
How to configure SLSn with time monitoring	364
How to configure SLSn with ramp monitoring	366
Related safety functions	367
Configuring Variable SLS	368
How to configure Variable SLS with time monitoring	368
How to configure Variable SLS with ramp monitoring	370
Defining the scaled SLS4 limit and SLS4 trip limits	372
Related safety functions	375
Configuring SMS	376
How to configure SMS, version 1	376
How to configure SMS, version 2	377



10 Table of contents

Related safety functions	377
Configuring POUS	378
How to configure POUS	378
How to configure SLS function behavior when drive modulation is lost	378
How to configure SLSn with time monitoring if drive modulation is lost during SLS deceleration ramp	379
How to configure SLSn with ramp monitoring if drive modulation is lost during SLS deceleration ramp	385
Configuring SSM	389
How to configure SSM	390
Configuring SDI	391
How to configure SDI with time monitoring	392
How to configure SDI with ramp monitoring	393
Related safety functions	394
Configuring mute times	395
How to determine values for mute time parameters	395
How to configure limit hit situations	396
How to configure mute time for zero speed detection	399
How to configure mute time for SBC speed limit detection	400
How to configure mute time for monitoring start	401



11. Parameters

Contents of this chapter	403
FSO-21 parameters	403
Status and control words	451

12. Start-up

Contents of this chapter	457
Safety considerations	457
Checks	458

13. Verification and validation

Contents of this chapter	459
Verifying the achieved SIL/PL level	459
Purpose of the validation testing	459
Preconditions for validation testing	460
Validation procedure	460
General	460
Validation test reports	461
Competence	461
Tools	461
Validation of the PROFIsafe connection	462
Validation of the safety encoder interface	463
Validation of safety functions	466
Validation of redundant inputs	466
Validation of safety I/O's	467
Validation of the general settings	467
Validation of the STO function	468

Validation of the SBC function	470
Validation of the SSE function	472
Validation of the SS1 function	475
Validation of the SLS functions	477
Validation of the variable SLS function	479
Validation of the SMS functions	481
Validation of the POUS function	483
Validation of the SSM functions	484
Validation of the SDI function	485
Validation of the cascaded safety function	488
Proof test intervals during operation	489
Residual risks	489

14. Fault tracing

Contents of this chapter	491
Status LEDs	491
Event types	492
Event code decoding with Drive Composer pro PC tool	492
Faults, warnings and events	493
User-selectable events for function requests	503
User-selectable events for limit hits and special events	503
User-selectable events for safety fieldbus failures	506
Auxiliary codes	506
FSO recovery	506
External fault	506
Internal fault	507
Reporting problems and failures	507



15. Maintenance

Contents of this chapter	509
Planning	509
Tools	509
Component replacement in the safety circuit	510
Before component replacement	510
Replacing the FSO module	510
Reinstalling the FSO module to another drive	511
Replacing the control unit of the drive	511
Replacing the memory unit or updating the firmware of the drive	511
Replacing a power unit, or its circuit boards or wirings	511
Replacing the FB module in PROFIsafe network	512
Replacing the FSE module	512
Replacing the safety encoder	512
Start-up and validation test	512
Factory reset	513
Drive control board boot	514
Updates	514
Proof tests	514
Decommissioning	514

16. Technical data

Contents of this chapter	517
Electrical data	517
PROFIsafe and related network devices	517
Control connection data	518
Terminal and cable entry data for the control cables	518
STO cable and data cable between FSO module and drive	519
Tightening torques	519
Size and weight	519
Cooling	519
Compatible motor types	520
Speed estimation	520
Ambient conditions	520
Safety functions	521
Safety data	522
General	522
Basic safety data	524
FSE-31 pulse encoder interface module	525
FSO safety calculations guide (without PROFIsafe)	526
FSO safety calculations guide (with PROFIsafe)	531
Relevant failure modes	531
Response times	532
Ordering information	534
Related standards and directives	535

**17. Dimension drawings****Further information**

1

Safety instructions

Contents of this chapter

The chapter contains the warning symbols used in this manual and the safety instructions which you must obey when you install or connect an option module to a drive or inverter. If you ignore the safety instructions, injury, death or damage can occur. Read this chapter before you start the installation.



Use of warnings

Warnings tell you about conditions which can cause injury or death, or damage to the equipment. They also tell you how to prevent the danger. The manual uses these warning symbols:



Electricity warning tells you about hazards from electricity which can cause injury or death, or damage to the equipment.



General warning tells you about conditions, other than those caused by electricity, which can cause injury or death, or damage to the equipment.

Electrical safety precautions

These electrical safety precautions are for all personnel who do work on the drive, motor cable or motor.

This manual does not give detailed information for disconnecting and isolating all drive types. Refer also to the drive or inverter unit hardware manual.



WARNING! Obey these instructions and the safety instructions of the drive. If you ignore them, injury or death, or damage to the equipment can occur. If you are not a qualified electrical professional, do not do installation or maintenance work. Do these steps before you start installation or maintenance work.

1. Clearly identify the work location and equipment.
2. Disconnect all possible voltage sources. Make sure that re-connection is not possible. Lock out and tag out.
 - Open the main disconnecting device of the drive.
 - If you have a permanent magnet motor connected to the drive, disconnect the motor from the drive with a safety switch or by other means.
 - Disconnect all dangerous external voltages from the control circuits.
 - After you disconnect power from the drive, always wait 5 minutes to let the intermediate circuit capacitors discharge before you continue.
3. Protect any other energized parts in the work location against contact.
4. Take special precautions when close to bare conductors.
5. Measure that the installation is de-energized. Use a quality voltage tester.
 - Before and after measuring the installation, verify the operation of the voltage tester on a known voltage source.
 - ACS880 drives:
 - Make sure that the voltage between the drive input power terminals (L1, L2, L3) and the grounding (PE) busbar is zero.
 - Make sure that the voltage between the drive output terminals (T1/U, T2/V, T3/W) and the grounding (PE) busbar is zero.
 - Make sure that the voltage between the drive DC terminals and the grounding (PE) busbar is zero.
 - DCS880 drives:
 - Make sure that the voltage between drive input phases U1, V1 and W1 and the frame is zero.
 - Make sure that the voltage between terminals C+ and D- and the frame is zero.



6. Install temporary grounding as required by the local regulations.
7. Ask the person in control of the electrical installation work for a permit to work.







Introduction to the manual

Contents of this chapter

This chapter states exclusion of liability and describes the applicability, compatible products, supported safety functions, target audience and purpose of the manual.

The chapter also lists contents of this manual, recommended reading as well as related standards and directives, and explains used definitions, terms and abbreviations. The safety certificate is included at the end of the chapter.

Exclusion of liability

This manual is an informative aid only. It contains information needed to use the FSO-21 safety functions module when implementing safety systems. The information and examples given are for general use only. They do not describe all the necessary details for implementing a safety system. The manufacturer of the machinery always remains ultimately responsible for the product safety and compliance with applicable laws. ABB does not accept any liability for direct or indirect injury or damage caused by the information contained in this document. ABB hereby disclaims all liabilities that may result from this document.

Do not open the FSO module, otherwise the safety classification will become invalid and the warranty cease to be in effect.

Applicability

This manual applies to the FSO-21 safety functions module, revision J.

Compatible products

Check the compatibility of the earlier versions with your local ABB representative. See also section [FSO module version handling](#) on page 37.

■ ACS880 drives and option modules

- ACS880 series without “No FSO support” sticker
- ACS880 primary control program: version 2.21 or later
- FSE-31 pulse encoder interface module: revision D or later
- FENA-21 Ethernet adapter module: version 3.05 or later
- FPNO-21 PROFINET fieldbus adapter module: version 1.00 or later

Application control programs

FSO-21 behavior is independent from application control program, thus all application control programs are supported by FSO-21. Example applications:

- Machinery control program v2.40 or later
- Crane control program v2.1 or later
- Tower crane control program v1.0 or later
- Winch control program v1.0 or later
- Winder control program v1.10 or later
- PCP/ESP control program (+N5200) v1.1 or later
- PCP/ESP control program SynRM v1.1.1.0 or later
- Spinning control program v1.0 or later
- Rod pump control program v1.0 or later

Note: If you want to use the possibility to switch the motor speed feedback between encoder and estimate, ACS880 primary control program version 2.51 (or later) and FSE-31 revision F (or later) are required. See section [Motor speed feedback](#) on page 44.

■ DCS880 drives and option modules

- DCS880 drive modules
- DCS880 firmware, version 2.07 or later
- FSE-31 pulse encoder interface module: revision D or later
- FENA-21 Ethernet adapter module: version 3.11 or later
- FPNO-21 PROFINET fieldbus adapter module: version 1.00 or later

Note that there are fundamental differences how a DCS880 drive operates when compared to an ACS880 drive. This leads to the following limitations:

- STO takes 500 ms to be achieved in DCS880 drives. Further, a secondary switching device (i.e. AC-breaker, medium voltage breaker or DC-breaker) must
-

be installed to disconnect the drive from the power grid or from the motor in the rare case of an internal STO failure. For further information, refer to *Supplement for functional safety* (3ADW000452R).

- Safe speed estimate: It is not possible to use the safe speed estimate with a DCS880 converter. Thus, the FSO-21 module cannot switch to safe speed estimate in case of an encoder failure but activates the STO function instead.
- For the same reason, speed-dependent safety functions are not available without a safety encoder (for details see section [Safety encoders](#) on page 43). It is recommended to always use an FSE-31 module with a safety encoder together with the FSO-21 module.
- Sections in this manual which describe the safe speed estimate or sections which refer to drive modulating are not applicable to DCS880.

■ Controller stations

For example the following controller stations are supported. Check the compatibility of the controller station in its manual.

- ABB AC500-S Safety PLC. For more information, see *AC500-S Safety User Manual* (3ADR025091M0207 [English])
- Siemens SIMATIC Fail-safe S7 PLC

■ Tools

- Drive Composer pro PC tool: version 1.8 or later

Note: This manual applies to the Drive Composer pro PC tool versions until 1.12. If you use a later version, the menus and button names can differ from the ones used in this manual. For more information, see the documentation of the tool.



WARNING! ACS880 drives equipped with the label “No FSO support” are not compatible with FSO-21. Do not use this combination.

Supported safety functions

This manual provides instructions for creating the following safety functions (according to EN/IEC 61800-5-2) for the ACS880/DCS880 drives:

- Safe torque off (STO) – standard feature in the ACS880/DCS880 drives, see page [68](#)
- Safe brake control (SBC), see page [50](#)
- Safe stop 1 (SS1), see page [80](#)
- Safely-limited speed (SLS), see page [141](#)
- Variable Safely-limited speed (SLS), with PROFIsafe only, see page [173](#).
- Safe speed monitor (SSM), see page [183](#).
- Safe direction (SDI), see page [187](#).

Additional safety functions (not specified in EN/IEC 61800-5-2):

- Safe stop emergency (SSE), see page [107](#)
- Safe maximum speed (SMS), see page [178](#)
- Prevention of unexpected start-up (POUS), see page [181](#).

Target audience

The manual is intended for qualified persons who design the safety application, plan the installation as well as install and commission the safety application. Read the manual before starting work on the safety application. You must know the fundamentals of safety technology, electricity, wiring, electrical components and electrical schematic symbols.

Purpose of the manual

The manual explains how to install the FSO safety functions module and configure and commission the supported safety functions. It describes how to meet and maintain safety life cycle requirements of the FSO module to ensure required safety performance and specified safety integrity.

Drive-specific technical, configuration and installation details are in the drive hardware manual (see [List of related manuals](#) on page [2](#)).

Contents

Chapter [Safety instructions](#) (page [13](#)) explains the usage of warning symbols in this manual and the safety instructions which you must obey when you install or connect an option module to a drive or inverter.

Chapter [Introduction to the manual](#) (this chapter, page [17](#)) states exclusion of liability and describes the applicability, compatible products, supported safety functions, target audience and purpose of the manual.

It also lists contents of this manual and recommended reading and explains used definitions, terms and abbreviations. The safety certificate is included at the end of the chapter.

Chapter [Safety information and considerations](#) (page 31) contains general safety considerations and information to be taken into account when applying the FSO safety functions.

Chapter [Overview](#) (page 35) briefly describes the FSO module with safety system components as well as the FSO layout, connections, type designation label and operational characteristics.

Chapter [Safety functions](#) (page 53) describes how the safety functions of the FSO module operate.

Chapter [PROFIsafe](#) (page 197) describes the safety system when the FSO module is connected to a safety PLC through a fieldbus (FB) module using the PROFIsafe profile of PROFINET. It describes the FSO module states and transitions and the contents of the PROFIsafe messages. The chapter also includes installation instructions, configuration instructions for the ABB AC500-S Safety PLC and Siemens SIMATIC Fail-safe S7 PLC as well as fault tracing tips.

Chapter [Planning for installation](#) (page 289) gives instructions and references to instructions in other manuals for planning the safety system installation, as well as the requirements for installation in the applicable safety standards.

Chapter [Installation](#) (page 297) gives examples of how to connect the FSO module to the ACS880/DCS880.

Chapter [Installation checklists](#) (page 307) contains a checklist for checking the mechanical and electrical installation of the FSO module and refers to common cause failure checklists in standards.

Chapter [Configuration](#) (page 309) describes the password usage, outlines the configuration process and gives examples of how to configure the FSO module to implement the safety functions described in chapter [Safety functions](#).

Chapter [Parameters](#) (page 403) lists the FSO parameters.

Chapter [Start-up](#) (page 457) describes the general precautions to be taken before starting up the safety system for the first time.

Chapter [Verification and validation](#) (page 459) describes verification and validation procedures of the implemented safety functions.

Chapter [Fault tracing](#) (page 491) describes the status LEDs and provides generic diagnostics, troubleshooting and fault recovery tips for FSO-related faults.

Chapter [Maintenance](#) (page 509) explains the replacement of the FSO and FSE modules in case of a module failure, gives instructions for reinstalling the FSO module to another drive and updating the firmware of the drive where the FSO is installed. It also gives instructions for the replacement of the FB module, FSO factory reset, safety system update and decommissioning as well as proof tests.

Chapter [Technical data](#) (page 517) contains the technical specifications of the FSO module, for example, electrical data, sizes and safety data. It also lists related standards and directives.

Chapter [Dimension drawings](#) (page 537) shows the dimension drawings of the FSO module.

Recommended reading

This manual is based on the following standards. It is recommended that you are familiar with these standards before implementing safety-related systems.

- EN/IEC 61800-5-2: *Adjustable speed electrical power drive systems – Part 5-2: Safety requirements – Functional*. (Includes safety function definitions.)
- EN ISO 13849-1: *Safety of machinery – Safety-related parts of control systems – Part 1: General principles for design*
- EN/IEC 62061: *Safety of machinery – Functional safety of safety-related electrical, electronic and programmable electronic control systems*
- EN 60204-1: *Safety of machinery – Electrical equipment of machines – Part 1: General requirements*.
- *PROFIsafe System Description – Safety Technology and Application. Version November 2010. Order Number 4.342.*

Before starting the implementation of safety-related systems, it is highly recommended to read and understand the following manuals, which will also be referred to in the later chapters of this manual.

- *Functional safety; Technical guide No. 10* (3AUA0000048753 [English])
- firmware and hardware manuals of the drive.

For a complete list of related standards and directives, see section [Related standards and directives](#) on page 535.

Terms and abbreviations

The terms and abbreviations used in this manual are defined in the table below.

Term / Abbreviation	Description
Acknowledgement	Deactivates the active safety functions which have been completed and are without active function request. See section Acknowledgement methods on page 55. See also term Reset on page 26.
AWG	American wire gauge

Term / Abbreviation	Description
B _{10d}	Number of cycles until 10% of the components fail dangerously (for pneumatic and electromechanical components). (EN ISO 13849-1)
BCU	Type of control unit
Black channel	Communication channel that is not safe as it has not been designed and/or validated according to IEC 61508. The reliability of the connection can be secured with an additional security protocol, for example PROFIsafe, on top of the black channel.
Cat.	Classification of the safety-related parts of a control system. The categories are: B, 1, 2, 3 and 4. (EN ISO 13849-1)
CCF	Common cause failure (EN ISO 13849-1)
Common cause failure (CCF)	Failure, which is the result of one or more events, causing coincident failures of two or more separate channels in a multiple channel (redundant architecture) subsystem, leading to failure of a Safety related electronic control function (SRCF).
Communication module	Communication module is a name for a device (eg, a fieldbus adapter) through which the drive is connected to an external communication network (eg, a fieldbus). The communication with the module is activated with a drive parameter.
Controller	Control system with bus initiative (master). In PROFINET IO terminology, controller stations are also called active stations.
Control word	16-bit word from controller to device with bit-coded control signals (sometimes called the Command word).
CRC	Cyclic redundancy check
Cyclic communication	Communication in which parameter/process data objects are sent cyclically at predefined intervals
DAT	Device acknowledgement time
DC	Diagnostic coverage (%) (EN ISO 13849-1), Direct current
Device	Passive bus participant. In PROFINET IO terminology, device stations (or slaves) are also called passive stations. Also referred to as nodes.
DI	Digital input
DO	Digital output
E-stop	Emergency stop
ELV	Extra-low voltage
EMC	Electromagnetic compatibility
External active load	Load that has the capability to accelerate the speed of the motor, for example, gravity or spring based load.
Factory reset	See Reset
Fail-safe mode	The FSO module has activated the drive STO function as a result of an error (in some cases, after a delay). To exit this mode and continue normal operation, reboot the FSO module.

Term / Abbreviation	Description
FbEq16	16-bit fieldbus equivalent: The scaling between the value shown on the panel and the integer used in communication when a 16-bit value is selected for transmission to an external system.
FbEq32	32-bit fieldbus equivalent: The scaling between the value shown on the panel and the integer used in communication when a 32-bit value is selected for transmission to an external system.
F-Device	Device that is able to communicate using PROFIsafe, eg, the FSO module.
F-Host	Programmable logic controller (PLC) that is able to communicate using PROFIsafe.
F-Input	PROFIsafe frame user data from that is sent from the F-Device (FSO) to the F-Host (PLC).
F-Output	PROFIsafe frame user data from that is sent from the F-Host (PLC) to the F-Device (FSO).
F-Parameters	Set of PROFIsafe parameters that all PROFIsafe devices support. F-Parameters are sent from the F-Host (PLC) to the F-Device (FSO) when the PROFIsafe connection is created.
FBA	Fieldbus adapter parameter (drive parameter group 50)
FB module	Fieldbus adapter module (FPNO-21 or FENA-21)
FENA-21	Optional Ethernet adapter module for EtherNet/IP™, Modbus TCP and PROFINET IO protocols
FIT	Failure in time: 1E-9 hours. Expected failure rate of semiconductors and other electronic devices. (IEC 61508)
FPNO-21	PROFINET fieldbus adapter module
FSE-31	Pulse encoder interface module which can be used in safety applications
FSO-12	Safety functions module which does not support the use of encoders
FSO-21	Safety functions module which supports the FSE-31 module and the use of safety encoders
Functional safety	Functional safety is part of the overall safety that depends on a system or equipment operating correctly in response to its inputs.
Generator mode	Drive is taking energy from the controlled application
GND	Ground
GSD file	General Station Description file that describes the basic capabilities of a device in a specified form. PROFINET uses GSDML files which are GSD files written in XML format.
HAT	Host acknowledgement time
Hazard	Potential source of harm (physical injury, or damage to health or equipment)
HFT	Hardware fault tolerance (IEC 61508)

Term / Abbreviation	Description
hi-Z state	In digital outputs, the signal is neither driven to a logical high nor low level. It is "floating".
HTL	High-threshold logic
IGBT	Insulated gate bipolar transistor
Internal fault	A fault which is detected by FSO module's internal diagnostics. When an internal fault is detected, the FSO goes into fail-safe mode, activates drive STO, and creates a fault to the drive.
I/O	Input/output
LSB	Least significant byte
MAC address	Media access control address. A unique identifier of a network node in an communication network.
Mission time	T_M . The period of time covering the intended use of a safety function/device. After the mission time the safety device(s) must be replaced. Note that any T_M values given cannot be regarded as a guarantee or warranty. (EN ISO 13849-1).
MSB	Most significant byte
modoff	No modulation (the control of inverter IGBTs is off) Warning: 'No modulation' is <i>not</i> a safe state. To achieve a safe state, the STO function must be activated.
MTTF _D	Mean time to dangerous failure: (The total number of life units) / (the number of dangerous, undetected failures) during a particular measurement interval under stated conditions (EN ISO 13849-1)
N/A	Not applicable
NC	Normally closed. Break contact. Normally closed contacts disconnect the circuit when the relay is energized; the circuit is connected when the relay is de-energized.
NO	Normally open. Make contact. Normally open contacts connect the circuit when the relay is energized; the circuit is disconnected when the relay is de-energized.
OEM	Original equipment manufacturer
PCB	Printed circuit board
PELV	Protected extra-low voltage (IEC 60364-4-41)
PFD _{avg}	Average probability of dangerous failure on demand (IEC 61508)
PFH	Average frequency of dangerous failures per hour (IEC 61508)
PL	Performance level (a-e) (EN ISO 13849-1)
PLC	Programmable logic controller
POUS	Prevention of unexpected start-up
Power drive systems (Safety related), PDS(SR)	Adjustable speed electrical power drive system suitable for use in safety-related applications

Term / Abbreviation	Description
Profile	Adaptation of the protocol for certain application field, for example, drives.
PROFINET	An open standard for industrial communication systems that uses the Ethernet standard. Registered trademark of PROFIBUS and PROFINET International (PI) community.
PROFIsafe	An additional layer on top of the PROFINET protocol for safety-related communication. Registered trademark of PROFIBUS and PROFINET International (PI) community.
Proof test	Periodic test performed to detect dangerous hidden failures in a safety-related system so that, if necessary, a repair can restore the system to an "as new" condition or as close as practical to this condition. (IEC 61508, IEC 62061)
Protective measure	Measure intended to achieve risk reduction
PZD	Process data (<i>Prozessdaten</i>)
Reasonably foreseeable misuse	Use of a machine in a way not intended by the designer, but which may result from readily predictable human behavior
Reset	Factory reset. Clears the configuration and sets the parameters to their factory default values.
Residual risk	Risk remaining after protective measures have been taken
Response time of FSO	The internal response time of the FSO, that is, the time in which the STO control output of the FSO reacts after receiving a request. (Usually this is not the same as the time from the request to the safe state of the machine application.) See also term Safety function response time (SFRT) on page 26.
Risk	Combination of the probability of occurrence of harm and the severity of that harm
Safe state	STO activated. The STO circuit in the drive is open. Note: When the drive STO is activated in the POUS function, the FSO is in the Operational state. See also section FSO states on page 61.
Safety fieldbus	Communication system used in safety-related applications. In the safety system described in this manual, safe communication is secured with the PROFIsafe application layer. See also term PROFIsafe on page 26.
Safety function	Function, with a specified safety performance, which is intended to maintain the safe condition of the installation or prevent hazardous conditions arising at the installation. Example: Safe torque off (STO)
Safety function response time (SFRT)	Worst-case elapsed time following an actuation of a safety sensor connected to a fieldbus before the corresponding safe state of its safety actuator(s) is achieved in the presence of errors or failures in the safety function channel. Response time of the combination of the drive and the FSO. See also term Response time of FSO on page 26.
Safety module	Part of a safety system, physical entity. Example: FSO safety functions module.

Term / Abbreviation	Description
Safety related control function (SRCF)	Control function implemented by a SRECS with a specified integrity level that is intended to maintain the safe condition of the machine or prevent an immediate increase of the risk(s)
Safety related electrical control system (SRECS)	Electrical control system of a machine whose failure can result in an immediate increase of the risk(s)
Safety system	Whole safety system including for example human interface, FSO safety functions module, drive, sensors and machine.
SAR	Safe acceleration range. In the FSO module, there are two sets of SAR parameters (SAR0 and SAR1) that are used to define and/or monitor the deceleration ramp in safety functions. SAR0 parameters are used in the SSE function. SAR1 parameters are used in SS1, SLS, varSLS and SDI functions.
SBC	Safe brake control
SC	Systematic capability (IEC 61508)
Scaling speed	A user-defined value that the FSO module uses as a speed reference point in ramp time calculations. See parameter 200.202 SAR speed scaling on page 406 .
SDI	Safe direction
SELV	Safety extra-low voltage
SFF	Safe failure fraction (%) (IEC 61508)
SFRT	Safety function response time (see page 26)
SIL	Safety integrity level (1...3) (IEC 61508, IEC 62061, IEC 61800-5-2)
SLS	Safely-limited speed
SMS	Safe maximum speed
SS1	Safe stop 1
SS1-r	Safe stop 1 ramp monitored
SS1-t	Safe stop 1 time controlled
SSE	Safe stop emergency For example, safety fieldbus failure, speed monitoring trip limit hit (SLS and SMS), and direction monitoring limit hit (SDI) will activate the SSE safety function.
SSM	Safe speed monitor
SRECS	Safety related electrical control system (see page 27).
Status word	16-bit word from device to controller with bit-coded status messages.

Term / Abbreviation	Description
STO	<p>Safe torque off (EN/IEC 61800-5-2). In this manual, this term is used in two different contexts:</p> <ul style="list-style-type: none"> • the STO circuit in the drive (the drive STO function) • the STO safety function in the FSO module. <p>Safety functions in the FSO module (eg, STO, SSE, SS1 and POUS) activate the drive STO function, that is, open the drive STO circuit. In addition, some safety functions can activate the STO safety function in the FSO module, which in turn opens the drive STO circuit. See section Dependencies between safety functions on page 194.</p>
Stop category	<p>There are three categories of stop functions:</p> <ul style="list-style-type: none"> • stop category 0: an uncontrolled stop where power to the machine actuators is removed immediately • stop category 1: a controlled stop where the machine actuators have power for stopping, after which the power is removed • stop category 2: a controlled stop where the machine actuators continue to have power. <p>Stop category 0 and 1 definitions also apply to Emergency stop categories.</p>
T1	<p>Proof test interval. Defines the probabilistic failure rate (PFH or PFD_{avg}) for the safety function or subsystem. Performing a proof test at a maximum interval of T1 is required to keep the SIL capability valid. The same interval must be followed to keep the PL capability (EN ISO 13849) valid. Note that any T1 values given cannot be regarded as a guarantee or warranty. See also section Proof tests on page 514.</p>
T_M	See Mission time.
TP	Test pulse. Term diagnostic pulse is used in this manual.
TWCDDT	Total worst-case delay time
Validation	Confirmation by, for example, analysis that the safety system meets the functional safety requirements of the specific application.
Verification	Confirmation by, for example, testing that the safety system meets the requirements set by the specification.
WCDT	Worst-case delay time
WD	Watchdog
ZCU	Type of control unit
Zero speed	<p>Speed limit where a ramp stop safety function is considered to be completed and drive STO is activated. The acknowledgement of the safety function becomes possible when this speed is reached.</p> <p>Zero speed limit is given with parameter FSOGEN.51 Zero speed without encoder on page 410 or, when an encoder is used, FSOGEN.52 Zero speed with encoder on page 410.</p>
λ_d	Dangerous failure rate

Term / Abbreviation	Description
λ_{du}	Dangerous failure rate, undetected failures
λ_s	Safe failure rate

Certificates

TÜV Nord certificate for the FSO-21 and ACS880/DCS880 drive series can be found in ABB Library. Check the validity of the certificate with a specific drive variant from the ABB Library.

The PROFIsafe certificate for the FSO-21 module is attached below.



Certificate

PROFIBUS Nutzerorganisation e.V. grants to

ABB Oy

Hiomotie 13, 00380 Helsinki, Finland

the Certificate No: **Z20147** for the PROFIsafe Module:

Model Name: FSO-21
Order-Number: 3AXD50000012090
Revision: SW: V4.3.0; HW: 1
Application CRC: Channel A: 0x63F41365
Channel B: 0xB630A569

This certificate confirms that the product has successfully passed the certification tests with the following PROFIsafe scope:

PROFIsafe_V2 functionality on PROFINET IO

Test Report Number: PS087-3
Authorized Test Laboratory: SIEMENS AG, Fürth, Germany

The tests were executed in accordance with the following documents:
"PROFIsafe - Test Specification for F-Slaves, F-Devices, and F-Hosts, Version 2.1, March 2007".

This certificate is granted according to the document:
"Framework for testing and certification of PROFIBUS and PROFINET products".

For all products that are placed in circulation by **June 22, 2023** the certificate is valid for life.

Karlsruhe, August 06, 2020

Board of PROFIBUS Nutzerorganisation e. V.

(Official in Charge)

(Karsten Schneider)



(Dr. Jörg Hähnliche)

3

Safety information and considerations

Contents of this chapter

This chapter contains general safety considerations and information to be taken into account when applying the FSO safety functions.



WARNING! The FSO safety functions module is delivered with the safety functions bypassed by jumper wires in connectors X:113 and X:114 to allow initial drive commissioning without the need to configure safety functions first. The safety system must always be properly commissioned and verified/validated before it can be considered safe.



WARNING! Make sure that the functional safety of the machine is maintained in situations where the safety option does not provide protection, for example, during commissioning, system maintenance, fault tracing, or decommissioning.

Use of safety functions

To make sure that the application, where FSO and its safety functions are used, is safe to use and fulfills all relevant safety requirements, it is necessary to take into account the requirements of the local (machinery) safety legislation (eg, Machinery Directive) and/or the applicable functional safety standards (eg, ISO 13849-1).

Implementing safety functions to make safe applications requires a systematic approach/process, where risk assessment is the basis of all safety requirements. These processes are described in global ISO and IEC machinery safety and

functional safety standards (eg, ISO 12100, 13849-1, IEC 62061). These are also introduced in *Functional safety; Technical guide No. 10* (3AUA0000048753 [English]).

Before you take into use any system where FSO and its safety functions are used, or if you later modify any application parameters or the configuration related to safety, you must ensure the safety of the entire system. This is done by verifying and validating the correct operation of the safety application according to the system safety verification plan. See chapter [Verification and validation](#).

Meeting the requirements of the Machinery Directive

If the machine, where FSO is part of the safety system, is going to be sold or taken into use in Europe, it is the responsibility of the machine builder / OEM / system integrator to make sure that the machine is safe to use and the essential health and safety requirements (EHSR) of the Machinery Directive are fulfilled. The requirements in the applicable standards must also be met and the FSO module must be used according to the instructions provided in this manual.

Responsibilities

As a component manufacturer, ABB is only responsible for the safety and conformity of their manufactured products, not of the systems where these products are used. If you detect any failure in safety functions, contact your local ABB representative.

Intentional misuse

Use the FSO and FSE modules according to the instructions given in the user's manuals. ABB is not responsible for any damage caused by the misuse of the modules.

The FSO and FSE modules are not designed to protect a machine against intentional misuse or sabotage.

Safety-related parts

The FSO module and the drive Safe torque off (STO) channel/function are safety relevant, and the rest of the drive is considered as not safety relevant. For example, the drive regular I/O cannot be used for requesting safety functions on the FSO.

Limitations of Safe torque off (STO) function

The Safe torque off function can be used for stopping the drive in the operational mode. If a running drive is stopped by using the STO function, the drive stops by coasting. STO function can also be used for prevention of unexpected start-up according to the limitations of IEC 60204-1, 5.4 and ISO 14118.

The Safe torque off function does not disconnect or isolate the voltage of the main and auxiliary circuits of the drive. Therefore maintenance work on any electrical parts

of the system (including drive and the motor) can only be carried out after a proper isolating procedure, which must be obeyed to make sure that the maintained part of the system is properly isolated.

■ Proof testing

Periodic proof testing of, for example, electromechanical parts of the safety system may be required in order to maintain the claimed SIL / PL level of the system. In this case proof testing must be taken into consideration in the safety calculations and it must be properly documented in the user documentation. Proof testing has to be verified in the acceptance testing during the commissioning phase.

The FSO module itself does not require periodic proof testing.

External contactors, relays and mechanical actuators must be sized correctly for safety use as the automatic diagnostics only monitors the electrical connections; the mechanical final elements like brakes are not diagnosed.

Failure of a mechanical actuator, for example a brake, could lead up to an undetected fault, and a possible loss of the load control.

■ Safety separation

The FSO module and the drive Safe torque off (STO) channel/function are safety relevant, and the rest of the drive is considered as not safety relevant, for example, the drive regular I/O cannot be used for requesting safety functions on the FSO.



WARNING! The Safe torque off function does not disconnect the voltage of the main and auxiliary circuits from the drive. Do not do maintenance work on the electrical parts of the drive or the motor before you isolate the drive system from the main supply, from rotating permanent magnet motors, from rotating motors equipped with sine filters and from all dangerous external voltages.

Note: The Safe torque off function can be used for stopping the drive in the operational mode. If a running drive is stopped by using the STO function, the drive stops by coasting.

■ ACS880 drives with separate inverter and supply units

In ACS880 drives with separate inverter, supply and brake units, the FSO module is connected to the inverter unit(s). It cannot be connected to supply or brake units.



Overview

Contents of this chapter

This chapter briefly describes the FSO module with safety system components as well as the FSO module layout, connections, type designation label and operational characteristics.

Intended use of the FSO module

FSO-21 is a safety option module for ABB ACS880/DCS880 drives, which adds safety functionality, including support for PROFIsafe communication with a safety PLC through an FB module. FSO-21 also supports the use of a safety encoder together with the FSE-31 module.

The intended use of the FSO module is to safely monitor and stop the drive (PDS(SR), VSD) if necessary, in case a dangerous or unexpected event occurs that requires a safe reaction of the safety related control system.

The main purpose of the FSO module is to make the systems/applications safe to use. It can be the main safety logic for the safety system, or it can be part of a larger safety related control system as a subsystem.

The FSO module can be used in applications where EN ISO 13850 is used. This standard gives the requirements for the emergency stop function of the machine (that can be implemented with FSO functions STO, SS1 and SSE). It is necessary to know the [Priorities between safety functions](#), see page 194.

The FSO module can be used with applications that comply with standard ISO 14118. This standard defines the requirements for the prevention of the unexpected start-up (POUS) of the machine (that can be implemented with FSO functions POUS, STO and SS1).

System description

The FSO module includes various safety functions that can be used for implementing safety functions in various applications, such as emergency stop, and safe speed limiting, etc. as presented in the figure. The FSO module is one part of the functional chain of the safety functions where external components together with FSO are connected to create complete safety systems. This user's manual gives overall information on how to implement safety functions with FSO module, regarding the SIL/PL requirements, functionality, and restrictions of use. The safety requirements for the application are defined in the system-specific risk assessment. The system integrator must obey those requirements when he/she implements safety functions with the FSO module.

■ FSO module and safety system components

Example figure of a safety system with the FSO-21 safety functions module, the ACS880-01 drive, a safety PLC, an FB module, an FSE module, switches and buttons.

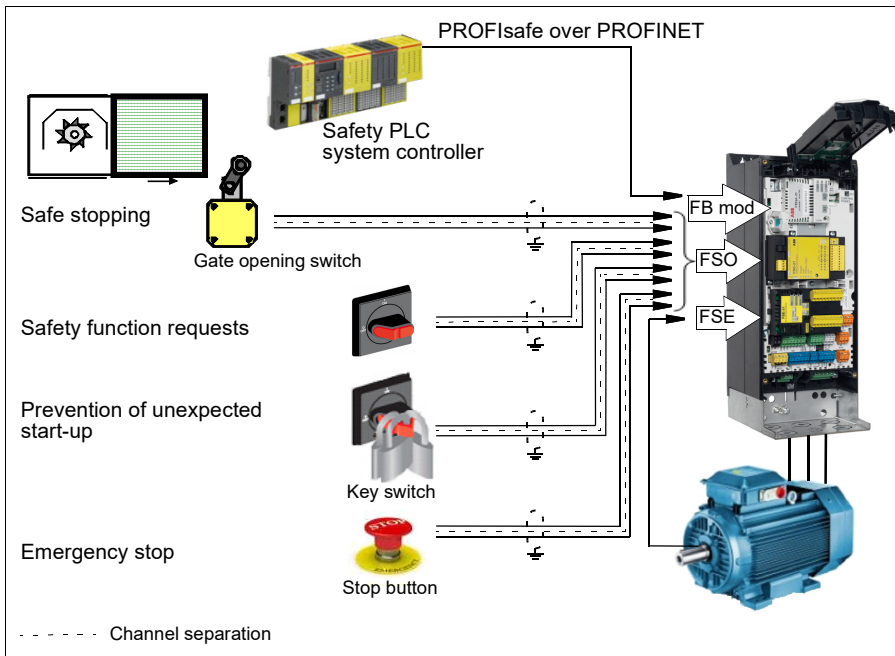

The FSO safety functions module is an option for the ACS880/DCS880 drives. The Safe torque off (STO) function is a standard feature on the ACS880/DCS880 drives.

The FSO module does not operate the drive; it only monitors the actions of the drive and commands safety functions to be executed. The request for safety functions can come from an external safety system, for example, a push button, a safety PLC, or

from an FSO internal fault. Some safety functions can be permanently active. If the drive does not fulfill the commands of the FSO, the FSO stops the drive modulation using the Safe torque off (STO) function.

If the drive is connected to a safety PLC, the safety of the fieldbus communication can be secured with the PROFIsafe over PROFINET technology. The safety PLC is connected to the FB module, which communicates with the FSO module. For more information, see chapter [PROFIsafe](#).

If a pulse encoder is used in the safety system, it is connected to the FSE-31 module, which communicates with the drive and the FSO-21 module.

Safety functions supported by the FSO module are presented in chapter [Safety functions](#).

■ FSO module version handling

To ensure backward and forward compatibility with the ACS880/DCS880 drives, the FSO-21 module has a version handling system. Both the FSO module and the ACS880/DCS880 drive firmware must support the used safety functions.

You can always replace the FSO-21 module with a newer revision and use the same configuration file with the new revision. If you replace an FSO-12 module with an FSO-21 module, you have to re-configure the FSO module and safety functions. Each time you make any changes in the safety system, you must do the acceptance test to each safety function using the checklists described in chapter [Verification and validation](#).

Note: Due to an update in functionality related to a situation where drive modulation is lost when SLS function is active, it is recommended to update all FSO modules to revision H (or later).

Each new revision of the FSO-21 module supports all or most functions of previous FSO-21 module revisions and it can be used together with previous ACS880/DCS880 drive firmware versions. In addition, previous FSO-21 module revisions can be used together with new ACS880/DCS880 drive firmware versions. In this case, the drive supports only the functions of the previous FSO-21 module revision. For more information on product compatibility, see section [Compatible products](#) on page 18.

In the Drive Composer pro PC tool, each safety function and parameter group has a version parameter. With these parameters, the user selects the desired versions. Only the versions that are supported by both the drive firmware and the FSO module are shown in Drive Composer pro.

Layout

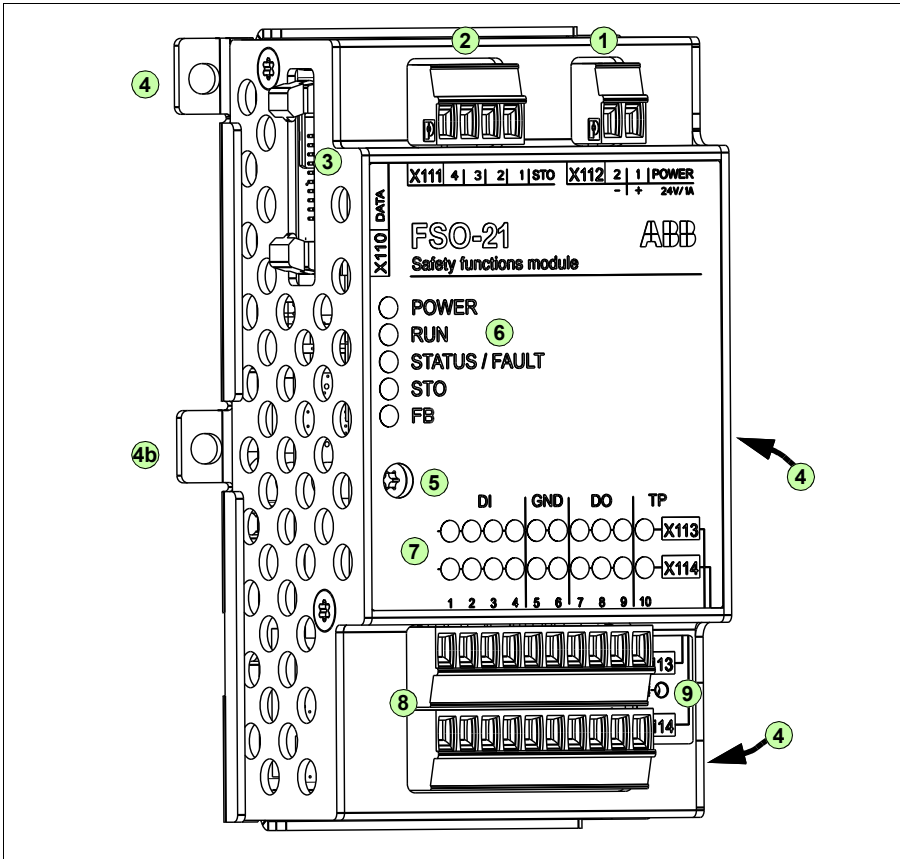

No	Description
1	24 V DC input connection
2	Safe torque off (STO) connection
3	Data connection
4, 4b	Mounting for drives with ZCU-12 control unit shown. Two mounting points on each side. The screw fixed at 4b also grounds the enclosure of the FSO. Mounting points for drives with other control units may vary.
5	FSO grounding screw, grounds the electronics
6	FSO status LEDs, see section Status LEDs on page 491.
7	Input / output status LEDs, one for each I/O connector. The LEDs are in two rows above the corresponding two rows of I/O connectors. The LED is lit if the state of the corresponding I/O is ON (24 V in the input or output). The data shown by LEDs is <u>only indicative and cannot be considered safe.</u>

No	Description
8	Input / output connections <ul style="list-style-type: none"> • 4 redundant or 8 single digital inputs, or combinations of redundant and single inputs. Possible redundant pairs: X113:1 & X114:1, X113:2 & X114:2, X113:3 & X114:3 and X113:4 & X114:4. • 3 redundant or 6 single digital outputs, or combinations of redundant and single outputs. Possible redundant pairs: X113:7 & X114:7, X113:8 & X114:8 and X113:9 & X114:9. • two 24 V DC reference outputs with configurable diagnostic pulses.
9	Factory reset button (under the label)

■ Connections

The FSO module has several safety I/Os for external safety devices, for example buttons, gates and indicators.

When you use the Safe brake control (SBC) function, the FSO module controls the mechanical brake. For more information on the SBC function, see chapter [Safety functions](#).

One FSO module is needed for each drive/inverter to be monitored.

Connection details are described in section [Terminals](#) on page [301](#).

■ Type designation label

The type designation label is attached on the top of the FSO module. An example label and description of the label contents are shown below.

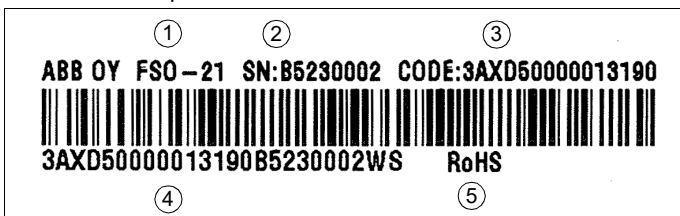

No	Description
1	Type
2	Serial number of format RYWWSSSS, where R: Component revision: A, B, C, ... Y: Last digit of the manufacturing year: 4, 5, ... for 2014, 2015, ... WW: Manufacturing week: 01, 02, ... for week 1, week 2, ... SSSS: Integer starting every week from 0001
3	ABB MRP code of the FSO module
4	Combined ABB MRP code, serial number and manufacturing location
5	RoHS mark

■ Operational characteristics

The FSO module monitors that the drive operates within the configured safety limits when safety functions are active, and if the limits are exceeded, activates a safe stopping in the drive within the response time. The safe stopping function activates the drive STO function either immediately or after an emergency ramp. Activation of the drive STO function removes the torque and, if configured, applies the brake.



WARNING! The Safe torque off function does not disconnect the voltage of the main and auxiliary circuits from the drive. See the warning on page [33](#).

The supported functions are preprogrammed in the FSO firmware; they cannot be programmed in any way.

Authorized personnel configure the FSO module with the Drive Composer pro PC tool. The FSO module checks the authorization with a password before it is possible to edit the FSO parameters. The user sends the parameters from the tool to the drive, after which the FSO module and the PC tool validate the configuration, and the tool asks the user to confirm the validation.

The FSO module goes into the Fail-safe mode if it detects an internal fault during its diagnostics tests (see section [FSO modes](#) on page [60](#)) and must be rebooted (for rebooting instructions, see section [FSO recovery](#) on page [506](#)).

The FSO module checks on every boot that the drive has the same configuration as the FSO module. If the configurations do not match, the FSO module keeps the STO active.

When the FSO module is configured with the Drive Composer pro, the tool will do a sanity check for the FSO configuration to make sure that it is plausible. Despite of this, the user must do the validation for the parametrization and for the functionality of the safety functions. The Drive Composer pro or FSO module cannot determine the validity of the configuration.

You must reboot the FSO module after the drive has recovered from a power failure, or after a control unit boot. FSO can be rebooted by switching the power off and on. It is also possible to reboot the FSO with drive parameter [96.09 FSO reboot \(ACS880\)](#) / [96.28 FSO reboot \(DCS880\)](#), or by pressing the **Boot FSO** button on the Safety view of the Drive Composer pro PC tool. The FSO module accepts this 'soft boot' when the FSO module is in fail-safe mode and the stopping function is completed.

■ Response times

Safety function response time and FSO response times are specified in section [Response times](#) on page [532](#).

The acceptable speed limits must be configured so that the speed cannot accelerate/decelerate from an acceptable speed to a dangerous speed faster than the response time of the FSO module.

■ FSO diagnostics

The FSO module performs extensive auto diagnostics tests during the runtime operation on FSO internal parts as well as the communication and STO connection between the FSO and the drive. The FSO goes into the Fail-safe mode if it detects a fault.

- The communication between the FSO and the drive is diagnosed continuously.
- The STO connection between the FSO and the drive STO connector is diagnosed during the power-up and periodically during the runtime.

If an FSO redundant I/O failure occurs, FSO module activates (or keeps active) the safety function that has been configured to the I/O. For all other I/O or safety fieldbus failures, the FSO module activates the SSE function. Also, the overtemperature fault of the FSO module activates the SSE function (for more information, see section [Configuring SSE](#) on page 353). In other internal failure situations, the FSO module activates the STO function.

■ I/O

The FSO module supports input and output redundancy.

The FSO module provides an option for applying diagnostic pulsing for its inputs and outputs. When applied, the pulsing enables the FSO diagnostics to detect cable failures as follows:

- **Inputs:** Open-circuiting and short-circuiting failures are detected with diagnostic pulsing. The failures that short-circuit the sensor are detected upon input activation when redundant connection is used.

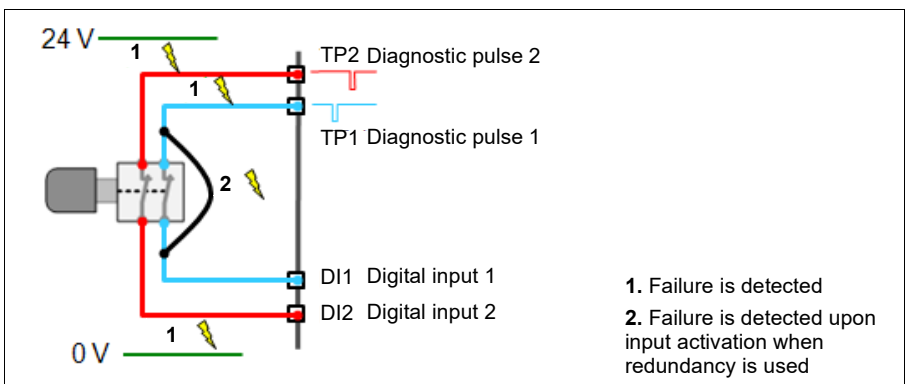

Note: If only one of the redundant inputs is activated upon a safety function request, the FSO module activates the safety function in which the input is configured but it cannot be acknowledged before the failure has been repaired. To acknowledge the safety function, you must set both input channels down and up at the same time or, switch the power off and on.

Note: ABB recommends to use external devices which are equipped with either a positive mechanical action or force guided contacts.

Note: With external test pulses, the length of the pulses shall be 0.5 ... 2 ms. Test pulses must be in totally different phasing, and must not overlap.

- **Outputs:** If diagnostic pulsing is used, failures that short-circuit the signal to the voltage supply or the ground potential are detected. Failures that open-circuit the actuator are not detected.

You can select the logical signal level for each digital output by a parameter. The selections are Active low (0 V) and Active high (24 V). Select the level depending on the application requirements. For example, Active high is suitable for the SLS indication and Active low for the SBC output. The FSO module operates according to the de-energize to 0 V principle, which means that in case of power loss or Fail-safe situation, the outputs will go to the low state (0 V).



WARNING! Only use the Active high selection of a digital output for indicating a status. Do not use the selection for the control of a safety device.

■ Acknowledgement

Safety functions have four acknowledgement methods for entering the Operational state (at power-up or after a safety function request is removed):

- **Manual** (recommended): The user must first acknowledge the FSO locally from the FSO I/O to allow the drive to restart.
- **Automatic:** The FSO grants the drive permission to restart after a safety function request is removed or the power-up process is completed. If the drive is in the automatic start mode, it starts automatically, which may cause danger.
- **From a safety PLC:** The FSO module expects an external acknowledgement signal from a safety PLC via the PROFIsafe communication bus.
- **Manual or from a safety PLC:** The FSO module expects an external acknowledgement signal either from the FSO I/O or from a safety PLC.

The acknowledgement method can be selected separately for the power-up, the STO (SSE and SS1 always end in drive STO), SLS, SDI and POUS safety functions.

For more information, see section [Acknowledgement methods](#) on page 55. For fault recovery, see chapter [FSO recovery](#) on page 506.



WARNING! If the FSO module has the automatic acknowledgement in use, make sure that it does not cause an unacceptable risk, for example, due to an automatic start of the drive.

■ Safety encoders

Safety pulse encoders are connected to the FSE-31 pulse encoder interface module. The safety pulse encoder delivers pulses to the FSE-31 module which delivers safe speed, direction and position information to the FSO-21 module. The safety encoders supported by the FSE module must fulfill these requirements:

- It must have differential outputs (two quadrature-signals and one rotation mark signal, each in its normal and complement format).
- It must have sufficient auto-diagnostics and mitigations against environmental variations for the intended PL and/or SIL.
- It must indicate its faults either by setting its outputs to the hi-Z state (“floating” the outputs) or by setting its complement outputs to identical states.

Note: It can be useful for the argumentation of the validity of the above that the encoder is approved for safety applications. When the FSE-31 module and a safety encoder are used in a safety function with a SIL/PL requirement, the safety encoder must be SIL/PL classified. The user must make sure that the SIL/PL capability of the safety encoder and the complete safety function meets the required SIL/PL.

With ACS880, two safety functions, SDI and STO with speed limit activated SBC, require a safety encoder. With DCS880, the safe speed estimate cannot be used, and it is recommended to always use an FSE-31 module with a safe encoder together with the FSO-21 module. The following table shows the requirements in detail.

Safety function	ACS880		DCS880	
	Can be used with safe speed estimate or with a safety encoder	Can only be used with a safety encoder	Can be used without encoder	Can only be used with a safety encoder
STO (with or without SBC)	x		x ²⁾	
SS1	x			x
SSE	x		x ³⁾	
SLS	x			x
varSLS	x			x
SMS	x			x
SSM	x			x
SDI		x		x
STO with speed limit activated SBC		x		x
POUS ¹⁾	-	-	-	-

1) POUS does not use motor speed data.

2) With or without time-controlled SBC.

3) Only immediate STO (with or without time-controlled SBC).

Note: The encoder used must be approved for safety applications.

■ Safe position

With the FSO-21 module, FSE-31 module, safety encoder and PROFINET adapter (FENA-21 or FPNO-21 module), it is possible to utilize safe position data via a safety PLC. To use the safe position data, a PROFI-safe connection and the PS2-profile are needed. See section [FSO PROFI-safe profiles](#) on page 203.

Note: With an HTL encoder, the position data can be lost with power loss, if there is a failure in any of the devices in the safety chain, or the bit `Speed_Pos_value_valid` of the PROFI-safe profile indicates invalidity. Rezeroing is needed to verify the position.

■ Motor speed feedback

FSO module needs motor speed feedback to perform safety functions. It can be either a measured speed from a safety encoder or a safe speed estimate. With FSO-12 module only safe speed estimate is available. FSO-21 module supports both safe speed estimate and measured speed from an HTL safety encoder via the FSE-31 encoder interface module. Depending of the motor speed feedback, safety functions operate slightly differently (for example, when the indications turn on and off) due to inaccuracy in safe speed estimate. The feedback type has also an effect on how the safety functions are configured. See chapter [Safety functions](#) for more information on the difference between the measured speed feedback (encoder) and safe speed estimate.

Note: With safe speed estimate, the FSO module and the drive motor control have an independent motor model of their own. The accuracy of these two speed estimates can differ from each other, especially in the low speed region.

Safe speed estimate

Note: Safe speed estimate cannot be used with a DCS880 drive.

With safe speed estimate, the FSO module uses the drive electrical output frequency measurement to estimate the motor speed. For safe speed estimate to operate correctly, parameter [FSOGEN.21](#) must be set to the motor synchronous speed, and [FSOGEN.22](#) must be set to the motor nominal frequency.

Using safe speed estimate with an induction (asynchronous) motor: The FSO module does not estimate or compensate for motor slip. If parameter [FSOGEN.21](#) is set to the motor nominal speed, this assumes that there is always a nominal slip/load at the motor. Depending on the application, a nominal slip/load is not always present. With [FSOGEN.21](#) set to the nominal speed, a lower than nominal slip/load can cause the motor speed to be higher than the safe speed estimate. Thus, it is recommended that you set parameter [FSOGEN.21](#) to the motor synchronous speed, not nominal speed. This will generate a safe speed estimate which is more accurate with lighter loads, but the accuracy decreases when more load/slip is present. The motor synchronous

speed depends on the frequency and number of poles (or pole pair number). Refer to the table that follows.

Nominal frequency	Number of poles in the motor						
	2	4	6	8	10	12	16
50 Hz	3000 rpm	1500 rpm	1000 rpm	750 rpm	600 rpm	500 rpm	375 rpm
60 Hz	3600 rpm	1800 rpm	1200 rpm	900 rpm	720 rpm	600 rpm	450 rpm

		ABB Sp. z o.o. ul. Placydowska 27 95-070 Aleksandrów Łódzki Poland					
				IEC60034-1			
3~ Motor		M2BAX 160MLA 4 IMB3/IM1001				2022	
No.							
V		Hz		kW		r/min	
A		cos ψ		Duty			
690	Y	50	11	1478	12.8	0.77	S1
400	D	50	11	1478	22	0.77	S1
660	Y	50	11	1475	13	0.80	S1
380	D	50	11	1475	22.5	0.80	S1
IE4-93.3%(100%)-93.6%(75%)-93%(50%)							
Product code		3GBA162410-ADN					
6309-2Z/C3 						6209-2Z/C3	
						181 kg	

With the example 4-pole induction motor shown above, it is recommended to use these values:

- [FSOGEN.21](#) = 1500 rpm
- [FSOGEN.22](#) = 50 Hz.

The FSO module has two safe speed estimation data channels. Speed in channel one is received from the drive ([200.01 FSO speed ch1](#)), and speed in channel two is calculated by FSO module ([200.02 FSO speed ch2](#)). FSO compares these two speed data sources. If the values differ too much, the FSO module detects it and goes into the Fail-safe mode.

The motor information must be set according to the motor type designation label for the FSO module. See section [How to configure general settings](#) on page [314](#).

It must be considered in the risk assessment of the application whether the safe speed estimate can be used.

Restrictions for the use of safe speed estimate

As the safe speed estimation is based on the drive electrical output frequency, there are characteristics which must be taken into account:

1. Safe speed estimate is available when the drive is modulating. If the motor shaft speed information must be safely available when the drive is not modulating, use a safety encoder together with the FSO-21 and FSE-31 modules for measuring the motor shaft speed.
2. Safe speed estimate can only be used in applications that do not have external active loads. Thus, it is not permitted to use safe speed estimate in applications that have, for example, hanging loads.
3. If the motor has slip (for example, an induction motor), the safe speed estimate differs from the drive actual motor shaft speed roughly the amount of the slip. See the graph below which illustrates the effect of the slip.
4. When the motor operates near zero speed (below 2 Hz / 3% of the nominal speed), there is ripple in the safe speed estimate signal. If the speed close to this region needs to be monitored by the FSO module using the safe speed estimate, the applicability of the estimate must be checked and considered case-by-case. For example, the motor type and number of pole pairs.
5. The drive and motor shall be dimensioned considering the application (for example, inertia, operating environment, etc). The dimensioning shall be such that all functions can be performed without exceeding the specified operating limits of the drive and motor.
6. The drive shall be dimensioned considering the motor and vice versa (for example, nominal current, nominal power, etc).
7. In the event of motor control loss, the motor shaft mechanical speed and the drive electrical output frequency can have a significant difference. The event can occur due to:
 - incorrect dimensioning of motor or AC-drive compared to the load (for example, inertia)
 - AC-drive motor control firmware failure
 - external active load
 - generator mode.

If deceleration is safety-related in the application, use a safety encoder together with the FSO-21 and FSE-31 modules for measuring the motor shaft speed, or use safety functions with ramp monitoring.

Note: When the motor shaft speed is below the monitored speed limit, then the motor shaft cannot accelerate over the speed limit, even in the event of motor shaft control loss.

The safe speed estimate calculated by the FSO module does not include slip compensation for induction motors. You must take this into account when you define monitoring limits for the safety functions. Otherwise it is possible that unnecessary monitoring limit hits occur. Using encoder for only control purposes decreases the ripple in the safe speed estimate signal. For example, defining a safe speed limit when using safe speed estimate with an induction motor:

SLS speed limit = Motor maximum permitted speed + expected motor slip + margin.

It is highly recommended to perform the best possible identification run that can be performed in the typical motor operating conditions (for example, shafts connected to motors, nominal temperature). This makes it possible to create the most accurate motor model for the speed estimation. If the Normal ID run is not possible, do the Reduced or Standstill identification run. For more information, see *ACS880 primary control program firmware manual* (3AUA0000085967 [English]).

The safe speed estimation can only be calculated when the drive is modulating. When the drive stops the modulation, the safe speed estimation shows 0 rpm. Because of this main principle, it is a must that the motor speed starts to slow down by coasting when the power is switched off. If the motor is not decelerating fast enough by coasting, the rotation must be stopped with external device, for example with a safe brake.

It is not allowed to use the safe speed estimation with an external active load that can accelerate the motor shaft. For example, in a hoist drive, the hanging load would potentially cause an accelerating motion because of the gravity, thus the safe speed estimate cannot be used for these types of applications.



WARNING! Applications with external active load must use a safety encoder and FSO-21 and FSE-31 modules.



WARNING! In an encoder fault situation, with an external active load, the FSO module is not permitted to switch the feedback from encoder to safe speed estimate (see parameter [S_ENCGEN.11](#)).

The diagram below shows an example of the SLS function, and the behavior of the safe speed estimation with an induction motor and its slip. It also illustrates the

possible effect (unnecessary limit hit) if you do not take the slip into account when defining the trip limits in the FSO module.

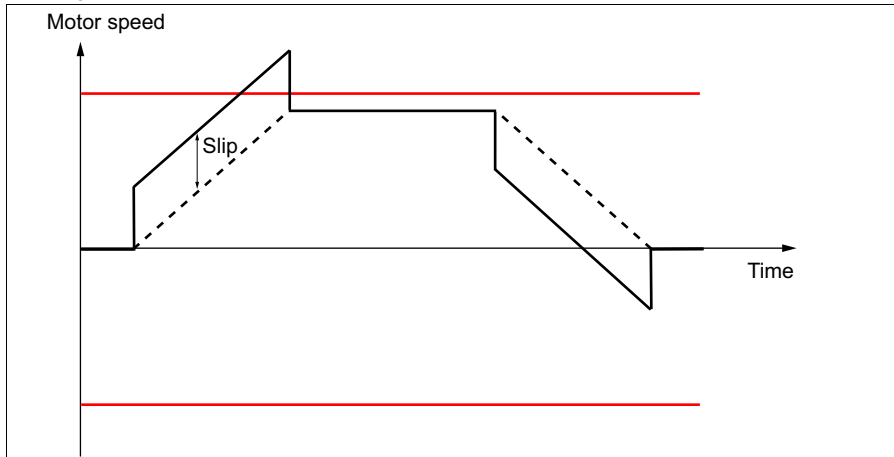

- - - Actual speed
- Safe speed estimate
- SLS trip limits

In the example, the motor torque is 100% during the acceleration and the motor slip is at its maximum value. The FSO module speed estimates (ch1 & ch2) reach the SLS trip limit even though the compensated value of the actual speed of the motor stays below the SLS trip limit.

When acceleration is completed, the motor torque decreases. The FSO module speed estimates show the actual motor speed and the slip is not any more visible in the signal, assuming that the load is minimal on constant speed. The more load there is, the more slip there will be, and thus inaccuracy increases also, but in the safe direction (motor speed is lower than safe speed estimate).

During the deceleration, when the motor torque is -100%, the motor slip is again in its maximum value. Because of the torque direction, FSO speed estimates are below the actual motor speed (amount of the slip). After the FSO safe speed estimates reach 0 rpm, they begin to show reverse (negative) motor speed due to the negative motor slip. The FSO module starts to compare the safe speed estimation to the negative SLS trip limit value. Because the trip limit is much lower than the estimated speed, there will be no fault trip.

Mute time feature



WARNING! The mute time increases the response time of the safety system. This must be considered in the design of the safety system.

The FSO module has a mute time feature that can be used to suspend the monitoring limits for a short period so that spurious trips can be eliminated. The feature is available for both safe speed estimate and safety encoder feedback. The mute time feature can be especially useful with the safe speed estimate because the estimate is more prone to spurious trips caused by for example rapid changes in motor torque. The mute time should be set as short as possible.

With safe speed estimate, there are two options to implement the mute time feature in the FSO. By default, general mute time parameter [FSOGEN.31](#) is used for all speed functions. Starting from FSO rev. J, it is also possible to enable function-specific mute times for limit hit situations with parameters [FSOGEN.38](#) and [FSOGEN.39](#). With safety encoder feedback, the general mute time parameter [FSOGEN.31](#) is always used. For more information, see section [Mute time feature](#) on page 65.

Overview of safety functions

This section gives a short overview of the safety functions and gives references to the detailed descriptions. For a description of the dependencies between the safety functions, see section [Dependencies between safety functions](#) on page 194.

■ Safe torque off (STO)

This safety function activates the STO function in the drive, this is, opens the STO circuit in the drive. The motor coasts to a stop (stop category 0). See section [STO function](#) on page 69.

The FSO module activates the STO function and the motor stops, if:

- the motor speed reaches the SAR0, SAR1, or time monitoring (ie, SS1-t) limits, or
- the FSO detects an internal failure, or
- an encoder fault with FSE-31 occurs.

■ Safe stop 1 (SS1)

This safety function stops the motor safely by ramping down the motor speed to zero speed (stop category 1). The FSO monitors the stop ramp either with the time or ramp monitoring method (SS1 function types SS1-t and SS1-r, respectively). See sections

- [SS1 with time monitoring \(SS1-t\)](#) on page 81 and
- [SS1 with ramp monitoring \(SS1-r\)](#) on page 85.

■ Safe stop emergency (SSE)

This safety function stops the motor safely by coasting (stop category 0) or ramping down (stop category 1) the motor speed to zero speed.

You can configure this safety function to be similar to the STO (SSE with immediate STO, stop category 0) or SS1 function (SSE with emergency ramp, stop category 1). See sections

- [SSE with immediate STO](#) on page 108,
- [SSE with time monitoring](#) on page 117 and
- [SSE with ramp monitoring](#) on page 121.

SSE is also activated in certain FSO fault reaction situations, see [Safe stop emergency \(SSE\)](#) on page 107.

■ Safe brake control (SBC)

This safety function provides a safe output for controlling external safety brakes. When you use the SBC function with other safety functions of the FSO module, it is always combined with the drive STO function. That is, the SBC function is activated before, at the same time with, or after the drive STO function, and also when an internal fault occurs as it activates STO.

Note: With an internal fault, the STO and SBC are activated simultaneously.

STO function and SSE with immediate STO

In these safety functions, you can configure the SBC function to be activated before, at the same time with, or after the drive STO function. See sections:

- [SBC after STO](#) on page 72,
- [SBC before STO](#) on page 75,
- [SSE with immediate STO, SBC after STO](#) on page 110 and
- [SSE with immediate STO, SBC before STO](#) on page 113.

When you use an encoder, you can also configure the SBC function to be activated at a user-defined speed limit with STO and SSE functions when drive is coasted with STO immediately. See sections

- [STO with speed limit activated SBC](#) on page 78 and
- [SSE with immediate STO, with speed limit activated SBC](#) on page 125.

Note: The SBC is activated also when the drive STO is activated at zero speed in the SSE and SS1 functions.

Note: The FSO module activates the SSE function after trip limit hits in the SLS and SMS functions. As a result, this activates the drive STO and SBC functions (for more information, see section [Safe stop emergency \(SSE\)](#) on page 107). Make sure that you dimension the brake correctly for these situations.

SS1 function and SSE with emergency ramp

In these safety functions, you can configure the SBC and STO combination to be activated at a user-defined speed limit while ramping down to zero speed. See sections

- [SS1 with speed limit activated SBC](#) on page 89 and
- [SSE with speed limit activated SBC](#) on page 125.

You can also define a delay so that the SBC is activated first at the user-defined speed limit and the drive STO after the delay. See sections

- [SS1 with speed limit activated SBC, SBC before STO](#) on page 89 and
- [SSE with speed limit activated SBC, SBC before STO](#) on page 133.

■ Safely-limited speed (SLS)

This safety function prevents the motor from exceeding user-defined speed limits. If the motor speed reaches the positive or negative SLS trip limit, the FSO module activates the SSE function and the motor stops. See section [Safely-limited speed \(SLS\)](#) on page 141.

■ Variable Safely-limited speed (SLS)

This safety function prevents the motor from exceeding user-defined speed limits. With the variable SLS function, it is possible to scale down the SLS limits with a safety PLC via PROFIsafe communication. See section [Variable Safely-limited speed \(SLS\)](#) on page 173 and chapter [PROFIsafe](#).

■ Safe maximum speed (SMS)

This safety function is used to protect the machine from too high speeds/frequencies. You can configure it to be permanently on or off. If the motor speed reaches the SMS trip limit, the FSO module activates the SSE function and the motor stops. There are two different versions of the SMS function. See sections

- [SMS function, version 1](#) on page 179 and
- [SMS function, version 2](#) on page 180.

■ Prevention of unexpected start-up (POUS)

This safety function prevents the machine from starting accidentally. The POUS function activates the drive STO function. See section [Prevention of unexpected start-up \(POUS\)](#) on page 181.

■ Safe speed monitoring (SSM)

This safety function provides a safe output signal to indicate whether the motor speed is between user-defined limits. See section [Safe speed monitor \(SSM\)](#) on page 183.

■ **Safe direction (SDI)**

This safety function monitors that the motor rotates into the correct direction. If the motor rotates into the forbidden direction more than the user-defined SDI tolerance limit allows, the FSO module activates the SSE function and the motor stops. This safety function requires that you use an encoder in the safety application. See section [Safe direction \(SDI\)](#) on page 187.

■ **Safe acceleration range (SAR)**

This safety function provides safe deceleration ramp monitoring for other safety functions. FSO module has two different SAR functions, SAR0 and SAR1.

SAR0 and SAR1 functions behave in the same way but they can be configured to work differently, based on the application needs. SAR0 parameters are used with the SSE function. SAR1 parameters are used with the SS1, SLS, varSLS, and SDI functions. For more information, see section [Configuring SAR](#) on page 363.



Safety functions

Contents of this chapter

This chapter describes how the safety functions of the FSO module operate.

The FSO-21 module supports these safety functions:

Safety function	Stop category	Information	Page
Safe torque off (STO)	Stop category 0	STO: standard drive feature	68
Safe stop 1 (SS1)	Stop category 1	With time (SS1-t) or ramp monitoring (SS1-r)	80
Safe stop emergency (SSE)	Stop category 0 or 1	With immediate STO or emergency ramp with time or ramp monitoring	107
Safe brake control (SBC)		With STO, SSE and SS1 functions	50
Safely-limited speed (SLS)		With time or ramp monitoring	141
Variable Safely-limited speed (SLS)		Only with PROFIsafe	173
Safe maximum speed (SMS)		Function permanently on/off Two different versions	178
		Version 1	179
		Version 2	180
Prevention of unexpected start-up (POUS)			181
Safe speed monitor (SSM)			183

Safety function	Stop category	Information	Page
Safe direction (SDI)		With time or ramp monitoring Only with an encoder	187

General

■ Safety function request

A safety function can be activated locally from FSO digital inputs, from a safety PLC, in FSO internal fault situations or by another safety function (see section [Dependencies between safety functions](#) on page [194](#)).

If you want to control a safety function with a push button, connect an activation button to an FSO digital input. 24 V in the input is the non-request for a safety function and 0 V is the request.

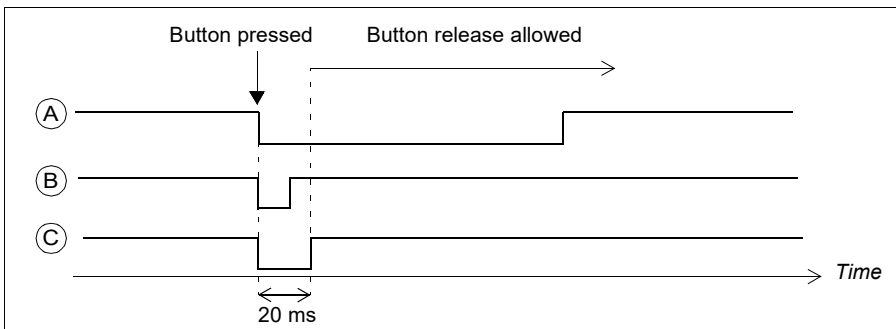

ID	Description
A	Normal request: The request is recognized when the button is pressed. The pressing time of the button must be at least 20 ms. Note: The safety function request must be removed before the acknowledgement is accepted.
B	Short low signals (less than 20 ms) are ignored.
C	Safety function is activated when the request signal last at least 20 ms.

Note: The FSO module executes the requested safety function even if the request is removed before the function has reached the acknowledgement criteria.

Note: With one input it is possible to activate up to two separate safety functions. A request activates both functions simultaneously. For the execution order, see section [Priorities between safety functions](#) (page [194](#)).

Note: The FSO module does not react to activation requests of the safety functions during the boot.

■ Acknowledgement methods

You can configure the acknowledgement method separately for the power-up, STO (SSE and SS1 always end in drive STO), SLS, SDI and POUS safety functions.

The acknowledgement method can be manual or automatic, from a safety PLC via the PROFIsafe communication bus, or either manual or from a safety PLC.

- **Automatic:** The FSO module acknowledges the power-up process and/or safety functions automatically when these have completed successfully and the safety function request has been removed.
- **From a safety PLC:** The FSO module expects an external acknowledgement signal from a safety PLC via the PROFIsafe communication bus. The PROFIsafe profiles include the acknowledgement bits (see section [FSO PROFIsafe profiles](#) on page 203).
- **Manual:** The FSO module requires a manual acknowledgement at the end of the power-up process and/or after successful completion of a safety function when the safety function request has been removed. The user must do this manually by pressing the acknowledgement button.

You can connect only one acknowledgement button to the FSO module. The acknowledgement button must be of type “normally closed” (NC). The acknowledgement button is connected like a normal safety input. 24 V in the input is the standby (negative) state and 0 V is the positive (acknowledge) state.

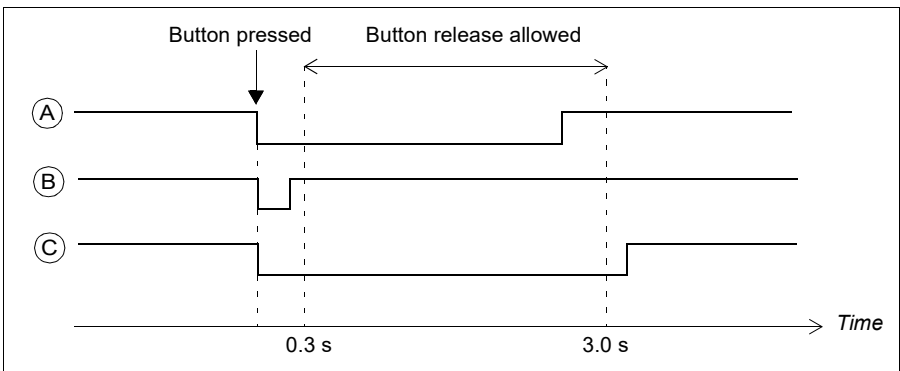

ID	Description
A	Normal acknowledgement: The acknowledgement is recognized when the button is released after pressing it; the system must detect both falling and rising edge changes for successful acknowledgement triggering. The pressing time of the button must be between 0.3 s...3.0 s.
B	Short low signals (less than 0.3 s) are ignored.
C	Too long interruptions (signal low longer than 3.0 s) on the signal are ignored and a warning message (A7D0) is generated to the drive. If there is something to acknowledge, it is ignored and the user must press the acknowledgement button again.

Acknowledgement can be performed if:

- A safety function request is not active.
- STO: Delay defined by parameter [STO.13 Restart delay after STO](#) or [STO.14 Time to zero speed with STO and modoff](#) has passed.

Note: If an SSE or SS1 request is received while the STO function is active, the STO function must be completed before the acknowledgement is allowed. For more information see section [Safe torque off \(STO\)](#) on page 68.

- SSE, SS1: Safety function is completed.
- SLS, Variable SLS, SDI: The monitoring has started.

When automatic acknowledgement is used, the FSO module acknowledges the safety function immediately after the safety function request has been removed and the above requirements are met.

When manual or acknowledgement from a safety PLC is used, the FSO module waits for an external acknowledgement signal (either from the FSO I/O or from a safety PLC) before it can acknowledge the safety function(s). After the FSO module has received the signal, it acknowledges all active safety functions that can be acknowledged with the same acknowledgement.

When several safety functions are active at the same time, the priorities described in section [Priorities between safety functions](#) (page 194) apply.

Note: If the FSO module is rebooted after a safety function request has been removed but before it has been acknowledged, the FSO reboot acknowledges the safety function.

■ DC magnetization and drive start modes

The correct operation of safety functions that limit or monitor motor speed (for example, SLS, SMS, SSM) requires that ID-run has been performed prior to operation.

Note: Motor speed estimation is disabled on drive side when certain start modes with magnetization or DC current control modes are active. SLS cannot provide reliable protection during motor start, when:

1. Motor start with magnetization is requested: parameter 21.01 'Start mode' = 'Fast' (0) OR 'Constant time' (1) OR 'Automatic' (2), OR
2. DC current control is enabled by parameter 21.08 'DC current control'. This parameter is associated with 'DC hold' and 'Post magnetization' features, OR
3. Motor pre-heating is enabled by parameter 21.14 'Pre-heating input source', OR
4. Continuous magnetization is enabled by parameter 21.12 'Continuous Magnetization command' = 'Magnetization active' (1), OR
5. Auto-phasing is enabled, OR
6. Fly-start is on.

This restriction is relevant only when FSO module is used with the safe speed estimate, not when it is used with the encoder.

For more information, see the firmware manual of your drive.

Ramp monitoring

The ramp monitoring is configured with five parameters as described below.

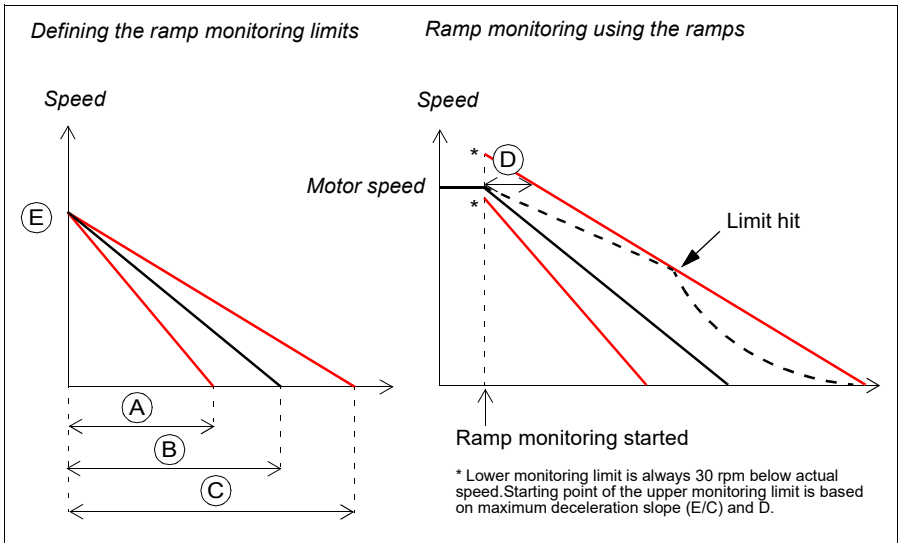

ID	Description
A	Minimum deceleration time from the Scaling speed to zero. Configured for each SARn ramp, n = 0...1 separately. For example for SAR0: parameter <i>SARx.11 SAR0 min ramp time to zero</i> .

B	Target time for deceleration from the Scaling speed to zero. Configured for each SARn ramp, n = 0...1 separately. For example for SAR0: parameter 200.102 SAR0 ramp time to zero .
C	Maximum deceleration time from the Scaling speed to zero. Configured for each SARn ramp, n = 0...1 separately. For example for SAR0: parameter SARx.12 SAR0 max ramp time to zero .
D	Initial allowed range for the SARn ramp: value of parameter SARx.02 SAR initial allowed range . This parameter moves the location of the maximum ramp forward on the time axis, when monitoring is started, that is, at time of D, the maximum limit is the value of the motor speed, that was in use when the monitoring started. Common for all ramps SARn, n = 0...1.
E	Scaling speed: value of parameter 200.202 SAR speed scaling . Speed value that the FSO module uses as a reference point in ramp time calculations. This value and the minimum (A), target (B) and maximum (C) ramp times define fixed slopes for the deceleration ramps that are used in ramp monitoring. Common for all ramps SARn, n = 0...1.

Limit hit: If the motor speed hits a ramp monitoring limit, the FSO module activates the STO function and generates an event. The user can select the event type (warning, fault or event) with parameter [FSOGEN.62 STO indication safety limit](#).

■ Safety function indications

Safety functions have the following indications:

- Request indication, which is shown in the control panel or in the event log (stopping functions (STO, SS1, SSE) and POUS)
- Digital output indication, see [Parameters](#) on page [403](#)
- Status bit indication, see [FSO PROFIsafe profiles](#) on page [203](#) and [Status and control words](#) on page [451](#).

Request indication

The safety function request indication for stopping functions (STO, SS1, SSE) and POUS is activated immediately when a safety function is requested. The type of the indication (event type) is selected with parameter [FSOGEN.61 STO indication ext request](#).

Note: For the POUS function, the request indication is always a warning if activated when the drive is not modulating, and the indication is a fault, when the drive is modulating, see [FSO premature POUS](#) on page [494](#).

FSO digital output indication

FSO digital outputs can be configured for indication or for controlling, eg, safety door locking/unlocking. Digital output indications for the safety functions are explained in connection with the safety function descriptions in chapter [Safety functions](#), in

[Configuring I/O](#) on page 321, and in [Parameters for FSO inputs and outputs](#) on page 443.

If configured to a function output parameter, the digital output is controlled to change state immediately when a safety function is requested. If configured to a function completed output parameter, the digital output is controlled to change state when a safety function is completed.

Note: A logic state of output indication signals can be configured to be active low or active high.

See also chapter PROFIsafe for [Remote I/O control](#) on page 201.

Status bit indication

PROFIsafe status bit indication of the safety function is relevant when the FSO module is part of a PROFIsafe control system. These are safety-related indications.

Note: Status and control words (see [Status and control words](#) on page 451) are not safety-related indications, and they can be used for monitoring purposes only. They are not allowed to be used as safe status and control indications in PROFIsafe/safety systems.

STO, SS1, SSE, POUS functions

States of the configured and connected functions are indicated with FSO digital outputs and fieldbus status signals when the function is started:

- Stopping functions (SSE and SS1) are always started and their active state indicated immediately (the monitoring method depends on the configuration) (parameters [SSE.21 SSE output](#) and [SS1.21 SS1 output](#)).
- The drive STO state is indicated when the drive STO circuit is open (parameter [STO.21 STO output](#) and octet 0 bit 7 STO_active).

Note: When the SBC is activated before the drive STO, the drive STO active state is indicated after a delay (parameter [SBC.12 STO SBC delay](#)).

Note: SBC active state is indicated only with status bit (octet 0 bit 6 SBC_active).

- POUS active state is indicated immediately when requested from an input ([POUS.21 POUS output](#)).
- Ramp monitoring (SAR0 and SAR1, see section [Configuring SAR](#) on page 363) is not indicated.

The FSO module switches off the digital output indications (SSE, SS1 and POUS functions) when the function is acknowledged.

Stop completed indications are activated when the stopping function has completed, but is not yet acknowledged. There are separate indications for each stopping function STO, SSE and SS1 (parameters [STO.22 STO completed output](#), [SSE.22 SSE completed output](#), [SS1.22 SS1 completed output](#)) and one common for all of

them (parameter [FSOGEN.11 Stop completed output](#)). The FSO module switches off the indications when the function is acknowledged.

The completed indication of the POUS function (parameter [POUS.22 POUS completed output](#)) is activated after the time defined by parameter [POUS.13 POUS delay for completion](#) has passed. The FSO module switches off the completed indication when the POUS request is removed.

SLS, Variable SLS

- SLS active state is indicated when the motor speed is in the user-defined range. The FSO module switches off the indication when the function is acknowledged or the monitored speed exceeds the user-defined limit (this also causes the SLS to trip, that is, the FSO module activates the SSE function).

SSM

- SSM indication goes on when the motor speed is in the user-defined range. The FSO module switches off the indication when the monitored speed exceeds the configured limit.

SDI

- SDI active state is indicated when the motor rotates in the correct direction. The FSO module switches off the indication when the function is acknowledged or the rotation direction changes to the forbidden direction (this also causes the SDI to trip, that is, the FSO module activates the SSE function).

For further information on indication and output parameters, see chapter [Parameters](#) on page [403](#), and [FSO PROFIsafe profiles](#) on page [203](#).

FSO modes

The FSO can be in one of the following modes:

- **Power down:** The power to the FSO is off. The drive STO circuit is open. The POWER LED is off.
 - **Start-up:** The FSO is starting up after power-up. Indicated with a blinking green RUN LED.
 - **Running:** The FSO is up and running. It can be in different states (see section [FSO states](#) on page [61](#)) depending on the status of safety functions and the safety fieldbus communication. Indicated with a green RUN LED.
 - **Fail-safe:** There is a failure in the FSO. The drive STO is active. Indicated with a red STATUS/FAULT LED. You have to reboot the FSO to exit the Fail-safe mode. See section [Transitions between FSO modes and states](#) on page [62](#).
 - **Configuration:** Parameters are uploaded from the FSO module. The drive STO is active. Indicated with blinking RUN and STATUS/FAULT LEDs. You can exit the Configuration mode by downloading the new configuration to the FSO or by rebooting the FSO.
-

For more information on the FSO LEDs, see section [Status LEDs](#) on page 491.

■ FSO states

When the FSO is up and running, it can be in one of the following states depending on the drive STO status:

- **Safe:** STO active, that is, the drive STO circuit is open and the motor is stopped. The SBC is active (if used).
- **Operational:** STO inactive.

In the Operational and Safe states, the FSO can execute the safety functions.

Note: When the POUS function is active, the FSO module is in the Operational state and the drive STO is active.

■ Transitions between FSO modes and states

The following diagram shows the possible transitions during normal operation of the FSO module.

- Power down: STO active, power off (below 19 V)
- Start-up: STO active, power on (above 19 V), start-up checks performed
- Configuration: STO active, setting of parameters
- Operational: STO inactive, FSO running
- Operational: STO active, POUS active, FSO running
- Safe: STO active, FSO running
- Fail-safe: STO active, I/O, FSO or communication fault detected. FSE module or encoder failure situation can also cause the Fail-safe transition. See parameter [S_ENCGEN.11](#).

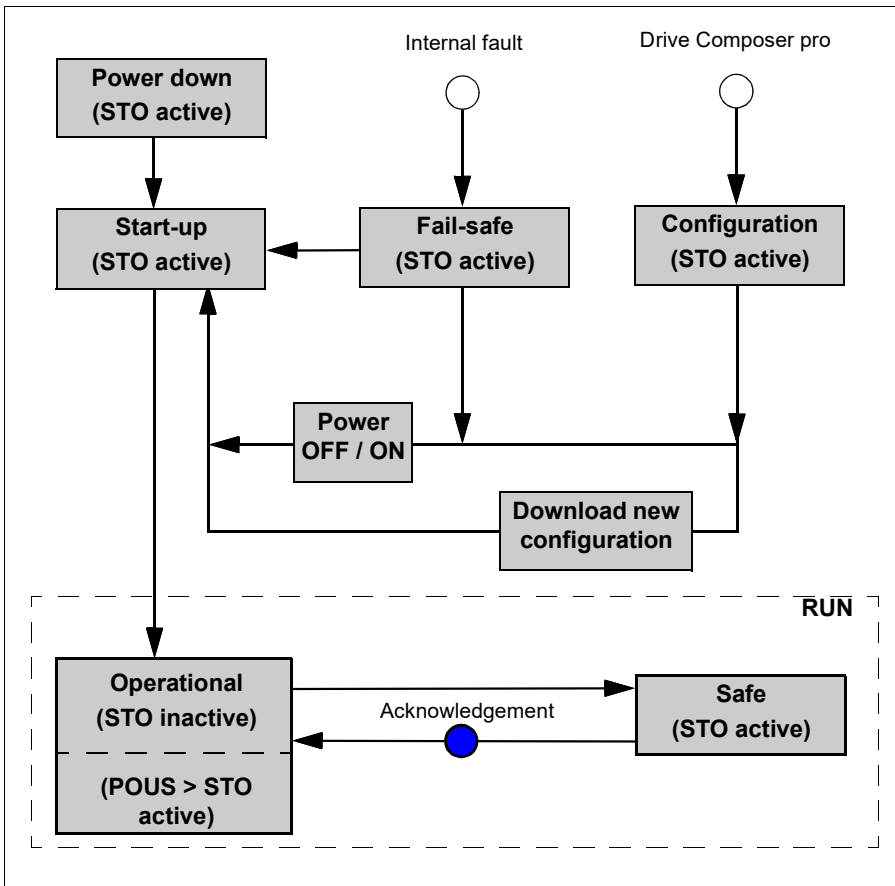

At power-up, the FSO goes into the Start-up mode. During the power-up process, FSO is in Safe state (STO active). It performs start-up checks and, according to the configuration, enters the Operational state either automatically or after an acknowledgement request from the FSO I/O or from a safety PLC.

The Drive Composer pro PC tool can request the Configuration mode, when the FSO is in the Start-up, Operational, Safe or Fail-safe mode and the drive is in the Torque off mode (not modulating). The FSO exits the Configuration mode into the Start-up mode when the user either:

- downloads the new configuration to the FSO, or
- reboots the module (for rebooting instructions, see chapter [FSO recovery](#) on page [506](#)).

If there is an internal fault, the FSO enters the Fail-safe mode. To identify and recover from the cause of the fault, see section [FSO recovery](#) on page [506](#).

The FSO exits the Fail-safe mode into the Start-up mode when the user reboots the module (for rebooting instructions, see chapter [FSO recovery](#) on page [506](#)).

When the FSO is in the Power down, Start-up, Configuration, Safe or Fail-safe mode, the drive STO function is always active. When the FSO is in the Operational state, the drive STO function is inactive (except when the POU S function is active, the drive STO function is also active).

Note: When the drive is connected to a safety PLC via the PROFIsafe over PROFINET communication bus, see the states diagrams in section [FSO module modes and states](#) on page [214](#) in chapter [PROFIsafe](#).

■ Cascade

It is possible to cascade up to six FSO modules into a daisy-chain type network (resembles somewhat an I/O master/follower system): If an FSO triggers a cascaded safety function, it passes the triggering information to the next FSO, which triggers the next one, and so on, until the last FSO again triggers the first one.

Without a PROFIsafe communication bus, you can cascade only safety functions which have a primary and a secondary digital input: STO, SS1, SSE, SLS1, SDI positive and SDI negative.

If you want to a cascade safety function which has only one digital input (SLS2, SLS3, SLS4, SSM1, SSM2, SSM3, SSM4), you must have a PROFIsafe communication bus and configure the safety function request from a safety PLC.

For detailed configuration instructions, see section [How to configure a cascaded system](#) on page [324](#).

This figure shows an example cascade configuration. Two different safety functions are cascaded in the same cascaded system. Safety function 1 is cascaded in one cascade loop (Cascade A) and safety function 2 in another (Cascade B).

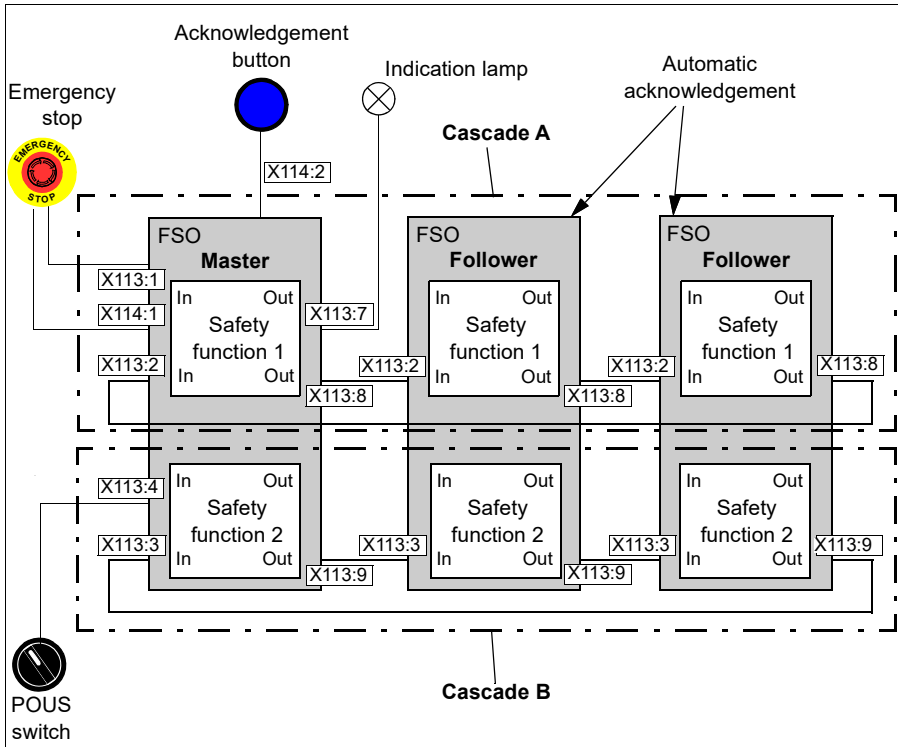

The inputs and outputs of the FSO module are defined as pairs. In this example, single input X113:2 is cascaded with single output X113:8 in Cascade A. When Emergency stop (Safety function 1 = SSE) is activated in the master FSO module (from a redundant digital input X113:1 & X114:1), it is also activated in the follower FSO modules via digital master FSO outputs. Safety function 2 is cascaded with single input X113:3 and single output X113:9 (Cascade B). When POUS (Safety function 2 = POUS) is activated in the master FSO module (from a single digital input X113:4), it is also activated in the follower FSO modules. Feedback from the last FSO in cascaded chain is wired back to master FSO.

You must configure one of the cascaded FSO modules as the master and the others as followers.

You can configure a separate safety function indication both in the master and the follower FSO modules. Use the completed output of the cascaded safety function for the indication - in this example, output X113:7 is used to indicate SSE completed.

You must configure all follower FSO modules to use the automatic acknowledgement method. The master FSO module can use any acknowledgement method. The acknowledgement always starts from the master FSO module.

You can configure one or two safety functions in the same cascaded system (Cascade A and Cascade B). If the whole cascaded system must trip after reaching a trip limit of any safety function, or with a safety fieldbus failure, you must cascade the SSE function.

If an FSO module activates the STO function (after a limit hit, an STO request from the I/O or the safety fieldbus, or after an internal fault), also the cascaded SSE output is triggered.

Note: When several drives are linked together in a master/follower system and the follower drive is in the torque control mode, stopping functions with a deceleration ramp (SSE with emergency ramp and SS1) will turn the follower drive to the speed control mode. For more information on the master/follower functionality in the drive, see the firmware manual.

■ Mute time feature



WARNING! The mute time increases the response time of the safety system. This must be considered in the design of the safety system.

Mute time feature with the safe speed estimation

When there are spurious transients in safe speed estimate, you can suspend speed monitoring with mute time to prevent unnecessary trips in the safety system. The transient mute time can be set to cover the transient situation with the parameter [FSOGEN.31 Transient mute time](#). This transient mute time covers limit hits, monitoring start, and zero speed limits.

It is also possible to use function-specific mute times for limit hit situations in SLSx, SMS, and variable SLS functions with the safe speed estimate (starting from FSO rev. J). Mute times for each of these functions can be set independently. In addition, they can be set longer than the transient mute time [FSOGEN.31](#).

By default, these function-specific mute times are disabled, and the value set to parameter [FSOGEN.31 Transient mute time](#) is used in limit hit situations instead. Function-specific mute times for limit hit situations of the SLSx and variable SLS functions can be enabled with the parameter [FSOGEN.38 Enable SLSx mute times](#).

After the SLSx specific mute times have been enabled, the following mute time parameters are used in limit hit situations.

- [SLSx.17 Mute time for SLS1](#)
 - [SLSx.27 Mute time for SLS2](#)
 - [SLSx.37 Mute time for SLS3](#)
 - [SLSx.47 Mute time for SLS4](#)
 - [SLSx.57 Mute time for variable SLS](#)
-

The function-specific mute time for SMS is activated with a separate parameter [FSOGEN.39 Enable SMS mute time](#). After the parameter [FSOGEN.39](#) has been activated, the mute time parameter [SMS.17 Mute time for SMS](#) is used in limit hit situations for the SMS function.

In monitoring start and zero speed limit situations, [FSOGEN.31 Transient mute time](#) parameter is always used even if the SLSx and SMS specific mute times are enabled.

Mute time feature with the safety encoder

When there are spurious transients in encoder speed data, you can use the transient mute time in the safety functions. The transient mute time can be set to cover the transient situation with the parameters:

- [FSOGEN.31](#) Transient mute time for safety function limit hits
- [FSOGEN.32](#) Zero speed delay time for zero speed
- [FSOGEN.33](#) Monitoring start delay for monitoring start.

When the safety encoder is used, function-specific mute times have no effect even if they are enabled.

If the switching from encoder to safe speed estimate is allowed by parameter [S_ENCGEN.11 FSE diagnostic failure reaction](#), you must also configure the mute times related to safe speed estimate. See section [Configuring the FSO for FSE or encoder failure situations](#).

Mute times in monitoring start, limit hit and zero speed situations

The parameters used for monitoring start, limit hit and zero speed situations are described in the time diagram and table below.

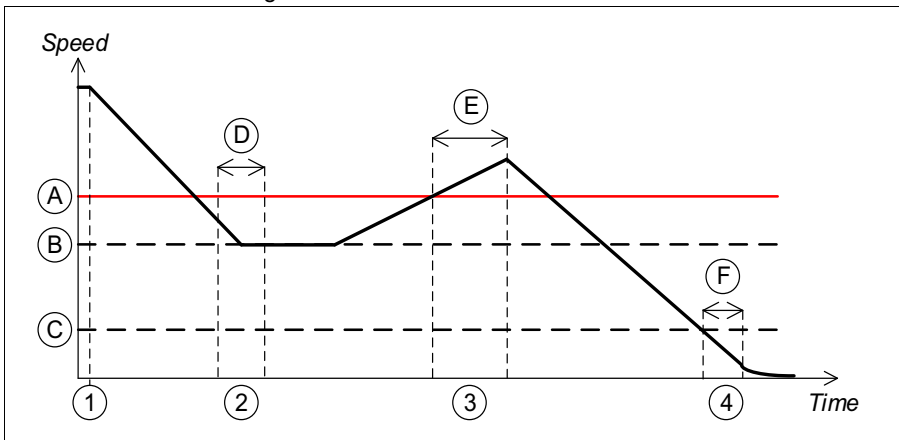

A SLS trip limit

B SLS limit

C [FSOGEN.51 Zero speed without encoder](#) or [FSOGEN.52 Zero speed with encoder](#)

- 1 SLS function is requested from higher speed than the SLS limit.
- 2 Monitoring start situation
- 3 Limit hit situation
- 4 Zero speed situation

	Monitoring start delay (D)	Limit hit (E)	Zero speed delay time (F)
Without encoder Function-specific mute times disabled	<i>FSOGEN.31</i>	<i>FSOGEN.31</i>	<i>FSOGEN.31</i>
Without encoder Function-specific mute times enabled	<i>FSOGEN.31</i>	Function-specific mute times	<i>FSOGEN.31</i>
With encoder	<i>FSOGEN.33</i>	<i>FSOGEN.31</i>	<i>FSOGEN.32</i>

Note: SS1 and SSE functions always use *FSOGEN.31* for limit hit situations.

Safe torque off (STO)

The STO function brings the machine safely into a no-torque state and/or prevents it from starting accidentally. The STO function in the FSO module activates the drive STO function, that is, opens the STO circuit in the drive. This prevents the drive from generating the torque required to rotate the motor. If the motor is running when the STO function is activated, it coasts to a stop.

You can configure the SBC function to be activated before, at the same time with, or after the drive STO function. When you use an encoder, you can also configure the SBC function to be activated at a user-defined speed limit.

This section describes the different versions of the STO function separately without and with an encoder.

For more information on the STO function in the ACS880/DCS880 drives, see the corresponding drive hardware manual.



WARNING! For the encoderless mode, you have to set parameters [STO.14](#) and [SBC.13](#) so that the motor has enough time to stop from full speed when modulation is stopped.

Note: If the SSE is cascaded, STO activation also activates the SSE cascade indication signal (output). See sections [Safe stop emergency \(SSE\)](#) on page [107](#) and [Cascade](#) on page [63](#).

Note: Always set the parameters related to the STO function to have the correct monitoring limit hit and fault reaction behavior. An internal monitoring of the FSO module can trigger the STO function even if you have not defined an external request signal. These internal monitorings trigger STO:

- SAR0, SAR1 or SSE/SS1 limit hit
 - FSO module fail safe state.
-

■ STO function

The operation of the STO function when the SBC is not used is described in the time diagrams and tables below. For configuration, see section [How to configure STO](#) on page 333.

Without an encoder

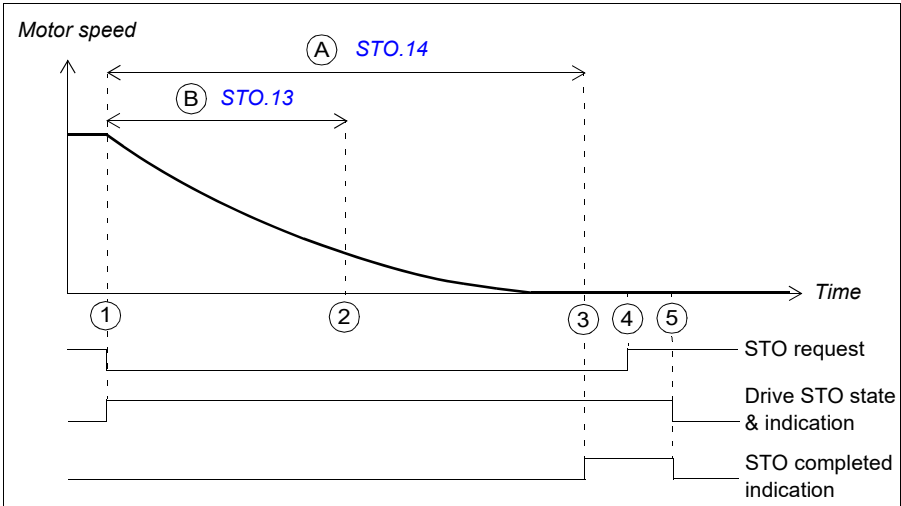

- A Time to zero speed (parameter [STO.14](#)): Time from the STO activation to the moment when the safety function is completed and the STO completed indication (parameter [STO.22](#)) goes on. You must set this to the estimated time in which the motor coasts to a stop from the maximum speed.
- B Restart delay after STO (parameter [STO.13](#)): Time from the STO activation to the moment when the acknowledgment becomes allowed. With this parameter, you can allow a restart of the drive before the motor has stopped (fly-start). You can use this feature only in certain applications. This parameter is relevant only when an external request activates the STO function.

Step	Description
1	The STO request is received (for example, from the I/O). The FSO activates the drive STO function and starts counters for times A and B. STO active indication parameter STO output (STO.21) goes on.
2	After time B has elapsed, the acknowledgement becomes allowed as soon as the STO request has been removed (step 4). Note: If an SSE or SS1 request is received while the STO function is active, the STO function must be completed before the acknowledgement is allowed.
3	After time A has elapsed, the FSO module defines the motor as stopped and the STO completed indication goes on.
4	The STO request is removed.

Step	Description
5	After the acknowledgement, the STO function is deactivated. The indications STO output (<i>STO.21</i>) and STO completed output (<i>STO.22</i>) go off.

With an encoder

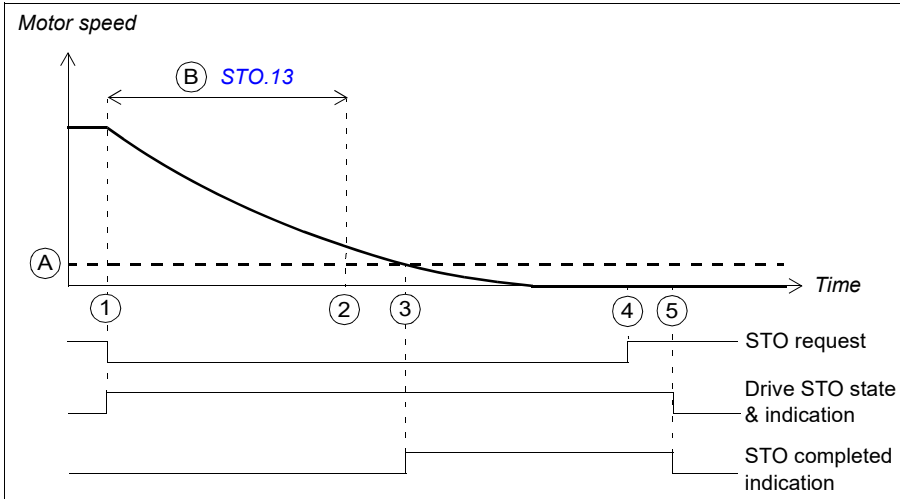

- A Zero speed with encoder (parameter *FSOGEN.52*): Speed limit at which the motor has stopped, the safety function is completed and the STO completed indication (parameter *STO.22*) goes on.
- B Restart delay after STO (parameter *STO.13*): Time from the STO activation to the moment when the acknowledgment becomes allowed. With this parameter, you can allow a restart of the drive before the motor has stopped (fly-start). You can use this feature only in certain applications. This parameter is relevant only when an external request activates the STO function.

Step	Description
1	The STO request is received (for example, from the I/O). The FSO activates the drive STO function and starts a counter for time B. STO active indication parameter STO output (<i>STO.21</i>) goes on.
2	After time B has elapsed, the acknowledgement becomes allowed as soon as the STO request has been removed (step 4). Note: The acknowledgement becomes allowed already at the zero speed limit (A) if it is reached before time B has elapsed. Note: If an SSE or SS1 request is received while the STO function is active, the STO function must be completed before the acknowledgement is allowed.
3	The motor speed reaches the zero speed limit (A), the FSO module defines the motor as stopped and the STO completed indication goes on.
4	The STO request is removed.

Step	Description
5	After the acknowledgement, the STO is deactivated. The indications STO output (STO.21) and STO completed output (STO.22) go off.

■ SBC after STO

The operation of the SBC after the STO function (positive SBC delay) is described in the time diagrams and tables below. For configuration, see section [How to configure SBC after STO](#) on page 335.

Without an encoder

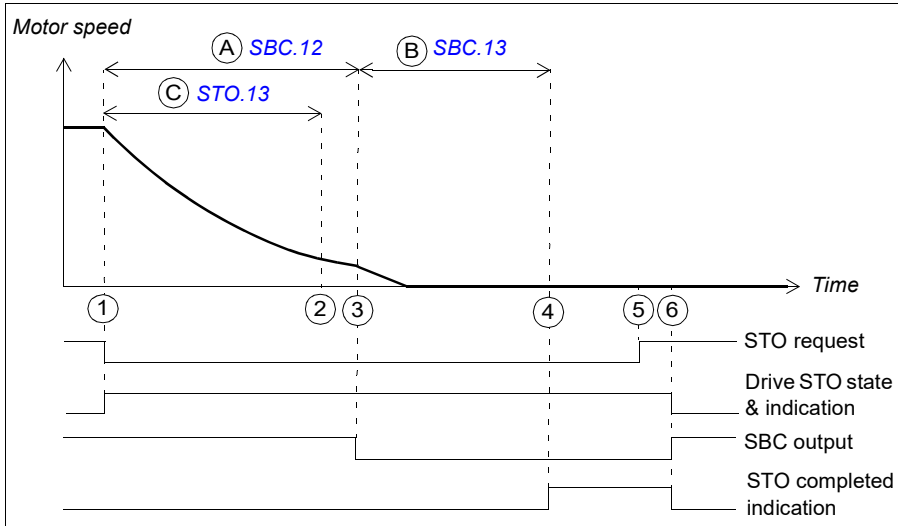

- A SBC delay (parameter [SBC.12](#)): Time from the activation of the drive STO function to the moment when the FSO activates the SBC function (brake). In this case the value is positive and the FSO activates the SBC after the drive STO. If the value is zero, the FSO activates the SBC and drive STO functions at the same time. **Note:** It is possible to set the SBC delay so that the SBC is activated while the motor is still rotating.
- B SBC time to zero speed (parameter [SBC.13](#)): Time from the SBC activation to the moment when the safety function is completed and the STO completed indication (parameter [STO.22](#)) goes on. You must set this to the estimated time in which the motor brakes to a stop from the maximum speed.
- C Restart delay after STO (parameter [STO.13](#)): Time from the STO activation to the moment when the acknowledgment becomes allowed. With this parameter, you can allow a restart of the drive before the motor has stopped (fly-start). You can use this feature only in certain applications. This parameter is relevant only when an external request activates the STO function.

Step	Description
1	The STO request is received (for example, from the I/O). The FSO activates the drive STO and starts counters for times A and C. STO active indication parameter STO output (STO.21) goes on.
2	After time C has elapsed, the acknowledgement becomes allowed as soon as the STO request has been removed (step 5).
3	After time A has elapsed, the FSO activates the SBC (brake) and starts a counter for time B.
4	After time B has elapsed, the FSO module defines the motor as stopped and the STO completed indication goes on.
5	The STO request is removed.
6	After the acknowledgement, the STO and SBC functions are deactivated, and the control is given back to the drive, which controls the brake from now on. The indications STO output (STO.21) and STO completed output (STO.22) go off.

With an encoder

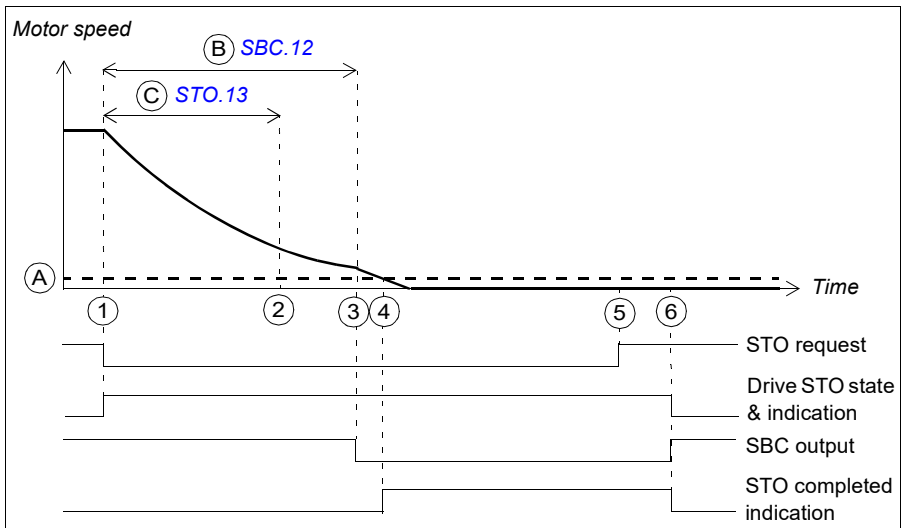

- A Zero speed with encoder (parameter [FSOGEN.52](#)): Speed limit at which the motor has stopped, the safety function is completed and STO completed indication (parameter [STO.22](#)) goes on.
- B SBC delay (parameter [SBC.12](#)): Time from the activation of the drive STO function to the moment when the FSO activates the SBC function (brake). In this case, the value is positive and the FSO activates the SBC after the drive STO. If the value is zero, the FSO activates the SBC and drive STO functions at the same time. **Note:** It is possible to set the SBC delay so that the SBC is activated while the motor is still rotating.

74 Safety functions

- C Restart delay after STO (parameter [STO.13](#)): Time from the STO activation to the moment when the acknowledgment becomes allowed. With this parameter, you can allow a restart of the drive before the motor has stopped (fly-start). You can use this feature only in certain applications. This parameter is relevant only when an external request activates the STO function.

Step	Description
1	The STO request is received (for example, from the I/O). The FSO activates the drive STO function and starts counters for times B and C. STO active indication parameter STO output (STO.21) goes on.
2	After time C has elapsed, the acknowledgement becomes allowed as soon as the STO request has been removed (step 5).
3	After time B has elapsed, the FSO activates the SBC function (brake). Note: If zero speed limit A is reached before time B has elapsed, the FSO activates the SBC function immediately when the motor has stopped.
4	The motor speed reaches the zero speed limit (A), the FSO module defines the motor as stopped and the STO completed indication goes on.
5	The STO request is removed.
6	After the acknowledgement, the STO and SBC are deactivated, and the control is given back to the drive, which controls the brake from now on. The indications STO output (STO.21) and STO completed output (STO.22) go off.

■ SBC before STO

The operation of the SBC before the STO function (negative SBC delay) is described in the time diagrams and tables below. For configuration, see section [How to configure SBC before STO](#) on page 337.

The reason to use a negative SBC delay is to have the mechanical brake closed just before the drive STO circuit is opened.

Without an encoder

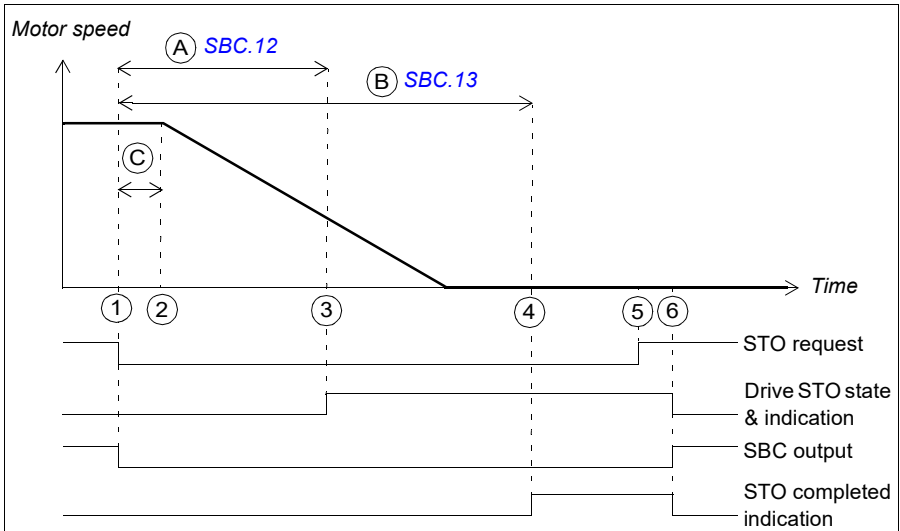

- A SBC delay (parameter [SBC.12](#)): Time from the activation of the drive STO to the moment when the FSO activates the SBC function (brake). In this case the value is negative and the FSO activates the SBC before the drive STO. If the value is zero, the FSO activates the SBC and drive STO functions at the same time.
- B SBC time to zero speed (parameter [SBC.13](#)): Time from the SBC activation to the moment when the safety function is completed and the STO completed indication (parameter [STO.22](#)) goes on. The acknowledgment becomes allowed. You must set this to the estimated time in which the motor brakes to a stop from the maximum speed.
- C Response time (depends on system configuration, see page [532](#))

Step	Description
1	The STO request is received (for example, from the I/O). The FSO activates the SBC function (brake) and starts counters for times A and B. STO active indication parameter STO output (STO.21) goes on.
2	After time C has elapsed, the SBC starts to brake the motor.
3	After time A has elapsed, the FSO activates the drive STO.
4	After time B has elapsed, the FSO module defines the motor as stopped and the STO completed indication goes on. The acknowledgement becomes allowed as soon as the STO request has been removed (step 5).
5	The STO request is removed.
6	After the acknowledgement, the STO and SBC functions are deactivated, and the control is given back to the drive, which controls the brake from now on. The indications STO output (STO.21) and STO completed output (STO.22) go off.

With an encoder

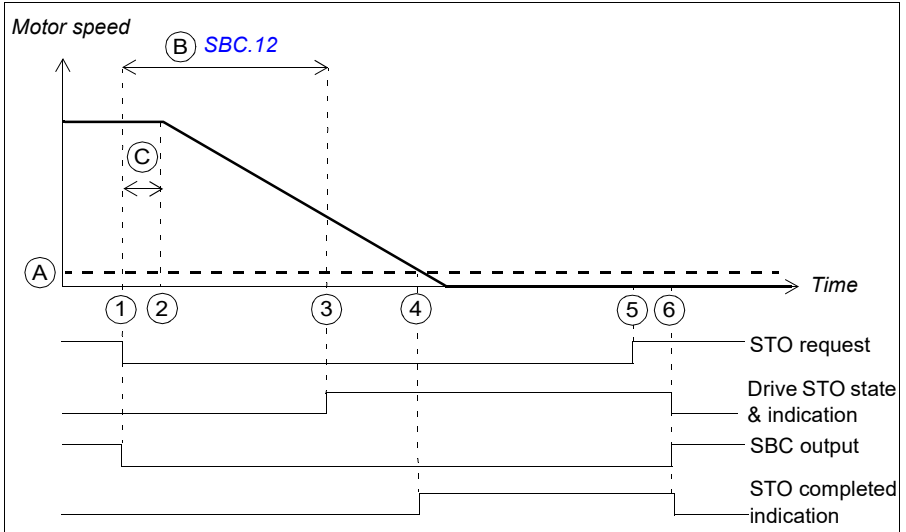

- A Zero speed with encoder (parameter [FSOGEN.52](#)): Speed limit at which the motor has stopped, the safety function is completed and the STO completed indication (parameter [STO.22](#)) goes on. The acknowledgement becomes allowed.
- B SBC delay (parameter [SBC.12](#)): Time from the activation of the drive STO to the moment when the FSO activates the SBC function (brake). In this case the value is negative and the FSO activates the SBC before the drive STO. If the value is zero, the FSO activates the SBC and drive STO functions at the same time.
- C Response time (depends on system configuration, see page [532](#))

Step	Description
1	The STO request is received (for example, from the I/O). The FSO activates the SBC function (brake) and starts a counter for time B. STO active indication parameter STO output (STO.21) goes on.
2	After time C has elapsed, the SBC starts to brake the motor.
3	After time B has elapsed, the FSO activates the drive STO.
4	The motor speed reaches the zero speed limit (A), the FSO module defines the motor as stopped and the STO completed indication goes on. The acknowledgement becomes allowed as soon as the STO request has been removed (step 5).
5	The STO request is removed.
6	After the acknowledgement, the STO and SBC functions are deactivated, and the control is given back to the drive, which controls the brake from now on. The indications STO output (STO.21) and STO completed output (STO.22) go off.

■ STO with speed limit activated SBC

This safety function requires that you use an encoder in the safety application.

The operation of the STO with speed limit activated SBC is described in the time diagram and table below. For configuration, see section [How to configure STO with speed limit activated SBC](#) on page 339.

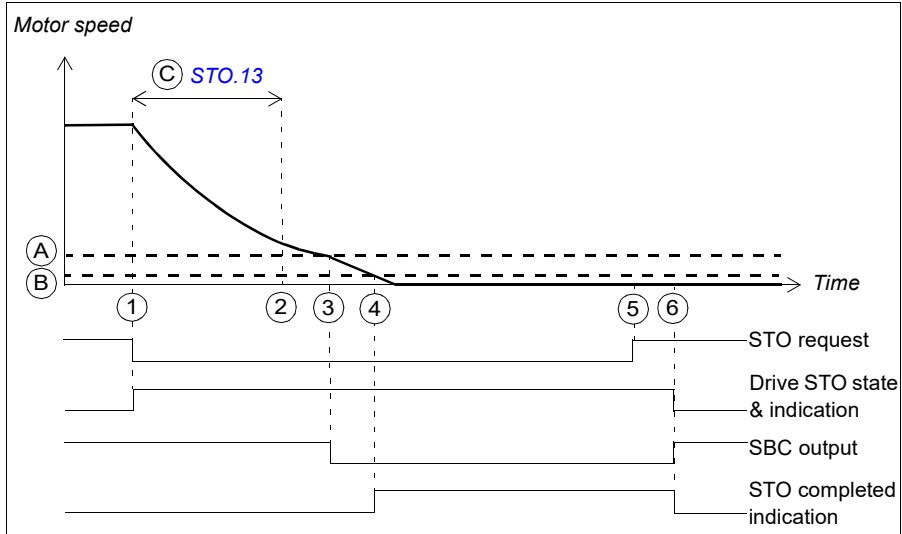

- A STO SBC speed (parameter [SBC.14](#)): Speed limit at which the FSO activates the SBC function (brake).
- B Zero speed with encoder (parameter [FSOGEN.52](#)): Speed limit at which the motor has stopped, the safety function is completed and the STO completed indication (parameter [STO.22](#)) goes on. The acknowledgment becomes allowed.
- C Restart delay after STO (parameter [STO.13](#)): Time from the STO activation to the moment when the acknowledgment becomes allowed. With this parameter, you can allow a restart of the drive before the motor has stopped (fly-start). You can use this feature only in certain applications. This parameter is relevant only when an external request activates the STO function.

Step	Description
1	The STO request is received (for example, from the I/O). The FSO activates the drive STO function. STO active indication parameter STO output (STO.21) goes on.
2	After time C has elapsed, the acknowledgement becomes allowed as soon as the STO request has been removed (step 5).
3	The motor speed goes below the SBC speed limit (A) and the FSO activates the SBC function (brake).
4	The motor speed reaches the zero speed limit (B), the FSO module defines the motor as stopped and the STO completed indication goes on. The acknowledgement becomes allowed despite of value C as soon as the STO request has been removed (step 5).
5	The STO request is removed.
6	After the acknowledgement, the STO and SBC functions are deactivated, and the control is given back to the drive, which controls the brake from now on. The indications STO output (STO.21) and STO completed output (STO.22) go off.

Safe stop 1 (SS1)

The SS1 function stops the motor safely by ramping down the motor speed. The FSO activates the drive STO function below a user-defined zero speed limit.

The FSO monitors the stop ramp either with the time or ramp monitoring method (SS1 function types SS1-t and SS1-r, respectively). If the motor speed does not follow the monitoring limit(s), the FSO activates the STO function and the motor coasts to a stop.

The SS1 function uses SAR1 parameters to define and/or monitor the stop ramp.

When you use the SBC function with the SS1 function, you can configure the SBC and drive STO combination to be activated at a user-defined speed limit while ramping down to zero speed. You can also define a delay so that the SBC is activated first at the user-defined speed limit and the drive STO after the delay.

This section describes the different versions of the SS1 function separately without and with an encoder.

■ SS1 with time monitoring (SS1-t)

The operation of the SS1 with time monitoring (SS1-t) is described in the time diagrams and tables below. For configuration, see section [How to configure SS1 with time monitoring \(SS1-t\)](#) on page 342.

With a safe speed estimate

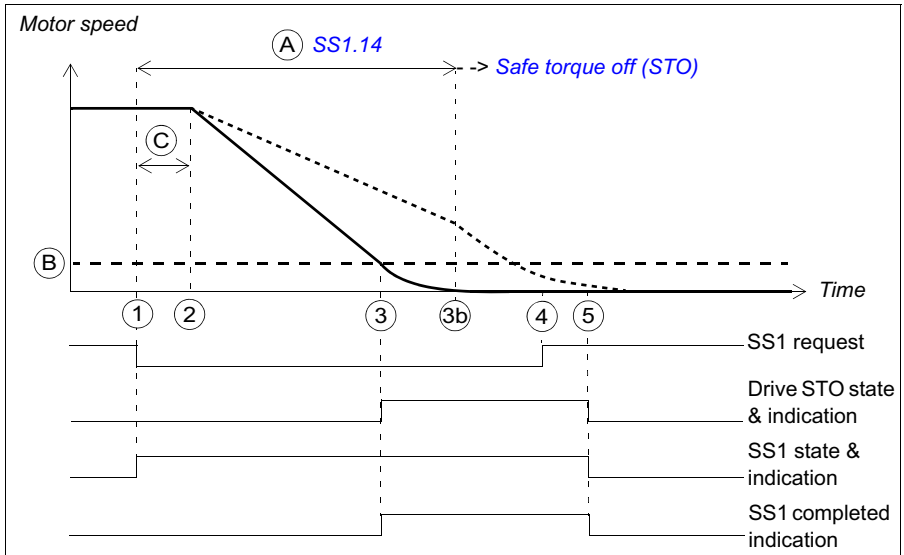

- A SS1-t delay for STO (parameter [SS1.14](#)): Time after which the FSO activates the STO function regardless of the motor speed.
- B Zero speed (parameter [FSOGEN.51](#)): Speed limit for activating the drive STO function. The safety function is completed and the SS1 completed indication (parameter [SS1.22](#)) goes on.
- C Response time (depends on system configuration, see page [532](#))

Step	Description
1	The SS1 request is received (for example, from the I/O). The FSO starts a counter for time A. SS1 active indication parameter <i>SS1 output (SS1.21)</i> goes on.
2	After time C has elapsed, the drive starts to ramp down the motor speed. SAR1 parameter <i>200.112</i> defines the deceleration ramp. Note: If parameter <i>200.112</i> has value 0, the drive (parameter 23.23) defines the ramp.
3	The motor speed reaches the zero speed limit (B), FSO activates the drive STO function and STO active indication parameter STO output (<i>STO.21</i>) goes on. The <i>SS1 completed output</i> indication (parameter <i>SS1.22</i>) goes on and the acknowledgement becomes allowed as soon as the SS1 request has been removed (step 4). Note: If the SBC is configured in the STO function (see section <i>Safe torque off (STO)</i> on page 68), also the SBC is activated (not shown in the figure). <ul style="list-style-type: none"> • If the <i>STO SBC delay</i> (parameter <i>SBC.12</i>) is negative, the SBC is activated here and the drive STO after this delay. • If the <i>STO SBC delay</i> is positive or zero, the SBC and drive STO functions are activated at the same time. • The SS1 completed indication goes on after the delay defined with parameter <i>SBC.13</i> has elapsed from the SBC activation. Note: You can define an extra delay (parameter <i>SS1.15</i>) before the FSO activates the drive STO (and SBC, if used) (not shown in the figure).
3b	If the drive has not decelerated fast enough when time A has elapsed, the FSO activates the STO function. See section <i>Safe torque off (STO)</i> on page 68 for more information on how to configure the STO function.
4	The SS1 request is removed.
5	After the acknowledgement, the STO and SS1 functions are deactivated. The indications <i>SS1 output (SS1.21)</i> , <i>SS1 completed output (SS1.22)</i> , and <i>STO output (STO.21)</i> go off.

With an encoder

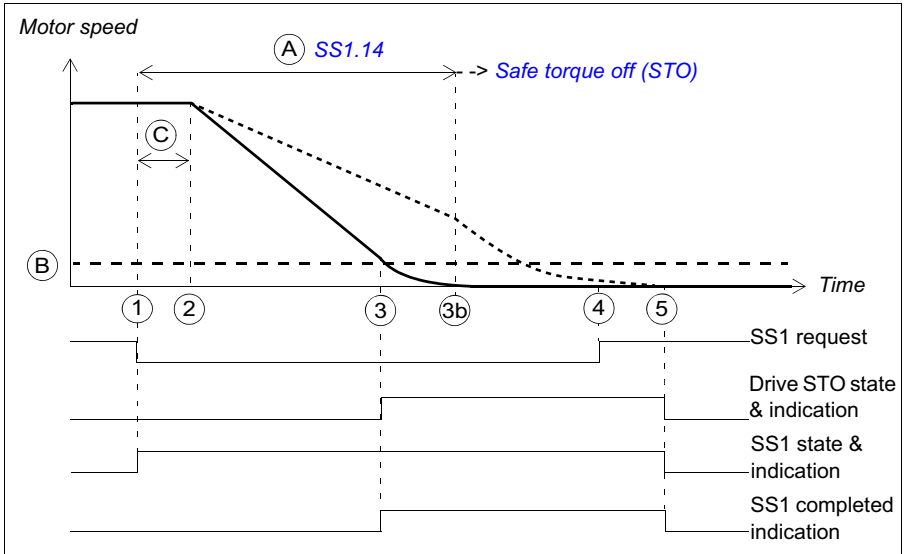

- A SS1-t delay for STO (parameter [SS1.14](#)): Time after which the FSO activates the STO function regardless of the motor speed.
- B Zero speed with encoder (parameter [FSOGEN.52](#)): Speed limit for activating the drive STO function. The safety function is completed and the SS1 completed indication (parameter [SS1.22](#)) goes on. The acknowledgment becomes allowed.
- C Response time (depends on system configuration, see page [532](#))

Step	Description
1	The SS1 request is received (for example from the I/O). The FSO starts a counter for time A. SS1 state indication parameter <i>SS1 output (SS1.21)</i> goes on.
2	After time C has elapsed, the drive starts to ramp down the motor speed. SAR1 parameter <i>200.112</i> defines the deceleration ramp. Note: If parameter <i>200.112</i> has value 0, the drive (parameter 23.23) defines the ramp.
3	The motor speed reaches the zero speed limit (B), the FSO activates the drive STO function and STO active indication parameter STO output (<i>STO.21</i>) goes on. The <i>SS1 completed output</i> indication (parameter <i>SS1.22</i>) goes on and the acknowledgement becomes allowed as soon as the SS1 request has been removed (step 4). Note: If the SBC is configured in the STO function (see section <i>Safe torque off (STO)</i> on page 68), also the SBC is activated (not shown in the figure). <ul style="list-style-type: none"> • If the <i>STO SBC delay</i> (parameter <i>SBC.12</i>) is negative, the SBC is activated here and the drive STO after this delay. • If the <i>STO SBC delay</i> is positive or zero, the SBC and drive STO functions are activated at the same time. Note: You can define an extra delay (parameter <i>SS1.15</i>) before the FSO activates the drive STO (and SBC, if used) (not shown in the figure).
3b	If the drive has not ramped down fast enough when time A has elapsed, the FSO activates the STO function. See section <i>Safe torque off (STO)</i> on page 68 for more information on how to configure the STO function.
4	The SS1 request is removed.
5	After the acknowledgement, the STO and SS1 functions are deactivated. The indications <i>SS1 output (SS1.21)</i> , <i>SS1 completed output (SS1.22)</i> , and <i>STO output (STO.21)</i> go off.

■ **SS1 with ramp monitoring (SS1-r)**

The operation of the SS1 with ramp monitoring (SS1-r) is described in the time diagrams and tables below. For configuration, see section [How to configure SS1 with ramp monitoring \(SS1-r\)](#) on page 344.

With a safe speed estimate

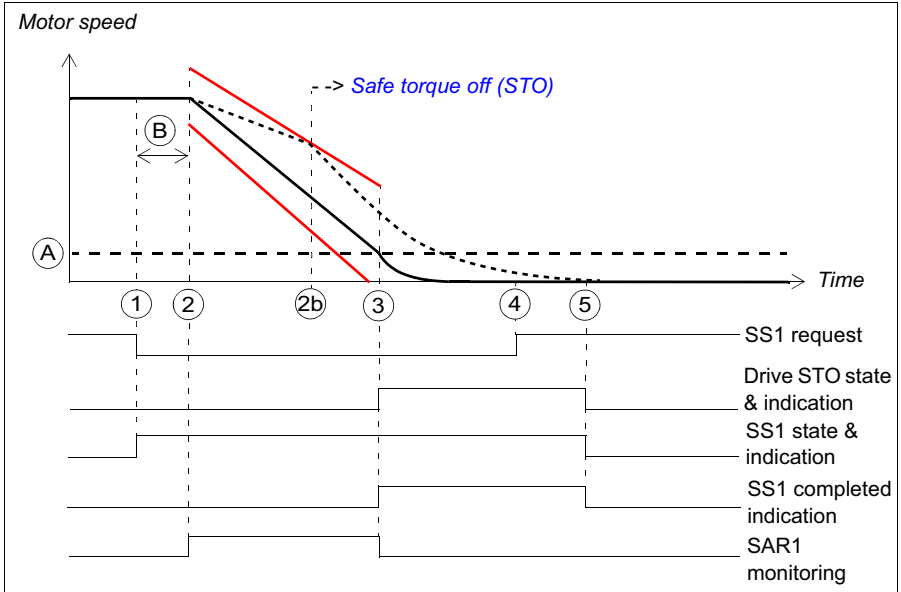

- A Zero speed (parameter [FSOGEN.51](#)): Speed limit for activating the drive STO function. The safety function is completed and the SS1 completed indication (parameter [SS1.22](#)) goes on. The acknowledgment becomes allowed.

- B Response time (depends on system configuration, see page 532)

— Ramp monitoring limits

Step	Description
1	The SS1 request is received (for example, from the I/O).
2	<p>After time B has elapsed, the drive starts to ramp down the motor speed. SAR1 parameter 200.112 defines the deceleration ramp. The FSO starts the SAR1 ramp monitoring (parameters SARx.21 and SARx.22).</p> <p>Note: If parameter 200.112 has value 0, the drive (parameter 23.23) defines the ramp.</p>
2b	If the motor speed hits a ramp monitoring limit, the FSO activates the STO function. See section Safe torque off (STO) on page 68 for more information on how to configure the STO function.
3	<p>The motor speed reaches the zero speed limit (B), FSO stops the SAR1 monitoring and activates the drive STO function, and STO active indication parameter STO output (STO.21) goes on. The SS1 completed output indication (parameter SS1.22) goes on and the acknowledgement becomes allowed as soon as the SS1 request has been removed (step 4).</p> <p>Note: If the SBC is configured in the STO function (see section Safe torque off (STO) on page 68), also the SBC is activated (not shown in the figure).</p> <ul style="list-style-type: none"> • If the STO SBC delay (parameter SBC.12) is negative, the SBC is activated here and the drive STO after this delay. • If the STO SBC delay is positive or zero, the SBC and drive STO functions are activated at the same time. • The SS1 completed indication goes on after the delay defined with parameter SBC.13 has elapsed from the SBC activation. <p>Note: You can define an extra delay (parameter SS1.15) before the FSO activates the drive STO (and SBC, if used) (not shown in the figure).</p>
4	The SS1 request is removed.
5	After the acknowledgement, the STO and SS1 functions are deactivated and the control is given back to the drive, which is allowed to modulate again. The indications SS1 output (SS1.21) , SS1 completed output (SS1.22) , and STO output (STO.21) go off.

With an encoder

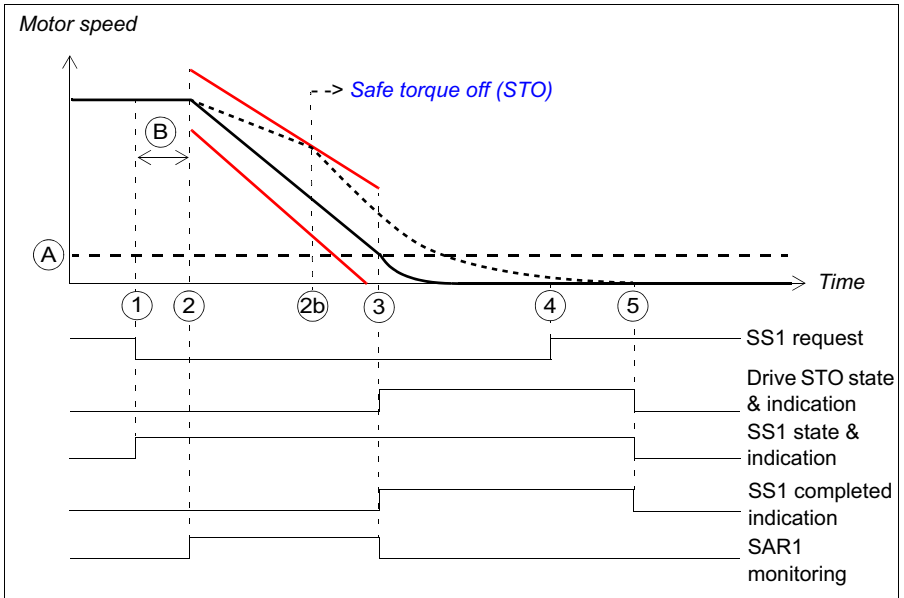

- A Zero speed with encoder (parameter [FSOGEN.52](#)): Speed limit for activating the drive STO function. The safety function is completed, ramp monitoring is stopped and the SS1 completed indication (parameter [SS1.22](#)) goes on. The acknowledgment becomes allowed.
- B Response time (depends on system configuration, see page [532](#))
- Ramp monitoring limits

Step	Description
1	The SS1 request is received (for example, from the I/O).
2	<p>After time B has elapsed, the drive starts to ramp down the motor speed. SAR1 parameter 200.112 defines the deceleration ramp. The FSO starts the SAR1 ramp monitoring (parameters SARx.21 and SARx.22).</p> <p>Note: If parameter 200.112 has value 0, the drive (parameter 23.23) defines the ramp.</p>
2b	<p>If the motor speed hits a ramp monitoring limit, the FSO activates the STO function. See section Safe torque off (STO) on page 68 for more information on how to configure the STO function.</p>
3	<p>The motor speed reaches the zero speed limit (A), FSO stops the SAR1 monitoring and activates the drive STO function, and STO active indication parameter STO output (STO.21) goes on. The SS1 completed output indication (parameter SS1.22) goes on and the acknowledgement becomes allowed as soon as the SS1 request has been removed (step 4).</p> <p>Note: If the SBC is configured in the STO function (see section Safe torque off (STO) on page 68), also the SBC is activated (not shown in the figure).</p> <ul style="list-style-type: none"> • If the STO SBC delay (parameter SBC.12) is negative, the SBC is activated here and the drive STO after this delay. • If the STO SBC delay is positive or zero, the SBC and drive STO functions are activated at the same time. <p>Note: You can define an extra delay (parameter SS1.15) before the FSO activates the drive STO (and SBC, if used) (not shown in the figure).</p>
4	The SS1 request is removed.
5	<p>After the acknowledgement, the STO and SS1 functions are deactivated and the control is given back to the drive, which is allowed to modulate again. The indications SS1 output (SS1.21), SS1 completed output (SS1.22), and STO output (STO.21) go off.</p>

■ SS1 with speed limit activated SBC

In these examples, the SBC and drive STO functions are activated at a user-defined speed limit.

With time monitoring (SS1-t)

The operation of the SS1-t function with speed limit activated SBC is described in the time diagrams and tables below. For configuration, see section [How to configure SS1 with speed limit activated SBC](#) on page 345.

With a safe speed estimate

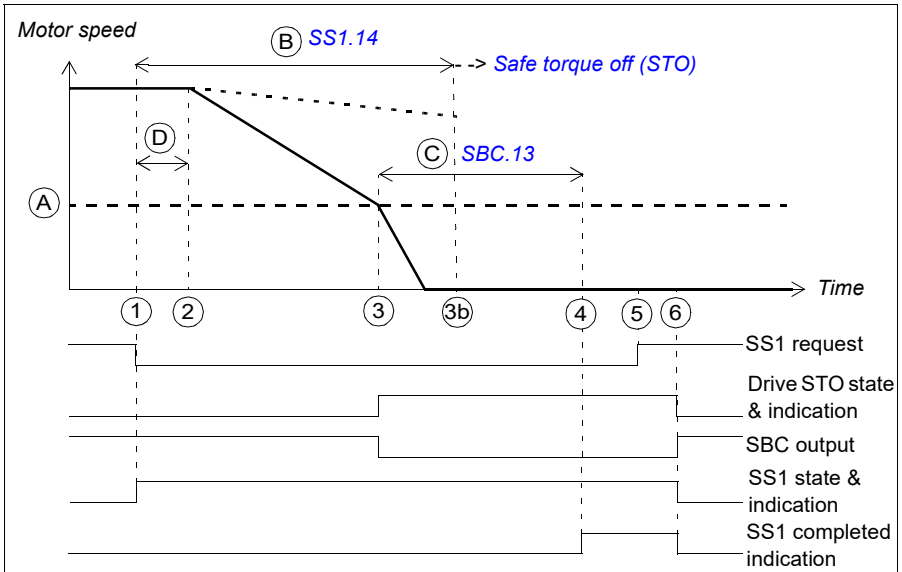

- A SBC speed (parameter [SBC.15](#)): Speed limit below which the FSO activates the SBC (brake) and drive STO functions while ramping.
- B SS1-t delay for STO (parameter [SS1.14](#)): Time after which the FSO activates the STO function regardless of the motor speed.
- C SBC time to zero (parameter [SBC.13](#)): Time from the SBC activation to the moment when the safety function is completed and the SS1 completed indication (parameter [SS1.22](#)) goes on. The acknowledgment becomes allowed. You must set this to the estimated time in which the motor brakes to a stop from the maximum speed.
- D Response time (depends on system configuration, see page [532](#))

Step	Description
1	The SS1 request is received (for example, from the I/O). The FSO starts a counter for time B. SS1 state indication parameter <i>SS1 output (SS1.21)</i> goes on.
2	After time D has elapsed, the drive starts to ramp down the motor speed. SAR1 parameter <i>200.112</i> defines the deceleration ramp. Note: If parameter <i>200.112</i> has value 0, the drive (parameter <i>23.23</i>) defines the ramp.
3	The motor speed goes below the SBC speed limit (A), the FSO checks the value of <i>STO SBC delay</i> (parameter <i>SBC.12</i>) and activates the SBC and drive STO functions: <ul style="list-style-type: none"> • If the <i>STO SBC delay</i> is positive or zero, the SBC and drive STO functions are activated at the same time (this case is shown in the figure). • If the <i>STO SBC delay</i> is negative, the SBC is activated here and the drive STO after this delay (see section <i>SS1 with speed limit activated SBC, SBC before STO</i> on page 97). • STO active indication parameter <i>STO output (STO.21)</i> goes on when STO is activated. The FSO starts a counter for time C. Note: You can define an extra delay (parameter <i>SS1.15</i>) before the FSO activates the SBC and drive STO functions (not shown in the figure).
3b	If the drive has not ramped down fast enough when time B has elapsed, the FSO activates the STO function. See section <i>Safe torque off (STO)</i> on page 68 for more information on how to configure the STO function.
4	After time C has elapsed, the FSO defines the motor as stopped, the <i>SS1 completed output</i> indication (parameter <i>SS1.22</i>) goes on and the acknowledgement becomes allowed as soon as the SS1 request has been removed (step 5).
5	The SS1 request is removed.
6	After the acknowledgement, the SS1, STO and SBC functions are deactivated and the control is given back to the drive, which is allowed to modulate again. The indications <i>SS1 output (SS1.21)</i> , <i>SS1 completed output (SS1.22)</i> , and <i>STO output (STO.21)</i> go off.

With an encoder

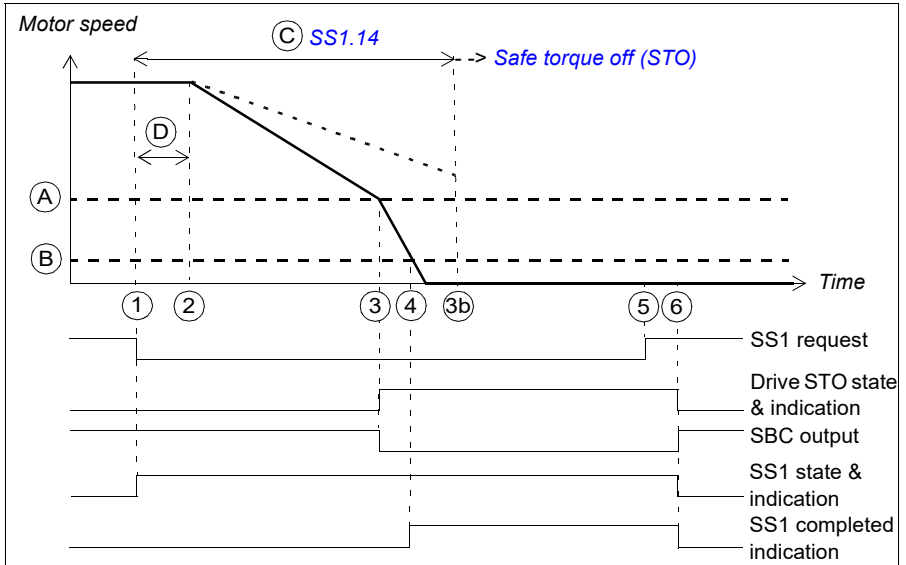

- A SBC speed (parameter [SBC.15](#)): Speed limit below which the FSO activates the SBC (brake) and drive STO functions while ramping.
- B Zero speed with encoder (parameter [FSOGEN.52](#)): Speed limit to define the motor as stopped. The safety function is completed and the SS1 completed indication (parameter [SS1.22](#)) goes on. The acknowledgment becomes allowed.
- C SS1-t delay for STO (parameter [SS1.14](#)): Time after which the FSO activates the STO function regardless of the motor speed.
- D Response time (depends on system configuration, see page [532](#))

Step	Description
1	The SS1 request is received (for example, from the I/O). The FSO starts a counter for time C. SS1 state indication parameter <i>SS1 output (SS1.21)</i> goes on.
2	After time D has elapsed, the drive starts to ramp down the motor speed. SAR1 parameter <i>200.112</i> defines the deceleration ramp. Note: If parameter <i>200.112</i> has value 0, the drive (parameter 23.23) defines the ramp.
3	The motor speed goes below the SBC speed limit (A), the FSO checks the value of <i>STO SBC delay</i> (parameter <i>SBC.12</i>) and activates the SBC and drive STO functions: <ul style="list-style-type: none"> • If the <i>STO SBC delay</i> is positive or zero, the SBC and drive STO functions are activated at the same time (this case is shown in the figure). • If the <i>STO SBC delay</i> is negative, the SBC is activated here and the drive STO after this delay (see section <i>SS1 with speed limit activated SBC, SBC before STO</i> on page 97). • STO active indication parameter <i>STO output (STO.21)</i> goes on when STO is activated. Note: You can define an extra delay (parameter <i>SS1.15</i>) before the FSO activates the SBC and drive STO functions (not shown in the figure).
3b	If the drive has not ramped down fast enough when time C has elapsed, the FSO activates the STO function. See section <i>Safe torque off (STO)</i> on page 68 for more information on how to configure the STO function.
4	The motor speed reaches the zero speed limit (B), the FSO defines the motor as stopped, the <i>SS1 completed output</i> indication (parameter <i>SS1.22</i>) goes on and the acknowledgement becomes allowed as soon as the SS1 request has been removed (step 5).
5	The SS1 request is removed.
6	After the acknowledgement, the SS1, STO and SBC functions are deactivated, and the control is given back to the drive, which is allowed to modulate again. The indications <i>SS1 output (SS1.21)</i> , <i>SS1 completed output (SS1.22)</i> , and <i>STO output (STO.21)</i> go off.

With ramp monitoring (SS1-r)

The operation of the SS1-r function with speed limit activated SBC is described in the time diagrams and tables below. For configuration, see section [How to configure SS1 with speed limit activated SBC](#) on page 345.

With a safe speed estimate

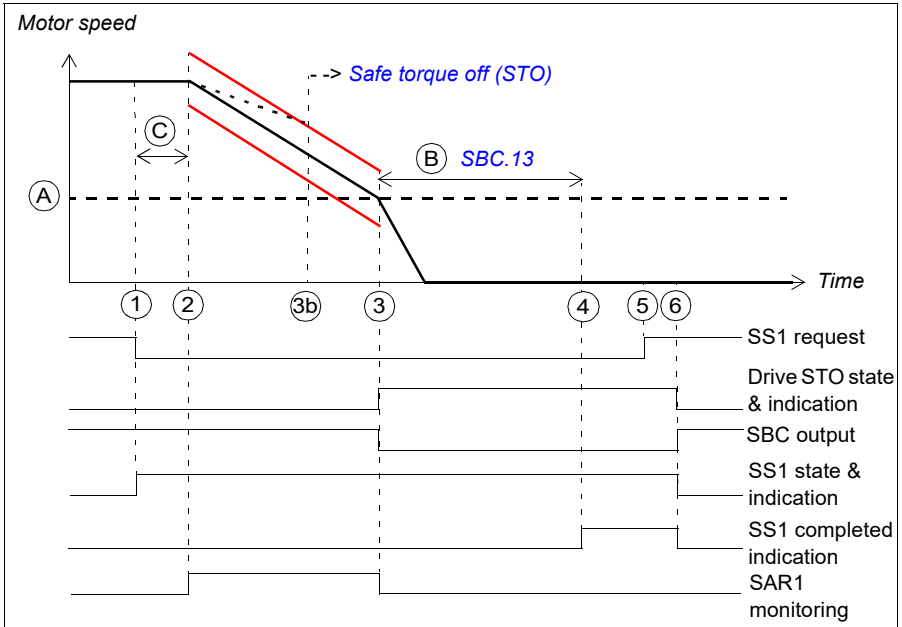

- A SBC speed (parameter [SBC.15](#)): Speed limit below which the FSO activates the SBC (brake) and drive STO functions while ramping.
- B SBC time to zero (parameter [SBC.13](#)): Time from the SBC activation to the moment when the safety function is completed and the SS1 completed indication (parameter [SS1.22](#)) goes on. The acknowledgment becomes allowed. You must set this to the estimated time in which the motor brakes to a stop from the maximum speed.
- C Response time (depends on system configuration, see page [532](#))
- Ramp monitoring limits

Step	Description
1	The SS1 request is received (for example, from the I/O).
2	<p>After time C has elapsed, the drive starts to ramp down the motor speed. SAR1 parameter 200.112 defines the deceleration ramp. The FSO starts the SAR1 ramp monitoring (parameters SARx.21 and SARx.22).</p> <p>Note: If parameter 200.112 has value 0, the drive (parameter 23.23) defines the ramp.</p>
3	<p>The motor speed goes below the SBC speed limit (A), the FSO stops the SAR1 monitoring. The FSO checks the value of STO SBC delay (parameter SBC.12) and activates the SBC and drive STO functions:</p> <ul style="list-style-type: none"> • If the STO SBC delay is positive or zero, the SBC and drive STO functions are activated at the same time (this case is shown in the figure). • If the STO SBC delay is negative, the SBC is activated here and the drive STO after this delay (see section SS1 with speed limit activated SBC, SBC before STO on page 97.) • STO active indication parameter STO output (STO.21) goes on when STO is activated. <p>The FSO starts a counter for time B.</p> <p>Note: You can define an extra delay (parameter SS1.15) before the FSO activates the SBC and drive STO functions (not shown in the figure).</p>
3b	If the motor speed hits a ramp monitoring limit, the FSO activates the STO function. See section Safe torque off (STO) on page 68 for more information on how to configure the STO function.
4	After time B has elapsed, the FSO defines the motor as stopped, the SS1 completed output indication (parameter SS1.22) goes on and the acknowledgement becomes allowed as soon as the SS1 request has been removed (step 5).
5	The SS1 request is removed.
6	After the acknowledgement, the SS1, STO and SBC functions are deactivated and the control is given back to the drive, which is allowed to modulate again. The indications SS1 output (SS1.21), SS1 completed output (SS1.22), and STO output (STO.21) go off.

With an encoder

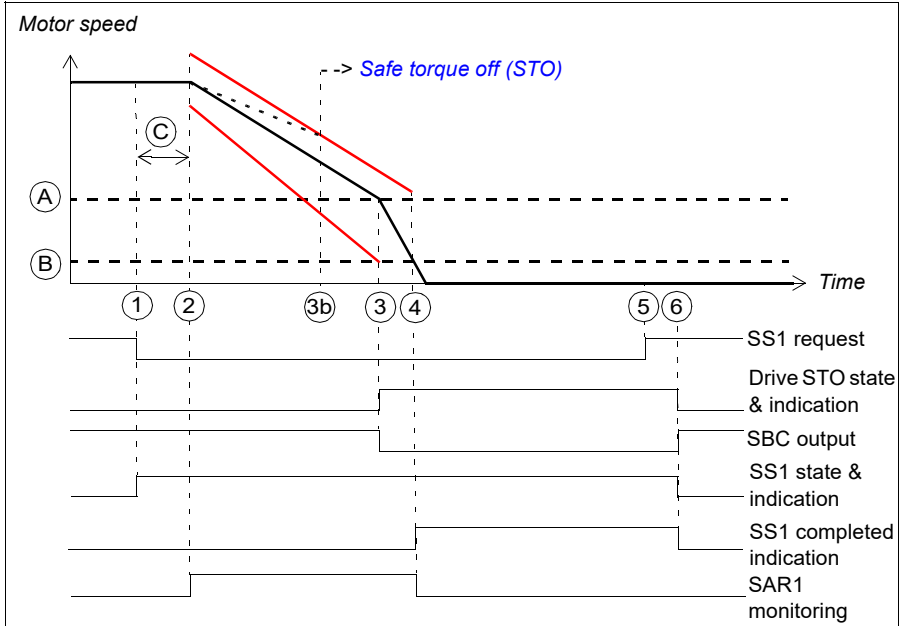

- A SBC speed (parameter [SBC.15](#)): Speed limit below which FSO activates the SBC (brake) and drive STO functions while ramping.
- B Zero speed with encoder (parameter [FSOGEN.52](#)): Speed limit to define the motor as stopped. The safety function is completed, the ramp monitoring is stopped and the SS1 completed indication (parameter [SS1.22](#)) goes on. The acknowledgment becomes allowed.
- C Response time (depends on system configuration, see page [532](#))
- Ramp monitoring limits

Step	Description
1	The SS1 request is received (for example, from the I/O).
2	<p>After time B has elapsed, the drive starts to ramp down the motor speed. SAR1 parameter 200.112 defines the deceleration ramp. The FSO starts the SAR1 ramp monitoring (parameters SARx.21 and SARx.22).</p> <p>Note: If parameter 200.112 has value 0, the drive (parameter 23.23) defines the ramp.</p>
3	<p>The motor speed goes below the SBC speed limit (A). The FSO checks the value of STO SBC delay (parameter SBC.12) and activates the SBC and drive STO functions:</p> <ul style="list-style-type: none"> • If the STO SBC delay is positive or zero, the SBC and drive STO functions are activated at the same time (this case is shown in the figure). • If the STO SBC delay is negative, the SBC is activated here and the drive STO after this delay (see section SS1 with speed limit activated SBC, SBC before STO on page 97). • STO active indication parameter STO output (STO.21) goes on when STO is activated. <p>Note: You can define an extra delay (parameter SS1.15) before the FSO activates the SBC and drive STO functions (not shown in the figure).</p>
3b	If the motor speed hits a ramp monitoring limit, the FSO activates the STO function. See section Safe torque off (STO) on page 68 for more information on how to configure the STO function.
4	The motor speed reaches the zero speed limit (B), the FSO defines the motor as stopped, the SS1 completed output indication (parameter SS1.22) goes on and the acknowledgement becomes allowed as soon as the SS1 request has been removed (step 5). The FSO stops the SAR1 monitoring.
5	The SS1 request is removed.
6	After the acknowledgement, the SS1, STO and SBC functions are deactivated and the control is given back to the drive, which is allowed to modulate again. The indications SS1 output (SS1.21) , SS1 completed output (SS1.22) , and STO output (STO.21) go off.

■ SS1 with speed limit activated SBC, SBC before STO

In these examples, the SBC function is activated at a user-defined speed limit and drive STO function after a user-defined delay (negative SBC delay). The reason to use a negative SBC delay (parameter [SBC.12](#)) is to have the mechanical brake closed just before the drive STO circuit is opened.

With time monitoring (SS1-t)

The operation of the SS1-t function with speed limit activated SBC, SBC before STO is described in the time diagrams and tables below. For configuration, see section [How to configure SS1 with speed limit activated SBC, SBC before STO](#) on page 349.

With a safe speed estimate

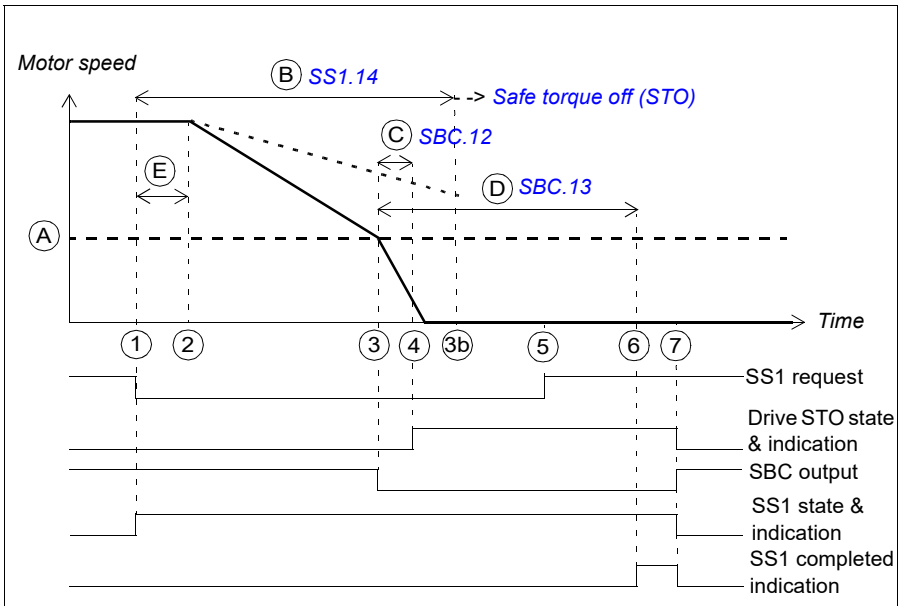

- A SBC speed (parameter [SBC.15](#)): Speed limit below which the FSO activates the SBC (brake).
- B SS1-t delay for STO (parameter [SS1.14](#)): Time after which the FSO activates the STO function regardless of the motor speed.
- C SBC delay (parameter [SBC.12](#)): Time from the activation of the SBC function to the moment when the FSO activates the drive STO function.
- D SBC time to zero (parameter [SBC.13](#)): Time from the SBC activation to the moment when the safety function is completed and the SS1 completed indication (parameter [SS1.22](#)) goes on. The acknowledgment becomes allowed. You must set this to the estimated time in which the motor brakes to a stop from the maximum speed.
- E Response time (depends on system configuration, see page 532)

Step	Description
1	The SS1 request is received (for example, from the I/O). The FSO starts a counter for time B. SS1 state indication parameter <i>SS1 output (SS1.21)</i> goes on.
2	After time E has elapsed, the drive starts to ramp down the motor speed. SAR1 parameter <i>200.112</i> defines the deceleration ramp. Note: If parameter <i>200.112</i> has value 0, the drive (parameter 23.23) defines the ramp.
3	The motor speed goes below the SBC speed limit (A), the FSO activates SBC function. The FSO starts counters for times C and D. Note: You can define an extra delay (parameter <i>SS1.15</i> , not shown in the figure) before the FSO activates the SBC function. This affects also the STO activation (step 4).
3b	If the drive has not ramped down fast enough when time B has elapsed, the FSO activates the STO function. See section <i>Safe torque off (STO)</i> on page 68 for more information on how to configure the STO function.
4	After time C has elapsed, the FSO activates the drive STO function. STO active indication parameter <i>STO output (STO.21)</i> goes on when STO is activated.
5	The SS1 request is removed.
6	After time D has elapsed, the FSO defines the motor as stopped, the <i>SS1 completed output</i> indication (parameter <i>SS1.22</i>) goes on and the acknowledgement becomes allowed as soon as the SS1 request has been removed (step 5).
7	After the acknowledgement, the SS1, STO and SBC functions are deactivated and the control is given back to the drive, which is allowed to modulate again. The indications <i>SS1 output (SS1.21)</i> , <i>SS1 completed output (SS1.22)</i> , and <i>STO output (STO.21)</i> go off.

With an encoder

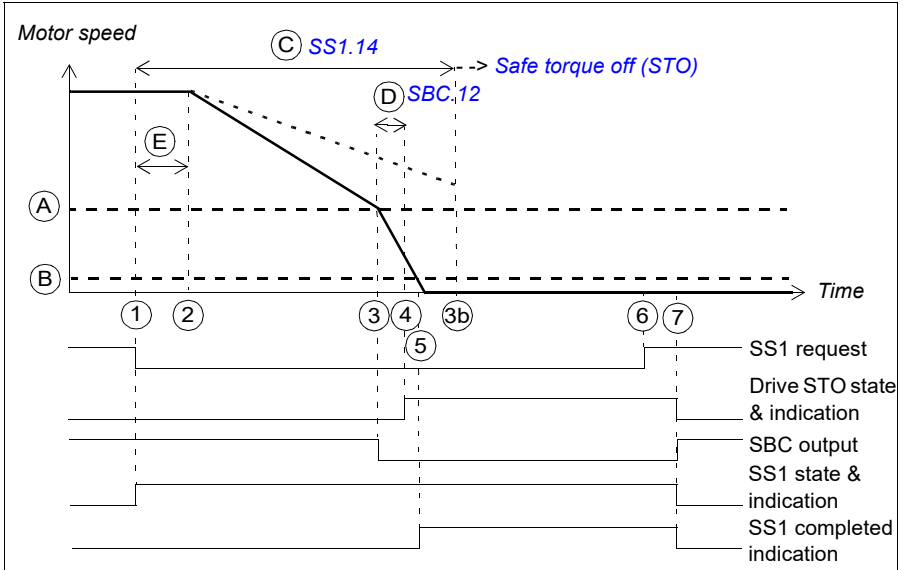

- A SBC speed (parameter [SBC.15](#)): Speed limit below which the FSO activates the SBC (brake).
- B Zero speed with encoder (parameter [FSOGEN.52](#)): Speed limit to define the motor as stopped. The safety function is completed and the SS1 completed indication (parameter [SS1.22](#)) goes on. The acknowledgment becomes allowed.
- C SS1-t delay for STO (parameter [SS1.14](#)): Time after which the FSO activates the STO function regardless of the motor speed.
- D SBC delay (parameter [SBC.12](#)): Time from the activation of the SBC function to the moment when the FSO activates the drive STO function.
- E Response time (depends on system configuration, see page [532](#))

Step	Description
1	The SS1 request is received (for example, from the I/O). The FSO starts a counter for time C. SS1 state indication parameter <i>SS1 output (SS1.21)</i> goes on.
2	After time E has elapsed, the drive starts to ramp down the motor speed. SAR1 parameter <i>200.112</i> defines the deceleration ramp. Note: If parameter <i>200.112</i> has value 0, the drive (parameter 23.23) defines the ramp.
3	The motor speed goes below the SBC speed limit (A), the FSO activates SBC function. The FSO starts a counter for time D. Note: You can define an extra delay (parameter <i>SS1.15</i> , not shown in the figure) before the FSO activates the SBC function. This affects also the STO activation (step 4).
3b	If the drive has not ramped down fast enough when time C has elapsed, the FSO activates the STO function. See section <i>Safe torque off (STO)</i> on page 68 for more information on how to configure the STO function.
4	After time D has elapsed, the FSO activates the drive STO function. STO active indication parameter <i>STO output (STO.21)</i> goes on when STO is activated.
5	The motor speed reaches the zero speed limit (B), the FSO defines the motor as stopped, the <i>SS1 completed output</i> indication (parameter <i>SS1.22</i>) goes on and the acknowledgement becomes allowed as soon as the SS1 request has been removed (step 6).
6	The SS1 request is removed.
7	After the acknowledgement, the SS1, STO and SBC functions are deactivated and the control is given back to the drive, which is allowed to modulate again. The indications <i>SS1 output (SS1.21)</i> , <i>SS1 completed output (SS1.22)</i> , and <i>STO output (STO.21)</i> go off.

With ramp monitoring (SS1-r)

The operation of the SS1-r function with speed limit activated SBC, SBC before STO is described in the time diagrams and tables below. For configuration, see section [How to configure SS1 with speed limit activated SBC, SBC before STO](#) on page 349.

With a safe speed estimate

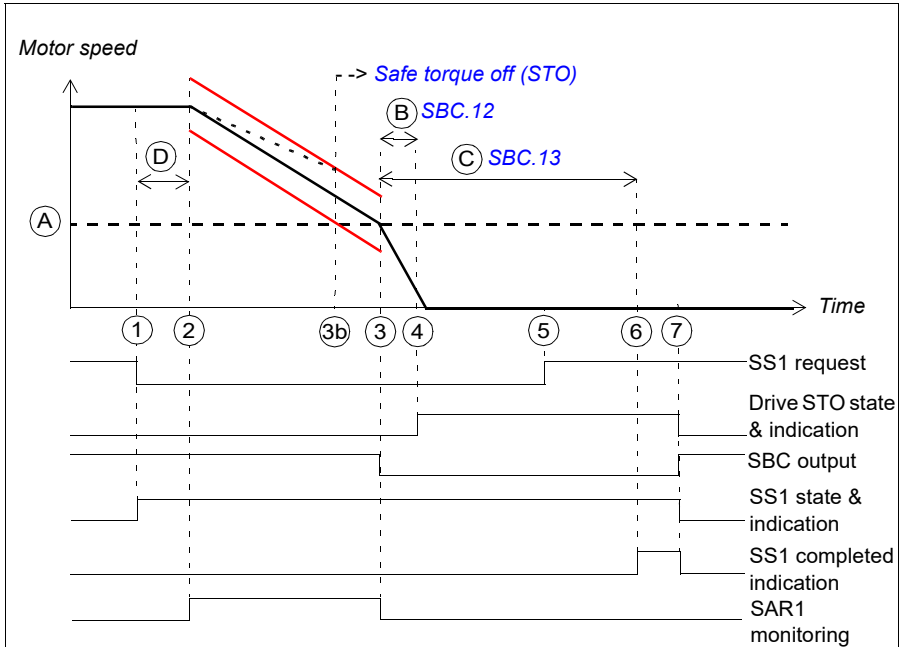

- A SBC speed (parameter [SBC.15](#)): Speed limit below which the FSO activates the SBC function (brake) while ramping. The SAR1 ramp monitoring is stopped.
 - B SBC delay (parameter [SBC.12](#)): Time from the activation of the SBC function to the moment when the FSO activates the drive STO function.
 - C SBC time to zero (parameter [SBC.13](#)): Time from the SBC activation to the moment when the safety function is completed and the SS1 completed indication (parameter [SS1.22](#)) goes on. The acknowledgment becomes allowed. You must set this to the estimated time in which the motor brakes to a stop from the maximum speed.
 - D Response time (depends on system configuration, see page [532](#))
- Ramp monitoring limits

Step	Description
1	The SS1 request is received (for example, from the I/O).
2	After time D has elapsed, the drive starts to ramp down the motor speed. SAR1 parameter 200.112 defines the deceleration ramp. The FSO starts the SAR1 ramp monitoring (parameters SARx.21 and SARx.22). Note: If parameter 200.112 has value 0, the drive (parameter 23.23) defines the ramp.
3	The motor speed goes below the SBC speed limit (A), the FSO stops the SAR1 monitoring and activates the SBC function. The FSO starts counters for times B and C. Note: You can define an extra delay (parameter SS1.15 , not shown in the figure) before the FSO activates the SBC function. This affects also the STO activation (step 4).
3b	If the motor speed hits a ramp monitoring limit, the FSO activates the STO function. See section Safe torque off (STO) on page 68 for more information on how to configure the STO function.
4	After time B has elapsed, the FSO activates the drive STO function. STO active indication parameter STO output (STO.21) goes on when STO is activated.
5	The SS1 request is removed.
6	After time C has elapsed, the FSO defines the motor as stopped, the SS1 completed output indication (parameter SS1.22) goes on and the acknowledgement becomes allowed as soon as the SS1 request has been removed (step 5).
7	After the acknowledgement, the SS1, STO and SBC functions are deactivated and the control is given back to the drive, which is allowed to modulate again. The indications SS1 output (SS1.21) , SS1 completed output (SS1.22) , and STO output (STO.21) go off.

With an encoder

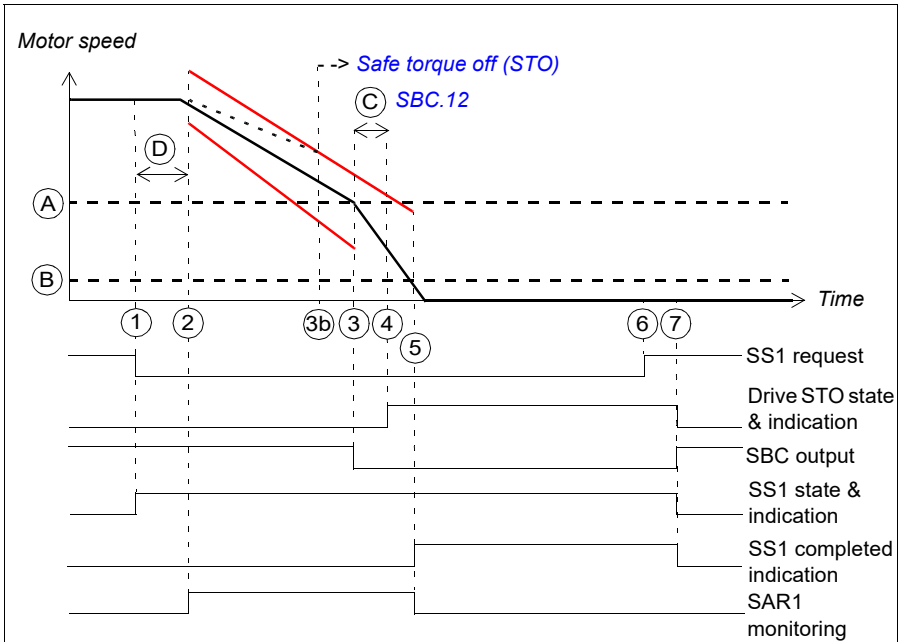

- A SBC speed (parameter [SBC.15](#)): Speed limit below which FSO activates the SBC function (brake) while ramping.
 - B Zero speed with encoder (parameter [FSOGEN.52](#)): Speed limit to define the motor as stopped. The safety function is completed, the SAR1 ramp monitoring is stopped and the SS1 completed indication (parameter [SS1.22](#)) goes on. The acknowledgment becomes allowed.
 - C SBC delay (parameter [SBC.12](#)): Time from the activation of the SBC function to the moment when the FSO activates the drive STO function.
 - D Response time (depends on system configuration, see page [532](#))
- Ramp monitoring limits

Step	Description
1	The SS1 request is received (for example, from the I/O).
2	After time D has elapsed, the drive starts to ramp down the motor speed. SAR1 parameter 200.112 defines the deceleration ramp. The FSO starts the SAR1 ramp monitoring (parameters SARx.21 and SARx.22). Note: If parameter 200.112 has value 0, the drive (parameter 23.23) defines the ramp.
3	The motor speed goes below the SBC speed limit (A). The FSO activates the SBC function. The FSO starts a counter for time C. Note: You can define an extra delay (parameter SS1.15 , not shown in the figure) before the FSO activates the SBC function. This affects also the STO activation (step 4).
3b	If the motor speed hits a ramp monitoring limit, the FSO activates the STO function. See section Safe torque off (STO) on page 68 for more information on how to configure the STO function.
4	After time C has elapsed, the FSO activates the drive STO function. STO active indication parameter STO output (STO.21) goes on when STO is activated.
5	The motor speed reaches the zero speed limit (B), the FSO defines the motor as stopped and stops the SAR1 monitoring. The SS1 completed output indication (parameter SS1.22) goes on and the acknowledgement becomes allowed as soon as the SS1 request has been removed (step 6).
6	The SS1 request is removed.
7	After the acknowledgement, the SS1, STO and SBC functions are deactivated and the control is given back to the drive, which is allowed to modulate again. The indications SS1 output (SS1.21) , SS1 completed output (SS1.22) , and STO output (STO.21) go off.

■ SS1 ramp functions when drive modulation is lost

The operation of SS1-r and -t functions in a situation where drive modulation is lost during the deceleration ramp is described below.

The operation of SSE function in this situation is otherwise similar, but SSE indications are shown instead of SS1 indications.

With safe speed estimation

With both SS1-r and SS1-t, STO function is activated right away when the modulation is lost but the SS1 indications are operational. STO cascading is not activated in this case. The completed indication of the STO function is not indicated ([SS1.22](#)), instead the SS1 completed indication ([SS1.22](#)) is activated. Otherwise STO function (and SBC, if in use) behaves as configured.

With safety encoder

The lost of modulation does not affect to the behaviour of these functions when they are used with safety encoder. See the behaviour in section [SS1 with ramp monitoring \(SS1-r\)](#) on page 85 or [SS1 with time monitoring \(SS1-t\)](#) on page 81.

With a safe speed estimate

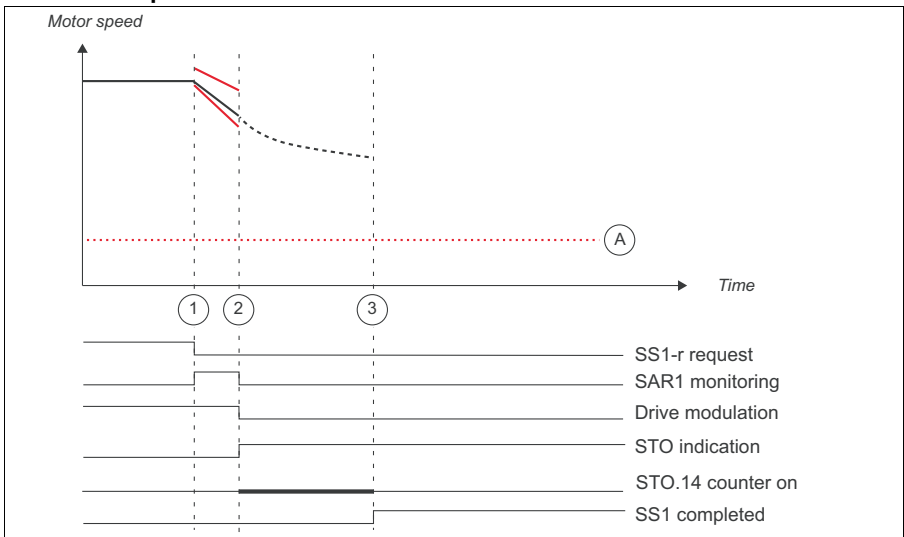

A Zero speed (parameter [FSOGEN.51](#))

Step	Description
1	<p>The SS1 request is received (for example, from the I/O). The drive starts to ramp down the motor speed. SAR1 parameter 200.112 defines the deceleration ramp. The FSO starts the SAR1 ramp monitoring (parameters SARx.21 and SARx.22).</p> <p>Note: If parameter 200.112 has value 0, the drive (parameter 23.23) defines the ramp.</p>
2	<p>The drive trips on a fault or user stops the drive, modulation of the drive stops. FSO module activates the STO function and STO indication (parameter STO.21 STO output).</p> <p>SAR1 ramp monitoring goes off.</p> <p>See section Safe torque off (STO) on page 68 for more information on how to configure the STO function.</p> <p>Note: If STO is used in cascaded system (see Cascade on page 63), it will not be activated in the whole system in this case.</p> <p>Note: SS1 completed indication (SS1.22) is used instead of STO completed indication (STO.22) in this case</p> <p>Note: If the SBC is configured in the STO function, also the SBC is activated according to the configuration (not shown in the figure).</p>
3	<p>The SS1 completed output indication (parameter SS1.22) goes on and the acknowledgement becomes allowed as soon as the SS1 request has been removed.</p> <p>SS1 function can be acknowledged when STO.14 delay has elapsed after the drive modulation is lost.</p>

Safe stop emergency (SSE)

The SSE function can be configured either with immediate STO or with emergency ramp.

With immediate STO

The behavior of the SSE with immediate STO is identical to the STO function (see section [Safe torque off \(STO\)](#) on page 68) except that parameter [Restart delay after STO](#) is not used.

You can configure the SBC function to be activated before, at the same time with, or after the drive STO function. When you use an encoder, you can also configure the SBC function to be activated at a user-defined speed limit.

With emergency ramp

The behavior of the SSE with emergency ramp is identical to the SS1 function (see section [Safe stop 1 \(SS1\)](#) on page 80) except that different time and ramp monitoring parameters are used. The SSE function uses SAR0 parameters to monitor and/or define the emergency ramp. Drive ramp parameters cannot be used.

When you use the SBC function with the SSE function, you can configure the SBC and drive STO combination to be activated at a user-defined speed limit while ramping down to zero speed. You can also define a delay so that the SBC is activated first at the user-defined speed limit and the drive STO after the delay.

This section describes the different versions of the SSE function separately without and with an encoder.

Note: Always set the parameters related to the SSE function to have the correct trip limit hit and fault reaction behavior. An internal monitoring of the FSO module can trigger the SSE function even if you have not defined an external request signal. These internal monitorings trigger SSE:

- SMS or SLS function speed limit hits
 - SDI safety function position limit hit
 - PROFIsafe fault
 - FSO module I/O fault, FSO module overtemperature, FSO module power supply fault.
-

■ SSE with immediate STO

The operation of the SSE with immediate STO function is described in the time diagrams and tables below. For configuration, see section [How to configure SSE with immediate STO](#) on page 353.

Without an encoder

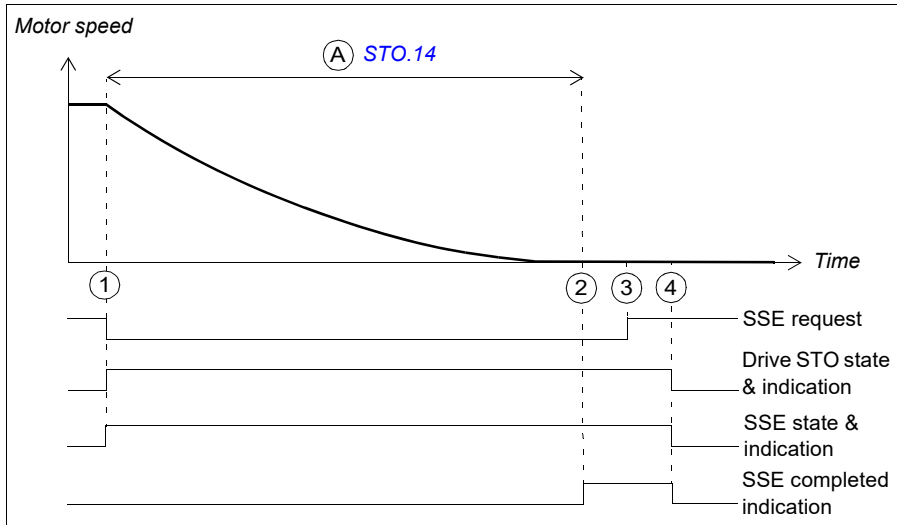

- A Time to zero speed (parameter [STO.14](#)): Time from the STO activation to the moment when the safety function is completed, the SSE completed indication (parameter [SSE.22](#)) goes on and the acknowledgment becomes allowed. You must set this to the estimated time in which the motor coasts to a stop from the maximum speed.

Step	Description
1	The SSE request is received (for example, from the I/O). The FSO activates the drive STO function and starts a counter for time A. SSE active indication SSE output (SSE.21) and STO output (STO.21) go on.
2	After time A has elapsed, the FSO module defines the motor as stopped and the SSE completed indication goes on. The acknowledgement becomes allowed as soon as the SSE request has been removed (step 3).
3	The SSE request is removed.
4	After the acknowledgement, the SSE and STO functions are deactivated, and the control is given back to the drive. The indications SSE output (SSE.21) , SSE completed output (SSE.22) , and STO output (STO.21) go off.

With an encoder

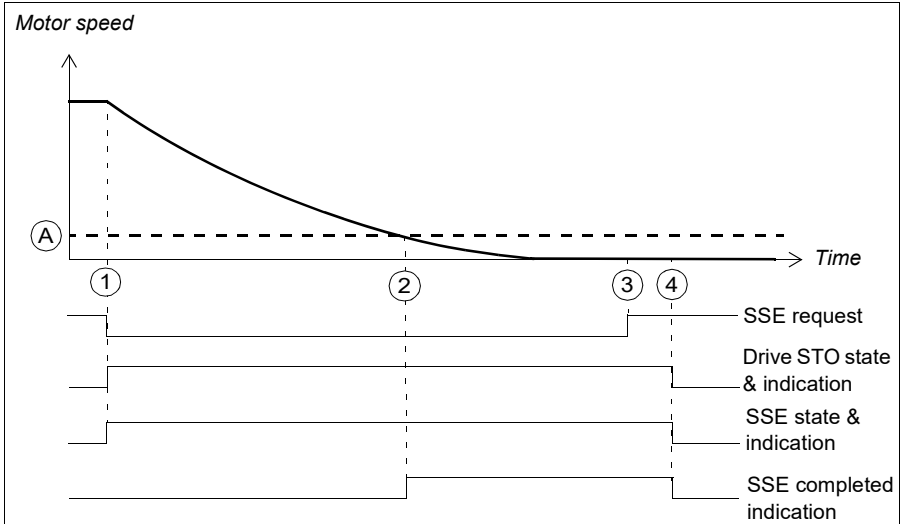

- A Zero speed with encoder (parameter *FSOGEN.52*): Speed limit at which the motor has stopped, the safety function is completed and the SSE completed indication (parameter *SSE.22*) goes on. The acknowledgement becomes allowed.

Step	Description
1	The SSE request is received (for example, from the I/O). The FSO activates the drive STO function. SSE active indication <i>SSE output (SSE.21)</i> and <i>STO output (STO.21)</i> go on.
2	The motor speed reaches the zero speed limit (A), the FSO defines the motor as stopped and the SSE completed indication goes on. The acknowledgement becomes allowed as soon as the SSE request has been removed (step 3).
3	The SSE request is removed.
4	After the acknowledgement, the SSE and STO functions are deactivated, and the control is given back to the drive. The indications <i>SSE output (SSE.21)</i> , <i>SSE completed output (SSE.22)</i> , and <i>STO output (STO.21)</i> go off.

■ SSE with immediate STO, SBC after STO

The operation of the SSE with immediate STO, SBC after STO (positive SBC delay) is described in the time diagrams and tables below. For configuration, see section [How to configure SSE with immediate STO, SBC after or before STO](#) on page 355.

Without an encoder

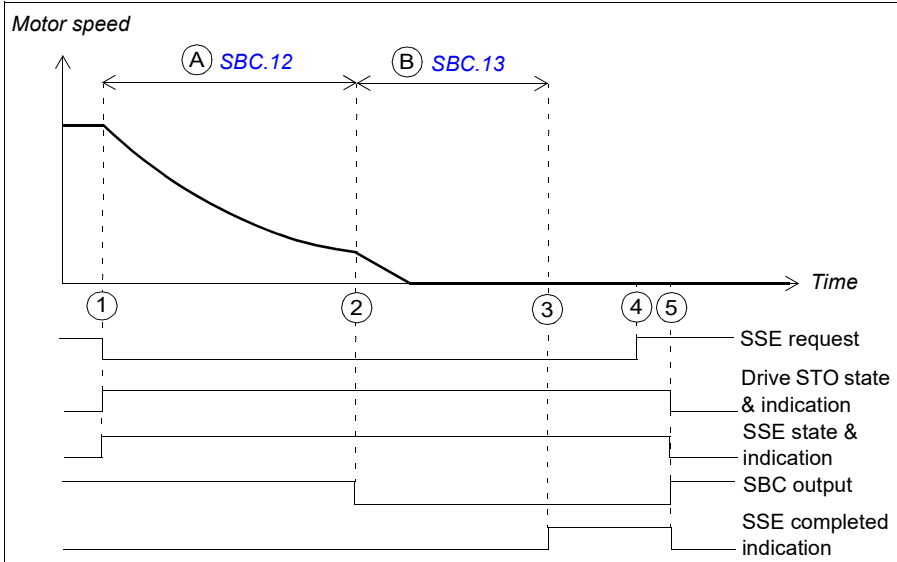

- A SBC delay (parameter [SBC.12](#)): Time from the activation of the drive STO function to the moment when the FSO activates the SBC function (brake). In this case, the value is positive and the FSO activates the SBC after the drive STO. If the value is zero, the FSO activates the SBC and drive STO functions at the same time. **Note:** It is possible to set the SBC delay so that the SBC is activated while the motor is still rotating.
- B SBC time to zero speed (parameter [SBC.13](#)): Time from the SBC activation to the moment when the safety function is completed and the SSE completed indication (parameter [SSE.22](#)) goes on. The acknowledgment becomes allowed. You must set this to the estimated time in which the motor brakes to a stop from the maximum speed.

Step	Description
1	The SSE request is received (for example, from the I/O). The FSO activates the drive STO function and starts a counter for time A. SSE active indication <i>SSE output (SSE.21)</i> and <i>STO output (STO.21)</i> go on.
2	After time A has elapsed, the FSO activates the SBC and starts a counter for time B.
3	After time B has elapsed, the FSO module defines the motor as stopped and the SSE completed indication goes on. The acknowledgement becomes allowed as soon as the SSE request has been removed (step 4).
4	The SSE request is removed.
5	After the acknowledgement, the SSE, STO and SBC functions are deactivated and the control is given back to the drive, which controls the brake from now on. The indications <i>SSE output (SSE.21)</i> , <i>SSE completed output (SSE.22)</i> , and <i>STO output (STO.21)</i> go off.

With an encoder

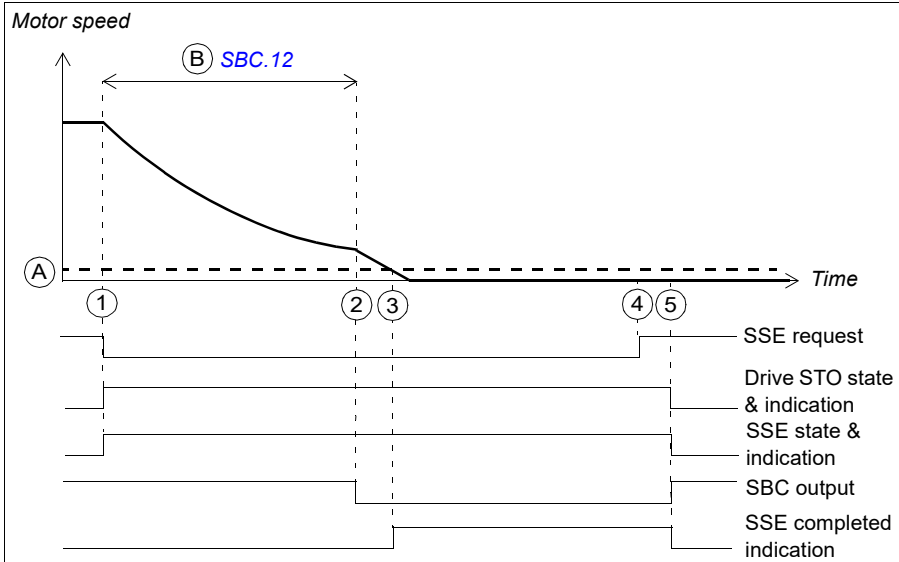

- A Zero speed with encoder (parameter *FSOGEN.52*): Speed limit at which the motor has stopped, the SSE completed indication (parameter *SSE.22*) goes on and the acknowledgment becomes allowed.
- B SBC delay (parameter *SBC.12*): Time from the activation of the drive STO function to the moment when the FSO activates the SBC function (brake). In this case, the value is positive and the FSO activates the SBC after the drive STO. If the value is zero, the FSO activates the SBC and drive STO at the same time. **Note:** It is possible to set the SBC delay so that the SBC is activated while the motor is still rotating.

Step	Description
1	SSE request is received (for example, from the I/O). The FSO activates the drive STO and starts a counter for time B. SSE active indication <i>SSE output (SSE.21)</i> and <i>STO output (STO.21)</i> go on.
2	After time B has elapsed, the FSO activates the SBC function (brake). Note: If speed limit A is reached before time B has elapsed, the FSO activates the SBC immediately when the motor has stopped.
3	The motor speed reaches the zero speed limit (A), the FSO module defines the motor as stopped and the SSE completed indication goes on. The acknowledgement becomes allowed as soon as the SSE request has been removed (step 4).
4	The SSE request is removed.
5	After the acknowledgement, the SSE, STO and SBC functions are deactivated and the control is given back to the drive, which controls the brake from now on. The indications <i>SSE output (SSE.21)</i> , <i>SSE completed output (SSE.22)</i> , and <i>STO output (STO.21)</i> go off.

■ SSE with immediate STO, SBC before STO

The operation of the SSE with immediate STO, SBC before the STO (negative SBC delay) is described in the time diagrams and tables below. For configuration, see section [How to configure SSE with immediate STO, SBC after or before STO](#) on page 355.

The reason to use a negative SBC delay is to have the mechanical brake closed just before the drive STO circuit is opened.

Without an encoder

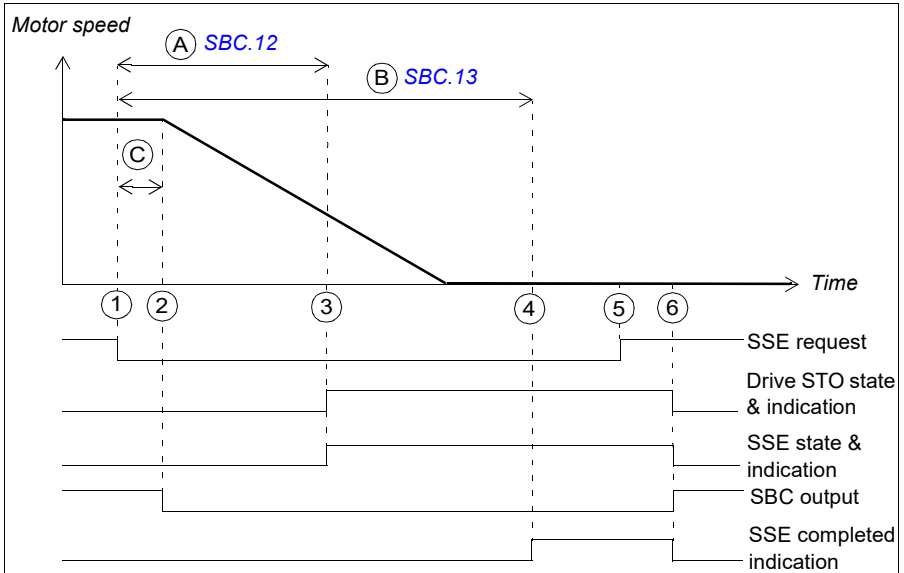

- A SBC delay (parameter [SBC.12](#)): Time from the activation of the drive STO function to the moment when the FSO activates the SBC function (brake). In this case, the value is negative and the FSO activates the SBC before the drive STO. If the value is zero, the FSO activates the SBC and drive STO functions at the same time.
- B SBC time to zero speed (parameter [SBC.13](#)): Time from the SBC activation to the moment when the safety function is completed and the SSE completed indication (parameter [SSE.22](#)) goes on. The acknowledgment becomes allowed. You must set this to the estimated time in which the motor brakes to a stop from the maximum speed.
- C Response time (depends on system configuration, see page 532)

Step	Description
1	The SSE request is received (for example, from the I/O). The FSO activates the SBC function (brake) and starts counters for times A and B. SSE active indication <i>SSE output (SSE.21)</i> and <i>STO output (STO.21)</i> go on.
2	After time C has elapsed, the SBC starts to brake the motor.
3	After time A has elapsed, the FSO activates the drive STO function.
4	After time B has elapsed, the FSO module defines the motor as stopped and the SSE completed indication goes on. The acknowledgement becomes allowed as soon as the SSE request has been removed (step 5).
5	The SSE request is removed.
6	After the acknowledgement, the SSE, STO and SBC functions are deactivated and the control is given back to the drive, which controls the brake from now on. The indications <i>SSE output (SSE.21)</i> , <i>SSE completed output (SSE.22)</i> , and <i>STO output (STO.21)</i> go off.

With an encoder

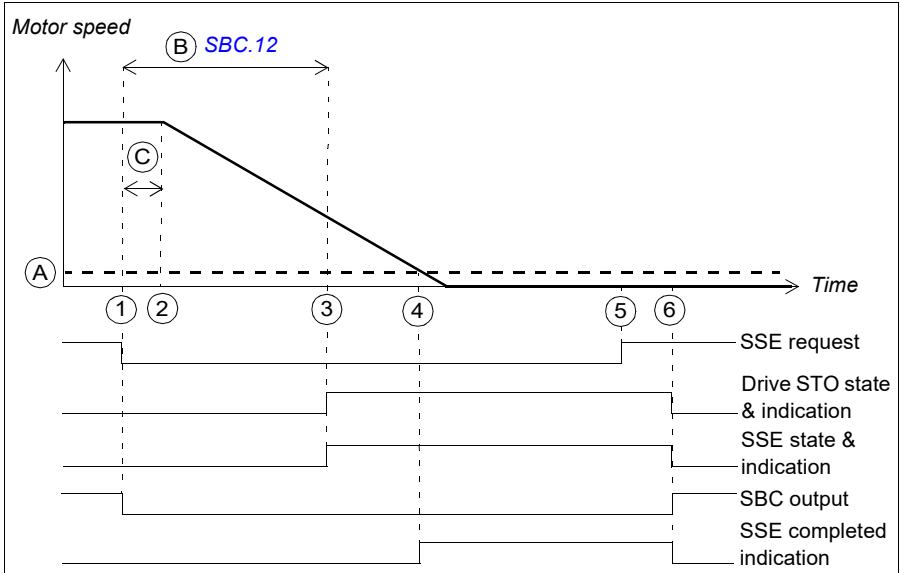

- A Zero speed with encoder (parameter [FSOGEN.52](#)): Speed limit at which the motor has stopped, the safety function is completed and the SSE completed indication (parameter [SSE.22](#)) goes on. The acknowledgement becomes allowed.
- B SBC delay (parameter [SBC.12](#)): Time from the activation of the drive STO function to the moment when the FSO activates the SBC function (brake). In this case, the value is negative and the FSO activates the SBC before the drive STO. If the value is zero, the FSO activates the SBC and drive STO functions at the same time.
- C Response time (depends on system configuration, see page [532](#))

Step	Description
1	The SSE request is received (for example, from the I/O). The FSO activates the SBC and starts a counter for time B. SSE active indication SSE output (SSE.21) and STO output (STO.21) go on.
2	After time C has elapsed, the SBC starts to brake the motor.
3	After time B has elapsed, the FSO activates the drive STO function.
4	The motor speed reaches the zero speed limit (A), the FSO module defines the motor as stopped and the SSE completed indication goes on. The acknowledgement becomes allowed as soon as the SSE request has been removed (step 5).
5	The SSE request is removed.
6	After the acknowledgement, the SSE, STO and SBC functions are deactivated, and the control is given back to the drive, which controls the brake from now on. The indications SSE output (SSE.21) , SSE completed output (SSE.22) , and STO output (STO.21) go off.

SSE with immediate STO, with speed limit activated SBC

This safety function requires that you use an encoder in the safety application.

The operation of the SSE with immediate STO with speed limit activated SBC is described in the time diagram and table below. For configuration, see section [How to configure STO with speed limit activated SBC](#) on page 339.

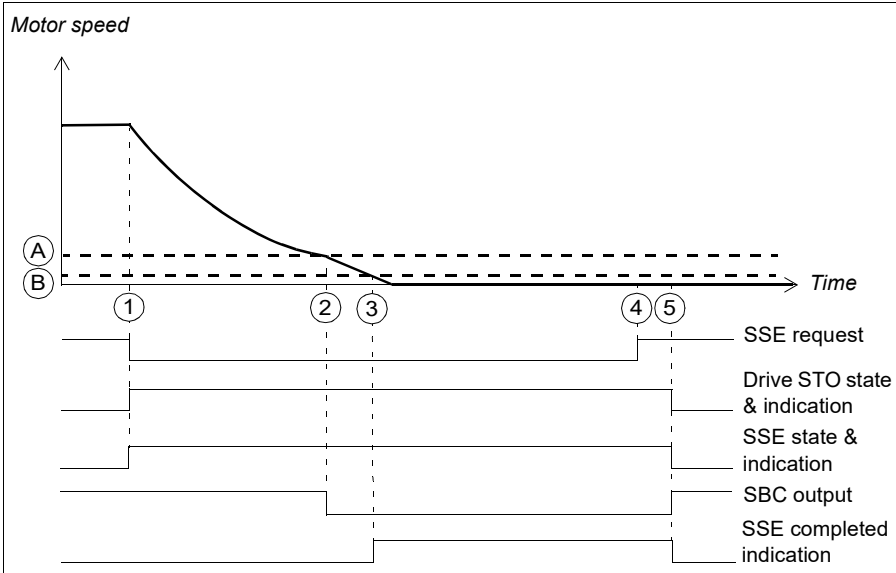

- A STO SBC speed (parameter [SBC.14](#)): Speed limit at which the FSO activates the SBC function (brake).
- B Zero speed with encoder (parameter [FSOGEN.52](#)): Speed limit at which the motor has stopped, the safety function is completed and the SSE completed indication (parameter [SSE.22](#)) goes on. The acknowledgement becomes allowed.

Step	Description
1	The SSE request is received (for example, from the I/O). The FSO activates the drive STO function. SSE active indication SSE output (SSE.21) and STO output (STO.21) go on.
2	The motor speed goes below the SBC speed limit (A) and the FSO activates the SBC function (brake).
3	The motor speed reaches the zero speed limit (B), the FSO module defines the motor as stopped and the SSE completed indication goes on. The acknowledgement becomes allowed as soon as the SSE request has been removed (step 4).
4	The SSE request is removed.
5	After the acknowledgement, the STO, SSE and SBC functions are deactivated and the control is given back to the drive, which controls the brake from now on. The indications SSE output (SSE.21) , SSE completed output (SSE.22) , and STO output (STO.21) go off.

SSE with time monitoring

The operation of the SSE with time monitoring is described in the time diagrams and tables below. For configuration, see section [How to configure SSE with time monitoring](#) on page 356.

With a safe speed estimate

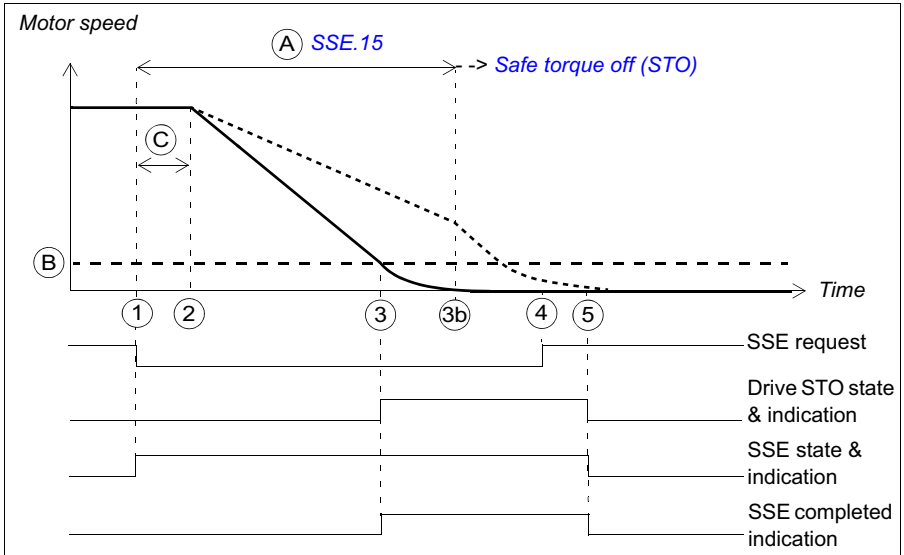

- A SSE delay for STO (parameter [SSE.15](#)): Time after which the FSO activates the STO function regardless of the motor speed.
- B Zero speed (parameter [FSOGEN.51](#)): Speed limit for activating the drive STO function. The safety function is completed and the SSE completed indication (parameter [SSE.22](#)) goes on. The acknowledgment becomes allowed.
- C Response time (depends on system configuration, see page 532)

Step	Description
1	The SSE request is received (for example, from the I/O). The FSO starts a counter for time A. SSE active indication <i>SSE output (SSE.21)</i> goes on.
2	After time C has elapsed, the drive starts to ramp down the motor speed. SAR0 parameter <i>200.102</i> defines the deceleration ramp.
3	<p>The motor speed reaches the zero speed limit (B), FSO activates the drive STO function and STO active indication parameter <i>STO output (STO.21)</i> goes on. The SSE completed indication goes on and the acknowledgement becomes allowed as soon as the SSE request has been removed (step 4).</p> <p>Note: If the SBC is configured in the STO function (see section <i>Safe torque off (STO)</i> on page 68), also the SBC is activated (not shown in the figure).</p> <ul style="list-style-type: none"> • If the <i>STO SBC delay</i> (parameter <i>SBC.12</i>) is negative, the SBC is activated here and the drive STO after this delay. • If the <i>STO SBC delay</i> is positive or zero, the SBC and drive STO functions are activated at the same time. • The SSE completed indication goes on after the delay defined with parameter <i>SBC.13</i> has elapsed from the SBC activation. <p>Note: You can define an extra delay (parameter <i>SSE.16</i>) before the FSO activates the drive STO (and SBC, if used) (not shown in the figure).</p>
3b	If the drive has not ramped down fast enough when time A has elapsed, the FSO activates the STO function. See section <i>Safe torque off (STO)</i> on page 68 for more information on how to configure the STO function.
4	The SSE request is removed.
5	After the acknowledgement, the STO and SSE functions are deactivated. The indications <i>SSE output (SSE.21)</i> , <i>SSE completed output (SSE.22)</i> , and <i>STO output (STO.21)</i> go off.

With an encoder

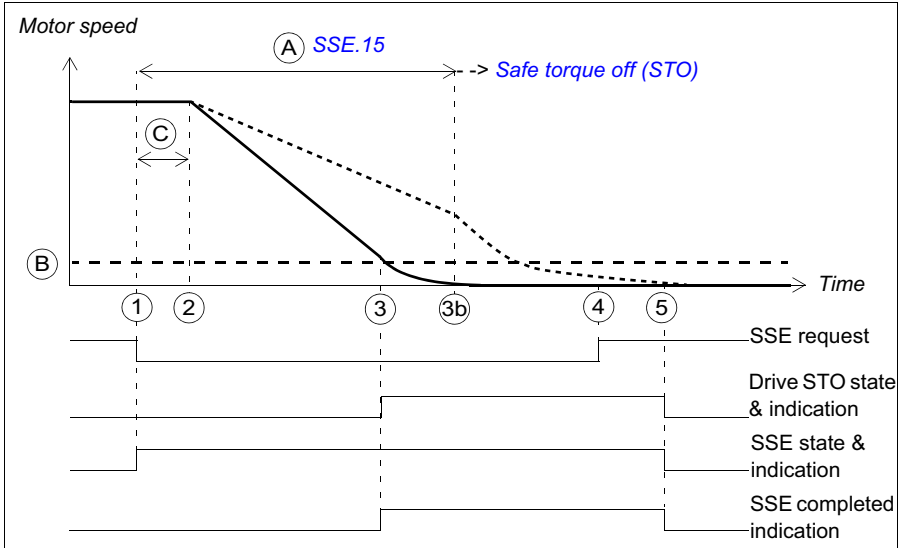

- A SSE delay for STO (parameter [SSE.15](#)): Time after which the FSO activates the STO function regardless of the motor speed.
- B Zero speed with encoder (parameter [FSOGEN.52](#)): Speed limit for activating the drive STO function. The safety function is completed and the SSE completed indication (parameter [SSE.22](#)) goes on. The acknowledgment becomes allowed.
- C Response time (depends on system configuration, see page [532](#))

Step	Description
1	The SSE request is received (for example, from the I/O). The FSO starts a counter for time A. SSE active indication <i>SSE output (SSE.21)</i> goes on.
2	After time C has elapsed, the drive starts to ramp down the motor speed. SAR0 parameter <i>200.102</i> defines the deceleration ramp.
3	<p>The motor speed reaches the zero speed limit (B), the FSO activates the drive STO function and STO active indication parameter <i>STO output (STO.21)</i> goes on. The SSE completed indication goes on and the acknowledgement becomes allowed as soon as the SSE request has been removed (step 4).</p> <p>Note: If the SBC is configured in the STO function (see section <i>Safe torque off (STO)</i> on page 68), also the SBC is activated (not shown in the figure).</p> <ul style="list-style-type: none"> • If the <i>STO SBC delay</i> (parameter <i>SBC.12</i>) is negative, the SBC is activated here and the drive STO after this delay. • If the <i>STO SBC delay</i> is positive or zero, the SBC and drive STO functions are activated at the same time. <p>Note: You can define an extra delay (parameter <i>SSE.16</i>) before the FSO activates the drive STO (and SBC, if used) (not shown in the figure).</p>
3b	If the drive has not ramped down fast enough when time A has elapsed, the FSO activates the STO function. See section <i>Safe torque off (STO)</i> on page 68 for more information on how to configure the STO function.
4	The SSE request is removed.
5	After the acknowledgement, the STO and SSE functions are deactivated. The indications <i>SSE output (SSE.21)</i> , <i>SSE completed output (SSE.22)</i> , and <i>STO output (STO.21)</i> go off.

SSE with ramp monitoring

The operation of the SSE with ramp monitoring is described in the time diagrams and tables below. For configuration, see section [How to configure SSE with ramp monitoring](#) on page 357.

With a safe speed estimate

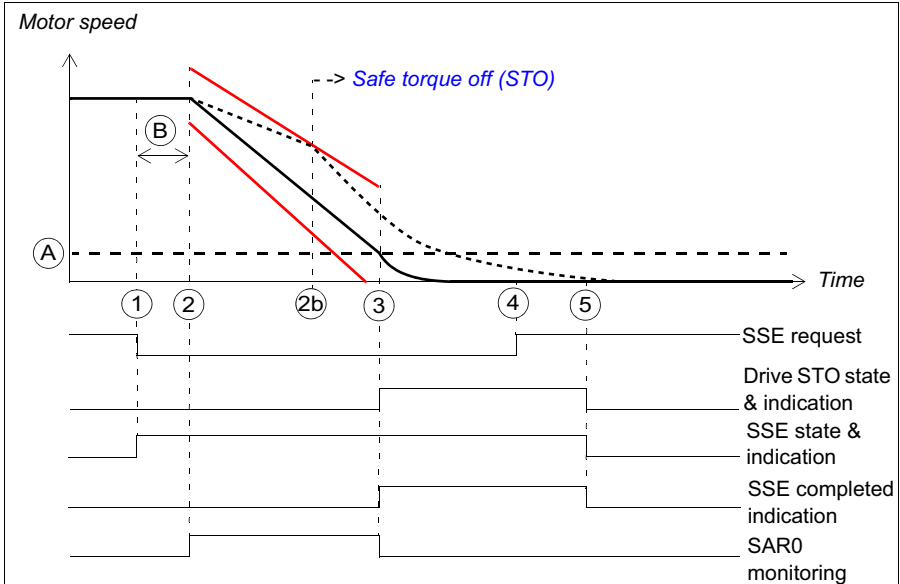

- A Zero speed (parameter [FSOGEN.51](#)): Speed limit for activating the drive STO function. The safety function is completed, ramp monitoring is stopped and the SSE completed indication (parameter [SSE.22](#)) goes on. The acknowledgment becomes allowed.
- B Response time (depends on system configuration, see page 532)
- Ramp monitoring limits

Step	Description
1	The SSE request is received (for example, from the I/O). SSE active indication <i>SSE output (SSE.21)</i> goes on.
2	After time C has elapsed, the drive starts to ramp down the motor speed. SAR0 parameter <i>200.102</i> defines the deceleration ramp. The FSO starts the SAR0 ramp monitoring (parameters <i>SARx.11</i> and <i>SARx.12</i>).
2b	If the motor speed hits a ramp monitoring limit, the FSO activates the STO function. See section <i>Safe torque off (STO)</i> on page 68 for more information on how to configure the STO function.
3	<p>The motor speed reaches the zero speed limit (B), the FSO stops the SAR0 monitoring and activates the drive STO function, and STO active indication parameter <i>STO output (STO.21)</i> goes on. The SSE completed indication goes on the acknowledgement becomes allowed as soon as the SSE request has been removed (step 4).</p> <p>Note: If the SBC is configured in the STO function (see section <i>Safe torque off (STO)</i> on page 68), also the SBC is activated (not shown in the figure).</p> <ul style="list-style-type: none"> • If the <i>STO SBC delay</i> (parameter <i>SBC.12</i>) is negative, the SBC is activated here and the drive STO after this delay. • If the <i>STO SBC delay</i> is positive or zero, the SBC and drive STO functions are activated at the same time. <p>The SSE completed indication goes on after the delay defined with parameter <i>SBC.13</i> has elapsed from the SBC activation.</p> <p>Note: You can define an extra delay (parameter <i>SSE.16</i>) before the FSO activates the drive STO (and SBC, if used) (not shown in the figure).</p>
4	The SSE request is removed.
5	After the acknowledgement, the STO and SSE functions are deactivated and the control is given back to the drive, which can modulate again. The indications <i>SSE output (SSE.21)</i> , <i>SSE completed output (SSE.22)</i> , and <i>STO output (STO.21)</i> go off.

With an encoder

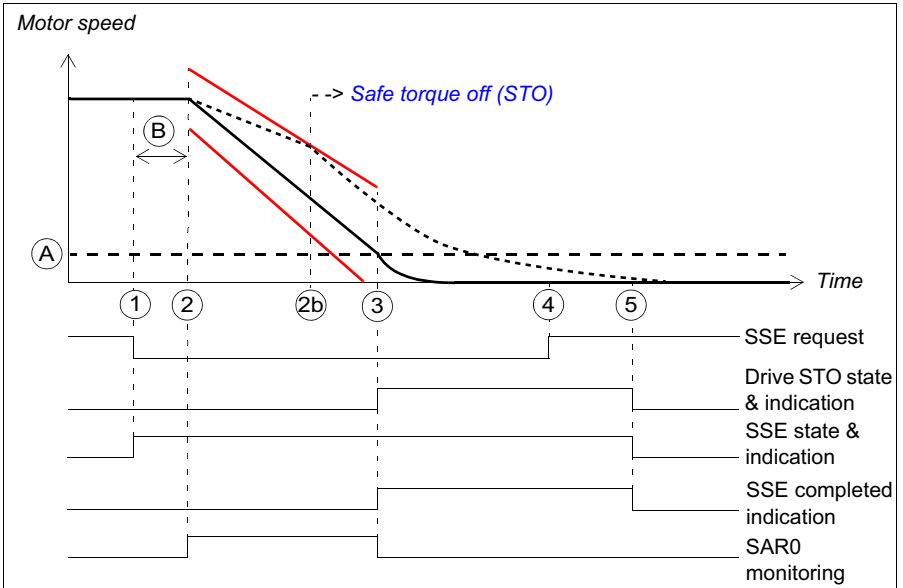

- A Zero speed with encoder (parameter [FSOGEN.52](#)): Speed limit for activating the drive STO function. The safety function is completed, ramp monitoring is stopped and the SSE completed indication (parameter [SSE.22](#)) goes on. The acknowledgment becomes allowed.
- B Response time (depends on system configuration, see page [532](#))
- Ramp monitoring limits

Step	Description
1	The SSE request is received (for example, from the I/O). SSE active indication <i>SSE output (SSE.21)</i> goes on.
2	After time B has elapsed, the drive starts to ramp down the motor speed. SAR0 parameter <i>200.102</i> defines the deceleration ramp. The FSO starts the SAR0 ramp monitoring (parameters <i>SARx.11</i> and <i>SARx.12</i>).
2b	If the motor speed hits a ramp monitoring limit, the FSO activates the STO function. See section <i>Safe torque off (STO)</i> on page 68 for more information on how to configure the STO function.
3	<p>The motor speed reaches the zero speed limit (A), the FSO stops the SAR0 monitoring and activates the drive STO function, and STO active indication parameter <i>STO output (STO.21)</i> goes on. The SSE completed indication goes on and the acknowledgement becomes allowed as soon as the SSE request has been removed (step 4).</p> <p>Note: If the SBC is configured in the STO function (see section <i>Safe torque off (STO)</i> on page 68), also the SBC is activated (not shown in the figure).</p> <ul style="list-style-type: none"> • If the <i>STO SBC delay</i> (parameter <i>SBC.12</i>) is negative, the SBC is activated here and the drive STO after this delay. <p>If the <i>STO SBC delay</i> is positive or zero, the SBC and drive STO functions are activated at the same time.</p> <p>Note: You can define an extra delay (parameter <i>SSE.16</i>) before the FSO activates the drive (and SBC, if used) (not shown in the figure).</p>
4	The SSE request is removed.
5	After the acknowledgement, the STO and SSE functions are deactivated and the control is given back to the drive, which is allowed to modulate again. The indications <i>SSE output (SSE.21)</i> , <i>SSE completed output (SSE.22)</i> , and <i>STO output (STO.21)</i> go off.

■ SSE with speed limit activated SBC

In these examples, the SBC and drive STO functions are activated at a user-defined speed limit.

With time monitoring

The operation of the SSE with speed limit activated SBC and time monitoring is described in the time diagrams and tables below. For configuration, see section [How to configure SSE with speed limit activated SBC](#) on page 358.

With a safe speed estimate

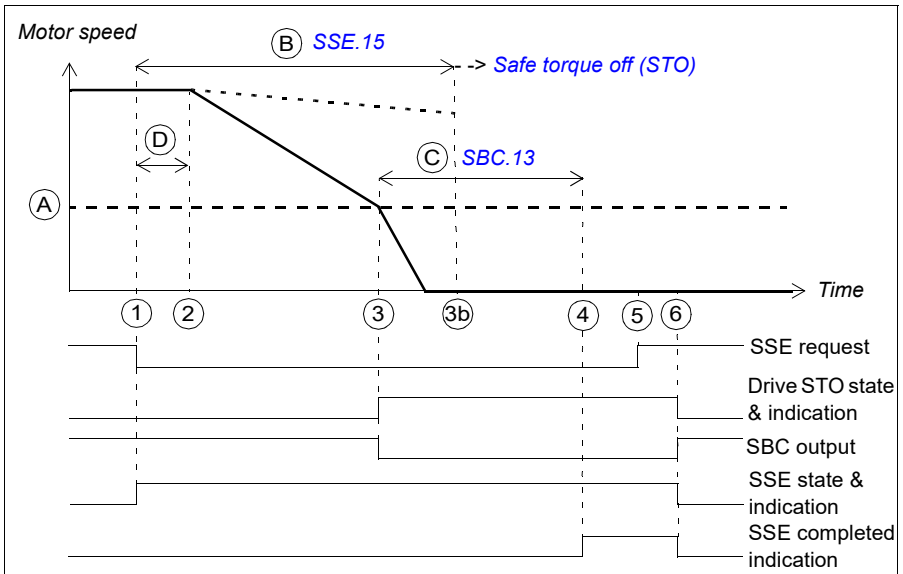

- A SBC speed (parameter [SBC.15](#)): Speed limit below which the FSO activates SBC (brake) and drive STO functions while ramping.
- B SSE delay for STO (parameter [SSE.15](#)): Time after which the FSO activates the drive STO function regardless of the motor speed.
- C SBC time to zero (parameter [SBC.13](#)): Time from the SBC activation to the moment when the safety function is completed and the SSE completed indication (parameter [SSE.22](#)) goes on. The acknowledgment becomes allowed. You must set this to the estimated time in which the motor brakes to a stop from the maximum speed.
- D Response time (depends on system configuration, see page 532)

Step	Description
1	The SSE request is received (for example, from the I/O). The FSO starts a counter for time B. SSE active indication <i>SSE output (SSE.21)</i> goes on.
2	After time D has elapsed, the drive starts to ramp down the motor speed. SAR0 parameter <i>200.102</i> defines the deceleration ramp.
3	<p>The motor speed goes below the SBC speed limit (A), the FSO checks the value of <i>STO SBC delay</i> (parameter <i>SBC.12</i>) and activates the SBC and drive STO functions:</p> <ul style="list-style-type: none"> • If the <i>STO SBC delay</i> is positive or zero, the SBC and drive STO functions are activated at the same time (this case is shown in the figure). • If the <i>STO SBC delay</i> is negative, the SBC is activated here and the drive STO after this delay (see section <i>SSE with speed limit activated SBC, SBC before STO</i> on page 133). • STO active indication parameter <i>STO output (STO.21)</i> goes on when STO is activated. <p>The FSO starts a counter for time C.</p> <p>Note: You can define an extra delay (parameter <i>SSE.16</i>) before the FSO activates the SBC and drive STO functions (not shown in the figure).</p>
3b	If the drive has not ramped down fast enough when time B has elapsed, the FSO activates the STO function. See section <i>Safe torque off (STO)</i> on page 68 for more information on how to configure the STO function.
4	After time C has elapsed, the FSO defines the motor as stopped, the SSE completed indication goes on and the acknowledgement becomes allowed as soon as the SSE request has been removed (step 5).
5	The SSE request is removed.
6	After the acknowledgement, the SSE, STO and SBC functions are deactivated and the control is given back to the drive, which is allowed to modulate again. The indications <i>SSE output (SSE.21)</i> , <i>SSE completed output (SSE.22)</i> , and <i>STO output (STO.21)</i> go off.

With an encoder

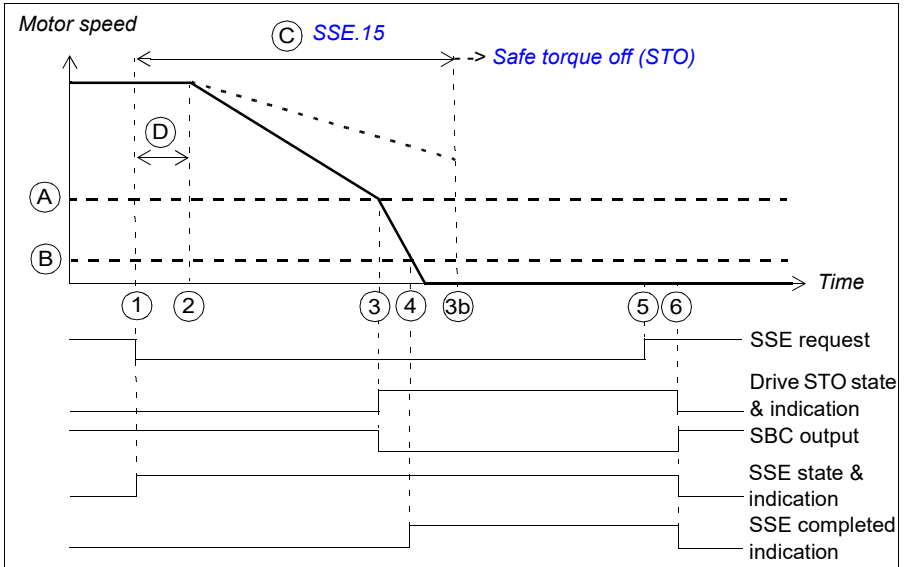

- A SBC speed (parameter [SBC.15](#)): Speed limit below which the FSO activates the SBC (brake) and drive STO functions while ramping.
- B Zero speed with encoder (parameter [FSOGEN.52](#)): Speed limit to define the motor as stopped. The safety function is completed and the SSE completed indication (parameter [SSE.22](#)) goes on. The acknowledgment becomes allowed.
- C SSE delay for STO (parameter [SSE.15](#)): Time after which the FSO activates the STO function regardless of the motor speed.
- D Response time (depends on system configuration, see page [532](#))

Step	Description
1	The SSE request is received (for example, from the I/O). The FSO starts a counter for time C. SSE active indication <i>SSE output (SSE.21)</i> goes on.
2	After time D has elapsed, the drive starts to ramp down the motor speed. SAR0 parameter <i>200.102</i> defines the deceleration ramp.
3	<p>The motor speed goes below the SBC speed limit (A), the FSO checks the value of <i>STO SBC delay</i> (parameter <i>SBC.12</i>) and activates the SBC and drive STO functions:.</p> <ul style="list-style-type: none"> • If the <i>STO SBC delay</i> is positive or zero, the SBC and drive STO functions are activated at the same time (this case is shown in the figure). • If the <i>STO SBC delay</i> is negative, the SBC is activated here and the drive STO after this delay (see section <i>SSE with speed limit activated SBC, SBC before STO</i> on page <i>133</i>). • STO active indication parameter <i>STO output (STO.21)</i> goes on when STO is activated. <p>Note: You can define an extra delay (parameter <i>SSE.16</i>) before the FSO activates the SBC and drive STO functions (not shown in the figure).</p>
3b	If the drive has not ramped down fast enough when time C has elapsed, the FSO activates the STO function. See section <i>Safe torque off (STO)</i> on page <i>68</i> for more information on how to configure the STO function.
4	The motor speed reaches the zero speed limit (B), the FSO defines the motor as stopped, the SSE completed indication goes on and the acknowledgement becomes allowed as soon as the SSE request has been removed (step 5).
5	The SSE request is removed.
6	After the acknowledgement, the SSE, STO and SBC functions are deactivated and the control is given back to the drive, which is allowed to modulate again. The indications <i>SSE output (SSE.21)</i> , <i>SSE completed output (SSE.22)</i> , and <i>STO output (STO.21)</i> go off.

With ramp monitoring

The operation of the SSE with speed limit activated SBC and ramp monitoring is described in the time diagrams and tables below. For configuration, see section [How to configure SSE with speed limit activated SBC](#) on page 358.

With a safe speed estimate

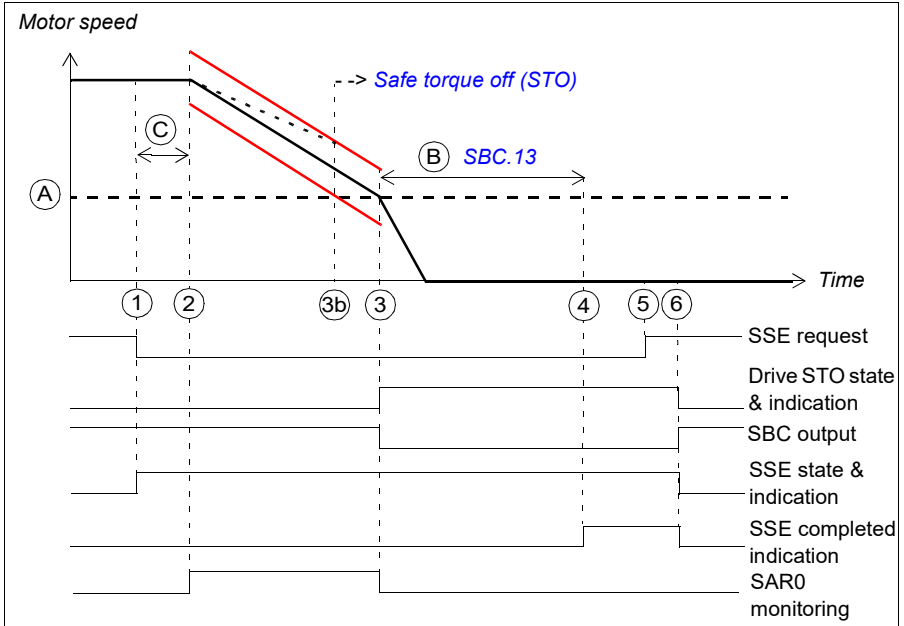

- A SBC speed (parameter [SBC.15](#)): Speed limit below which the FSO activates the SBC (brake) and drive STO functions while ramping. The safety function is completed, the ramp monitoring is stopped and the SSE completed indication (parameter [SSE.22](#)) goes on. The acknowledgment becomes allowed.
- B SBC time to zero (parameter [SBC.13](#)): Time from the SBC activation to the moment when the safety function is completed and the SSE completed indication (parameter [SSE.22](#)) goes on. The acknowledgment becomes allowed. You must set this to the estimated time in which the motor brakes to a stop from the maximum speed.
- C Response time (depends on system configuration, see page [532](#))
- Ramp monitoring limits

Step	Description
1	The SSE request is received (for example, from the I/O). SSE active indication <i>SSE output (SSE.21)</i> goes on.
2	After time C has elapsed, the drive starts to ramp down the motor speed. SAR0 parameter <i>200.102</i> defines the deceleration ramp. The FSO starts the SAR0 ramp monitoring (parameters <i>SARx.11</i> and <i>SARx.12</i>).
3	<p>The motor speed goes below the SBC speed limit (A), the FSO stops the SAR1 monitoring. The FSO checks the value of <i>STO SBC delay</i> (parameter <i>SBC.12</i>) and activates the SBC and drive STO functions:</p> <ul style="list-style-type: none"> • If the <i>STO SBC delay</i> is positive or zero, the SBC and drive STO functions are activated at the same time (this case is shown in the figure). • If the <i>STO SBC delay</i> is negative, the SBC is activated here and the drive STO after this delay (see section <i>SSE with speed limit activated SBC, SBC before STO</i> on page 133.) • STO active indication parameter <i>STO output (STO.21)</i> goes on when STO is activated. <p>The FSO starts a counter for time B.</p> <p>Note: You can define an extra delay (parameter <i>SSE.16</i>) before the FSO activates the SBC and drive STO functions (not shown in the figure).</p>
3b	If the motor speed hits a ramp monitoring limit, the FSO activates the STO function. See section <i>Safe torque off (STO)</i> on page 68 for more information on how to configure the STO function.
4	After time B has elapsed, the FSO defines the motor as stopped, the SSE completed indication goes on and the acknowledgement becomes allowed as soon as the SSE request has been removed (step 5).
5	The SSE request is removed.
6	After the acknowledgement, the SSE, STO and SBC functions are deactivated and the control is given back to the drive, which is allowed to modulate again. The indications <i>SSE output (SSE.21)</i> , <i>SSE completed output (SSE.22)</i> , and <i>STO output (STO.21)</i> go off.

With an encoder

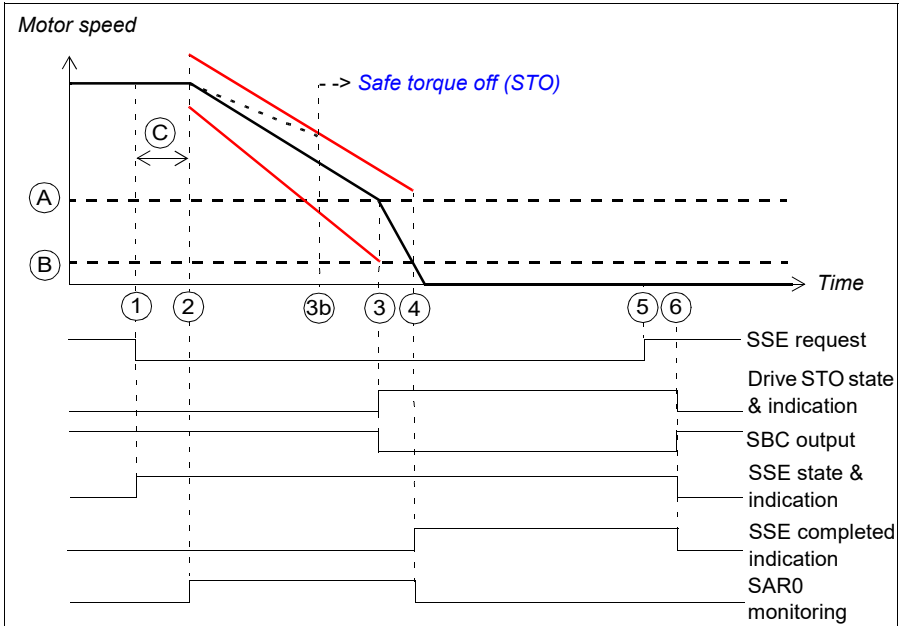

- A SBC speed (parameter [SBC.15](#)): Speed limit below which FSO activates the SBC (brake) and drive STO functions while ramping and stops the ramp monitoring.
 - B Zero speed with encoder (parameter [FSOGEN.52](#)): Speed limit to define the motor as stopped. The safety function is completed, the ramp monitoring is stopped and the SSE completed indication (parameter [SSE.22](#)) goes on. The acknowledgment becomes allowed.
 - C Response time (depends on system configuration, see page [532](#))
- Ramp monitoring limits

Step	Description
1	The SSE request is received (for example, from the I/O). SSE active indication <i>SSE output (SSE.21)</i> goes on.
2	After time C has elapsed, the drive starts to ramp down the motor speed. SAR0 parameter <i>200.102</i> defines the deceleration ramp. The FSO starts the SAR0 ramp monitoring (parameters <i>SARx.11</i> and <i>SARx.12</i>).
3	<p>The motor speed goes below the SBC speed limit (A). The FSO checks the value of <i>STO SBC delay</i> (parameter <i>SBC.12</i>) and activates the SBC and drive STO functions:</p> <ul style="list-style-type: none"> • If the <i>STO SBC delay</i> is positive or zero, the SBC and drive STO functions are activated at the same time (this case is shown in the figure). • If the <i>STO SBC delay</i> is negative, the SBC is activated here and the drive STO after this delay (see section <i>SSE with speed limit activated SBC, SBC before STO</i> on page 133). • STO active indication parameter <i>STO output (STO.21)</i> goes on when STO is activated. <p>Note: You can define an extra delay (parameter <i>SSE.16</i>) before the FSO activates the SBC and drive STO functions (not shown in the figure).</p>
3b	If the motor speed hits a ramp monitoring limit, the FSO activates the STO function. See section <i>Safe torque off (STO)</i> on page 68 for more information on how to configure the STO function.
4	The motor speed reaches the zero speed limit (B), the FSO defines the motor as stopped and the SSE completed indication goes on. The acknowledgement becomes allowed as soon as the SSE request has been removed (step 5). The FSO stops the SAR0 monitoring.
5	The SSE request is removed.
6	After the acknowledgement, the SSE, STO and SBC functions are deactivated and the control is given back to the drive, which is allowed to modulate again. The indications <i>SSE output (SSE.21)</i> , <i>SSE completed output (SSE.22)</i> , and <i>STO output (STO.21)</i> go off.

■ SSE with speed limit activated SBC, SBC before STO

In these examples, the SBC function is activated at a user-defined speed limit and drive STO function after a user-defined delay (negative SBC delay). The reason to use a negative SBC delay (parameter [SBC.12](#)) is to have the mechanical brake closed just before the drive STO circuit is opened.

With time monitoring

The operation of the SSE with speed limit activated SBC, SBC before STO and time monitoring is described in the time diagrams and tables below. For configuration, see section [How to configure SSE with speed limit activated SBC, SBC before STO](#) on page [362](#).

With a safe speed estimate

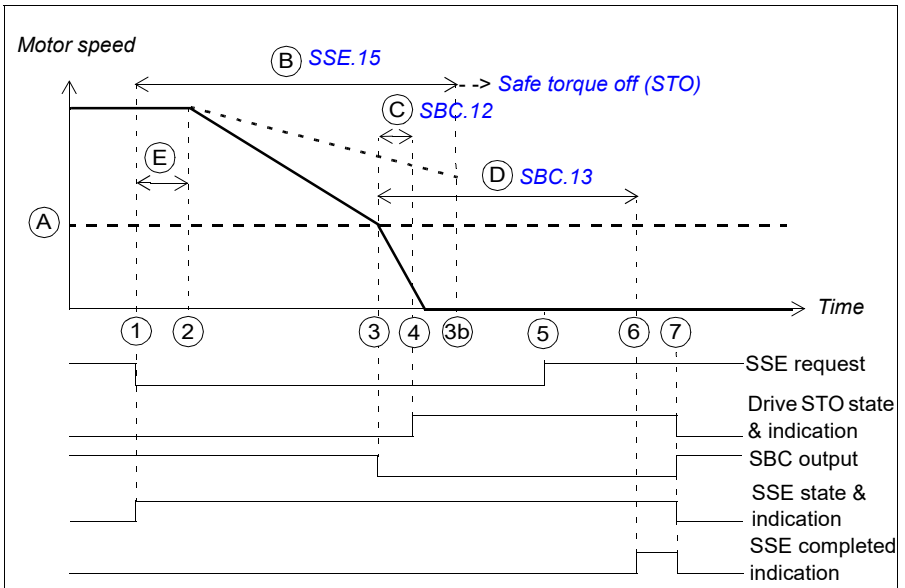

- A SBC speed (parameter [SBC.15](#)): Speed limit below which the FSO activates the SBC function (brake).
- B SSE delay for STO (parameter [SSE.15](#)): Time after which the FSO activates the STO function regardless of the motor speed.
- C SBC delay (parameter [SBC.12](#)): Time from the activation of the SBC function to the moment when the FSO activates the drive STO function.
- D SBC time to zero (parameter [SBC.13](#)): Time from the SBC activation to the moment when the safety function is completed and the SSE completed indication (parameter [SSE.22](#)) goes on. The acknowledgment becomes allowed. You must set this to the estimated time in which the motor brakes to a stop from the maximum speed.
- E Response time (depends on system configuration, see page [532](#))

Step	Description
1	The SSE request is received (for example, from the I/O). The FSO starts a counter for time B. SSE active indication SSE output (SSE.21) goes on.
2	After time E has elapsed, the drive starts to ramp down the motor speed. SAR0 parameter 200.102 defines the deceleration ramp.
3	The motor speed goes below the SBC speed limit (A), the FSO activates SBC function. The FSO starts counters for times C and D. Note: You can define an extra delay (parameter SSE.16 , not shown in the figure) before the FSO activates the SBC function. This affects also the STO activation (step 4).
3b	If the drive has not ramped down fast enough when time B has elapsed, the FSO activates the STO function. See section Safe torque off (STO) on page 68 for more information on how to configure the STO function.
4	After time C has elapsed, the FSO activates the drive STO function. STO active indication parameter STO output (STO.21) goes on when STO is activated.
5	The SSE request is removed.
6	After time D has elapsed, the safety function is completed, the SSE completed indication goes on and the acknowledgement becomes allowed as soon as the SSE request has been removed (step 5).
7	After the acknowledgement, the SSE, STO and SBC functions are deactivated and the control is given back to the drive, which is allowed to modulate again. The indications SSE output (SSE.21) , SSE completed output (SSE.22) , and STO output (STO.21) go off.

With an encoder

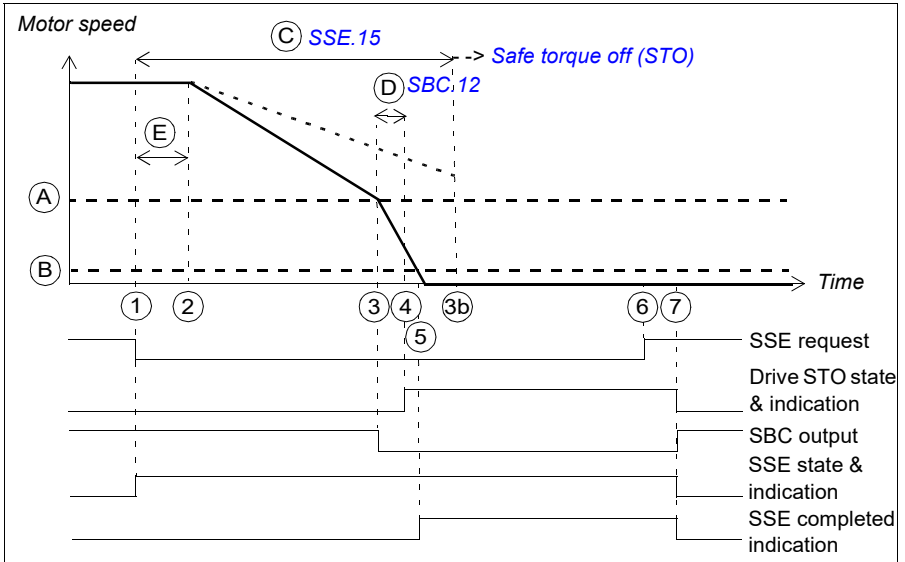

- A SBC speed (parameter [SBC.15](#)): Speed limit below which the FSO activates the SBC function (brake).
- B Zero speed with encoder (parameter [FSOGEN.52](#)): Speed limit to define the motor as stopped. The safety function is completed and the SSE completed indication (parameter [SSE.22](#)) goes on. The acknowledgment becomes allowed.
- C SSE delay for STO (parameter [SSE.15](#)): Time after which the FSO activates the STO function regardless of the motor speed.
- D SBC delay (parameter [SBC.12](#)): Time from the activation of the SBC function to the moment when the FSO activates the drive STO function.
- E Response time (depends on system configuration, see page [532](#))

Step	Description
1	The SSE request is received (for example, from the I/O). The FSO starts a counter for time C. SSE active indication <i>SSE output (SSE.21)</i> goes on.
2	After time E has elapsed, the drive starts to ramp down the motor speed. SAR0 parameter <i>200.102</i> defines the deceleration ramp.
3	The motor speed goes below the SBC speed limit (A), the FSO activates SBC function. The FSO starts counters for time D (parameter <i>SBC.12</i>). Note: You can define an extra delay (parameter <i>SSE.16</i> , not shown in the figure) before the FSO activates the SBC function. This affects also the STO activation (step 4).
3b	If the drive has not ramped down fast enough when time C has elapsed, the FSO activates the STO function. See section <i>Safe torque off (STO)</i> on page 68 for more information on how to configure the STO function.
4	After time D has elapsed, the FSO activates the drive STO function. STO active indication parameter <i>STO output (STO.21)</i> goes on when STO is activated.
5	The motor speed reaches the zero speed limit (B), the SSE completed indication goes on and the acknowledgement becomes allowed as soon as the SSE request has been removed (step 6).
6	The SSE request is removed.
7	After the acknowledgement, the SSE, STO and SBC functions are deactivated and the control is given back to the drive, which is allowed to modulate again. The indications <i>SSE output (SSE.21)</i> , <i>SSE completed output (SSE.22)</i> , and <i>STO output (STO.21)</i> go off.

With ramp monitoring

The operation of the SSE with speed limit activated SBC, SBC before STO and ramp monitoring is described in the time diagrams and tables below. For configuration, see section [How to configure SSE with speed limit activated SBC, SBC before STO](#) on page 362.

With a safe speed estimate

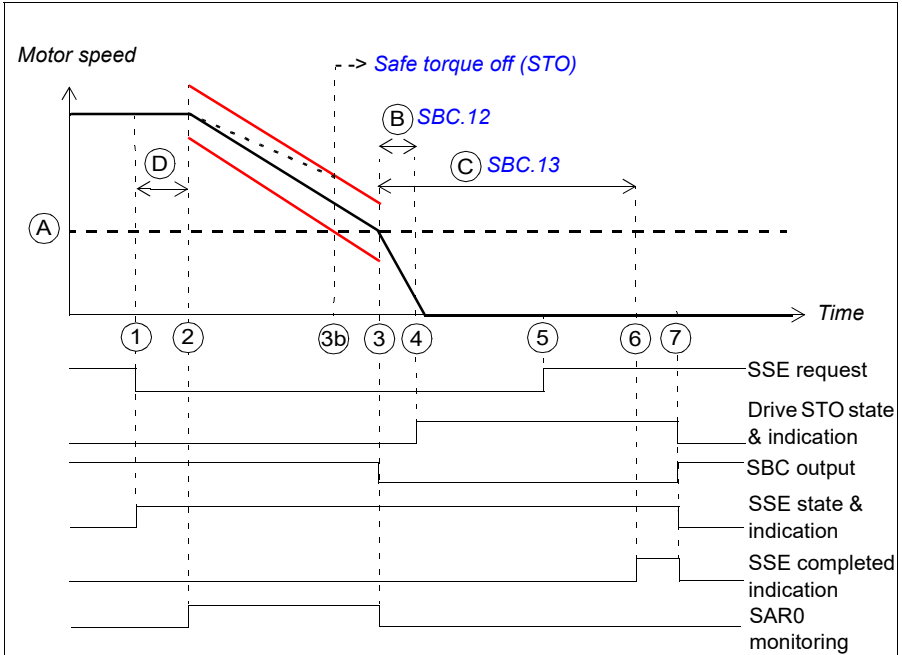

- A SBC speed (parameter [SBC.15](#)): Speed limit below which the FSO activates the SBC (brake) while ramping. The SAR0 ramp monitoring is stopped.
 - B SBC delay (parameter [SBC.12](#)): Time from the activation of the SBC function to the moment when the FSO activates the drive STO function.
 - C SBC time to zero (parameter [SBC.13](#)): Time from the SBC activation to the moment when the safety function is completed and the SSE completed indication (parameter [SSE.22](#)) goes on. The acknowledgment becomes allowed. You must set this to the estimated time in which the motor brakes to a stop from the maximum speed.
 - D Response time (depends on system configuration, see page [532](#))
- Ramp monitoring limits

Step	Description
1	The SSE request is received (for example, from the I/O). SSE active indication <i>SSE output (SSE.21)</i> goes on.
2	After time D has elapsed, the drive starts to ramp down the motor speed. SAR0 parameter <i>200.102</i> defines the deceleration ramp. The FSO starts the SAR0 ramp monitoring (parameters <i>SARx.11</i> and <i>SARx.12</i>).
3	<p>The motor speed goes below the SBC speed limit (A), the FSO stops the SAR0 monitoring and activates the SBC function.</p> <p>The FSO starts counters for times B and C.</p> <p>Note: You can define an extra delay (parameter <i>SSE.16</i>, not shown in the figure) before the FSO activates the SBC function. This affects also the STO activation (step 4).</p>
3b	If the motor speed hits a ramp monitoring limit, the FSO activates the STO function. See section <i>Safe torque off (STO)</i> on page 68 for more information on how to configure the STO function.
4	After time B has elapsed, the FSO activates the drive STO function. STO active indication parameter <i>STO output (STO.21)</i> goes on when STO is activated.
5	The SSE request is removed.
6	After time C has elapsed, the FSO defines the motor as stopped, the SSE completed indication goes on and the acknowledgement becomes allowed as soon as the SSE request has been removed (step 5).
7	After the acknowledgement, the SSE, STO and SBC functions are deactivated and the control is given back to the drive, which is allowed to modulate again. The indications <i>SSE output (SSE.21)</i> , <i>SSE completed output (SSE.22)</i> , and <i>STO output (STO.21)</i> go off.

With an encoder

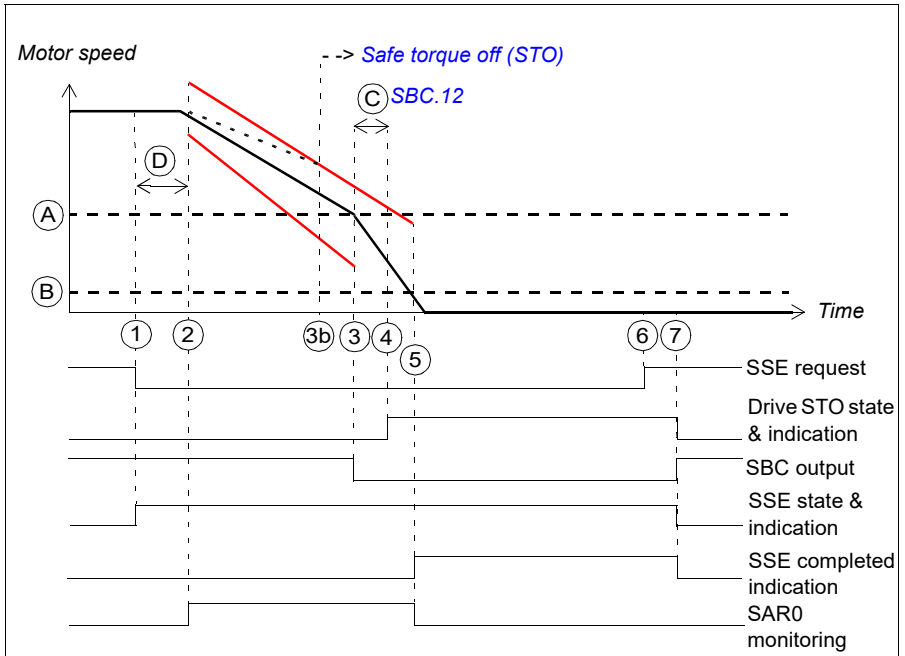

- A SBC speed (parameter [SBC.15](#)): Speed limit below which FSO activates the SBC function (brake) while ramping.
 - B Zero speed with encoder (parameter [FSOGEN.52](#)): Speed limit to define the motor as stopped. The safety function is completed, the SAR0 ramp monitoring is stopped and the SSE completed indication (parameter [SSE.22](#)) goes on. The acknowledgment becomes allowed.
 - C SBC delay (parameter [SBC.12](#)): Time from the activation of the SBC function to the moment when the FSO activates the drive STO function.
 - D Response time (depends on system configuration, see page [532](#))
- Ramp monitoring limits

Step	Description
1	The SSE request is received (for example, from the I/O). SSE active indication <i>SSE output (SSE.21)</i> goes on.
2	After time D has elapsed, the drive starts to ramp down the motor speed. SAR0 parameter <i>200.102</i> defines the deceleration ramp. The FSO starts the SAR0 ramp monitoring (parameters <i>SARx.11</i> and <i>SARx.12</i>).
3	The motor speed goes below the SBC speed limit (A). The FSO activates the SBC function. The FSO starts a counter for time C. Note: You can define an extra delay (parameter <i>SSE.16</i> , not shown in the figure) before the FSO activates the SBC function. This affects also the STO activation (step 4).
3b	If the motor speed hits a ramp monitoring limit, the FSO activates the STO function. See section <i>Safe torque off (STO)</i> on page 68 for more information on how to configure the STO function.
4	After time C has elapsed, the FSO activates the drive STO function. STO active indication parameter <i>STO output (STO.21)</i> goes on when STO is activated.
5	The motor speed reaches the zero speed limit (B), the FSO defines the motor as stopped and stops the SAR0 monitoring. The SSE completed indication goes on and the acknowledgement becomes allowed as soon as the SSE request has been removed (step 6).
6	The SSE request is removed.
7	After the acknowledgement, the SSE, STO and SBC functions are deactivated and the control is given back to the drive, which is allowed to modulate again. The indications <i>SSE output (SSE.21)</i> , <i>SSE completed output (SSE.22)</i> , and <i>STO output (STO.21)</i> go off.

■ SSE when drive modulation is lost during deceleration ramp

The behavior of SSE function in a situation where modulation is lost during deceleration ramp is similar to SS1 function with ramp monitoring, see section *SS1 ramp functions when drive modulation is lost* on page 105.

Safely-limited speed (SLS)

The SLS prevents the motor from exceeding user-defined speed limits. The drive limits the motor speed so that it stays between the SLS speed limits.

If the motor speed is above the user-defined SLS limit when SLS function is activated, the motor speed is first decelerated to the required speed. You can configure the SLS function to use either the time monitoring or ramp monitoring method when the motor speed is decelerated. You can also configure the reaction of the SLS function in case that the drive modulation is lost during the deceleration ramp.

Note: All SLS functions can be active at the same time. Motor speed is limited to the lowest SLS limit. The lowest trip limit will trip the drive.

Time monitoring

When SLS function is activated at a speed higher than SLS limit, motor starts to decelerate according to deceleration ramp time defined by drive parameters. The motor speed must reach SLS monitoring limit within monitoring time limit, otherwise SSE function is activated (see section [SLS with time monitoring and speed above monitored speed](#) on page 144).

Ramp monitoring

When SLS function is activated at a speed higher than SLS limit, motor starts to decelerate according to deceleration ramp slope defined by SLS SAR1 function. The motor speed must decelerate within SAR1 minimum and maximum limits, otherwise STO function is activated (see section [SLS with ramp monitoring and speed above monitored speed](#) on page 146).

If the SLS monitoring must be activated immediately after the SLS request, regardless of the current speed, time monitoring with a zero time delay (parameter [SLSx.04](#)) must be used instead of ramp monitoring.

When the SLS monitoring is active, the FSO monitors and limits the motor speed, but if the motor speed still reaches the SLS trip limit, the FSO module activates the SSE function (see section [SLS trip limit hits](#) on page 168).

SLS reaction when modulation is lost during deceleration ramp

If the user requests the SLS function while the motor speed is above SLS limit, SLS function will trigger a deceleration ramp to bring motor to SLS speed. If the drive modulation is lost during deceleration due to drive error or power failure and FSO is using safe speed estimate for safety function purposes, then FSO does not have the motor speed information anymore and the motor coasts to a stop. When it is critical to receive a safe indication of this situation, FSO parameters can be set accordingly (starting from FSO rev. H). User can select, whether, in the case of modulation loss, STO indication is activated. This lets the user activate, for example, a safe break. The

user can also set the reaction type and the delay for activating the STO indication after the modulation loss.

For this procedure to work, at least the auxiliary power (24 V DC) to the control unit and the FSO module must be on. For more information, see section [SLS reaction when modulation is lost during deceleration ramp, with ramp monitoring](#) on page 148.

■ SLS with speed below monitored speed

This applies to both time and ramp monitoring.

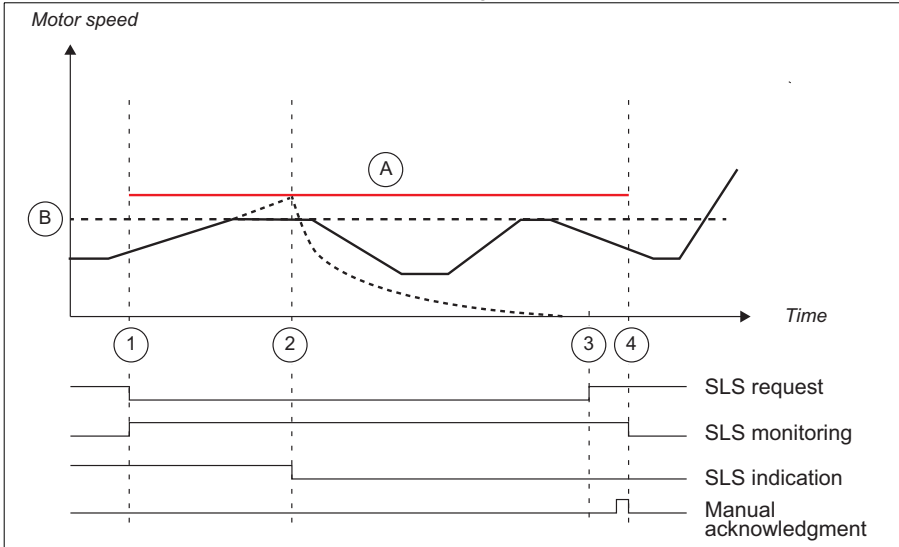

A SLS trip limit positive (parameter [SLSx.14](#), [SLSx.23](#), [SLSx.33](#) or [SLSx.43](#))

B SLS limit positive (parameter [200.23](#), [200.33](#), [200.43](#) or [200.53](#))

--- SSE coast stop due to SLS trip limit hit

Step	Description
1	The SLS request is received. The motor speed is below the SLS limit positive (B) and the FSO starts the SLS monitoring. The SLS active indication (parameter SLSx.15 , SLSx.24 , SLSx.34 or SLSx.44) goes on. The drive limits the motor speed so that it does not go above the SLS limit positive.
2	If the motor speed reaches the SLS trip limit positive (A), the FSO activates the SSE function and the motor coasts to a stop (in this case, the SSE function has been configured as "Immediate STO" (parameter SSE.13), see section SLS trip limit hits on page 168).
3	The SLS request is removed. The SLS monitoring is still on (acknowledgement method is manual or from a safety PLC) (parameter SLSx.02 , configured as Manual_Safebus). Note: If automatic acknowledgement is used, the SLS monitoring is also ended.
4	The SLS function is acknowledged and the FSO stops the SLS monitoring. The SLS active indication (parameter SLSx.15 , SLSx.24 , SLSx.34 or SLSx.44) goes off.

Note: If drive modulation is lost when SLS function is activated and the motor speed is below SLS limit, SLS indication is on and STO is not activated due to loss of drive modulation.

■ SLS with time monitoring and speed above monitored speed

The operation of the SLS function with time monitoring is described in the time diagram and table below. For configuration, see section [How to configure SLSn with time monitoring](#) on page 364.

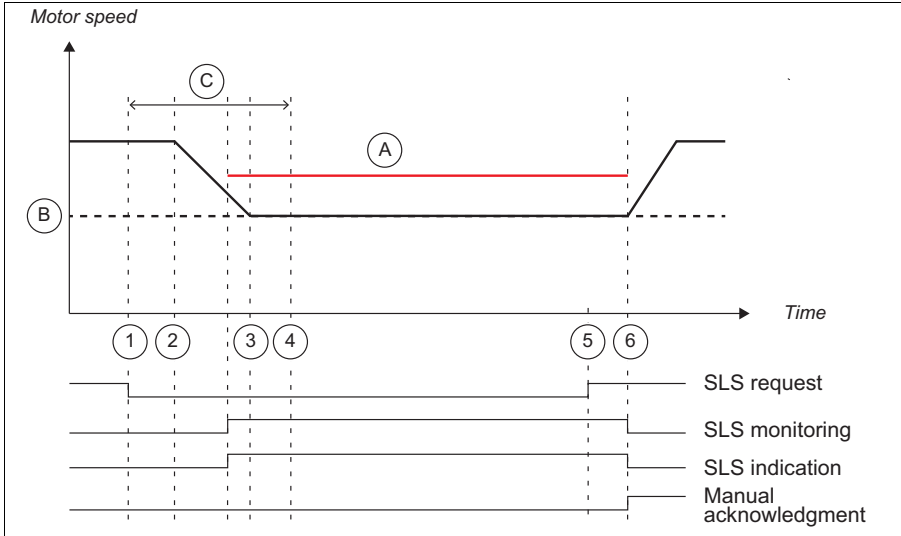

- A SLS trip limit positive (parameter [SLSx.14](#), [SLSx.23](#), [SLSx.33](#) or [SLSx.43](#))
- B SLS limit positive (parameter [200.23](#), [200.33](#), [200.43](#) or [200.53](#))
- C SLS time delay (parameter [SLSx.04](#)): Delay for forcing to start SLS monitoring.

Step	Description
1	The SLS request is received. The motor speed is above the SLS trip limit positive (A). The FSO starts the counter for the SLS time delay (C) (parameter SLSx.04).
2	The drive starts to ramp down the motor speed. The drive (parameter 23.13 or 23.15) defines the deceleration ramp until the speed reaches the SLS limit positive (B). The FSO starts the SLS monitoring when the motor speed is in the middle of the SLS limit and the SLS trip limit (see also section How to configure mute time for monitoring start on page 401). The SLS active indication (parameter SLSx.15 , SLSx.24 , SLSx.34 or SLSx.44) goes on.
3	The motor speed reaches the SLS limit positive (B).
3-6	The drive limits the motor speed, but if the motor speed still reaches the SLS trip limit positive, the FSO activates the SSE function. See section SLS trip limit hits on page 168 .
4	The FSO starts the SLS monitoring at the latest here, that is, after the SLS time delay (C) has elapsed. Note: If the motor speed is above the SLS trip limit after the SLS time delay (C) has elapsed, the FSO module activates the SSE function. For more information, see section SLS trip limit hits on page 168 .
5	The SLS request is removed, but the SLS monitoring is still on (acknowledgement method is manual or from a safety PLC). Note: If automatic acknowledgement is used, the SLS monitoring is also ended.
6	The SLS function is acknowledged and FSO stops the SLS monitoring. The SLS active indication (parameter SLSx.15 , SLSx.24 , SLSx.34 or SLSx.44) goes off.

■ SLS with ramp monitoring and speed above monitored speed

The operation of the SLS function with ramp monitoring is described in the time diagram and table below. For configuration, see section [How to configure SLSn with ramp monitoring](#) on page 366.

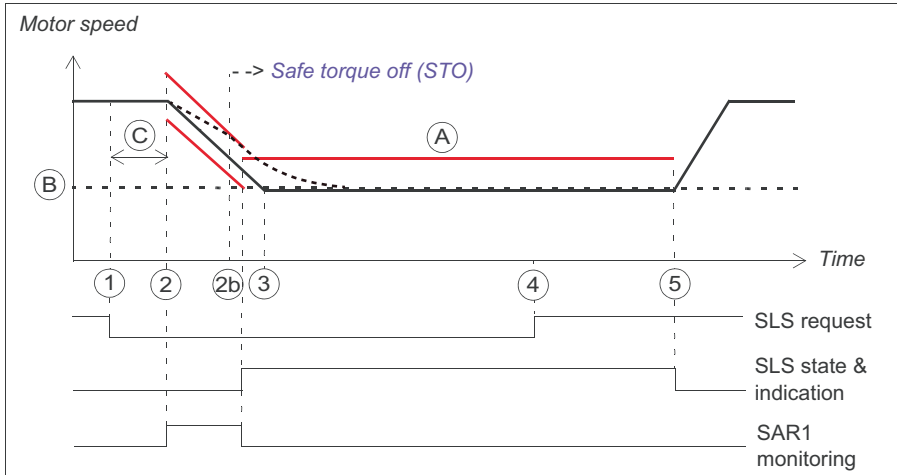

- A SLS trip limit positive (parameter [SLSx.14](#), [SLSx.23](#), [SLSx.33](#) or [SLSx.43](#))
- B SLS limit positive (parameter [200.23](#), [200.33](#), [200.43](#) or [200.53](#))
- C Response time (depends on system configuration, see page 532)
- Ramp monitoring limits (SAR1) or SLS trip limit (A)

Step	Description
1	The SLS request is received. The motor speed is above the SLS trip limit positive (A).
2	<p>After time C has elapsed, the drive starts to ramp down the motor speed. The SAR1 parameter 200.112 defines the deceleration ramp until the speed reaches the SLS limit positive (B). The FSO starts the SAR1 ramp monitoring (parameters SARx.21, SARx.22).</p> <p>Note: If parameter 200.112 has value 0, the drive (parameter 23.23) defines the ramp. The FSO starts the SLS monitoring when the motor speed is in the middle of the SLS limit and the SLS trip limit (see also section How to configure mute time for monitoring start on page 401), and stops the SAR1 monitoring. The SLS active indication (parameter SLSx.15, SLSx.24, SLSx.34 or SLSx.44) goes on.</p>
2b	If the motor speed does not follow the ramp monitoring limits, the FSO activates the STO function. See section Safe torque off (STO) on page 68 for more information on how to configure the STO function.
3	The motor speed reaches the SLS limit positive (B).
3-5	The drive limits the motor speed, but if the motor speed still reaches the SLS trip limit positive, the FSO activates the SSE function. For more information, see section SLS trip limit hits on page 168 .
4	<p>The SLS request is removed, but the SLS monitoring is still on (acknowledgement method is manual or from a safety PLC).</p> <p>Note: If automatic acknowledgement is used, the SLS monitoring is also ended.</p>
5	The SLS function is acknowledged and the FSO stops the SLS monitoring. The SLS active indication (parameter SLSx.15 , SLSx.24 , SLSx.34 or SLSx.44) goes off.

■ SLS reaction when modulation is lost during deceleration ramp, with ramp monitoring

If SLS function is activated when motor speed is above the SLS trip limit, FSO will force the drive to decelerate to SLS limit. If the drive stops modulation during this deceleration ramp, user can pre-select the reaction of the SLS function (parameter SLSx.05) from the following:

- Modoff delay time
- Monitoring active
- Monitoring active and modoff delay time
- Monitoring and modoff delay time disabled.

SLS reaction if modulation is lost with Modoff delay time

The operation of the SLS function in case the modulation of the drive is lost during the deceleration ramp with Modoff delay time selected (parameter SLSx.05 is set to Modoff delay time) is described in the time diagram and table below. For configuration, see section [How to configure SLS function behavior when drive modulation is lost](#) on page 378.

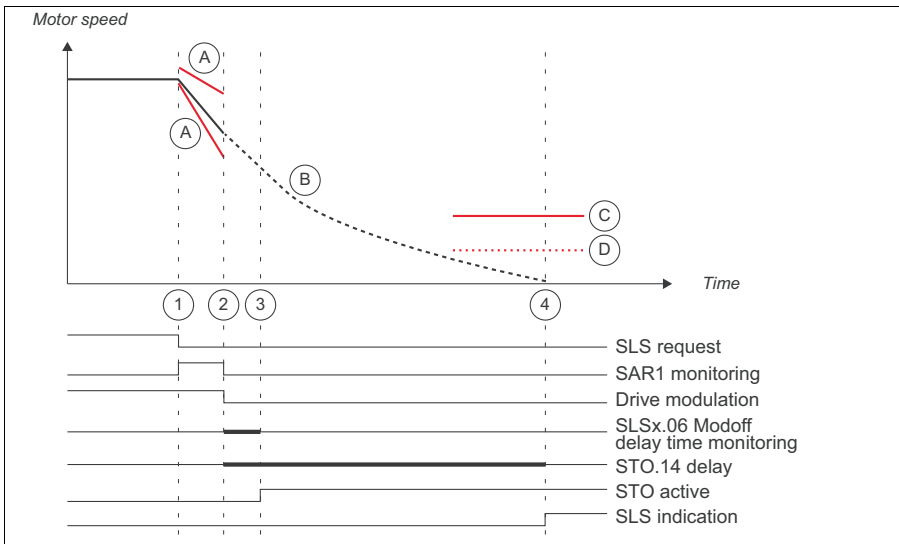

- A SAR1 ramp monitoring
- B Actual motor speed (coasting after modoff)
- C SLS trip limit
- D SLS limit

Step	Description
1	<p>The SLS request is received. The motor speed is above the SLS trip limit positive (A). The drive starts to ramp down the motor speed. The SAR1 parameter 200.112 defines the deceleration ramp slope until the speed reaches the SLS limit. The FSO starts the SAR1 ramp monitoring (parameters SARx.21, SARx.22). SAR1 configuration defines the target and monitoring limits for the deceleration ramp (SARx.22, 200.112, SARx.02).</p> <p>Note: If parameter 200.112 has value 0, the drive (parameter 23.23) defines the ramp.</p>
2	<p>The drive trips on a fault, there is a drive power loss, or user stops the drive by coast stop. SAR1 monitoring of the FSO is switched off. SLS Modoff delay time starts (parameters SLSx.05 & SLSx.06). STO.14 delay starts.</p> <p>Note: This reaction is the default for FSO and the delay time is set to 0 ms.</p>
3	<p>Modulation of the drive has not returned and the SLSx.06 Modoff delay time has run out, and FSO activates STO function and STO indication (parameter STO.21 STO output). See section Safe torque off (STO) on page 68 for more information on how to configure the STO function.</p>
4	<p>If modulation does not return, and STO.14 delay has elapsed, SLS indication goes on.</p>

SLS reaction if modulation is lost with Modoff delay time - modulation returns before modoff delay

The operation of the SLS function in case of the modulation of the drive is lost during the deceleration ramp and the modulation returns before the Modoff delay time has run out with Modoff delay time selected (parameter *SLsX.05* is set to Modoff delay time) is described in the time diagram and table below.

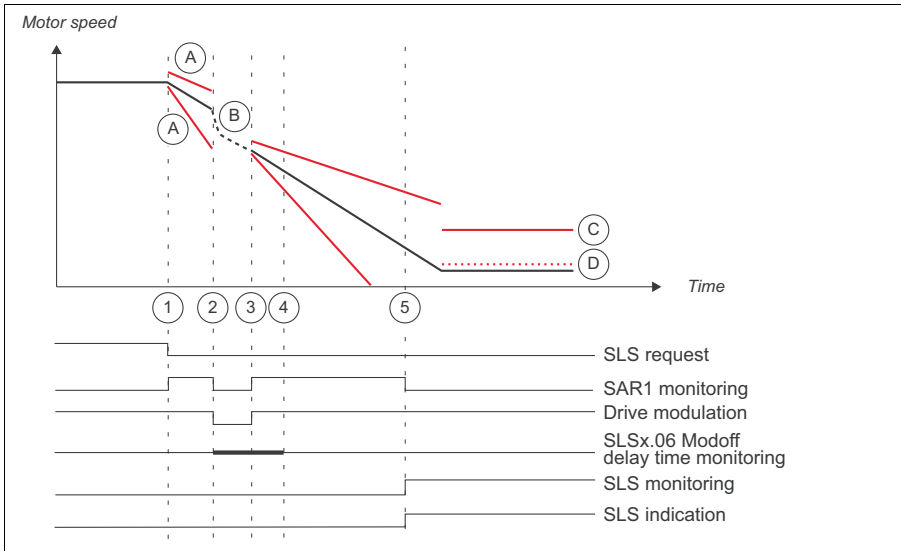

- A SAR1 ramp monitoring
- B Actual motor speed (coasting after modoff)
- C SLS trip limit
- D SLS limit

Step	Description
1	<p>The SLS request is received. The motor speed is above the SLS trip limit positive (A). The drive starts to ramp down the motor speed. The SAR1 parameter 200.112 defines the deceleration ramp slope until the speed reaches the SLS limit. The FSO starts the SAR1 ramp monitoring (parameters SARx.21, SARx.22). SAR1 configuration defines the target and monitoring limits for the deceleration ramp (SARx.22, 200.112, SARx.02).</p> <p>Note: If parameter 200.112 has value 0, the drive (drive parameter 23.23) defines the ramp.</p>
2	<p>The drive trips on a fault, there is a drive power loss, or user stops the drive by coast stop. SAR1 monitoring of the FSO is switched off. SLS Modoff delay time starts (parameters SLSx.05 & SLSx.06). STO.14 delay starts.</p>
3	<p>Modulation of the drive returns. FSO activates SAR1 monitoring again with same ramps as when the SLS request was set.</p>
4	<p>The Modoff delay time limit. If the modulation would not return before this time, see previous case.</p>
5	<p>The FSO starts the SLS monitoring when the motor speed is in the middle of the SLS limit and the SLS trip limit (see also section How to configure mute time for monitoring start on page 401), and stops the SAR1 monitoring. The SLS indication (parameter SLSx.15, SLSx.24, SLSx.34 or SLSx.44) goes on.</p>

SLS reaction if modulation is lost with Monitoring active

The operation of the SLS function in case the modulation of the drive is lost during the deceleration ramp with Monitoring active selected (parameter *SLsX.05* is set to Monitoring active) is described in the time diagram and table below. For configuration, see section [How to configure SLS function behavior when drive modulation is lost](#) on page 378.

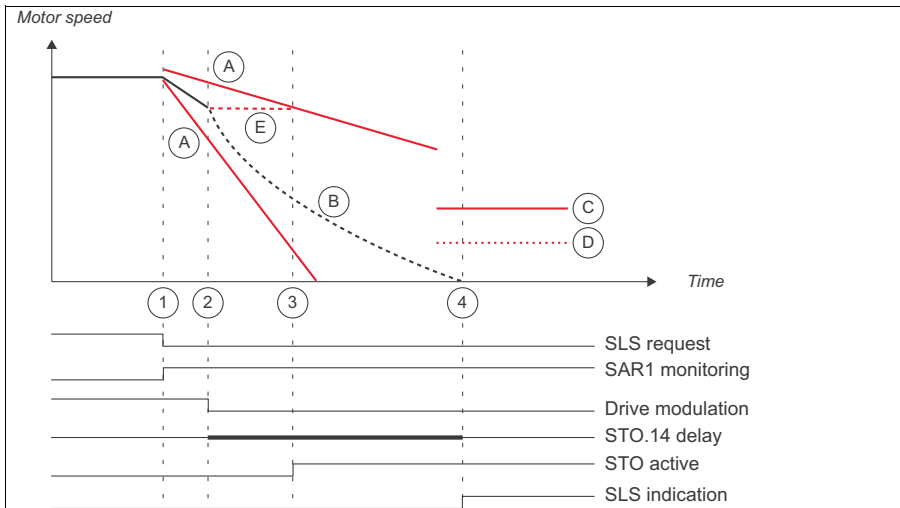

- A SAR1 ramp monitoring
- B Actual motor speed (coasting after modoff)
- C SLS trip limit
- D SLS limit
- E Last valid speed estimate of FSO

Step	Description
1	<p>The SLS request is received. The motor speed is above the SLS trip limit positive (A). The drive starts to ramp down the motor speed. The SAR1 parameter 200.112 defines the deceleration ramp slope until the speed reaches the SLS limit. The FSO starts the SAR1 ramp monitoring (parameters SARx.21, SARx.22). SAR1 configuration defines the target and monitoring limits for the deceleration ramp (SARx.22, 200.112, SARx.02).</p> <p>Note: If parameter 200.112 has value 0, the drive (drive parameter 23.23) defines the ramp.</p>
2	<p>The drive trips on a fault, there is a drive power loss, or user stops the drive by coast stop. SAR1 monitoring of the FSO is on (parameter SLSx.05 configured as Monitoring active). As the modulation is lost, FSO's safe speed estimation is stopped and it starts to use the last speed information that it had before the modulation was lost. With SLSx.06 Monitor active, SAR1 monitoring stays active also when the modulation is lost from the drive.</p> <p>STO.14 delay starts.</p>
3	<p>Modulation of the drive has not returned and the safe speed estimation with the last valid speed information hits the SAR1 monitoring and FSO activates STO function and STO indication (parameter STO.21 STO output). See section Safe torque off (STO) on page 68 for more information on how to configure the STO function.</p> <p>If the modulation returns before the last valid speed estimation of FSO hits the SAR1 monitoring limit, the drive will continue the deceleration for as long as the speed stays within the SAR1 ramp monitoring limits.</p>
4	<p>SLS indication goes on after STO.14 delay has elapsed.</p>

SLS reaction if modulation is lost with Monitoring active and modoff delay time - modulation returns

The operation of the SLS function in case the modulation of the drive is lost during the deceleration ramp with Monitoring active and modoff delay time selected (parameter *SL_{Sx.05}* is set to Monitoring active and modoff delay time) is described in the time diagram and table below. For configuration, see section [How to configure SLS function behavior when drive modulation is lost](#) on page 378.

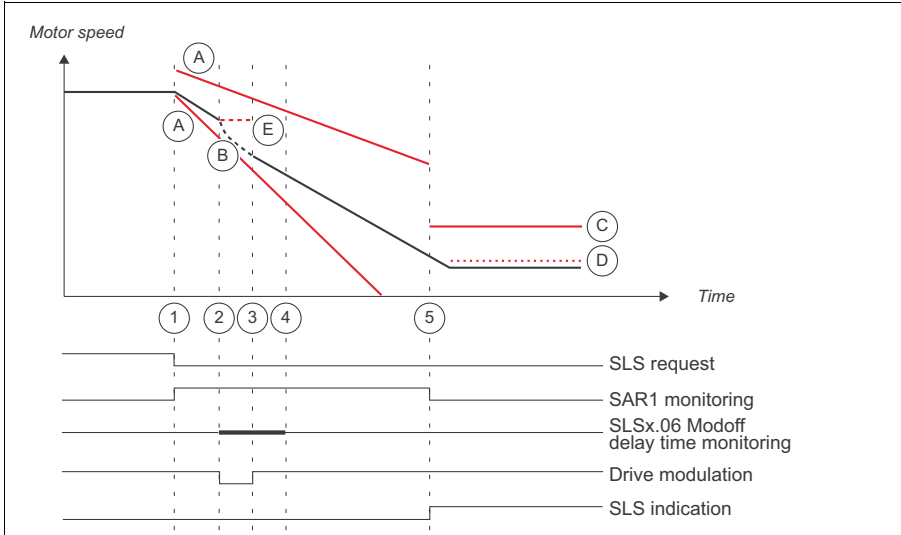

- A SAR1 ramp monitoring
- B Actual motor speed (coasting after modoff)
- C SLS trip limit
- D SLS limit
- E Last valid speed estimate of FSO

Step	Description
1	<p>The SLS request is received. The motor speed is above the SLS trip limit positive (A). The drive starts to ramp down the motor speed. The SAR1 parameter 200.112 defines the deceleration ramp slope until the speed reaches the SLS limit. The FSO starts the SAR1 ramp monitoring (parameters SARx.21, SARx.22). SAR1 configuration defines the target and monitoring limits for the deceleration ramp (SARx.22, 200.112, SARx.02).</p> <p>Note: If parameter 200.112 has value 0, the drive (drive parameter 23.23) defines the deceleration time.</p>
2	<p>The drive trips on a fault, there is a drive power loss, or user stops the drive by coast stop.</p> <p>SAR1 monitoring of the FSO is on (parameter SLSx.05 configured as Monitoring active and modoff delay time).</p> <p>SLS Modoff delay time starts (parameters SLSx.05 & SLSx.06).</p> <p>As the modulation is lost, FSO's safe speed estimation is stopped and it starts to use the last speed information that it had before the modulation was lost.</p>
3	<p>Modulation of the drive returns before the last valid speed information hits the SAR1 limit and before the modoff delay time has run out.</p> <p>Deceleration continues as parametrized as long as the speed does not hit the SAR1 limits.</p>
4	<p>If modulation of the drive has not returned and the SLSx.06 Modoff delay time has run out or the last valid speed reaches the SAR limit, FSO activates STO function and STO indication (parameter STO.21 STO output). See section Safe torque off (STO) on page 68 for more information on how to configure the STO function.</p>
5	<p>The FSO starts the SLS monitoring when the motor speed is in the middle of the SLS limit and the SLS trip limit (see also section How to configure mute time for monitoring start on page 401), and stops the SAR1 monitoring. The SLS indication (parameters SLSx.15, SLSx.24, SLSx.34 or SLSx.44) goes on.</p>

SLS reaction if modulation is lost with Monitoring and modoff delay time disabled

The operation of the SLS function in case the modulation of the drive is lost during the deceleration ramp with Monitoring and modoff delay time disabled selected (parameter *SLSx.05* is set to Monitoring and modoff delay time disabled) is described in the time diagram and table below. For configuration, see section [How to configure SLS function behavior when drive modulation is lost](#) on page 378.

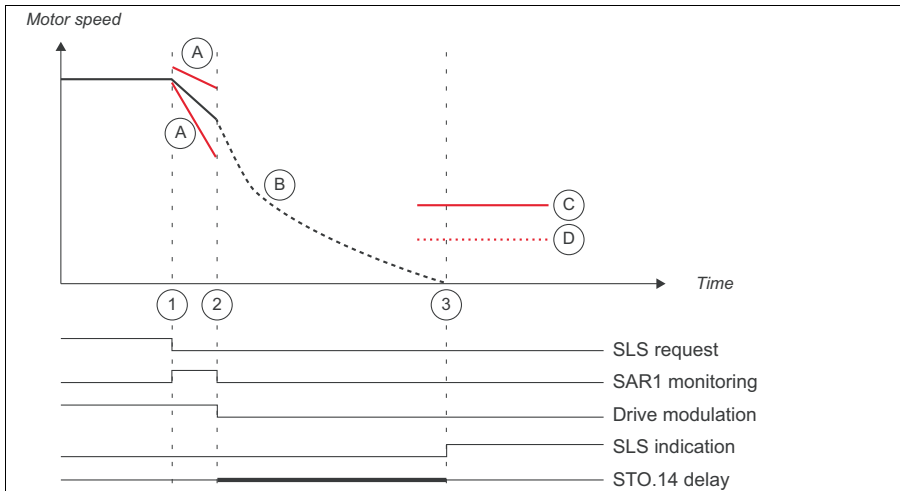

- A SAR1 ramp monitoring
- B Actual motor speed (coasting after modoff)
- C SLS trip limit
- D SLS limit

Step	Description
1	<p>The SLS request is received. The motor speed is above the SLS trip limit positive (A). The drive starts to ramp down the motor speed. The SAR1 parameter 200.112 defines the deceleration ramp slope until the speed reaches the SLS limit. The FSO starts the SAR1 ramp monitoring (parameters SARx.21, SARx.22). SAR1 configuration defines the target and monitoring limits for the deceleration ramp (SARx.22, 200.112, SARx.02).</p> <p>Note: If parameter 200.112 has value 0, the drive (parameter 23.23) defines the ramp.</p>
2	<p>The drive trips on a fault, there is a drive power loss, or user stops the drive by coast stop.</p> <p>SAR1 monitoring of the FSO is switched off (parameter SLSx.05 configured as Monitoring and modoff delay time are disabled).</p> <p>SLS Modoff delay time monitoring is not in use.</p> <p>STO.14 delay starts.</p>
3	<p>The SLS indication (parameter SLSx.15, SLSx.24, SLSx.34 or SLSx.44) goes on after STO.14 has elapsed.</p>

If the drive modulation returns before the [STO.14](#) delay has run out, the deceleration continues as parametrized and the SAR1 monitoring is set on again.

SLS reaction when modulation is lost during deceleration ramp, with time monitoring

SLS reaction if modulation is lost with Modoff delay time

The operation of the SLS function in case the modulation of the drive is lost during the deceleration ramp with Modoff delay time selected (parameter [SLSx.05](#) is set to Modoff delay time) is described in the time diagram and table below. For configuration, see section [How to configure SLS function behavior when drive modulation is lost](#) on page 378.

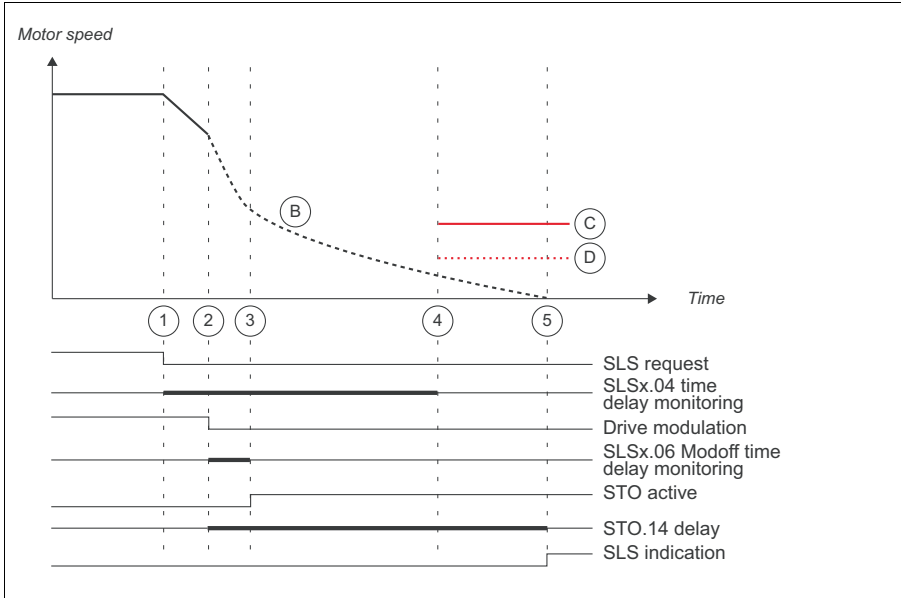

- B Actual motor speed (coasting after modoff)
- C SLS trip limit
- D SLS limit

Step	Description
1	<p>The SLS request is received. The motor speed is above the SLS trip limit positive (A). The drive starts to ramp down the motor speed. The FSO starts the SLS time delay (parameter SLSx.04). The drive (parameter 23.13 or 23.15) defines the deceleration ramp until the speed reaches the SLS limit.</p>
2	<p>The drive trips on a fault, there is a drive power loss, or user stops the drive by coast stop. SLS Modoff delay time starts (parameters SLSx.05 & SLSx.06). STO.14 delay starts.</p>
3	<p>Modulation of the drive has not returned, the SLSx.06 Modoff delay time has run out, and FSO activates STO function and STO indication (parameter STO.21 STO output). See section Safe torque off (STO) on page 68 for more information on how to configure the STO function.</p>
4	<p>SLSx.04 time delay for SLS time monitoring</p>
5	<p>SLS indication goes on after STO.14 delay has elapsed.</p>

SLS reaction if modulation is lost with Modoff delay time - modulation returns before modoff delay

The operation of the SLS function in case the modulation of the drive is lost during the deceleration ramp and the modulation returns before the Modoff delay time has run out with Modoff delay time selected (parameter *SLSx.05* is set to Modoff delay time) is described in the time diagram and table below.

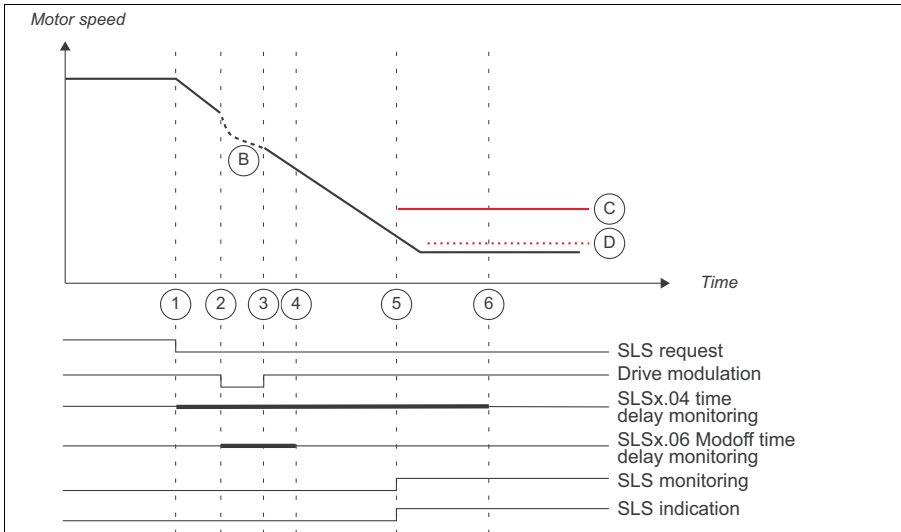

- B Actual motor speed (coasting after modoff)
- C SLS trip limit
- D SLS limit

Step	Description
1	<p>The SLS request is received. The motor speed is above the SLS trip limit positive (A). The drive starts to ramp down the motor speed. The FSO starts the counter for the SLS time delay (C) (parameter SLCx.04) The drive (parameter 23.13 or 23.15) defines the deceleration ramp until the speed reaches the SLS limit.</p>
2	<p>The drive trips on a fault, there is a drive power loss, or user stops the drive by coast stop. SLS Modoff delay time starts (parameters SLCx.05 & SLCx.06).</p>
3	<p>Modulation of the drive returns before the SLCx.06 Modoff delay time has run out.</p>
4	<p>Modoff delay time limit. If the modulation would not return before this time, see previous case.</p>
5	<p>Speed is below the monitoring limit and SLS monitoring is started.</p>
6	<p>The FSO starts the SLS monitoring at the latest here, that is, after the SLS time delay has elapsed. The FSO starts the SLS monitoring when the motor speed is in the middle of the SLS limit and the SLS trip limit (see also section How to configure mute time for monitoring start on page 401). The SLS indication (parameters SLCx.15, SLCx.24, SLCx.34 or SLCx.44) goes on.</p>

SLS reaction if modulation is lost with Monitoring active

The operation of the SLS function in case the modulation of the drive is lost during the deceleration ramp with Monitoring active selected (parameter *SLSx.05* is set to Monitoring active) is described in the time diagram and table below. For configuration, see section [How to configure SLS function behavior when drive modulation is lost](#) on page 378.

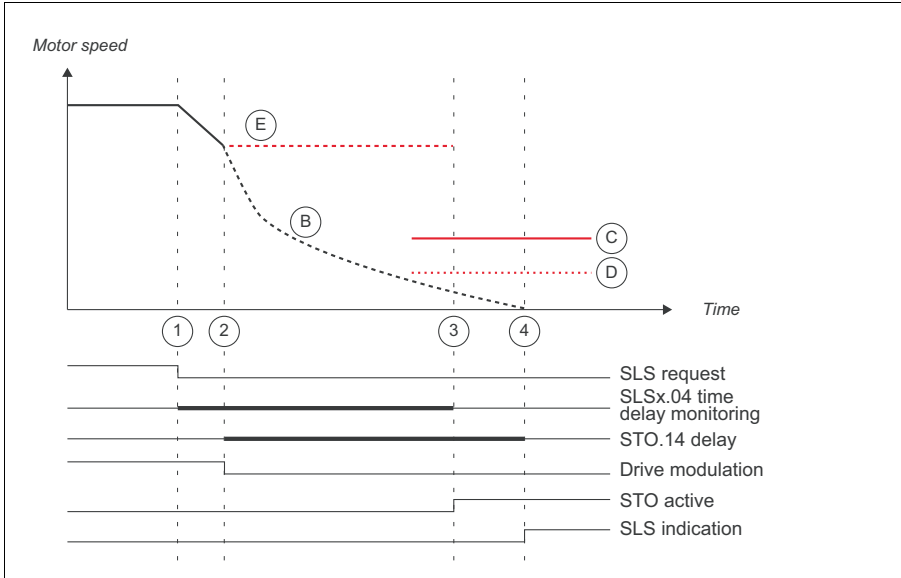

- B Actual motor speed (coasting after modoff)
- C SLS trip limit
- D SLS limit
- E Last valid speed estimate of FSO

Step	Description
1	<p>The SLS request is received. The motor speed is above the SLS trip limit positive (A). The drive starts to ramp down the motor speed. The FSO starts the counter for the SLS time delay (C) (parameter SLsX.04). The drive (parameter 23.13 or 23.15) defines the deceleration ramp until the speed reaches the SLS limit.</p>
2	<p>The drive trips on a fault, there is a drive power loss, or user stops the drive by coast stop. STO.14 delay starts. As the modulation is lost, FSO's safe speed estimation is stopped and it starts to use the last speed information that it had before the modulation was lost.</p>
3	<p>Modulation of the drive has not returned and the safe speed estimation with the last valid speed information of the motor speed is above the SLS trip limit after the SLS time delay has elapsed. FSO module activates the SSE function. SSE function triggers STO function because the modulation is lost and it cannot activate any deceleration ramp in this case. For more information, see section SLS trip limit hits on page 168. If the modulation returns before the last valid speed estimation of FSO has hit the SLS time delay limit, the drive will continue the deceleration until SLS monitoring or time monitoring limit is reached. If the motor speed is above the SLS trip limit after the SLS time delay has elapsed, the FSO module activates the SSE function.</p>
4	<p>If modulation does not return, SLS indication goes on after STO.14 delay has elapsed.</p>

SLS reaction if modulation is lost with Monitoring and modoff delay time disabled

The operation of the SLS function in case the modulation of the drive is lost during the deceleration ramp with Monitoring and modoff delay time disabled selected (parameter *SLSx.05* is set to Monitoring and modoff delay time disabled) is described in the time diagram and table below. For configuration, see section [How to configure SLS function behavior when drive modulation is lost](#) on page 378.

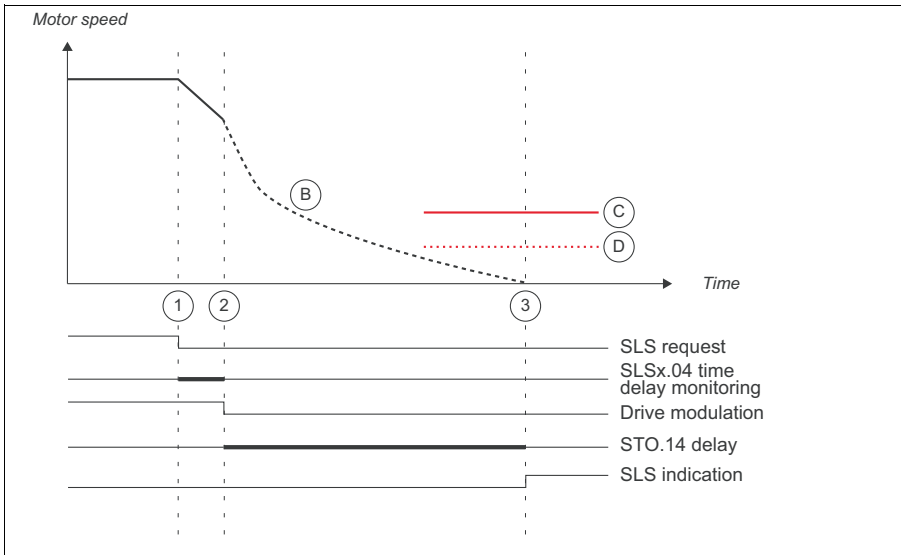

- B Actual motor speed (coasting after modoff)
- C SLS trip limit
- D SLS limit

Step	Description
1	The SLS request is received. The motor speed is above the SLS trip limit positive (A). The drive starts to ramp down the motor speed. The drive (parameter 23.13 or 23.15) defines the deceleration ramp until the speed reaches the SLS limit. The FSO starts the counter for the SLS time delay (C) (parameter <i>SLSx.04</i>)
2	The drive trips on a fault, there is a drive power loss, or user stops the drive by coast stop. Here, STO is not activated due to loss of modulation. <i>STO.14</i> delay starts.
3	If modulation does not return, SLS indication goes on after <i>STO.14</i> delay has elapsed.

SLS reaction if modulation is lost with Monitoring and modoff delay time disabled - modulation returns

The operation of the SLS function in case the modulation of the drive is lost during the deceleration ramp with Monitoring and modoff delay time disabled selected (parameter *SLsX.05* is set to Monitoring and modoff delay time disabled) is described in the time diagram and table below. For configuration, see section [How to configure SLS function behavior when drive modulation is lost](#) on page 378.

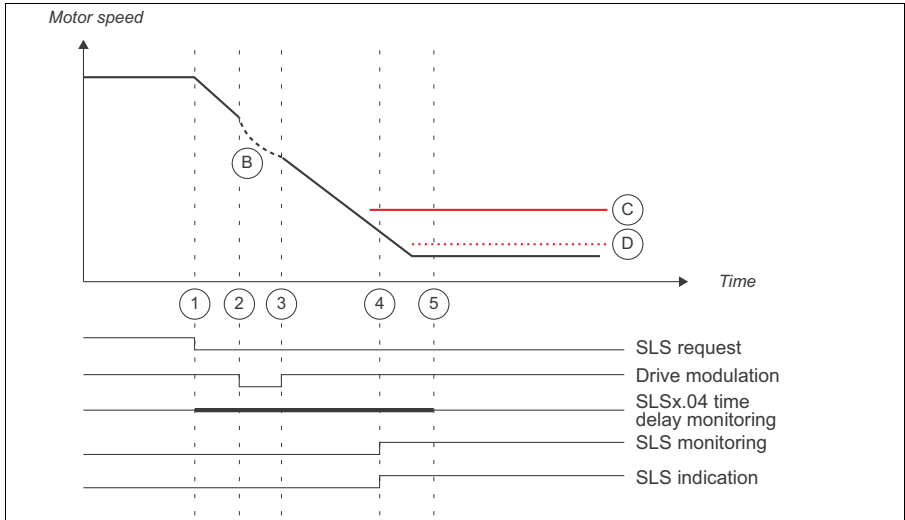

- B Actual motor speed (coasting after modoff)
- C SLS trip limit
- D SLS limit

Step	Description
1	<p>The SLS request is received. The motor speed is above the SLS trip limit positive (A). The drive starts to ramp down the motor speed. The drive (parameter 23.13 or 23.15) defines the deceleration ramp until the speed reaches the SLS limit. The FSO starts the counter for the SLS time delay (C) (parameter SLSx.04).</p>
2	<p>The drive trips on a fault, there is a drive power loss, or user stops the drive by coast stop. SLS delay time monitoring is switched off (parameter SLSx.04) as Monitoring and modoff delay time are disabled. FSO starts to wait until the STO.14 delay has run out or modulation returns.</p>
3	<p>The drive modulation returns. Deceleration continues toward SLS limit speed.</p>
4	<p>FSO starts the SLS monitoring when the motor speed is in the middle of the SLS limit and the SLS trip limit (see also section How to configure mute time for monitoring start on page 401). The SLS indication goes on.</p>
5	<p>FSO starts the SLS monitoring at the latest here, that is, after the SLS time delay has elapsed.</p>

Note: With time-monitored SLS: If modulation is lost during deceleration ramp but it returns after [SLSx.04](#) delay time has elapsed, with motor speed higher than SLS trip limit, then SLS limit hit is generated.

■ FSO boot behavior with SLS active

When the safe speed estimate is in use, the following boot behavior exists.

During FSO module boot, the FSO module has no valid speed data and thus a very high initialization value for motor speed is assumed for internal FSO usage. If an SLS function or variable SLS function is active during FSO reboot and parameter *SLSx.05* is configured so that *Modoff delay time* or *Monitoring active* is selected, the FSO will prevent the drive from restarting until the *STO.14* delay time has elapsed.

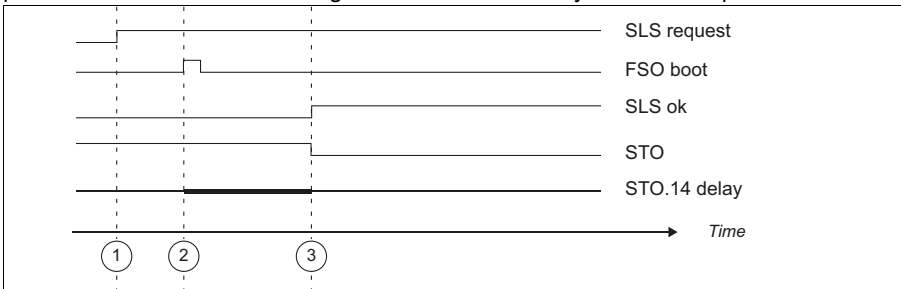

Step	Description
1	SLS request is active during FSO boot.
2	FSO module is rebooted. <i>STO.14</i> delay time counter is started.
3	<i>STO.14</i> has elapsed, STO acknowledgement is possible, and SLS indication is activated. Note: STO acknowledgement is not possible until <i>STO.14</i> delay has elapsed. If you try to acknowledge STO before <i>STO.14</i> delay has elapsed, <i>STO.14</i> delay time counter will be restarted.

■ SLS trip limit hits

If the motor speed exceeds an SLS trip limit, the FSO activates the SSE function. The operation of SLS and SSE indications in SLS trip limit hit situations are described in the diagrams and tables below. For more information on the SSE function, see section [Safe stop emergency \(SSE\)](#) on page 107.

SSE with immediate STO, with a safe speed estimate

This applies when the SSE function has been configured as “Immediate STO”.

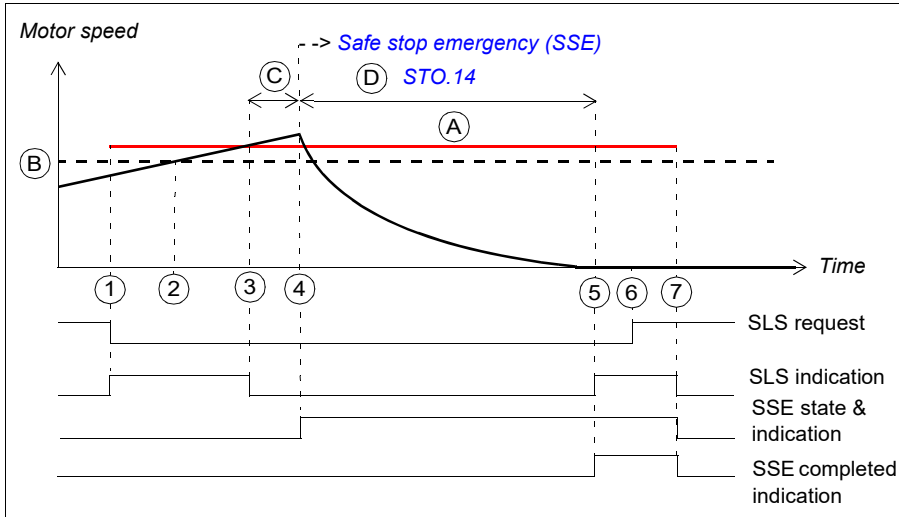

- A SLS trip limit positive (parameter [SLCx.14](#), [SLCx.23](#), [SLCx.33](#) or [SLCx.43](#))
- B SLS limit positive (parameter [200.23](#), [200.33](#), [200.43](#) or [200.53](#))
- C Response time (depends on system configuration, see page 532)
- D Time to zero speed (parameter [STO.14](#))
- SLS trip limit (A)

Step	Description
1	The SLS request is received, the motor speed is below the SLS limit positive (B) and the FSO starts the SLS monitoring. The SLS indication (parameter SLSx.15 , SLSx.24 , SLSx.34 or SLSx.44) goes on.
2	The motor speed goes above the SLS limit positive (B).
3	The motor speed reaches the SLS trip limit positive (A). The SLS indication goes off.
4	After time C has elapsed, the FSO activates the SSE function, opens the drive STO circuit and the motor coasts to a stop.
5	After time D has elapsed, the motor has stopped and the SLS active indication goes on (speed is below the SLS limit positive). The SSE completed indication goes on. Note: If the SBC is configured in the SSE function, parameter SBC.13 is used here instead of STO.14 .
6	The SLS request is removed. The SLS monitoring is still on (acknowledgement method is manual or from a safety PLC).
7	The SLS function is acknowledged and the FSO stops the SLS monitoring. The SSE function is acknowledged with the same acknowledgement. The indications go off.

SSE with immediate STO, with an encoder

This applies when the SSE function has been configured as “Immediate STO” and an encoder is used.

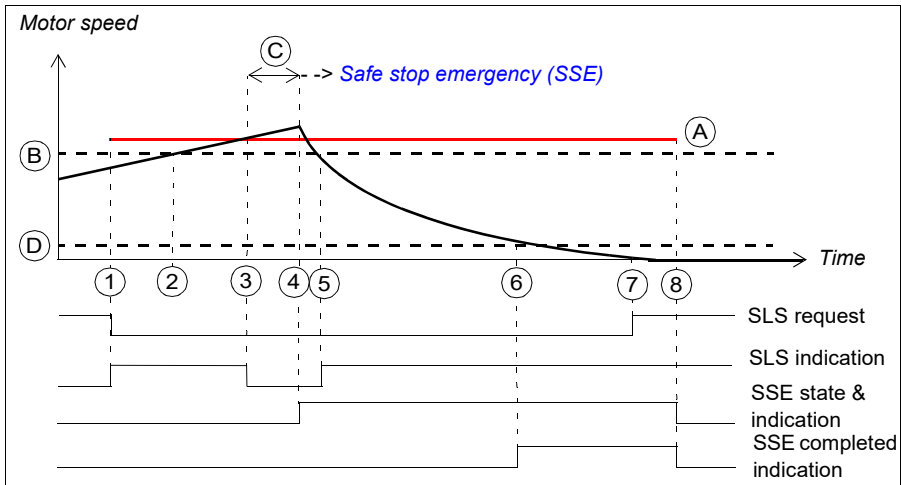

- A SLS trip limit positive (parameter [SLSx.14](#), [SLSx.23](#), [SLSx.33](#) or [SLSx.43](#))
- B SLS limit positive (parameter [200.23](#), [200.33](#), [200.43](#) or [200.53](#))
- C Response time (depends on system configuration, see page [532](#))
- D Zero speed limit (parameter [FSOGEN.52](#)): Speed limit to define the motor as stopped. The safety function is completed and the SSE completed indication (parameter [SSE.22](#)) goes on. The acknowledgment becomes allowed.

— SLS trip limit (A)

Step	Description
1	The SLS request is received, the motor speed is below the SLS limit positive (B) and the FSO starts the SLS monitoring. The SLS indication (parameter SLSx.15 , SLSx.24 , SLSx.34 or SLSx.44) goes on.
2	The motor speed goes above the SLS limit positive (B).
3	The motor speed reaches the SLS trip limit positive (A). The SLS active indication goes off.
4	After time C, the FSO activates the SSE function, opens the drive STO circuit and the motor coasts to a stop.
5	The motor speed goes below the SLS limit positive (B). The SLS indication goes on.
6	The motor speed reaches the zero speed limit (D). The motor has stopped and the SSE completed indication goes on.
7	The SLS request is removed. The SLS monitoring is still on (acknowledgement method is manual or from a safety PLC).
8	The SLS function is acknowledged and the FSO stops the SLS monitoring. The SSE function is acknowledged with the same acknowledgement. The indications go off.

SSE with emergency ramp

This applies when the SSE function has been configured as “Emergency ramp” (with ramp monitoring or time monitoring).

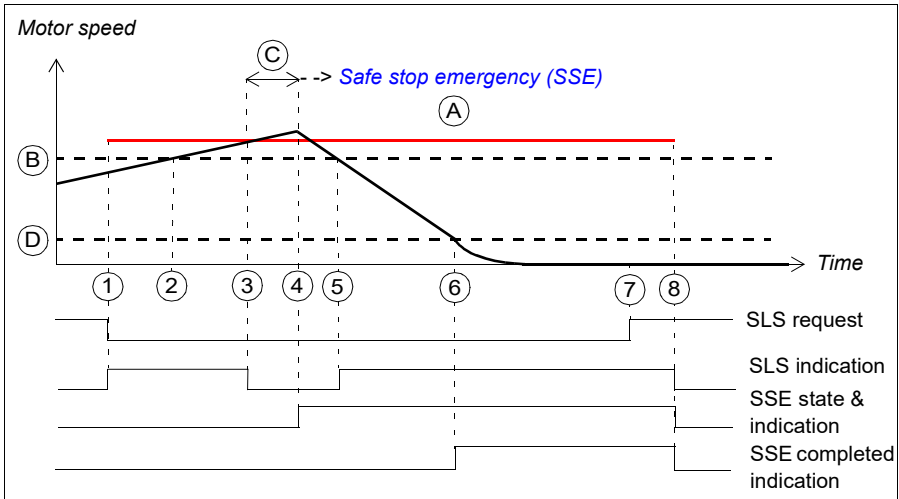

- A SLS trip limit positive (parameter [SLCx.14](#), [SLCx.23](#), [SLCx.33](#) or [SLCx.43](#))
- B SLS limit positive (parameter [200.23](#), [200.33](#), [200.43](#) or [200.53](#))
- C Response time (depends on system configuration, see page [532](#))
- D Zero speed limit (parameter [FSOGEN.51](#) or [FSOGEN.52](#)): Speed limit to define the motor as stopped. The safety function is completed and the SSE completed indication (parameter [SSE.22](#)) goes on. The acknowledgment becomes allowed.

— SLS trip limit (A)

Step	Description
1	The SLS request is received, the motor speed is below the SLS limit positive (B) and the FSO starts the SLS monitoring. The SLS indication (parameter SLCx.15 , SLCx.24 , SLCx.34 or SLCx.44) goes on.
2	The motor speed goes above the SLS limit positive (B).
3	The motor speed reaches the SLS trip limit positive (A). The SLS active indication goes off.
4	After time C has elapsed, the FSO activates the SSE function and the drive starts the ramp down the motor speed. SAR0 parameter 200.102 defines the ramp.
5	The motor speed goes below the SLS limit positive (B) and the SLS active indication goes on.
6	The motor speed reaches the zero speed limit (D). The motor has stopped and the FSO opens the drive STO circuit. The SSE completed indication goes on.
7	The SLS request is removed. The SLS monitoring is still on (acknowledgement method is manual or from a safety PLC).

Step	Description
8	The SLS function is acknowledged and the FSO stops the SLS monitoring. The SSE function is acknowledged with the same acknowledgement. The indications go off.

Variable Safely-limited speed (SLS)

This safety function requires that FSO communicates with a safety-capable PLC via PROFIsafe over PROFINET. For more information, see chapter [PROFIsafe](#).

The SLS function prevents the motor from exceeding user-defined speed limits. With the Variable SLS function, the speed limits are scaled with a safety PLC via PROFIsafe bus and can be changed on the fly.

If the motor speed reaches the SLS trip limit, the FSO module activates the SSE function (see section [SLS trip limit hits](#) on page 168). If the motor speed reaches a ramp monitoring limit during deceleration, the FSO module activates the STO function. With time monitoring, the FSO module starts to monitor motor speed after SLS time delay has elapsed, and if the speed is above the SLS trip limit, the FSO activates the SSE function.

The SLS function with fixed limits and the SMS function can be active at the same time with the Variable SLS function. In this case, the FSO module limits the motor speed according to the lowest speed limit.

The safety PLC sends the Variable SLS request to the FSO module in a PROFIsafe message. The message includes a scaling value as a percentage (%). The scaling value is used to scale the original SLS and trip limits (SLS4 parameters) to new, scaled values. The FSO module uses these scaled values until a new scaling value is received from the safety PLC.

The Variable SLS limits cannot be scaled above the SLS4 limits.

In the PROFIsafe message, the bits that are used to configure the Variable SLS function are:

- `Positive_Scaling`: defines whether the positive SLS limits are scaled or not.
- `Negative_Scaling`: defines whether the negative SLS limits are scaled or not.
- `Variable_SLS_limit` (MSB and LSB): defines the scaling value. For example, if the value set in `Variable_SLS_limit` = 5000, the scaling value is 50%.

Note: Do not add a plus or a minus sign (+ / -) in front of the scaling value for the `Variable_SLS_limit`. Use a scaling value smaller than 100.

The same scaling value is applied to both the positive and the negative limits. For more information, see section [ABB_PS1 profile F-Output user data](#) on page 204.

For more information on how the FSO module defines the scaled limits, see section [Defining the scaled SLS4 limit and SLS4 trip limits](#) on page 372.

For more information on drive modulation loss during SLS deceleration ramp, see [SLS reaction when modulation is lost during deceleration ramp, with ramp monitoring](#) on page 148 and [SLS reaction when modulation is lost during deceleration ramp, with time monitoring](#) on page 158.

Variable SLS with time monitoring

In Variable SLS with time monitoring, the ramp according to which the drive decelerates the motor to different speeds is monitored using the time monitoring method. Drive parameters define the deceleration ramp. If the motor speed is accelerated, drive parameters define the acceleration ramp and it is not monitored.

For configuration, see section [How to configure Variable SLS with time monitoring](#) on page 368.

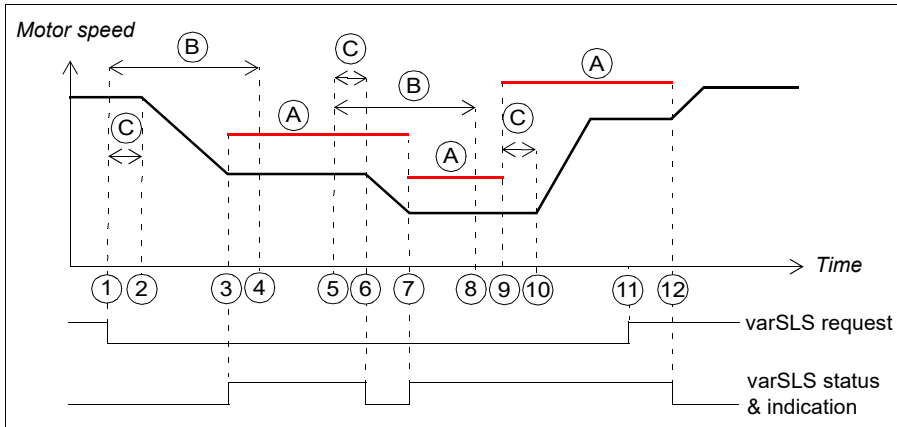

- A Variable SLS trip limits (parameter [SLSx.43](#) and the scaling values set in the safety PLC)
- B SLS time delay (parameter [SLSx.04](#)): Delay for forcing to start SLS monitoring.
- C Response time (depends on system configuration, see page [532](#))
- Variable SLS trip limit (A)

Step	Description
1	The Variable SLS request is received from the safety PLC (for example, 70%). The FSO sends a request to the drive to ramp down the motor speed to the new SLS speed limit. The FSO start a counter for the SLS time delay (B).
2	After time C has elapsed, the drive starts to ramp down the motor speed. The drive (parameter 23.13 or 23.15) defines the deceleration ramp. The FSO starts the SLS monitoring when the motor speed is in the middle of the new SLS limit and the SLS trip limit (see also section How to configure mute time for monitoring start on page 401).
3	The new motor speed has been reached. The Variable SLS active indication (parameter SLSx.51) goes on.
4	The FSO starts the SLS monitoring at the latest here, that is, after the SLS time delay (B) has elapsed. Note: If the motor speed is above the SLS trip limit after the SLS time delay (B) has elapsed, the FSO module activates the SSE function. For more information, see section SLS with time monitoring and speed above monitored speed on page 144 .

Step	Description
5	<p>The Variable SLS request is received again from the safety PLC (for example, 50%). The FSO sends a request to the drive to ramp down the motor speed to the new speed limit. The FSO starts a counter for the SLS time delay (B).</p> <p>Note: The FSO continues to monitor the existing Variable SLS limits until the new speed limit has been reached.</p> <p>Note: If variable SLS limits are rescaled before previous limits have been reached, time monitoring delay SLSx.04 starts from the beginning.</p>
6	<p>After time C has elapsed, the drive starts to ramp down the motor speed. Drive parameters define the deceleration ramp. The Variable SLS active indication goes off (see also section How to configure limit hit situations on page 396).</p> <p>The FSO starts the SLS monitoring when the motor speed is in the middle of the new SLS limit and the SLS trip limit (see also section How to configure mute time for monitoring start on page 401).</p>
7	<p>The new motor speed has been reached. The SLS active indication goes on.</p>
8	<p>The FSO starts the SLS monitoring with the new SLS limits at the latest here, that is, after the SLS time delay (B) has elapsed.</p>
9	<p>The Variable SLS request is received again from the safety PLC (100%). The FSO sends a request to the drive to accelerate the motor speed to the new speed limit. The FSO starts to monitor the motor speed according to the new SLS limits.</p>
10	<p>After time C has elapsed and if the motor speed is lower than the new speed limit, the drive accelerates the motor speed to the requested speed.</p>
11	<p>The Variable SLS request is removed from the safety PLC (acknowledgement method is manual or from a safety PLC).</p> <p>Note: If automatic acknowledgement is used, the Variable SLS monitoring is also ended.</p>
12	<p>The Variable SLS is acknowledged, the FSO stops the SLS monitoring and the drive continues with the speed reference set by the user. The Variable SLS indication (parameter SLSx.51) goes off.</p>

Note: For more information on the modoff functionality in a situation where drive modulation is lost during SLS deceleration ramp, see chapter [SLS reaction when modulation is lost during deceleration ramp, with ramp monitoring](#) on page 148, and [SLS reaction when modulation is lost during deceleration ramp, with time monitoring](#) on page 158).

■ Variable SLS with ramp monitoring

In Variable SLS with ramp monitoring, the ramp according to which the drive decelerates the motor to different speeds is monitored using the ramp monitoring method (SAR1 parameters of the FSO module). Drive or SAR1 parameters define the deceleration ramp. If the motor speed is accelerated, drive parameters define the acceleration ramp and it is not monitored.

For configuration, see section [How to configure Variable SLS with ramp monitoring](#) on page 368.

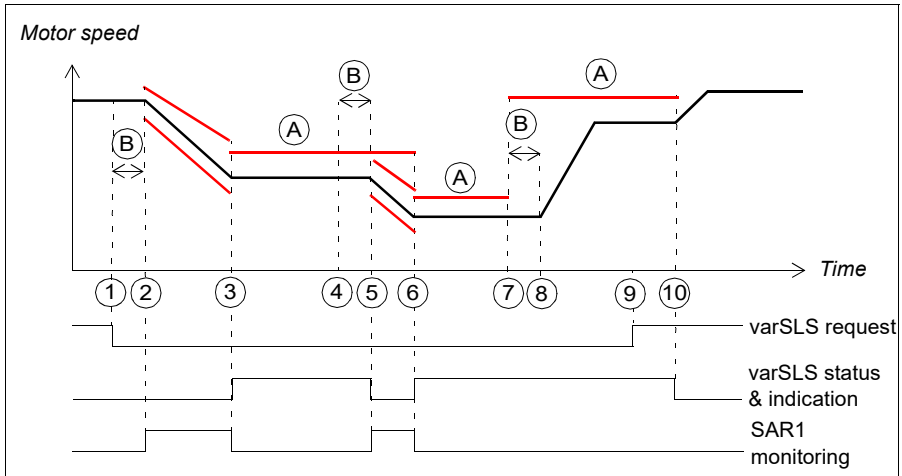

A Variable SLS trip limits (parameter [SL_{Sx}.43](#) and the scaling values set in the safety PLC)

B Response time (depends on system configuration, see page 532)

— Ramp monitoring limits or Variable SLS trip limit (A)

Step	Description
1	The Variable SLS request is received from the safety PLC (for example, 70%). The FSO sends a request to the drive to ramp down the motor speed to the new speed limit.
2-3	After time B has elapsed, the drive starts to ramp down the motor speed. SAR1 parameter 200.112 defines the deceleration ramp. The FSO starts to monitor the ramp according to SAR1 parameters (SAR_x.21 , SAR_x.22). Note: If parameter 200.112 has value 0, the drive (parameter 23.23) defines the ramp. Note: If the motor speed does not follow the ramp, the FSO activates the STO function. The FSO starts the SLS monitoring when the motor speed is in the middle of the new SLS limit and the SLS trip limit (see also section How to configure mute time for monitoring start on page 401).
3	The new motor speed has been reached. The Variable SLS active indication (parameter SL_{Sx}.51) goes on.

Step	Description
4	The Variable SLS request is received again from the safety PLC (for example, 50%). The FSO sends a request to the drive to ramp down the motor speed to the new speed limit.
5	After time B has elapsed, the drive starts to ramp down the motor speed. SAR1 parameter 200.112 defines the deceleration ramp. The FSO starts to monitor the ramp with SAR1 parameters (SARx.21 , SARx.22). The Variable SLS indication goes off (see also section How to configure limit hit situations on page 396). Note: The FSO continues to monitor the existing Variable SLS limits until the new speed limit has been reached.
6	The new motor speed has been reached and the FSO starts to monitor the motor speed according to the new SLS limits. The Variable SLS active indication goes on.
7	The Variable SLS request is received again from the safety PLC (100%). The FSO sends a request to the drive. The FSO starts to monitor the motor speed according to the new SLS limits.
8	After time B has elapsed and if the motor speed is lower than the new speed limit, the drive accelerates the motor speed to the requested speed.
9	The Variable SLS request is removed from the safety PLC (acknowledgement method is manual or from a safety PLC). Note: If automatic acknowledgement is used, the Variable SLS monitoring is also ended.
10	The Variable SLS is acknowledged and the FSO stops the SLS monitoring. The drive continues with the speed reference set by the user. The Variable SLS indication (parameter SLSx.51) goes off.

Safe maximum speed (SMS)

The SMS function is used to protect the machine from too high speeds/frequencies. You can configure it to be permanently on or off. There are two different versions of the SMS function:

1. **Version 1:** If the motor speed reaches the minimum or the maximum SMS trip limit, the FSO module activates the SSE function.
2. **Version 2:** The minimum and maximum SMS limits limit the motor speed. This version of the SMS function is similar to the SLS function except that it can only be permanently on or off.

The required version of the SMS function is selected with FSO parameters.

You can configure the minimum and maximum SMS and SMS trip limits separately.

■ SMS function, version 1

The operation of the SMS function, version 1 is described in the time diagram and table below. For configuration, see section [How to configure SMS, version 1](#) on page 376.

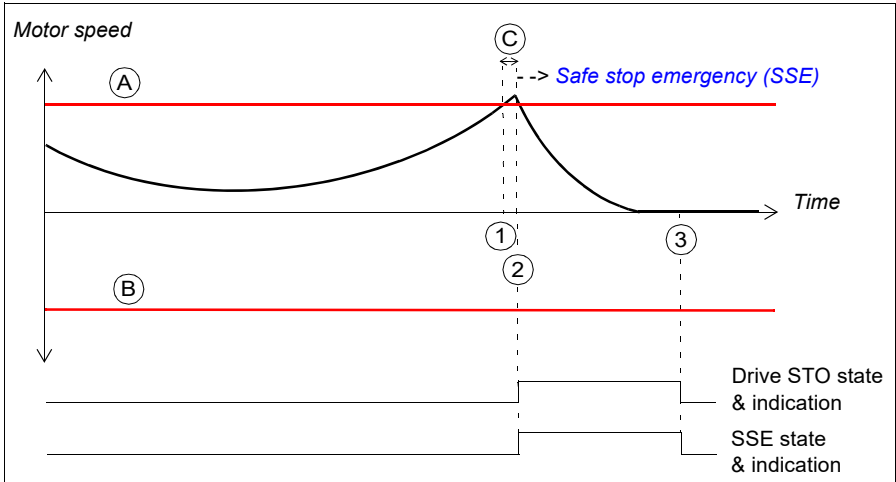

- A SMS trip limit positive (parameter [SMS.14](#))
- B SMS trip limit negative (parameter [SMS.13](#))
- C Response time (depends on system configuration, see page [532](#))
- SMS trip limits (A and B)

Step	Description
1	The motor speed reaches the SMS trip limit positive (A).
2	<p>After time C has elapsed, the FSO activates the SSE function. In this case, the SSE function has been configured as “Immediate STO” (parameter SSE.13). This opens the drive STO circuit immediately and the motor coasts to a stop. The STO and SSE indications go on.</p> <p>Note: If SBC is used, it is activated according to SBC configuration settings (see the note on page 50). See section Safe stop emergency (SSE) on page 107 for more information on how to configure the SSE function.</p>
3	After the SSE function has been completed, the FSO acknowledges the SSE function (in this case, automatic acknowledgement is used) and deactivates the SSE and drive STO functions. The indications go off.

■ SMS function, version 2

The operation of the SMS function, version 2 is described in the time diagram and table below. For configuration, see section [How to configure SMS, version 2](#) on page 377.

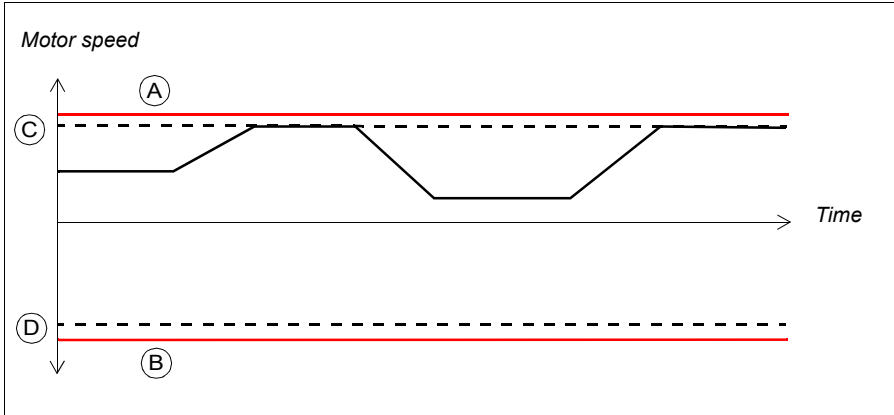

- A SMS trip limit positive (parameter [SMS.14](#))
- B SMS trip limit negative (parameter [SMS.13](#))
- C SMS limit positive (parameter [200.73](#))
- D SMS limit negative (parameter [200.72](#))
- SMS trip limits (A and B)

The drive limits the motor speed so that it stays between the SMS limit positive and negative. If the motor speed still hits the SMS trip limit positive or negative, the FSO module activates the SSE function (see section [Safe stop emergency \(SSE\)](#) on page 107 for more information on how to configure the SSE function).

If you use the SMS function, version 2 and you need to remove the FSO module from the drive, do these steps:

1. Re-configure the FSO module so that the SMS function, version 2 is deactivated (set parameter [200.71 SMS activity and version](#) to *Disabled*). For more information, see chapter [Configuration](#).
2. Remove the FSO module from the drive.

This removes the SMS limits from the drive. Unnecessary limits can affect the normal operation of the drive.

Prevention of unexpected start-up (POUS)

The POUS function prevents the machine from starting unexpectedly. The POUS function activates the Safe torque off (STO) function in the drive.



WARNING! The situations in which you can use the POUS function must always be based on a risk assessment (see IEC 60204-1:2016).

For more information on the STO function in the ACS880/DCS880 drives, see the corresponding drive hardware manual.

The operation of the POUS function is described in the time diagram and table below. For configuration, see section [Configuring POUS](#) on page 378.

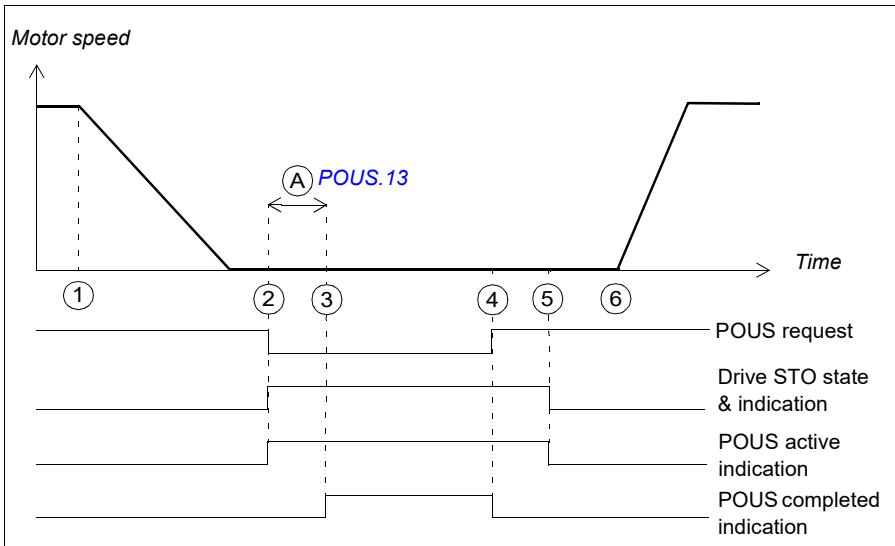

- A POUS delay for completion (parameter [POUS.13](#)): Sets a delay for POUS completed indication. The POUS completed indication (parameter [POUS.22](#)) goes on after this delay.

Note: POUS function does not activate SBC function, even if SBC is configured into use together with the STO function.

Step	Description
1	The user stops the motor.
2	<p>The user activates the POUS function. The FSO activates the drive STO function and starts a counter for time A. The POUS active indication (parameter <i>POUS.21</i>) and the STO active indication (parameter <i>STO.21</i>) become active.</p> <p>Note: If the user activates the POUS function when the motor is running, the FSO activates the drive STO function, generates a fault (7A97) and the motor coasts to a stop.</p>
3	<p>After time A has elapsed, the POUS completed indication becomes active (parameter <i>POUS.22</i>).</p> <p>Note: Connect the POUS indication lamp to this indication signal.</p>
4	<p>The user removes the POUS request. The POUS completed indication is deactivated. The acknowledgement becomes allowed.</p> <p>Note: If the user activates the POUS request again before the POUS function has been acknowledged, the counter for time A is restarted and the POUS completed indication is activated after this delay.</p>
5	<p>The user acknowledges the POUS function. The POUS active indication goes off. The FSO deactivates the drive STO function and the user can restart the motor.</p> <p>Note: If automatic acknowledgement is used, this happens already when the POUS request is removed (step 4).</p>
6	The user starts the motor.

Safe speed monitor (SSM)

The SSM function provides a safe output signal to indicate whether the motor speed is between user-defined limits. There are four separate SSM functions (SSM1...SSM4) with separate monitoring limits and indications. Several SSM functions can be active at the same time.

You can configure the SSM function to be permanently on or off, or to be activated externally from the FSO module I/O or from a safety PLC.

You can use the SSM function with a safety encoder or with a safe speed estimate. With an encoder, the FSO module is always aware of the exact motor speed. Without an encoder, the speed information is valid only when the drive is modulating (see section [SSM with a safe speed estimate](#) on page 185).

Note: If there is a fault in the speed data and the SSM function is the only active safety function, this does not trip the drive. This only removes the SSM indication and generates a warning to the drive.

The operation of the SSM function is described in the time diagrams and tables below. The SSM1 function is used as an example. For configuration, see section [Configuring SSM](#) on page 389.

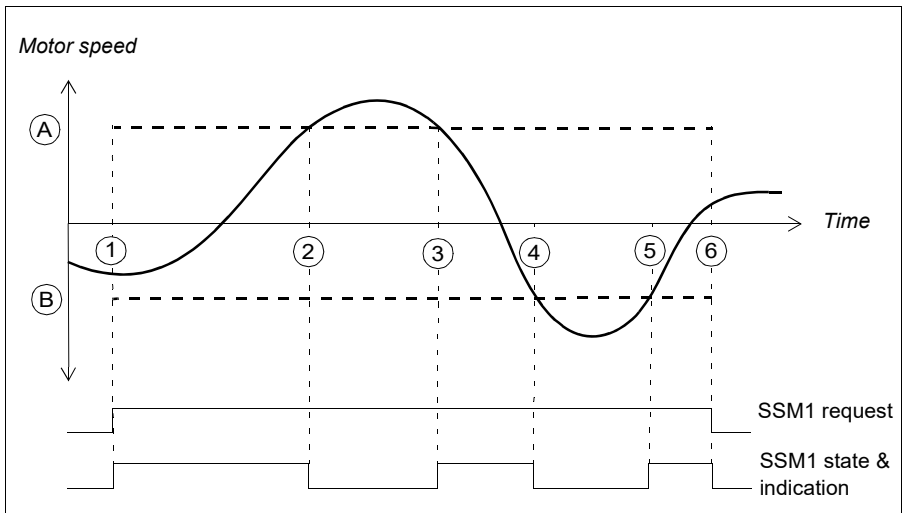

A SSM1 limit positive (parameter [SSMx.13](#))

B SSM1 limit negative (parameter [SSMx.12](#))

--- SSM limits (A and B)

Step	Description
1	The SSM1 request is received (for example, from the I/O) and the FSO starts the SSM1 monitoring. The motor speed is between the SSM1 limit positive (A) and SSM1 limit positive (B). The SSM1 indication goes on.
2	The motor speed goes above the SSM1 limit positive (A), the SSM1 indication goes off.
3	The motor speed goes below the SSM1 limit positive (A), the SSM1 indication goes on.
4	The motor speed goes below the SSM1 limit negative (B), the SSM1 indication goes off.
5	The motor speed goes above the SSM1 limit negative (B), the SSM1 indication goes on.
6	The SSM1 request is removed and the FSO stops the SSM1 monitoring. The SSM1 indication goes off.

■ SSM with a safe speed estimate

This section describes situations when an encoder is not used and the drive stops modulating when the SSM monitoring is on.

Case A: This applies when the drive stops modulating after the SSM monitoring limit has been reached.

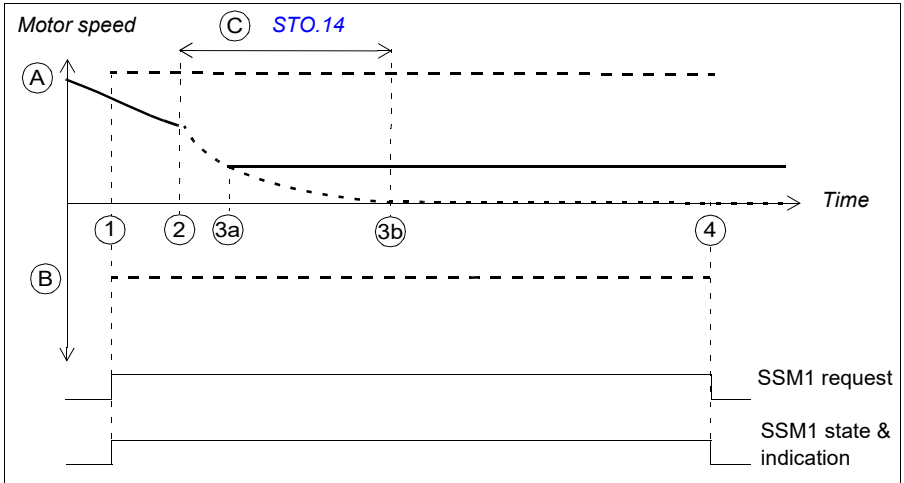

- A SSM1 limit positive (parameter [SSMx.13](#))
 - B SSM1 limit negative (parameter [SSMx.12](#))
 - C Time to zero speed (parameter [STO.14](#)): When the drive stops modulating, SSM1 indication goes on after this delay.
- ■ ■ SSM limits (A and B)

Step	Description
1	The SSM1 request is received (for example, from the I/O) and the FSO starts the SSM1 monitoring. The motor speed is between the SSM1 limit positive (A) and SSM1 limit positive (B). The SSM1 indication goes on.
2	The drive stops modulating and the FSO starts a counter for time C. The motor speed starts to decelerate. While the drive is not modulating, the state of the FSO outputs is based on the latest speed information from modulation.
3a	The drive starts to modulate again and the FSO receives the actual motor speed again. The motor speed is between the SSM1 limit positive (A) and SSM1 limit positive (B), and the SSM1 indication stays on.
3b	Time C has elapsed, but the drive is still not modulating. The FSO assumes that the motor has stopped. The motor speed is still between the SSM1 limit positive (A) and SSM1 limit positive (B), and the SSM1 indication stays on.
4	SSM1 request is removed and the FSO stops the SSM1 monitoring. The SSM1 indication goes off.

Case B: This applies when the drive stops modulating before the SSM monitoring limit has been reached.

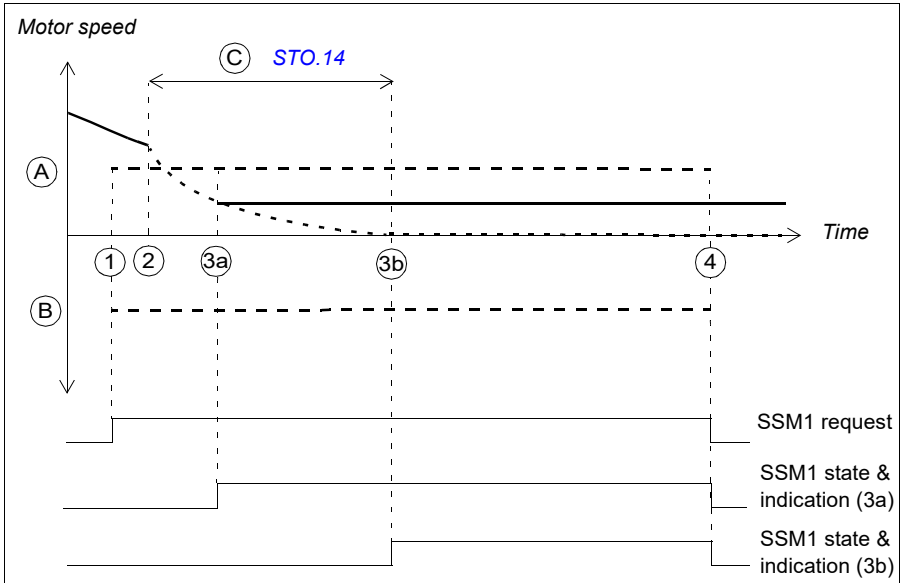

- A SSM1 limit positive (parameter [SSMx.13](#))
- B SSM1 limit negative (parameter [SSMx.12](#))
- C Time to zero speed (parameter [STO.14](#)): When the drive stops modulating, SSM1 indication goes on after this delay.
- SSM limits (A and B)

Step	Description
1	The SSM1 request is received (for example, from the I/O) and the FSO starts the SSM1 monitoring. The motor speed is not between the SSM1 limit positive (A) and SSM1 limit positive (B). The SSM1 indication is off.
2	The drive stops modulating and the FSO starts a counter for time C. The motor speed starts to decelerate. While the drive is not modulating, the state of the FSO outputs is based on the latest speed information from modulation.
3a	The drive starts to modulate again and the FSO receives the actual motor speed again. The motor speed is between the SSM1 limit positive (A) and SSM1 limit positive (B), and the SSM1 indication goes on.
3b	Time C has elapsed, but the drive is still not modulating. The FSO assumes that the motor has stopped.
4	The SSM1 request is removed and the FSO stops the SSM1 monitoring. The SSM1 indication goes off.

Safe direction (SDI)

This safety function requires that you use an encoder in the safety application.

The SDI function monitors that the motor rotates into the correct direction. There are separate functions to monitor the positive and negative directions. You can activate them separately.

The SDI functions can be configured to be always on or off, or to be activated externally from the FSO module I/O or from a safety PLC.

When the SDI function is active, the drive limits the speed reference so that the user cannot set it to the forbidden direction. If the motor rotates into the forbidden direction more than the user-defined SDI tolerance limit allows, the FSO module activates the SSE function and the motor stops.

If the motor does not rotate in the correct direction when the SDI function is activated, the motor speed is first decelerated to zero speed. You can configure the SDI function to use either the time monitoring or ramp monitoring method when the motor speed is decelerated. After the user has given a new speed reference, the motor starts to rotate to the correct direction.

■ SDI with correct rotation direction

This applies when the motor rotates into the correct direction when the SDI function is activated. The SDI positive function is used as an example.

Note: This diagram shows the position of the motor shaft (not the motor speed).

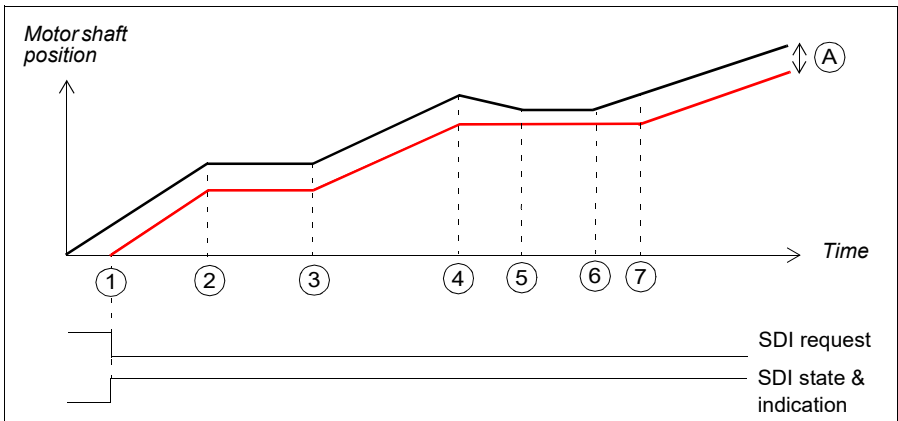

A SDI tolerance limit degree (parameter [SDI.14](#)): The motor shaft cannot move to the forbidden direction more than defined with this parameter.

— SDI monitoring limit

Step	Description
1	The SDI positive request is received (for example, from the I/O) and the FSO starts the SDI monitoring. The SDI active indication goes on. The motor rotates to the correct direction (in this case, positive).
2	The motor stops.
3	The motor starts to rotate again (into the positive direction).
4	The rotation direction of the motor changes to the forbidden (negative) direction. The FSO locks the SDI tolerance limit degree (A) into its current position.
5	The motor stops before the SDI tolerance limit (A) is reached.
6	The motor starts to rotate again (into the positive direction).
7	The motor continues to rotate to the correct direction and the SDI tolerance limit degree (A) is update to its original value.

SDI with time monitoring

This applies when the motor rotates into the forbidden direction when the SDI function is activated and the time monitoring method is used. The SDI positive function is used as an example.

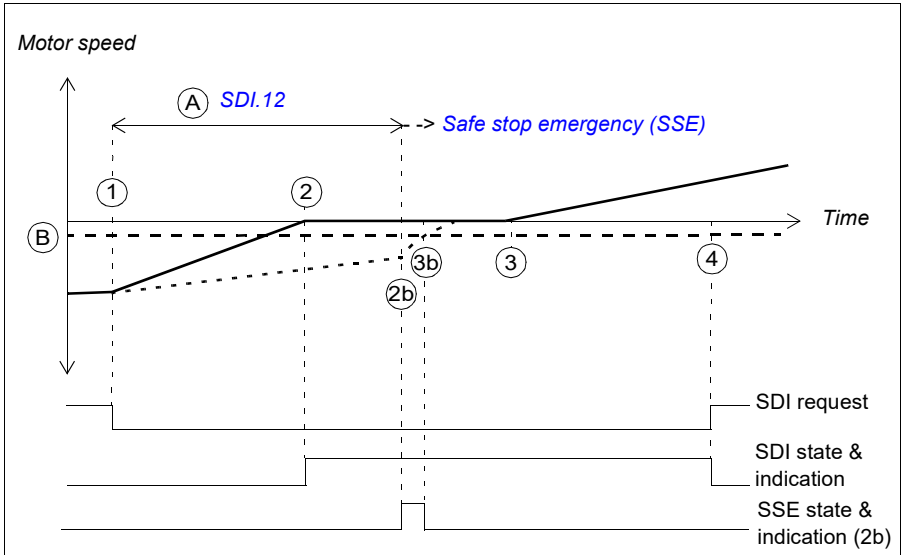

- A SDI delay (parameter [SDI.12](#)): Delay for forcing to start the SDI monitoring.
- B Zero speed with encoder (parameter [FSOGEN.52](#)): Speed limit to define the motor as stopped. The safety function is completed and the SSE completed indication (parameter [SSE.22](#)) goes on. The STO acknowledgment becomes allowed.

Step	Description
1	The SDI positive request is received (for example, from the I/O). The motor rotates into the forbidden direction (in this case, negative). The drive starts to decelerate the motor speed to zero speed. The drive (parameter 23.13 or 23.15) defines the deceleration ramp. The FSO module starts a counter for time A. The SDI active indication is off.
2	The motor speed reaches zero and the motor stops. The FSO starts the SDI monitoring according to the SDI tolerance limit degree (not shown in this figure, see section SDI with correct rotation direction on page 187). The SDI active indication goes on.
2b	The FSO starts the SDI monitoring at the latest here, that is, after the SDI delay (A) has elapsed. Note: If the rotation direction of the motor is not correct after the SDI delay (A) has elapsed, the FSO module activates the SDI monitoring. If the motor rotates to the forbidden direction more than the SDI tolerance limit degree (parameter SDI.14 , not shown in this figure) allows, the FSO activates the SSE function and the motor coasts to a stop (in this case the SSE function has been configured as "Immediate STO"). See section SDI trip limit hits on page 193.
3	The user gives a new speed reference. The motor starts to rotate into the correct (positive) direction.
3b	Zero speed limit (B) reached. If the SSE function was activated at 2b, the STO acknowledgement becomes allowed and the FSO starts the SDI monitoring.
4	The SDI request is removed and the FSO stops the SDI monitoring. The SDI function is acknowledged (automatic SDI acknowledgement) and the SDI active indication goes off.

SDI with ramp monitoring

This applies when the motor rotates into the forbidden direction when the SDI is activated and the ramp monitoring method is used. The SDI positive function is used as an example.

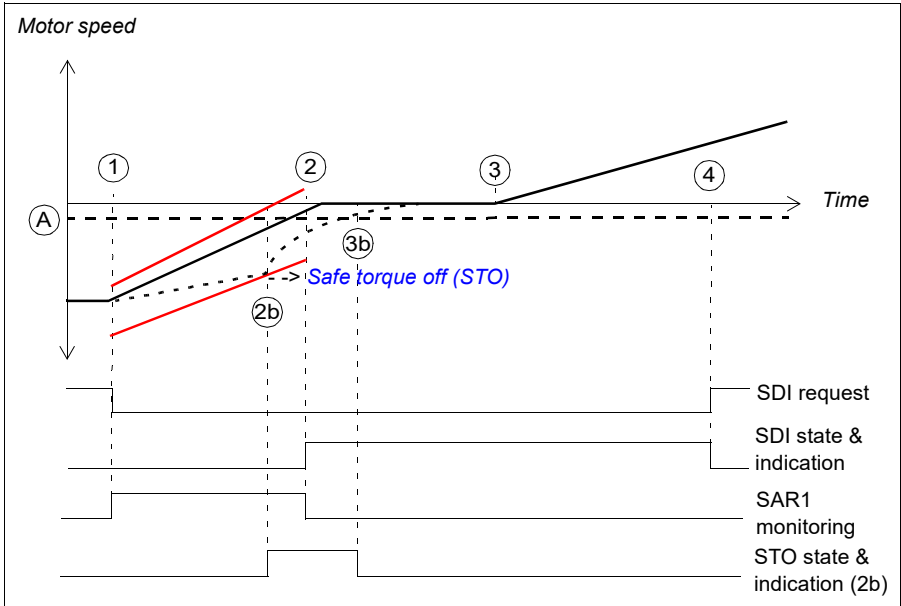

- A Zero speed with encoder (parameter [FSOGEN.52](#)): Speed limit to define the motor as stopped. The safety function is completed and the STO completed indication (parameter [STO.22](#)) goes on. The STO acknowledgment becomes allowed.

— Ramp monitoring limits

Step	Description
1	<p>The SDI positive request is received (for example, from the I/O). The motor rotates into the forbidden direction (in this case, negative). The drive starts to decelerate the motor speed to zero speed. SAR1 parameter 200.112 defines the deceleration ramp. The FSO module starts the ramp monitoring (SAR1 parameters SARx.21, SARx.22). The SDI active indication is off.</p> <p>Note: If parameter 200.112 has value 0, the drive (parameter 23.23) defines the ramp.</p>
2	<p>The motor speed reaches zero and the motor stops. The FSO stops the ramp monitoring and starts the SDI monitoring according to the SDI tolerance limit degree (not shown in this figure, see section SDI with correct rotation direction on page 187). The SDI active indication goes on.</p>
2b	<p>If the deceleration of the motor does not follow the ramp monitoring limits, the FSO module activates the STO function and the motor coasts to a stop. The STO indication goes on (parameter STO.21). See section Safe torque off (STO) on page 68 for more information on how to configure the STO function.</p>
3	<p>The user gives a new speed reference. The motor starts to rotate into the correct (positive) direction.</p>
3b	<p>Zero speed limit (A) reached. If the STO function was activated at 2b, the STO acknowledgement becomes allowed and the FSO starts the SDI monitoring.</p>
4	<p>The SDI request is removed and the FSO stops the SDI monitoring. The SDI function is acknowledged (automatic SDI acknowledgement) and the SDI active indication goes off.</p>

SDI trip limit hits

This applies to SDI trip limit hit situations, that is, when the motor rotates too much to the forbidden direction while the SDI monitoring is on. The SDI positive function is used as an example.

Note: This diagram shows the position of the motor shaft (not the motor speed).

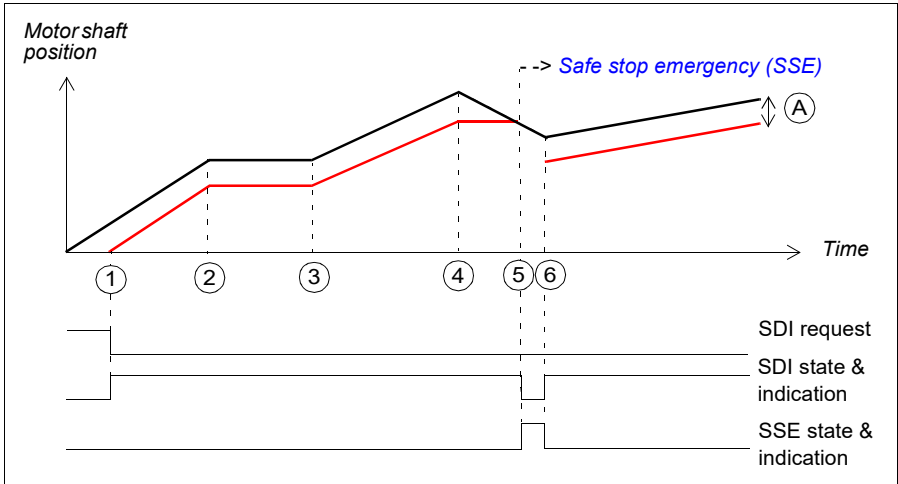

A SDI tolerance limit degree (parameter *SDI.14*): The motor shaft cannot move to the forbidden direction more than defined with this parameter.

— SDI monitoring limit

Step	Description
1	The SDI positive request is received (for example, from the I/O) and the FSO starts the SDI monitoring. The SDI active indication goes on. The motor rotates to the correct direction (in this case, positive).
2	The motor stops.
3	The motor starts to rotate again (into the positive direction).
4	The rotation direction of the motor changes to the forbidden (negative) direction. The FSO locks the SDI tolerance limit (A) into its current position.
5	The SDI tolerance limit (A) is reached. The FSO stops the SDI monitoring and activates the SSE function and the motor coasts to a stop. The SDI indication goes off. The SSE indication goes on. See section Safe stop emergency (SSE) on page 107 for more information on how to configure the SSE function.
6	The motor has stopped. The SSE function is completed and the FSO starts the SDI monitoring. The SDI active indication goes on and the SSE indication goes off. When the motor starts to rotate again (into the correct direction), the SDI monitoring continues with the original SDI tolerance limit (A).

Priorities between safety functions

When several safety functions are active at the same time, these priorities apply:

1. the STO function overrides the SSE and SS1 functions
2. the SSE function overrides the SS1 function.

The overriding function will also override the indications of the low priority functions, eg, by switching off the outputs of the safety functions with lower priority.

The POUS function is independent of other safety functions. If you activate the POUS function when another safety function is active (for example, during a deceleration ramp), it can disturb the performance of the other safety function. ABB recommends that you do not activate the POUS function when the motor is running.

Example: The SS1 function uses SAR1 parameters to define the stop ramp. In some situations (for example, with PROFIsafe-related faults or trip limit hits), the FSO module activates the Safe stop emergency (SSE) function. When the SSE function has been configured as “Emergency ramp”, it uses SAR0 parameters to define the stop ramp. If the FSO module activates the SSE function while the SS1 function is active, the SSE function overrides the SS1 function. Therefore, SAR0 parameters are used instead of SAR1 parameters to define the stop ramp.

When a safety function overrides another safety function, this does not remove the request of the overridden safety function. Therefore, the overridden safety function restarts after the other safety function has been completed and acknowledged.

Dependencies between safety functions

The figure below shows how different safety functions of the FSO module are related to each other and the drive STO function.

1. Zero speed limit reached: The SS1 and SSE (with emergency ramp) functions activate the drive STO function (that is, open the drive STO circuit) when the motor speed reaches the user-defined zero speed limit.
2. Trip limit hit: The SMS and SLS functions activate the SSE function when the motor speed reaches a user-defined trip limit. The SDI function activates the SSE function when motor rotation reaches the user-defined SDI tolerance limit.
3. Monitoring limit hit: The SS1, SSE (with emergency ramp), SLS and SDI functions (with ramp monitoring) activate the STO function of the FSO module when the motor speed reaches a monitoring limit.

The STO, SSE with immediate STO and POUS functions activate the drive STO function, that is, open the drive STO circuit.

The POUS function activates the drive STO independently of the stopping functions of the FSO module.

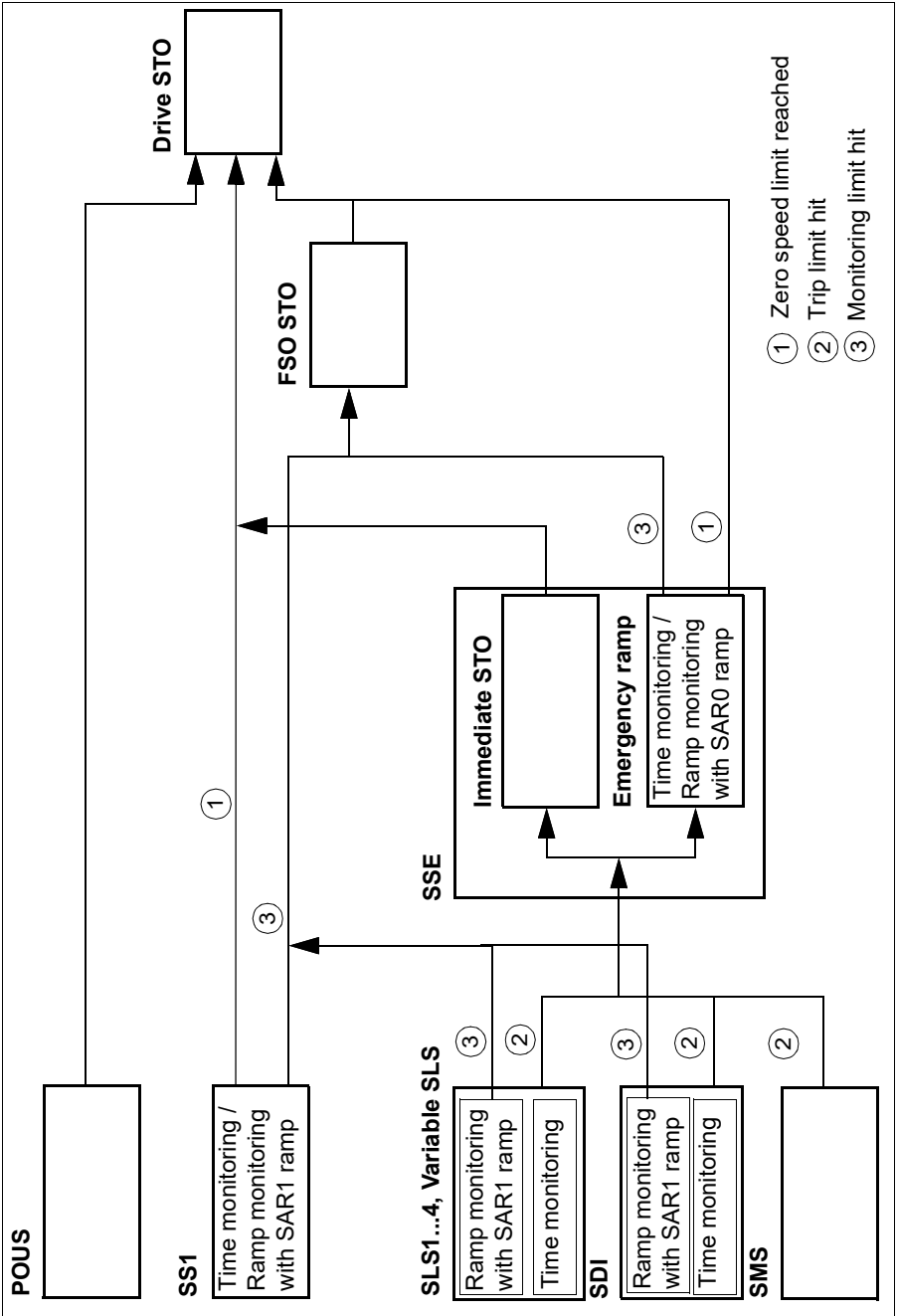

6

PROFIsafe

Contents of this chapter

This chapter describes the safety system when the FSO module is connected to a safety PLC through a fieldbus adapter module using the PROFIsafe profile of PROFINET. It describes the FSO module states and transitions and the contents of the PROFIsafe messages. The chapter also includes installation instructions, configuration instructions for the ABB AC500-S Safety PLC and Siemens SIMATIC Fail-safe S7 PLC and fault tracing tips.

Introduction

When the drive is controlled from a safety PLC, the reliability of the fieldbus communication must be secured. This can be done with the PROFIsafe technology. The PROFIsafe technology includes several safety measures to minimize the effect of various transmission errors that can occur when messages are transferred in a complex network.

PROFIsafe is an application layer (protocol) that describes the safety communication between fail-safe devices. It is an additional layer on top of the standard PROFIBUS and PROFINET protocols.

There are two versions of the PROFIsafe protocol:

- V1 can only be used with PROFIBUS
- V2 can be used with PROFIBUS and PROFINET.

The FSO module supports PROFIsafe protocol version V2.4 with PROFINET.

The PROFIsafe protocol can be used for safety applications up to SIL 3 according to IEC 61508 / IEC 62061, or up to PL e, cat. 4 according to EN ISO 13849-1.

It is possible to use the shared device feature together with an FPNO-21 module. For further information, see FPNO-21 PROFINET adapter module user's manual (3AXD50000158614 [English]).

For more information on PROFIsafe and PROFINET, see www.profibus.com.

System description

■ Required components

- FSO-21 safety functions module
- ACS880 Primary control program: version 2.12 or later / DCS880 Firmware version 2.07 or later
- FB module: FPNO-21 PROFINET fieldbus adapter module (version 1.00 or later) or FENA-21 Ethernet adapter module (version 3.05 or later)
- compatible safety PLC system, for example, ABB AC500-S Safety PLC or Siemens SIMATIC Fail-safe S7 PLC

■ Tools

- Drive Composer pro: version 1.7 or later
 - For ABB PLCs: Automation builder: 1.0 or later (includes PS501 Control Builder Plus version 2.3.0), safety license PS501-S
 - For Siemens PLCs: SIMATIC Step 7 V5.5 + S7 Distributed Safety V5.4 and SIMATIC Step 7 V 11 (TIA Portal) + Step 7 Safety Advanced V 13
-

System overview

This figure shows an overview of a safety PLC that is connected to the ACS880 drive via the PROFIsafe communication bus.

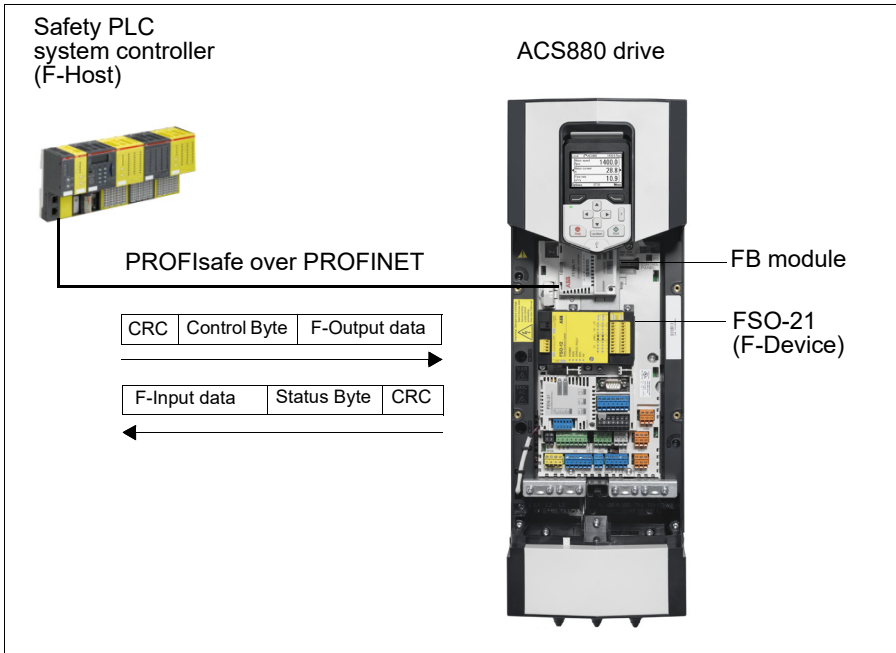

The FSO-21 safety functions module and the FB module are installed on the ACS880 drive. The safety PLC is connected to the FB module, which communicates with the FSO module. The safety PLC activates safety functions via the PROFIsafe communication bus. The user can also activate safety functions from an I/O device (for example, an emergency stop button) which is connected to the FSO module.

The PROFIsafe protocol secures the whole path from the location where a safety signal originates to the location where it is processed and vice versa.

The safety PLC sends PROFIsafe messages (frames) to the FSO module through the FB module which extracts the frame from the PROFINET communication. The FSO module reads and interprets the PROFIsafe messages and performs the required actions. The FSO module sends PROFIsafe messages back to the FB module which transmits them to the safety PLC.

The term PROFIsafe F-Output data refers to the application-specific user data in the frames that are transmitted to the FSO module (F-Device) from the safety PLC (F-Host). The term PROFIsafe F-Input data refers to the application-specific user data in the frames that are transmitted from the FSO module to the safety PLC. For a

detailed description of the PROFIsafe message format, see section [PROFIsafe message format](#) on page 202.

F-Parameters are PROFIsafe parameters that all PROFIsafe devices support.

F-Parameters are sent from the F-Host (safety PLC) to the F-Device (FSO module) when the PROFIsafe connection is created. They contain the PROFIsafe addresses and the watchdog time for the PROFIsafe connection.

Note: ABB recommends that you use only PROFINET compatible Ethernet switches and cables in the PROFIsafe communication bus.

Remote I/O control

You can control the FSO module outputs and read input information also from the safety PLC. A request to activate or deactivate an output is sent from the safety PLC (PROFIsafe controller) to the FSO module in a PROFIsafe message. See section [FSO PROFIsafe profiles](#) on page 203.

Only FSO outputs that are not configured for any control use (for example, to control an indication lamp or a brake) can be activated from the safety PLC. If the safety PLC tries to activate an FSO output that is configured for control use, the FSO module rejects the request, activates the SSE function and goes into the Fail-safe mode (see section [FSO module modes and states](#) on page 214). To exit the Fail-safe mode, reboot the FSO as described in [Internal fault](#) on page 507.

FSO module passivation

If the FSO module or the safety PLC detects an error in the fieldbus communication, the FSO module is passivated. The status of the FSO outputs that are not configured for any control use (for example, to control an indication lamp or a brake) are set to “low”. The FSO module activates the SSE function, goes into the Safe state and generates an event. The user can select the event type (warning, fault or event) with parameter [SBUSGEN.10 STO indication passivation](#).

After the cause of the passivation has been detected, the SSE function must be acknowledged before the communication continues. The status of the safety functions and FSO outputs are set according to the PROFIsafe message that was received before the passivation.

PROFIsafe description

■ PROFIsafe message format

The FSO module supports only the PROFIsafe short frame format. The short frame supports a maximum of 12 octets of user data. The frame also includes a CRC (3 octets) and one Status/Control Byte octet. Therefore, the maximum frame size of the message is 16 octets.

Data	F-Input / F-Output user data	Status / Control Byte	CRC2
Size (octets)	Max. 12	1	3

Control Byte and CRC2 bit order

PROFIsafe messages sent from the safety PLC to the FSO module include the F-Output user data, the Control Byte and CRC2.

This table shows the bit order of the Control Byte and CRC2.

N_o is the length of F-Output user data.

Octet	Bit	Name	Description
Control Byte			
N_o	7	Reserved	The value is ignored.
	6	Reserved	The value is ignored.
	5	Toggle_h	Toggle bit
	4	Activate_FV	Fail-safe values (FV) to be activated
	3	Use_TO2	Use F_WD_Time_2 (secondary watchdog). Not in use. The value is ignored.
	2	R_cons_nr	Reset Vconsnr_d
	1	OA_Req	Operator acknowledgement requested
	0	iPar_EN	Parameter assignment deblocked. Not in use. The value is ignored.
CRC2			
N_o+1	7	CRC bit 23	Octet 3 (MSB) of 24 bit CRC
	...		
	0	CRC bit 16	
N_o+2	7	CRC bit 15	Octet 2 of 24 bit CRC
	...		
	0	CRC bit 8	
N_o+3	7	CRC bit 7	Octet 1 (LSB) of 24 bit CRC
	...		
	0	CRC Bit 0	

Status Byte and CRC2 bit order

PROFIsafe messages sent from the FSO module to the safety PLC include the F-Input user data, the Status Byte and CRC2.

This table shows the bit order of the Status Byte and CRC2.

N_i is the length of F-Input user data.

Octet	Bit	Name	Description
Status Byte			
N_i	7	Reserved	The value is always 0. Must be ignored by the F-Host.
	6	cons_nr_R	Vconsnr_d has been reset.
	5	Toggle_d	Toggle bit
	4	FV_activated	Fail-safe values (FV) activated.
	3	WD_timeout	Communication fault: Watchdog timeout
	2	CE_CRC	Communication fault: CRC error
	1	Device_Fault	Failure exists in the F-Device.
	0	iPar_OK	F-Device has new iParameter values assigned. Not in use. The value is always 0.
CRC2			
N_i+1	7	CRC bit 23	Octet 3 (MSB) of 24 bit CRC
	...		
	0	CRC bit 16	
N_i+2	7	CRC bit 15	Octet 2 of 24 bit CRC
	...		
	0	CRC bit 8	
N_i+3	7	CRC bit 7	Octet 1 (LSB) of 24 bit CRC
	...		
	0	CRC bit 0	

■ FSO PROFIsafe profiles

The content of the F-Input and F-Output user data is configured with FSO specific PROFIsafe profiles. The FSO-21 module supports the ABB_PS1 and ABB_PS2 profiles.

The ABB_PS1 profile provides the functionality to control and monitor the safety functions, the SLS limits, the safe speed value and the states of the FSO I/O. In addition to the functionality in the ABB_PS1 profile, the ABB_PS2 profile includes the safe position data. The ABB_PS2 profile requires that an encoder is used in the safety system.

ABB_PS1 profile F-Output user data

This table shows the bit order of the F-Output data, which is included in the PROFIsafe message sent to the FSO module from the safety PLC. For all the bits in the F-Output data, one (1) means active and zero (0) non-active.

Type	Octet	Bit	Name	Description
Unsigned16 (used as bits)	0	0	SLS2_request	SLS2 (Safely-limited speed) activation requested by the controller.
		1	SLS1_request	SLS1 (Safely-limited speed) activation requested by the controller.
		2	Reserved [*])	Must not be used (must be 0).
		3	Reserved [*])	Must not be used (must be 0).
		4	SS1_request	SS1 (Safe stop 1) activation requested by the controller.
		5	SSE_request	SSE (Safe stop emergency) activation requested by the controller.
		6	POUS_request	POUS (Prevention of unexpected start-up) activation request by the controller.
		7	STO_request	STO (Safe torque off) activation requested by the controller.
Unsigned16 (used as bits)	1	0	SDI_N_activate	SDI_N (Safe direction) activation requested by the controller.
		1	SDI_P_activate	SDI_P (Safe direction) activation requested by the controller.
		2	Reserved [*])	Must not be used (must be 0).
		3	Reserved [*])	Must not be used (must be 0).
		4	Reserved [*])	Must not be used (must be 0).
		5	Reserved [*])	Must not be used (must be 0).
		6	SLS4_request	SLS4 (Safely-limited speed) activation requested by the controller.
		7	SLS3_request	SLS3 (Safely-limited speed) activation requested by the controller.

Type	Octet	Bit	Name	Description
Unsigned16 (used as bits)	2	0	Variable_SLS_request	Variable SLS (Safely-limited speed) activation requested by the controller and the Variable SLS limit is valid.
		1	Reserved ^{*)}	Must not be used (must be 0).
		2	SF_end_ack	Safety function ending acknowledgement = 1, no acknowledgement = 0.
		3	Reserved ^{*)}	Must not be used (must be 0).
		4	SSM4_activate	SSM4 (Safe speed monitor) activation requested by the controller.
		5	SSM3_activate	SSM3 (Safe speed monitor) activation requested by the controller.
		6	SSM2_activate	SSM2 (Safe speed monitor) activation requested by the controller.
Unsigned16 (used as bits)	3	7	SSM1_activate	SSM1 (Safe speed monitor) activation requested by the controller.
		0	Safe_output_X114_9_ctrl	State of the safe output X114:9 (see section Remote I/O control on page 201). 1 = 24 V, 0 = 0 V.
		1	Safe_output_X114_8_ctrl	State of the safe output X114:8 (see section Remote I/O control on page 201). 1 = 24 V, 0 = 0 V.
		2	Safe_output_X114_7_ctrl	State of the safe output X114:7 (see section Remote I/O control on page 201). 1 = 24 V, 0 = 0 V.
		3	Safe_output_X113_9_ctrl	State of the safe output X113:9 (see section Remote I/O control on page 201). 1 = 24 V, 0 = 0 V.
		4	Safe_output_X113_8_ctrl	State of the safe output X113:8 (see section Remote I/O control on page 201). 1 = 24 V, 0 = 0 V.
		5	Safe_output_x113_7_ctrl	State of the safe output X113:7 (see section Remote I/O control on page 201). 1 = 24 V, 0 = 0 V.
		6	Negative_Scaling	Selects whether Variable SLS limit is scaled for negative direction. 0 = Limit scaled, 1 = Limit not scaled (100%).
Integer16	4	7	Positive_Scaling	Selects whether Variable SLS limit is scaled for positive direction. 0 = Limit scaled, 1 = Limit not scaled (100%).
			Variable_SLS_limit_MSB	Safely-limited speed relative limit (MSB) [0.01%]
Integer16	5		Variable_SLS_limit_LSB	Safely-limited speed relative limit (LSB) [0.01%]

^{*)} If the PROFIsafe message includes a safety function request which is not supported or if the safety function has not been configured, the FSO module activates the SSE function and generates an FSO configuration fault (see chapter [Fault tracing](#)).

ABB_PS1 profile F-Input user data

This table shows the bit order of the F-Input user data, which is included in the PROFIsafe message sent from the FSO module to the safety PLC. For all the bits in the F-Input data, one (1) means active and zero (0) non-active.

Note: In the Fail-safe and Configuration states, all the bits in the PROFIsafe message are set to “0”. In these cases, you can read the FSO state from:

- Siemens PLC: bits QBAD and PASS_OUT in the PROFIsafe data block
- ABB PLC: bit Device_Fault in the PROFIsafe data structure.

See also section [FSO module modes and states](#) on page 214.

Type	Octet	Bit	Name	Description
Unsigned16 (used as bits)	0	0	SLS2_active	SLS2 (Safely-limited speed) is active. Active when the SLS2 function is active and the motor speed is below the SLS2 limit (that is, when the SLS2 monitoring is on).
		1	SLS1_active	SLS1 (Safely-limited speed) is active. Active when the SLS1 function is active and the motor speed is below the SLS1 limit (that is, when the SLS1 monitoring is on).
		2	Reserved ^{*)}	The value is 0. Must be ignored by the F-Host.
		3	Reserved ^{*)}	The value is 0. Must be ignored by the F-Host.
		4	SS1_active	SS1 (Safe stop 1) is function active.
		5	SSE_active	SSE (Safe stop emergency) function is active.
		6	SBC_active	SBC (Safe brake control) function is active.
		7	STO_active	STO (Safe torque off) function is active.
Unsigned16 (used as bits)	1	0	Reserved ^{*)}	The value is 0. Must be ignored by the F-Host.
		1	Reserved ^{*)}	The value is 0. Must be ignored by the F-Host.
		2	Reserved ^{*)}	The value is 0. Must be ignored by the F-Host.
		3	Reserved ^{*)}	The value is 0. Must be ignored by the F-Host.
		4	SAR1_active	SAR1 (Safe acceleration range) is active.
		5	SAR0_active	SAR0 (Safe acceleration range) is active.
		6	SLS4_active	SLS4 (Safely-limited speed) is active. Active when the SLS4 function is active and the motor speed is below the SLS4 limit (that is, when the SLS4 monitoring is on).
		7	SLS3_active	SLS3 (Safely-limited speed) is active. Active when the SLS3 function is active and the motor speed is below the SLS3 limit (that is, when the SLS3 monitoring is on).

Type	Octet	Bit	Name	Description
Unsigned16 (used as bits)	2	0	Speed_feedback_type	Active speed feedback 0=Estimate is active 1=Encoder is active Note: This value should only be used for octet 5 bit 3 Speed_Pos_value_valid interpretation, that is, to determine if the position value is valid or not (octet 8 and 9).
		1	SMS_active	SMS (Safe maximum speed) function is active.
		2	SSM4_active	SSM4 (Safe speed monitor) function is active and the motor speed is within the SSM4 limits.
		3	SSM3_active	SSM3 (Safe speed monitor) function is active and the motor speed is within the SSM3 limits.
		4	SSM2_active	SSM2 (Safe speed monitor) function is active and the motor speed is within the SSM2 limits.
		5	SSM1_active	SSM1 (Safe speed monitor) function is active and the motor speed is within the SSM1 limits.
		6	SDI_N_active	SDI_N (Safe direction) is active.
Unsigned16 (used as bits)	3	7	SDI_P_active	SDI_P (Safe direction) is active.
		0	Safe_input_X114_4	State of the safe input X114:4.
		1	Safe_input_X114_3	State of the safe input X114:3.
		2	Safe_input_X114_2	State of the safe input X114:2.
		3	Safe_input_X114_1	State of the safe input X114:1.
		4	Safe_input_X113_4	State of the safe input X113:4.
		5	Safe_input_X113_3	State of the safe input X113:3.
		6	Safe_input_X113_2	State of the safe input X113:2.
Unsigned16 (used as bits)	4	7	Safe_input_X113_1	State of the safe input X113:1.
		0	Variable_SLS_active	Variable SLS (Safely-limited speed) is active. Active when the Variable SLS function is active and the motor speed is below the Variable SLS limit (that is, when the Variable SLS monitoring is on).
		1	POUS_active	POUS (Prevention of unexpected start-up) function is active.
		2	Safe_output_X114_9	State of the safe output X114:9.
		3	Safe_output_X114_8	State of the safe output X114:8.
		4	Safe_output_X114_7	State of the safe output X114:7.
		5	Safe_output_X113_9	State of the safe output X113:9.
		6	Safe_output_X113_8	State of the safe output X113:8.
7	Safe_output_X113_7	State of the safe output X113:7.		

Type	Octet	Bit	Name	Description															
Unsig ned16 (used as bits)	5	0	SF_end_ack_req	Safety function ending acknowledgement requested = 1, no acknowledgement requested = 0. Acknowledgement can be done via PROFIsafe. Note: These values are indicative only and shall not be used for safety-related decisions about safety function states (there are other ways to safely determine the state of a function, for example, using SS1 to check octet 0 bit 4 and then octet 5 bit 4: if safe state, then SS1 is completed).															
		1	SF_end_ack_req_lo cal	Local safety function ending acknowledgement requested = 1, no acknowledgement requested = 0. Acknowledgement can only be done locally via the FSO I/O if SF_end_ack_req is 0. Note: These values are indicative only and shall not be used for safety-related decisions about safety function states (there are other ways to safely determine the state of a function, for example, using SS1 to check octet 0 bit 4 and then octet 5 bit 4: if safe state, then SS1 is completed).															
		2	STO_control_active	The drive STO circuit is open. Note: The motor may still be rotating.															
		3	Speed_value_valid	Is the speed value valid (= 1) or not (= 0). The speed value is defined in octets 6 and 7. Note: Octet 2 bit 0 indicates the speed source and octet 5 bit 3 indicates the validity of the indicated speed source.															
		4	FSO_state	Safe state = 1 Operational state = 0															
		5	FSO_mode.0																
		6	FSO_mode.1	<table border="1"> <thead> <tr> <th>FSO operating mode</th> <th>FSO_mode.1</th> <th>FSO_mode.0</th> </tr> </thead> <tbody> <tr> <td>Start-up</td> <td>0</td> <td>0</td> </tr> <tr> <td>Running</td> <td>0</td> <td>1</td> </tr> <tr> <td>Fail-safe</td> <td>1</td> <td>0</td> </tr> <tr> <td>Configuration</td> <td>1</td> <td>1</td> </tr> </tbody> </table>	FSO operating mode	FSO_mode.1	FSO_mode.0	Start-up	0	0	Running	0	1	Fail-safe	1	0	Configuration	1	1
		FSO operating mode	FSO_mode.1	FSO_mode.0															
Start-up	0	0																	
Running	0	1																	
Fail-safe	1	0																	
Configuration	1	1																	
7	Modulating	The drive is modulating = 1 It is not known if the drive is modulating or not = 0  WARNING! The only safe way to make sure that a drive is not modulating is to activate drive STO. Drive STO can be activated, eg, with FSO STO or POUS function.																	

Type	Octet	Bit	Name	Description
Integer16	6		Safe_speed_MSB	The current motor speed value from FSO (MSB).
Integer16	7		Safe_speed_LSB	The current motor speed value from FSO (LSB).

^{*)} The safety PLC must ignore the value of the reserved bits. This ensures the compatibility with future versions of the PROFIsafe profile where the reserved bits may be used.

Note: The states of all FSO inputs and outputs are shown in the PROFIsafe message. These states also show the states of SBC outputs and feedback inputs.

ABB_PS2 profile F-Output user data

This table shows the bit order of the F-Output data, which is included in the PROFIsafe message sent to the FSO module from the safety PLC. For all the bits in the F-Output data, one (1) means active and zero (0) non-active.

Type	Octet	Bit	Name	Description
Unsigned16 (used as bits)	0	0	SLS2_request	SLS2 (Safely-limited speed) activation requested by the controller.
		1	SLS1_request	SLS1 (Safely-limited speed) activation requested by the controller.
		2	Reserved ^{*)}	Must not be used (must be 0).
		3	Reserved ^{*)}	Must not be used (must be 0).
		4	SS1_request	SS1 (Safe stop 1) activation requested by the controller.
		5	SSE_request	SSE (Safe stop emergency) activation requested by the controller.
		6	POUS_request	POUS (Prevention of unexpected start-up) activation request by the controller.
		7	STO_request	STO (Safe torque off) activation requested by the controller.
Unsigned16 (used as bits)	1	0	SDI_N_activate	SDI_N (Safe direction) activation requested by the controller.
		1	SDI_P_activate	SDI_P (Safe direction) activation requested by the controller.
		2	Reserved ^{*)}	Must not be used (must be 0).
		3	Reserved ^{*)}	Must not be used (must be 0).
		4	Reserved ^{*)}	Must not be used (must be 0).
		5	Reserved ^{*)}	Must not be used (must be 0).
		6	SLS4_request	SLS4 (Safely-limited speed) activation requested by the controller.
		7	SLS3_request	SLS3 (Safely-limited speed) activation requested by the controller.

Type	Octet	Bit	Name	Description
Unsigned16 (used as bits)	2	0	Variable_SLS_request	Variable SLS (Safely-limited speed) activation requested by the controller and Variable SLS limit is valid.
		1	Reserved ^{*)}	Must not be used (must be 0).
		2	SF_end_ack	Safety function ending acknowledgement = 1, no acknowledgement = 0.
		3	Reserved ^{*)}	Must not be used (must be 0).
		4	SSM4_activate	SSM4 (Safe speed monitor) activation requested by the controller.
		5	SSM3_activate	SSM3 (Safe speed monitor) activation requested by the controller.
		6	SSM2_activate	SSM2 (Safe speed monitor) activation requested by the controller.
Unsigned16 (used as bits)	3	0	Safe_output_X114_9_ctrl	State of the safe output X114:9 (see section Remote I/O control on page 201). 1 = 24 V, 0 = 0 V.
		1	Safe_output_X114_8_ctrl	State of the safe output X114:8 (see section Remote I/O control on page 201). 1 = 24 V, 0 = 0 V.
		2	Safe_output_X114_7_ctrl	State of the safe output X114:7 (see section Remote I/O control on page 201). 1 = 24 V, 0 = 0 V.
		3	Safe_output_X113_9_ctrl	State of the safe output X113:9 (see section Remote I/O control on page 201). 1 = 24 V, 0 = 0 V.
		4	Safe_output_X113_8_ctrl	State of the safe output X113:8 (see section Remote I/O control on page 201). 1 = 24 V, 0 = 0 V.
		5	Safe_output_x113_7_ctrl	State of the safe output X113:7 (see section Remote I/O control on page 201). 1 = 24 V, 0 = 0 V.
		6	Negative_Scaling	Selects whether Variable SLS limit is scaled for negative direction. 0 = Limit scaled, 1 = Limit not scaled (100%).
		7	Positive_Scaling	Selects whether Variable SLS limit is scaled for positive direction. 0 = Limit scaled, 1 = Limit not scaled (100%).
Integer16	4		Variable_SLS_limit_MSB	Safely-limited speed relative limit (MSB) [0.01%]
Integer16	5		Variable_SLS_limit_LSB	Safely-limited speed relative limit (LSB) [0.01%]

^{*)} If the PROFIsafe message includes a safety function request which is not supported or if the safety function has not been configured, the FSO module activates the SSE function and generates an FSO configuration fault (see chapter [Fault tracing](#)).

ABB_PS2 profile F-Input user data

This table shows the bit order of the F-Input user data, which is included in the PROFIsafe message sent from the FSO module to the safety PLC. For all the bits in the F-Input data, one (1) means active and zero (0) non-active.

Note: In the Fail-safe and Configuration states, all the bits in the PROFIsafe message are set to “0”. In these cases, you can read the FSO state from:

- Siemens PLC: bits QBAD and PASS_OUT in the PROFIsafe data block
- ABB PLC: bit Device_Fault in the PROFIsafe data structure.

See also section [FSO module modes and states](#) on page 214.

Type	Octet	Bit	Name	Description
Unsigned16 (used as bits)	0	0	SLS2_active	SLS2 (Safely-limited speed) is active. Active when the SLS2 function is active and the motor speed is below the SLS2 limit (that is, when the SLS2 monitoring is on).
		1	SLS1_active	SLS1 (Safely-limited speed) is active. Active when the SLS1 function is active and the motor speed is below the SLS1 limit (that is, when the SLS1 monitoring is on).
		2	Reserved [*])	The value is 0. Must be ignored by the F-Host.
		3	Reserved [*])	The value is 0. Must be ignored by the F-Host.
		4	SS1_active	SS1 (Safe stop 1) function is active.
		5	SSE_active	SSE (Safe stop emergency) function is active.
		6	SBC_active	SBC (Safe brake control) function is active.
		7	STO_active	STO (Safe torque off) function is active.
Unsigned16 (used as bits)	1	0	Reserved [*])	The value is 0. Must be ignored by the F-Host.
		1	Reserved [*])	The value is 0. Must be ignored by the F-Host.
		2	Reserved [*])	The value is 0. Must be ignored by the F-Host.
		3	Reserved [*])	The value is 0. Must be ignored by the F-Host.
		4	SAR1_active	SAR1 (Safe acceleration range) is active.
		5	SAR0_active	SAR0 (Safe acceleration range) is active.
		6	SLS4_active	SLS4 (Safely-limited speed) is active. Active when the SLS4 function is active and the motor speed is below the SLS4 limit (that is, when the SLS4 monitoring is on).
		7	SLS3_active	SLS3 (Safely-limited speed) is active. Active when the SLS3 function is active and the motor speed is below the SLS3 limit (that is, when the SLS3 monitoring is on).

Type	Octet	Bit	Name	Description
Unsigned16 (used as bits)	2	0	Speed_feedback_type	Active speed feedback 0=Estimate is active 1=Encoder is active Note: This value should only be used for octet 5 bit 3 Speed_Pos_value_valid interpretation, that is, to determine if the position value is valid or not (octet 8 and 9).
		1	SMS_active	SMS (Safe maximum speed) function is active.
		2	SSM4_active	SSM4 (Safe speed monitor) function is active and the motor speed is within the SSM4 limits.
		3	SSM3_active	SSM3 (Safe speed monitor) function is active and the motor speed is within the SSM3 limits.
		4	SSM2_active	SSM2 (Safe speed monitor) function is active and the motor speed is within the SSM2 limits.
		5	SSM1_active	SSM1 (Safe speed monitor) function is active and the motor speed is within the SSM1 limits.
		6	SDI_N_active	SDI_N (Safe direction) is active.
	7	SDI_P_active	SDI_P (Safe direction) is active.	
Unsigned16 (used as bits)	3	0	Safe_input_X114_4	State of the safe input X114:4.
		1	Safe_input_X114_3	State of the safe input X114:3.
		2	Safe_input_X114_2	State of the safe input X114:2.
		3	Safe_input_X114_1	State of the safe input X114:1.
		4	Safe_input_X113_4	State of the safe input X113:4.
		5	Safe_input_X113_3	State of the safe input X113:3.
		6	Safe_input_X113_2	State of the safe input X113:2.
	7	Safe_input_X113_1	State of the safe input X113:1.	
Unsigned16 (used as bits)	4	0	Variable_SLS_active	Variable SLS (Safely-limited speed) is active. Active when the Variable SLS function is active and the motor speed is below the Variable SLS limit (that is, when the Variable SLS monitoring is on).
		1	POUS_active	POUS (Prevention of unexpected start-up) function is active.
		2	Safe_output_X114_9	State of the safe output X114:9.
		3	Safe_output_X114_8	State of the safe output X114:8.
		4	Safe_output_X114_7	State of the safe output X114:7.
		5	Safe_output_X113_9	State of the safe output X113:9.
		6	Safe_output_X113_8	State of the safe output X113:8.
	7	Safe_output_X113_7	State of the safe output X113:7.	

Type	Octet	Bit	Name	Description															
Unsigned16 (used as bits)	5	0	SF_end_ack_req	Safety function ending acknowledgement requested = 1, no acknowledgement requested = 0. Acknowledgement can be done via PROFIsafe. Note: These values are indicative only and shall not be used for safety-related decisions about safety function states (there are other ways to safely determine the state of a function, for example, using SS1 to check octet 0 bit 4 and then octet 5 bit 4: if safe state, then SS1 is completed).															
		1	SF_end_ack_req_local	Local safety function ending acknowledgement requested = 1, no acknowledgement requested = 0. Acknowledgement can only be done locally via the FSO I/O if SF_end_ack_req is 0. Note: These values are indicative only and shall not be used for safety-related decisions about safety function states (there are other ways to safely determine the state of a function, for example, using SS1 to check octet 0 bit 4 and then octet 5 bit 4: if safe state, then SS1 is completed).															
		2	STO_control_active	The drive STO circuit is open. The motor may still be running.															
		3	Speed_Pos_value_valid	Are the speed and position values valid (= 1) or not (= 0). The speed value is defined in octets 6 and 7. The position value is defined in octets 8 and 9. Note: In case octet 2 bit 0 Speed_feedback_type value is Estimate (= 0), then Position status is invalid as it requires safety encoder to be valid.															
		4	FSO_state	Safe state = 1 Operational state = 0															
		5	FSO_mode.0	<table border="1"> <thead> <tr> <th>FSO operating mode</th> <th>FSO_mode.1</th> <th>FSO_mode.0</th> </tr> </thead> <tbody> <tr> <td>Start-up</td> <td>0</td> <td>0</td> </tr> <tr> <td>Running</td> <td>0</td> <td>1</td> </tr> <tr> <td>Fail-safe</td> <td>1</td> <td>0</td> </tr> <tr> <td>Configuration</td> <td>1</td> <td>1</td> </tr> </tbody> </table>	FSO operating mode	FSO_mode.1	FSO_mode.0	Start-up	0	0	Running	0	1	Fail-safe	1	0	Configuration	1	1
		FSO operating mode	FSO_mode.1		FSO_mode.0														
		Start-up	0		0														
Running	0	1																	
Fail-safe	1	0																	
Configuration	1	1																	
6	FSO_mode.1																		
7	Modulating	The drive is modulating = 1 It is not known if the drive is modulating or not = 0  WARNING! The only safe way to make sure that a drive is not modulating is to activate drive STO. Drive STO can be activated, eg, with FSO STO or POUS function.																	

Type	Octet	Bit	Name	Description
Integer16	6		Safe_speed_MSB	The current motor speed value from the FSO (MSB).
Integer16	7		Safe_speed_LSB	The current motor speed value from the FSO (LSB).
Integer16	8		Safe_position_MSB	Safe position value (MSB).
Integer16	9		Safe_position_LSB	Safe position value (LSB).

³⁾ The safety PLC must ignore the value of the reserved bits. This ensures the compatibility with future versions of the PROFIsafe profile where the reserved bits may be used.

Note: The states of all FSO inputs and outputs are shown in the PROFIsafe message. These states show also the states of SBC outputs and feedback inputs.

■ FSO module modes and states

When the FSO module is connected to a safety PLC via the PROFIsafe communications bus, the FSO module can be in the following modes and states:

- Start-up mode
- Configuration mode
- Fail-safe mode
- RUN states:
 - Operational
 - Safe (User acknowledgement request)
 - Safe (Module passivation)
 - Safe (Module passivation & reintegration)
 - Safe (Module passivation with a command).

The FSO module modes and states are described in the following two figures and tables.

The first figure shows the modes, states and transitions during normal operation. The second figure shows the modes, states and transitions when fatal errors in the FSO module occur or when cycling power of the FSO module.

Note: If PROFIsafe is not configured, see the FSO states described in section [FSO states](#) on page 61 in chapter [Safety functions](#).

Note: If PROFIsafe is configured, the FSO module stays in the Start-up mode until it has received valid F-Parameters from the safety PLC.

State diagrams

Overview of states and transitions in the FSO module during normal operation.

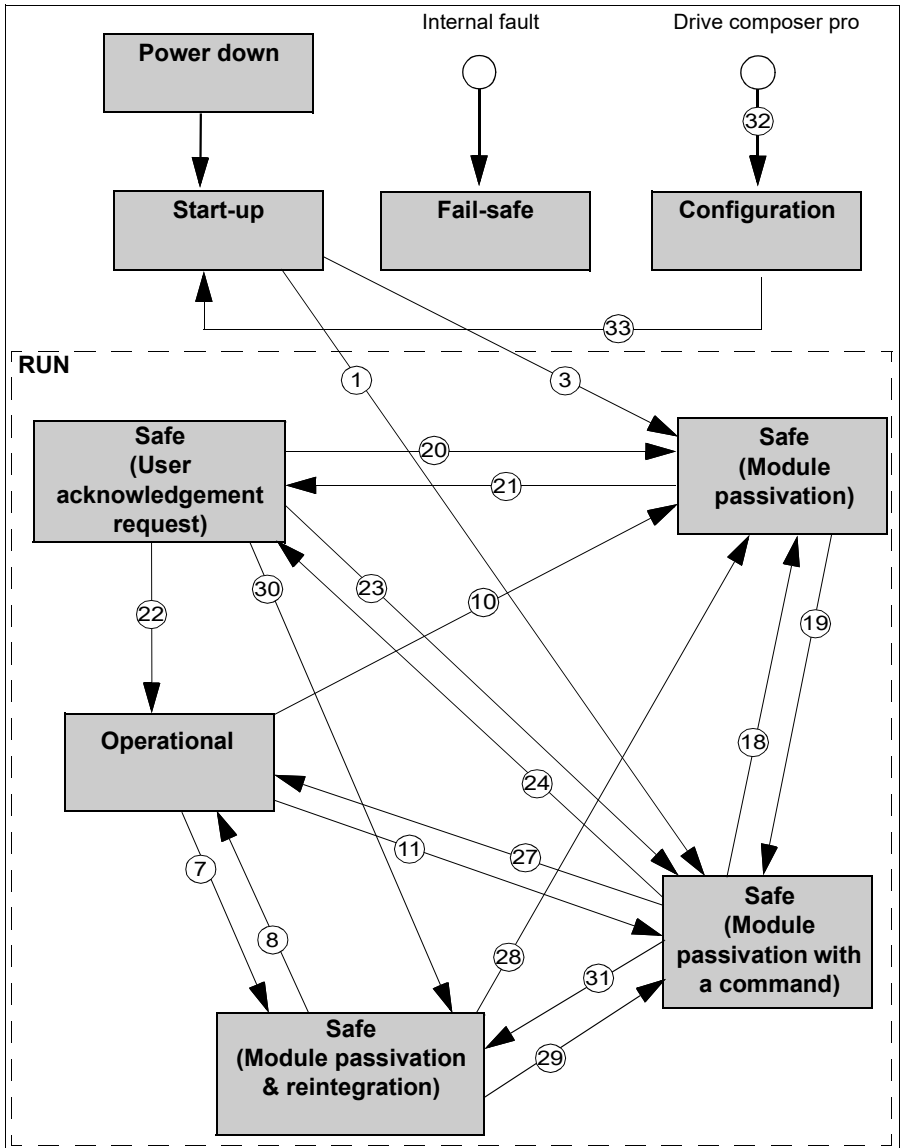

Note: It is possible to go to the Configuration mode from any other state when the drive is not modulating. From the Configuration mode, it is possible to go only to the Start-up mode.

Overview of states and transitions in the FSO module when fatal errors in the FSO module occur or when cycling power of the FSO module.

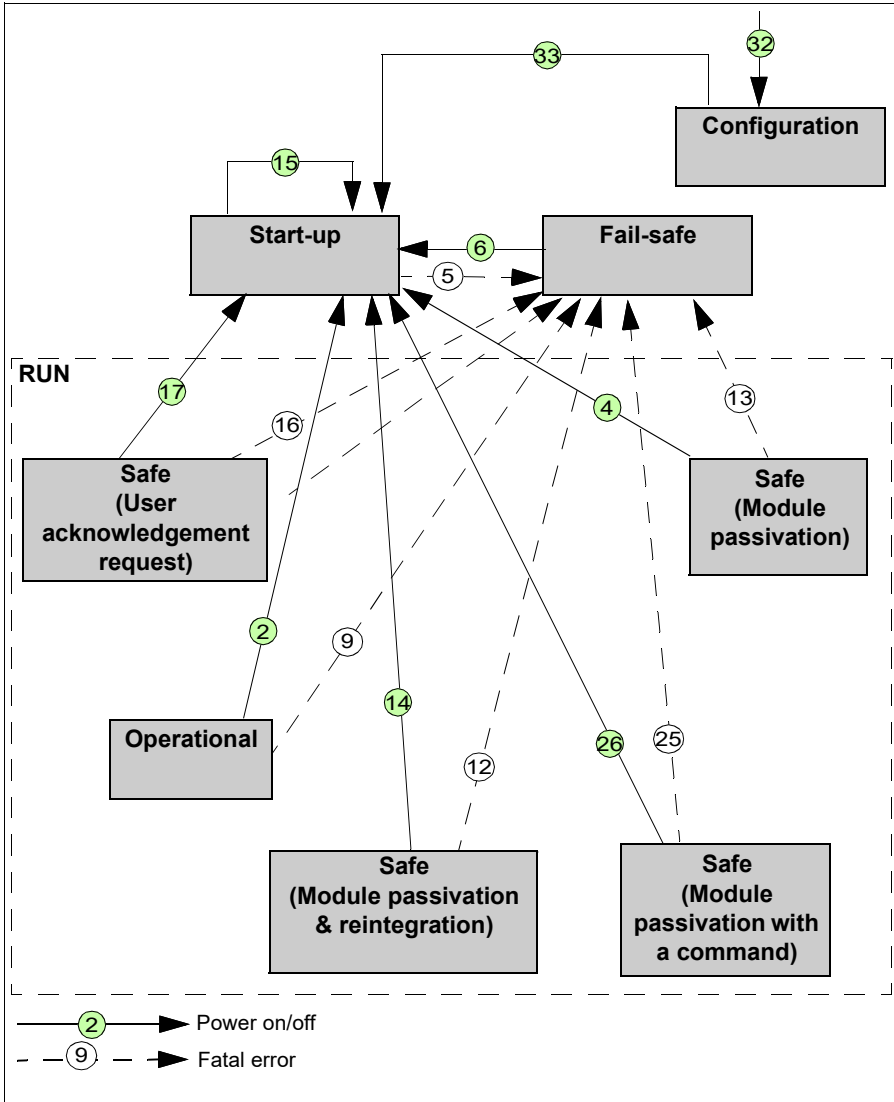

Description of states

This table describes the FSO module states and how the states are shown in the PROFIsafe messages. The Status Byte and the profiles are described in detail in sections [Status Byte and CRC2 bit order](#) on page 203 and [FSO PROFIsafe profiles](#) on page 203.

The table refers to several variables that are available to the programmer of an F-Host program (for example, an AC500-S program in CoDeSys):

OA_Req_S	This variable indicates that the FSO is in the “Safe (User acknowledgement request)” state ready for acknowledgement.
FV_Activated_S	This variable indicates that the FSO is in the Safe state. Fail-safe values (“0”) are set to the I/O channels.
OA_C	This variable indicates that PROFIsafe is running successfully after PROFIsafe communication error(s) have been solved. The FSO is in the “Safe (User acknowledgement request)” state and variable OA_Req_S is set to “1”. Setting OA_C variable to “1” acknowledges that the PROFIsafe communication errors have been solved and it is possible to go to the Operational state.
Device_Fault	This variable is the Device_Fault bit of the PROFIsafe Status Byte. When the value is 1, the FSO is in the Fail-safe mode.

State	Description
Start-up	<p>The FSO module hardware is initialized and internal start-up tests are executed. After a successful parameterization, the PROFIsafe communication is expected to be initiated by the PROFIsafe F-Host. The FSO module remains in this state:</p> <ul style="list-style-type: none"> • if the parameterization failed or is pending • if the PROFIsafe communication is pending. <p>PROFIsafe Status Byte bits in the F-Host for the FSO module:</p> <ul style="list-style-type: none"> • OA_Req_S = 0 • FV_activated_S = 1 • Device_Fault = 0 <p>ABB_PS1 or ABB_PS2 profile bits in the F-Host for the FSO module:</p> <ul style="list-style-type: none"> • FSO_mode.1 = 0 • FSO_mode.0 = 0 • SF_end_ack_req_local = 0 • SF_end_ack_req = 0 • FSO_state = 1

State	Description
Operational	<p>PROFIsafe communication is up and running. The safety application is running without any detected errors.</p> <p>PROFIsafe Status Byte bits in the F-Host for the FSO module:</p> <ul style="list-style-type: none">• OA_Req_S = 0• FV_activated_S = 0• Device_Fault = 0 <p>ABB_PS1 or ABB_PS2 profile bits in the F-Host for the FSO module:</p> <ul style="list-style-type: none">• FSO_mode.1 = 0• FSO_mode.0 = 1• SF_end_ack_req_local = 0• SF_end_ack_req = 0• FSO_state = 0

State	Description
Safe (Module passivation & reintegration)	<p>PROFIsafe communication is up and running. The FSO application is running with detected errors.</p> <p>At least one of the active safety functions has encountered an error. For example, the SLS1 function is active and its speed limits are violated. The drive is stopped using the configured method. In the end, the drive STO is activated.</p> <p>As soon as the STO function has been completed and no errors are detected, reintegration of the FSO module is possible. It depends on the FSO configuration from where the reintegration can be done. All tripped safety functions must be acknowledged to complete the reintegration.</p> <p>SF_end_ack_req_local is set if any of the safety functions can be acknowledged locally via FSO inputs.</p> <p>SF_end_ack_req is set if any of the safety functions can be acknowledged via PROFIsafe frame bit SF_end_ack. A positive edge from "0" to "1" is required to acknowledge the module reintegration.</p> <p>If automatic acknowledgement is configured for the error condition, neither of the status bits is set. The acknowledgement is done automatically.</p> <p>As soon as all errors have been solved and they have been acknowledged, the Operational state is reached.</p> <p>PROFIsafe Status Byte bits in the F-Host for the FSO module:</p> <ul style="list-style-type: none"> • OA_Req_S = 0 • FV_activated_S = 0 • Device_Fault = 0 <p>ABB_PS1 or ABB_PS2 profile bits in the F-Host for the FSO module:</p> <ul style="list-style-type: none"> • FSO_mode.1 = 0 • FSO_mode.0 = 1 • SF_end_ack_req_local = 1, if it is possible to acknowledge any of the tripped safety functions locally via the FSO inputs. SF_end_ack_req_local = 0, otherwise. • SF_end_ack_req = 1, if it is possible to acknowledge any of the tripped safety functions via PROFIsafe. SF_end_ack_req = 0, otherwise. • FSO_state = 1

State	Description
Safe (Module passivation)	<p>The FSO application is running and there has been an error in the PROFIsafe communication.</p> <p>The FSO module and, as a result, all its I/O channels are passivated.</p> <p>Possible reasons for module passivation are:</p> <ol style="list-style-type: none"> 1. PROFIsafe communication failure (CRC error) 2. PROFIsafe watchdog timeout exceeded. <p>The drive is stopped using the configured method. In the end, the drive STO is activated. The fail-safe value "0" is set to all I/O channels.</p> <p>If the connection to the PROFIsafe F-Host is possible, the fail-safe value "0" is transferred to the safety PLC for all I/O channels.</p> <p>If the PROFIsafe communication is broken, the safety application continuously attempts to establish a communication to the safety PLC.</p> <p>A state transition to another RUN state is possible only if the detected error has been solved.</p> <p>PROFIsafe Status Byte bits in the F-Host for the FSO module (if communication is possible):</p> <ul style="list-style-type: none"> • OA_Req_S = 0 • FV_activated_S = 1 • Device_Fault = 0 • CE_CRC = 1, in case of a communication error, CE_CRC = 0, otherwise • WD_timeout = 1, in case of a watchdog timeout, WD_timeout = 0, otherwise <p>ABB_PS1 or ABB_PS2 profile bits in the F-Host for the FSO module:</p> <ul style="list-style-type: none"> • FSO_mode.1 = 0 • FSO_mode.0 = 1 • SF_end_ack_req_local = 0 • SF_end_ack_req = 0 • FSO_state = 1

State	Description
Safe (Module passivation with a command)	<p>PROFIsafe communication is up and running. The FSO application is running without any detected errors.</p> <p>The FSO module and all its I/O channels are passivated because the safety application on the safety PLC requested a module passivation (activate_FV_C = 1 was set).</p> <p>The drive is stopped using the configured method. In the end, the drive STO is activated and the FSO module is in the Safe state. The fail-safe value "0" is set to all I/O channels. The fail-safe value "0" is transferred to the safety PLC for all I/O channels.</p> <p>PROFIsafe Status Byte bits in the F-Host for the FSO module:</p> <ul style="list-style-type: none"> • OA_Req_S = 0 • FV_activated_S = 1 • Device_Fault = 0 <p>ABB_PS1 or ABB_PS2 profile bits in the F-Host for the FSO module:</p> <ul style="list-style-type: none"> • FSO_mode.1 = 0 • FSO_mode.0 = 1 • SF_end_ack_req_local = 0 • SF_end_ack_req = 0 • FSO_state = 1
Safe (User acknowledgement request)	<p>PROFIsafe communication is up and running. The FSO application is running without any errors but waits for the acknowledgment of a module reintegration (module error has been solved).</p> <p>The FSO module is in the Safe state. The fail-safe value "0" is still transferred to the safety PLC for all input channels. All output channels have a state of "0". The OA_Req_S bit is reported as "1".</p> <p>As soon as the safety application in the safety PLC sets OA_C (positive edge), the FSO module goes to the Operational state if no further errors are detected. The OA_C must be "1" until OA_Req_S starts to deliver "0".</p> <p>PROFIsafe Status Byte bits in the F-Host for the FSO module:</p> <ul style="list-style-type: none"> • OA_Req_S = 1 • FV_activated_S = 1 • Device_Fault = 0 <p>ABB_PS1 profile bits in the F-Host for the FSO module:</p> <ul style="list-style-type: none"> • FSO_mode.1 = 0 • FSO_mode.0 = 1 • SF_end_ack_req_local = 0 • SF_end_ack_req = 0 • FSO_state = 1

State	Description
Fail-safe	<p>The FSO application keeps the system in the Fail-safe mode. PROFIsafe communication is up and running.</p> <p>This state is reached if a fatal error (for example, CPU test, RAM test, I/O channel test etc. failed) takes place.</p> <p>The drive is stopped using the configured method. In the end, the drive STO is activated. The fail-safe value "0" is set to all I/O channels. The fail-safe value "0" is transferred to the safety PLC for all I/O channels.</p> <p>This state can be left only to the Start-up mode by cycling power of the FSO module or by giving the reset command via the drive (parameter <i>96.09 FSO reboot</i>, see the drive firmware manual).</p> <p>PROFIsafe Status Byte bits in the F-Host for the FSO module:</p> <ul style="list-style-type: none"> • OA_Req_S = 0 • FV_activated_S = 1 • Device_Fault = 1 <p>ABB_PS1 or ABB_PS2 profile bits in the F-Host for the FSO module:</p> <ul style="list-style-type: none"> • FSO_mode.1 = 1 • FSO_mode.0 = 0 • SF_end_ack_req_local = 0 • SF_end_ack_req = 0 • FSO_state = 1 <p>See also the Note on page 206.</p>
Configuration	<p>The FSO module is in the Safe state. Upon transferring to the Configuration mode, the FSO answers to one PROFIsafe frame. The fail-safe value "0" is transferred to the safety PLC for all I/O channels. After that PROFIsafe communication is not possible. The fail-safe value "0" is set to all I/O channels.</p> <p>This state can only be entered from the Fail-safe mode or from any other state when the drive is not modulating.</p> <p>This state can be left only to the Start-up mode by cycling power of the FSO module or by giving the reset command via the drive (parameter <i>96.09 FSO reboot</i>, see the drive firmware manual).</p> <p>PROFIsafe Status Byte bits in the F-Host for the FSO module:</p> <ul style="list-style-type: none"> • OA_Req_S = 0 • FV_activated_S = 1 • Device_Fault = 0 <p>ABB_PS1 profile bits in the F-Host for the FSO module:</p> <ul style="list-style-type: none"> • FSO_mode.1 = 1 • FSO_mode.0 = 1 • SF_end_ack_req_local = 0 • SF_end_ack_req = 0 • FSO_state = 1 <p>See also the Note on page 206.</p>

Transitions between states

This table describes the transitions between the FSO module states. The numbering of the transitions refer to the transitions shown in the state diagrams on page 215.

ID	From	To	Description
1	Start-up	Safe (Module passivation with a command)	The FSO module goes to this state directly after Start-up during a normal start-up.
2	Operational	Start-up	The FSO module goes to this state by cycling power of the FSO module or by giving the reset command via the drive (parameter 96.09 FSO <i>reboot</i> , see the drive firmware manual).
3	Start-up	Safe (Module passivation)	PROFIsafe watchdog time or PROFIsafe communication error was detected directly after Start-up.
4	Safe (Module passivation)	Start-up	The FSO module goes to this state by cycling power of the FSO module or by giving the reset command via the drive (parameter 96.09 FSO <i>reboot</i> , see the drive firmware manual).
5	Start-up	Fail-safe	Fatal error(s) (CPU test, RAM test, etc. failed) detected.
6	Fail-safe	Start-up	The FSO module goes to the Start-up mode by cycling power of the FSO module or by giving the reset command via the drive (parameter 96.09 FSO <i>reboot</i> , see the drive firmware manual).
7	Operational	Safe (Module passivation & reintegration)	Execution of at least one safety function encountered a problem. The system reaches the Safe state. As soon as at least one of the errors can be acknowledged, it can be done locally, via PROFIsafe, or automatically depending on the FSO configuration.
8	Safe (Module passivation & reintegration)	Operational	All the related errors have been solved and acknowledged.
9	Operational	Fail-safe	Fatal error(s) (CPU test, RAM test, etc. failed) detected.
10	Operational	Safe (Module passivation)	PROFIsafe watchdog time or PROFIsafe communication error was detected.
11	Operational	Safe (Module passivation with a command)	Command "activate_FV_C = 1" was sent from the safety PLC.

ID	From	To	Description
12	Safe (Module passivation & reintegration)	Fail-safe	Fatal error(s) (CPU test, RAM test, etc. failed) detected.
13	Safe (Module passivation)	Fail-safe	Fatal error(s) (CPU test, RAM test, etc. failed) detected.
14	Safe (Module passivation & reintegration)	Start-up	The FSO module goes to this state by cycling power of the FSO module or by giving the reset command via the drive (parameter <i>96.09 FSO reboot</i> , see the drive firmware manual).
15	Start-up	Start-up	The FSO module goes to this state by cycling power of the FSO module or by giving the reset command via the drive (parameter <i>96.09 FSO reboot</i> , see the drive firmware manual).
16	Safe (User acknowledgement request)	Fail-safe	Fatal error(s) (CPU test, RAM test, etc. failed) detected.
17	Safe (User acknowledgement request)	Start-up	The FSO module goes to this state by cycling power of the FSO module or by giving the reset command via the drive (parameter <i>96.09 FSO reboot</i> , see the drive firmware manual).
18	Safe (Module passivation with a command)	Safe (Module passivation)	PROFIsafe watchdog time or PROFIsafe communication error was detected.
19	Safe (Module passivation)	Safe (Module passivation with a command)	Module error (watchdog time or communication error (CRC)) has been solved and command "activate_FV_C = 1" is received.
20	Safe (User acknowledgement request)	Safe (Module passivation)	PROFIsafe watchdog time or PROFIsafe communication error was detected.
21	Safe (Module passivation)	Safe (User acknowledgement request)	Module error (watchdog time or communication error (CRC)) has been solved and <ul style="list-style-type: none"> • command "activate_FV_C = 0" then • the FSO module sets OA_Req_S = 1.
22	Safe (User acknowledgement request)	Operational	OA_C (positive edge) was set by the PROFIsafe F-Host for the FSO module.
23	Safe (User acknowledgement request)	Safe (Module passivation with a command)	Command "activate_FV_C = 1" was sent from the PROFIsafe F-Host.

ID	From	To	Description
24	Safe (Module passivation with a command)	Safe (User acknowledgement request)	Command "activate_FV_C = 0" has been received and "OA_Req_S = 1".
25	Safe (Module passivation with a command)	Fail-safe	Fatal error(s) (CPU test, RAM test, etc. failed) detected.
26	Safe (Module passivation with a command)	Start-up	The FSO module goes to this state by cycling power of the FSO module or by giving the reset command via the drive (parameter <i>96.09 FSO reboot</i> , see the drive firmware manual).
27	Safe (Module passivation with a command)	Operational	No module error and "activate_FV_C = 0".
28	Safe (Module passivation & reintegration)	Safe (Module passivation)	PROFIsafe watchdog or PROFIsafe communication error was detected.
29	Safe (Module passivation & reintegration)	Safe (Module passivation with a command)	Command "activate_FV_C = 1" was sent from the safety PLC.
30	Safe (User acknowledgement request)	Safe (Module passivation & reintegration)	OA_C (positive edge) was set by the PROFIsafe F-Host, but there are existing errors in the active safety functions or there are errors that need to be acknowledged.
31	Safe (Module passivation with a command)	Safe (Module passivation & reintegration)	Command "activate_FV_C = 0" was set by the PROFIsafe F-Host but there are existing errors in the active safety functions or there are errors that need to be acknowledged.
32	Any state when the motor is not running	Configuration	Drive Composer pro connects to the FSO module and as a result the FSO goes to the Configuration state.
33	Configuration	Start-up	From the Configuration mode, it is possible to go only to the Start-up mode by cycling power of the FSO module or by giving the reset command via the drive (parameter <i>96.09 FSO reboot</i> , see the drive firmware manual).

■ PROFIsafe response time

The safety function response time (SFRT) is the time within which the safety system must react after an error has occurred in the system.

SFRT is also the maximum time within which the safety system must respond to a change in the input signals.

According to *PROFIsafe System Description, Version November 2010*, SFRT for PROFIsafe devices can be defined as:

$$\text{SFRT} = \text{TWCDT} + \text{Longest } \Delta T_{\text{WD}}$$

where

- TWCDT (total worst-case delay time) is the maximum time for input signal transfer in the safety system until the output reaction under worst-case conditions (all components require the maximum time)
- Longest ΔT_{WD} is the longest time difference between the watchdog time for a given entity and the worst-case delay time.

In safety systems, to define SFRT you must take into account a potential single fault in one of the components during the signal transfer. It is enough to consider a single fault only (see *PROFIsafe System Description, Version November 2010*).

The worst-case delay time (WCDT) and watchdog (WD) values for the FSO and FENA modules are listed in the table below.

Device	WCDT	Device WD
FSO	50 ms	50 ms
FPNO-21	3 ms	-
FENA-21	3 ms	-

The documentation of the safety PLC defines how you can calculate the processing time and transmission time of the PROFIsafe connection.

For example, *AC500-S Safety User Manual (3ADR025091M0207 [English])* proposes that SFRT is calculated using the following formula:

$$\text{SFRT} = \text{Device_WD1} + 0.5 \times \text{F_WD_Time1} + \text{F_Host_WD} + 0.5 \times \text{F_WD_Time2} \\ + \text{Device_WD2} + \text{Longest } \Delta T_{\text{WD}}$$

where

- Device_WD1 is an internal input device watchdog time
- F_WD_Time1 is the watchdog time for receipt of the new valid telegram (from the input device to the safety PLC)
- F_Host_WD is the watchdog time of the safety PLC
- F_WD_Time2 is the watchdog time for receipt of the new valid telegram (from the safety PLC to the output)
- Device_WD2 is an internal output device watchdog time.

Instead of WCDDT values, the calculation uses watchdog times. See *AC500-S Safety User Manual* (3ADR025091M0207 [English]) for details.

For example, when using the ABB AI581-S as the input device, the SM560-S safety PLC and the FSO module as the output device, SFRT can be calculated as follows:

$$\begin{aligned} \text{SFRT} &= \text{Device_WD1} + 0.5 \times \text{F_WD_Time1} + \text{F_Host_WD} + 0.5 \times \text{F_WD_Time2} \\ &\quad + \text{Device_WD2} + \text{Longest } \Delta\text{T_WD} \\ &= 76.5 + 15 + 6 + 45.5 + 50 + 45.5 = 238.5 \text{ ms} \end{aligned}$$

where

- Device_WD1 = 76.5 ms
 - F_WD_Time1 = 30 ms
 - F_Host_WD = 6 ms
 - F_WD_Time2 = 91 ms
 - Device_WD2 = 50 ms
 - Longest $\Delta\text{T_WD}$ = Max (0.5 x F_WD_Time1; 0.5 x F_WD_Time2) = 45.5 ms (all other used WCDDT values are equal to their corresponding watchdog times).
-

■ PROFIsafe watchdog time

F-Parameter `F_WD_Time` determines the watchdog time for the PROFIsafe connection. The minimum watchdog time is composed of four timing sections as shown in this figure.

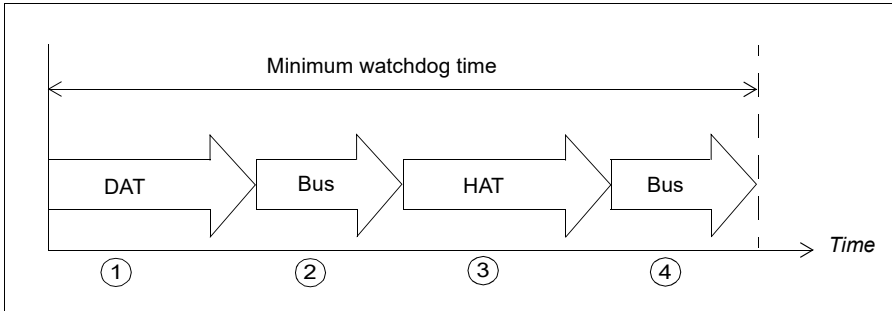

1. Device acknowledgement time (DAT) is the time it takes for the F-Device (such as the FSO module) to process an incoming PROFIsafe frame. DAT starts when the F-Device receives the PROFIsafe frame and ends when the F-Device has prepared a new PROFIsafe frame using the currently available process values.
2. Bus time is the time it takes when the PROFIsafe frame is transmitted from the F-Device (FSO module) to the F-Host (such as the ABB SM560-S safety controller station) through the "black channel".
3. Host acknowledgement time (HAT) is the time it takes for the F-Host to process an incoming PROFIsafe frame.
4. Another Bus time elapses when the new PROFIsafe frame is transmitted from the F-Host back to the F-Device.

`F_WD_Time` assigned to the FSO module must be higher than the minimum watchdog time. The worst-case delay time of the FSO module also depends on the safety functions that are used simultaneously and on the PROFIsafe cycle time. The longest worst-case delay time of the FSO module is 50 ms which is based on its internal watchdog.

Calculating the watchdog time

It is not always easy to calculate the worst-case delay time of “black channel” components. See *AC500-S Safety User Manual* (3ADR025091M0207 [English]) for a proposed method of tracing the actual PROFIsafe cycle times in a real system.

You must then set F_WD_Time about 30% higher than the worst-case value in variable tResponseTimeMS (in the AC500-S safety program) for the given safety device.

If you use this approach for the FSO module, you can set the PROFIsafe cycle time and the corresponding watchdog time F_WD_Time as short as possible for the given system.

If the longest recorded PROFIsafe cycle time (minimum F_WD_Time) is, for example, 40 ms, a suitable value for F_WD_Time is:

$$F_WD_Time = 40 \text{ ms} \times 1.3 = 52 \text{ ms}.$$

If you can calculate F_WD_Time instead, use the values given in the table on page [226](#). DAT time for the FSO module is 50 ms and the FENA-21 module adds 3 ms to both Bus times.

For example, if HAT is 6 ms and Bus times are 4 ms until FENA, F_WD_Time is:

$$F_WD_Time = (50 \text{ ms} + (3 \text{ ms} + 4 \text{ ms}) + 6 \text{ ms} + (4 \text{ ms} + 3 \text{ ms})) \times 1.3 = 91 \text{ ms}.$$

Installation

Installation procedure:

1. Install the FSO safety functions module to the drive, see chapters [Planning for installation](#) and [Installation](#) and the drive hardware manual.
 2. Install the FB module to the drive. See the appropriate manual:
 - *FENA-01/-11/-21 Ethernet adapter module user's manual* (3AUA0000093568 [English]), or
 - *FPNO-21 PROFINET adapter module user's manual* (3AXD50000158614 [English]).
 3. Connect the FB module to the safety PLC through a PROFINET network. See the manual of the module, and the manual of the safety PLC.
-

Configuration

■ Configuring the FB module

You can use either the drive control panel or the Drive Composer pro PC tool to modify the settings of the FB module.

Note: This section describes only the most important configuration steps. For more detailed information, see FPNO-21 PROFINET fieldbus adapter module user's manual (3AXD50000158614 [English]), *FENA-01/-11/-21 Ethernet adapter module user's manual* (3AUA0000093568 [English]) and the drive firmware manual.

Note: Example values in the table below are chosen based on the upcoming example project.

Parameters for the PROFINET communication

1. Depending on the drive, you can configure the FB module as fieldbus channel A or B. Enable the communication between the drive and the FB module for the option slot where the FB module is installed in (parameter *50.01 FBA A enable* or *50.31 FBA B enable*).
2. Set the FB module parameters that correspond to the selected fieldbus channel. Parameter groups 51, 52 and 53 include the settings for FBA A and groups 54, 55 and 56 for FBA B.

Groups 52, 53, 55 and 56 configure the contents of the normal PROFINET cyclic communication by mapping the words in the PROFINET frame to the desired drive parameters.

Groups 51 and 54 configure the PROFINET connection.

Index	Name/Value	Description	Example value
50.01	FBA A enable	Enables/disables communication between the drive and fieldbus adapter A and specifies the slot the adapter is installed into.	1
	Option slot 1	Communication between drive and fieldbus adapter A enabled. The adapter is in slot 1.	
50.31	FBA B enable	Enables/disables communication between the drive and fieldbus adapter B, and specifies the slot the adapter is installed into.	0
	Disable	Communication between drive and fieldbus adapter B disabled.	
51/54.01	FBA A/B type	Shows the type of the connected fieldbus adapter module A/B. This parameter is read-only.	Ethernet

Index	Name/Value	Description	Example value
51/54.02	FBA A/B PAR2 (PROTOCOL/PROFILE)	Selects one of the PNIO profiles.	11
	PNIO ABB Pro	Profile PNIO ABB Pro is selected	
51/54.03	FBA A/B PAR2 (COMMRATE)	Sets the Ethernet communication rate.	0
	Auto	Ethernet communication rate is negotiated automatically by the device.	
51/54.04...13	IP CONFIGURATION	The user can set the IP configuration for the network in these parameters or in the PLC project.	Static IP 0
51/54.20	Telegram type	Shows the telegram type for the selected I/O communication. This parameter is read-only.	4
	PPO4	PPO Type 4	
51/54.21	Alarm disable	Enables/disables the sending of diagnostic messages to the PROFINET network.	0
	Enabled	Diagnostic messages are sent.	
51/54.27	FBA A/B PAR REFRESH	Validates any changed FB module configuration settings and reboots the FB module taking all the changes to the drive parameters in use. After refreshing, the value reverts automatically to Done (0). Note: This parameter cannot be changed while the drive is running.	1
	REFRESH	Refreshing.	

Note: When the FB module is installed to the drive for the first time, you must set the value of parameter 51/54.02 to one of the PROFINET profiles (value 11 if a drop-down list is unavailable) and reboot the FB module with parameter 51/54.27. Only after this, the rest of the parameters in group 51/54 get the correct texts and options. If required, you must reconnect Drive Composer pro to the drive to get the parameters show up correctly (select **Refresh** from the **New** menu).

See the FB module user's manual and the drive firmware manual for all necessary parameter settings and detailed instructions on how to control the drive and motor using the normal PROFINET cyclic communication.

■ Configuring the FSO module

Set the FSO module parameters as described in section [Configuring the safety fieldbus communication](#) on page 320.

■ Configuring the safety PLC

After the drive has initialized the FB module, you must prepare the safety PLC for communication with the adapter module. Examples of ABB AC500-S Safety PLC and Siemens SIMATIC Fail-safe S7 PLC are given below. The examples include the minimum required steps for starting the PROFINET and PROFIsafe communication with the FB and FSO modules. For detailed information, see the documentation of your safety PLC.

The examples apply to all drive types that are compatible with the FB and FSO modules.

■ Downloading the GSD file

To configure the controller station, you need a type definition (GSD) file. In PROFINET IO, the GSD file is written in an XML-based language called GSDML.

Download the FB module GSD file from the ABB Document library (www.abb.com/drives/documents). The file name format is: **GSDML-Vx.x-ABB-FENA-yyyyymmdd.xml** or **GSDML-Vx.x-ABB-FPNO-yyyyymmdd.xml**.

- [FPNO GSDML file](#)
- [FENA GSDML file](#)

The GSD file describes the vendor-specific, PROFIdrive-specific and PROFIsafe-specific features of the adapter module. You can use the vendor-specific features, for example, in the ABB Drives communication profile. The PROFIdrive profile supports a set of services described in the PROFIdrive specification.

The actual PROFIsafe messages are processed in the FSO module. The GSD file and the instructions in this chapter refer to the FB module which is the device that is connected to PROFINET.

■ Configuring the ABB AC500-S Safety PLC

This example shows how to configure the communication between the ABB AC500-S Safety PLC and the FENA-21 adapter module using Automation Builder 2.0.

Before you use the safety configuration and programming tools in Automation Builder, you must study the AC500-S Safety PLC user manual (*AC500-S Safety User Manual* (3ADR025091M0207 [English])). Only qualified persons are allowed to work with the AC500-S Safety PLC.

You need a password to configure the safety parts of an Automation Builder project. In all new projects, there is a default user "Owner" with an empty password. This is a project administrator who can, for example, access the safety controller station. For detailed information on the passwords and access permissions in Automation Builder, see the AC500-S Safety PLC user manual.

You can find the complete documentation of ABB PLCs and Automation Builder 2.0 application in www.abb.com/PLC.

Before you start, make sure that you have downloaded the FENA GSD file from the ABB Document library. See section [Downloading the GSD file](#) on page 233.

1. Start the ABB Automation Builder application.
2. On the **Tools** menu, select **Device Repository**.
3. In the window that opens, click **Install...** and browse for the GSD file.

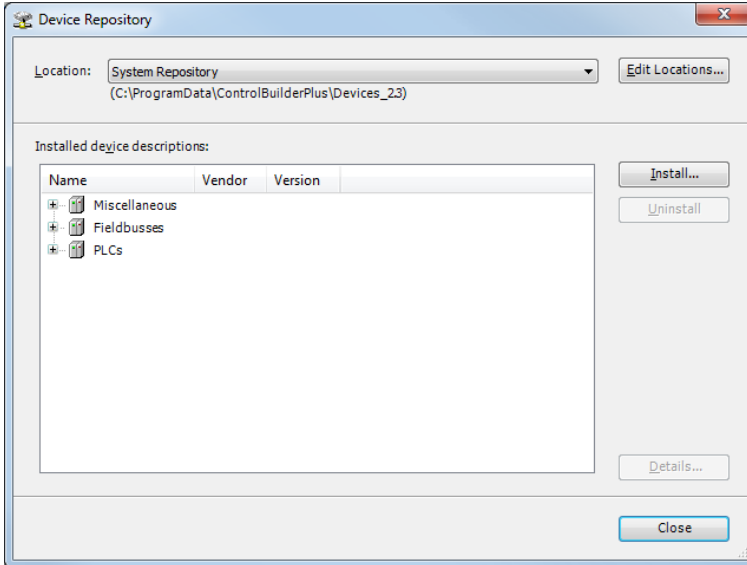

4. Open or create the PLC project that is used to control the drive.

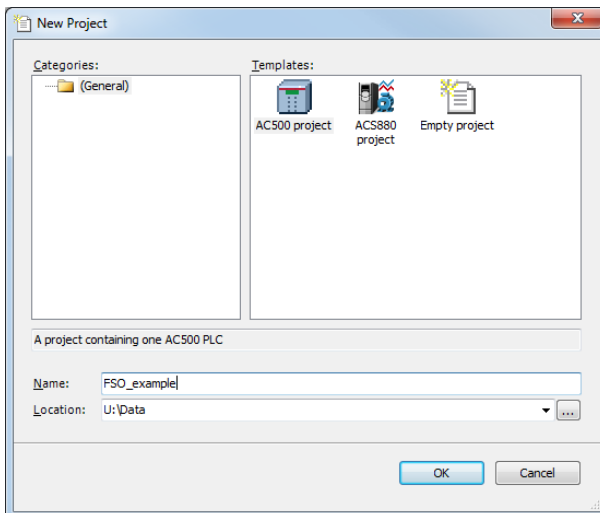

5. After creating the project, the following view is shown. Add the necessary controller devices to the PLC project.

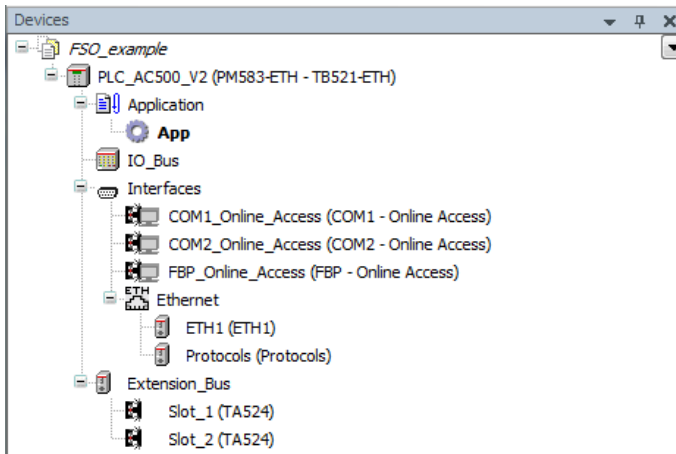

Next, add the necessary controller devices to the PLC project. First add the safety controller to slot 1 (make sure that the physical controller is in the same slot). Right-click on the slot, select Add object, and pick the SM560-S safety controller from the list.

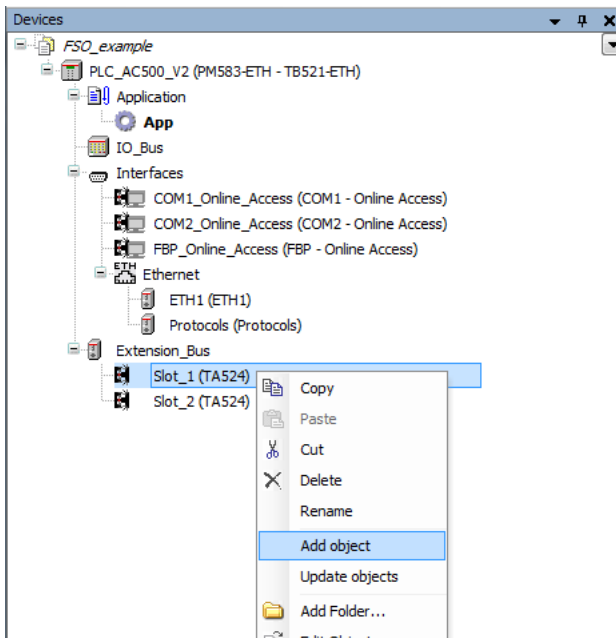

Note: When adding the safety controller, a login screen will appear. The default login information is:

User name: Owner

Password: (empty)

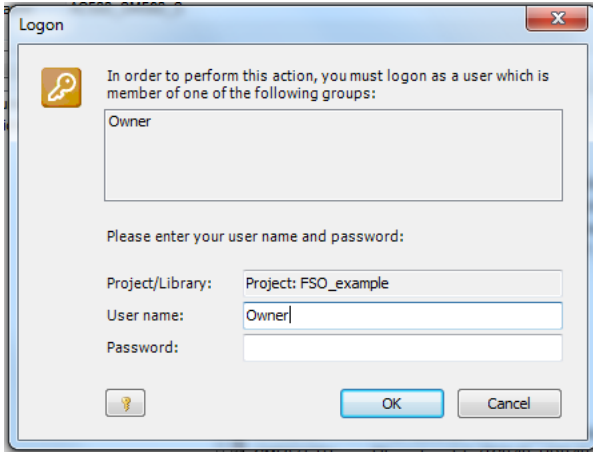

Next, in the same way, add the CM579-PNIO PROFINET master to slot 2.

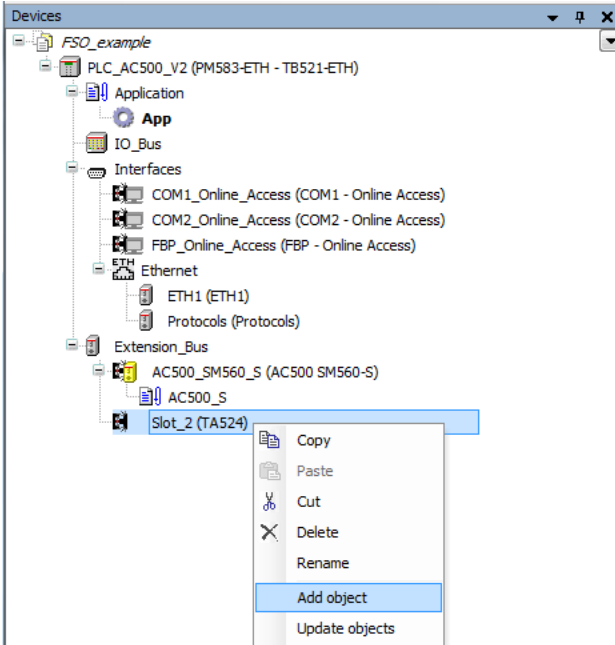

Note: Make sure that the “Enable debug” setting is On for the safety controller station, if you want to view or debug the PLC program after the download.

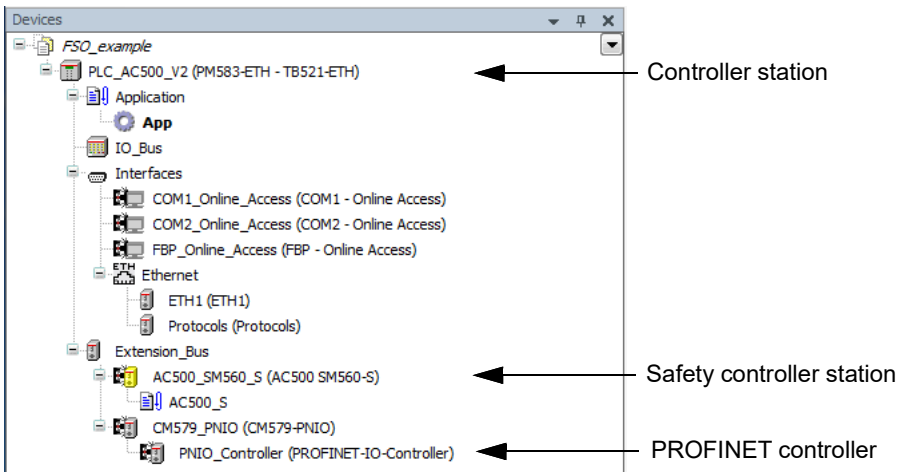

- Right-click on the PROFINET controller **CM579-PNIO-Master** and add the FENA module to the PROFINET IO network.

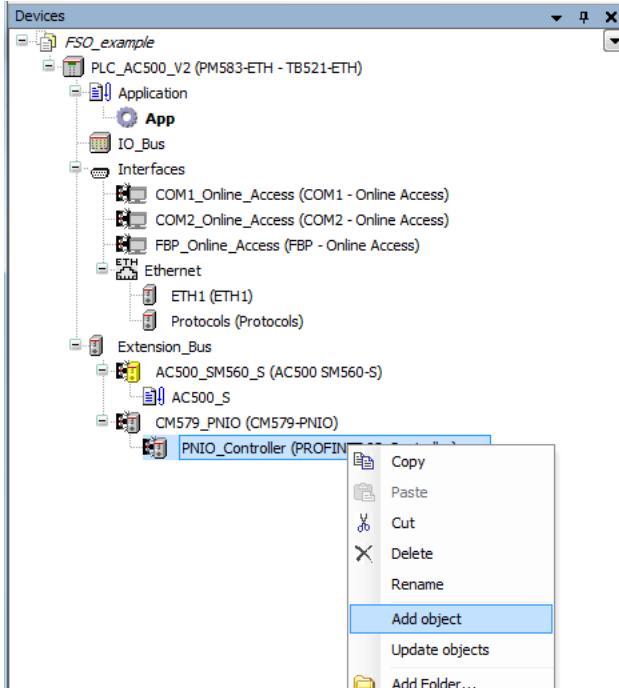

7. Add the desired I/O module, for example, “PPO Type 4” to the first slot of the FENA module to define cyclic communication between the module and the PLC.
8. Add the PROFIsafe module “PROFIsafe ABB_PS1” to the second slot of the FENA module to define cyclic communication between the module and the PLC.

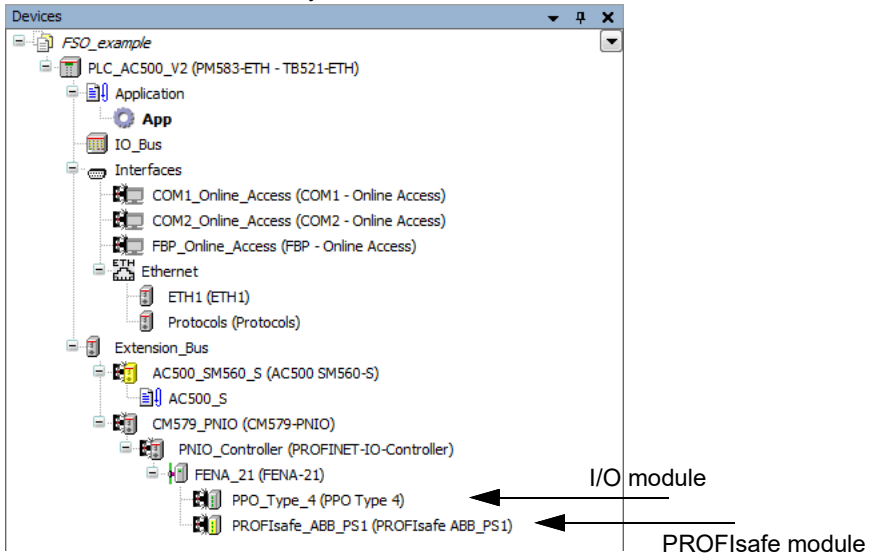

9. Define the PROFINET controller (CM579-PNIO) properties, such as the IP address and IP address settings for devices:

- Select **PNIO_Controller**.
- On the **PROFINET I/O Controller** tab, define the necessary IP addresses.

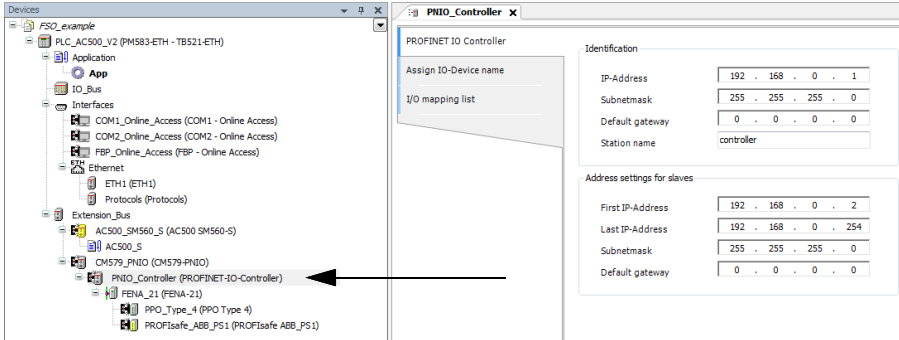

10. Define the FENA properties:

- Select **FENA_21**.
- On the **PNIO identification** tab, define the IP address and Subnet mask, and type the Station name (in this example, drive1).

Note: Use only lower case letters for the Station name.

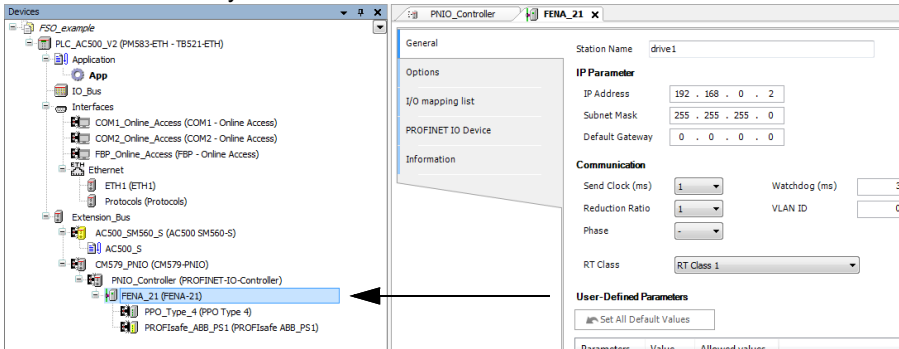

11. Set the communication parameters (if you have already done this, you can move on to the next step Create configuration data for safety and non-safety.).

- Right-click on the PLC_AC500_V2 controller and open the communication settings. Tick Use advanced settings and open the Advanced settings window.

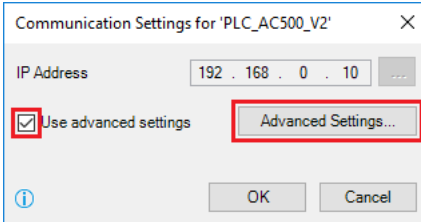

- In the advanced settings, create a new local profile with the following parameters:

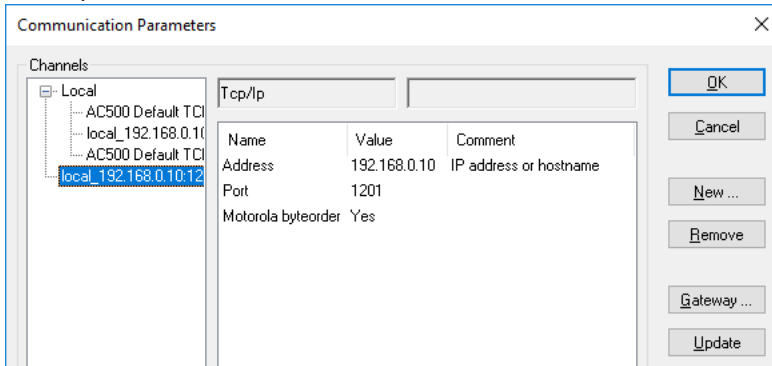

- Next open the CoDeSys safety program and choose Communication

parameters from the Online drop down menu.

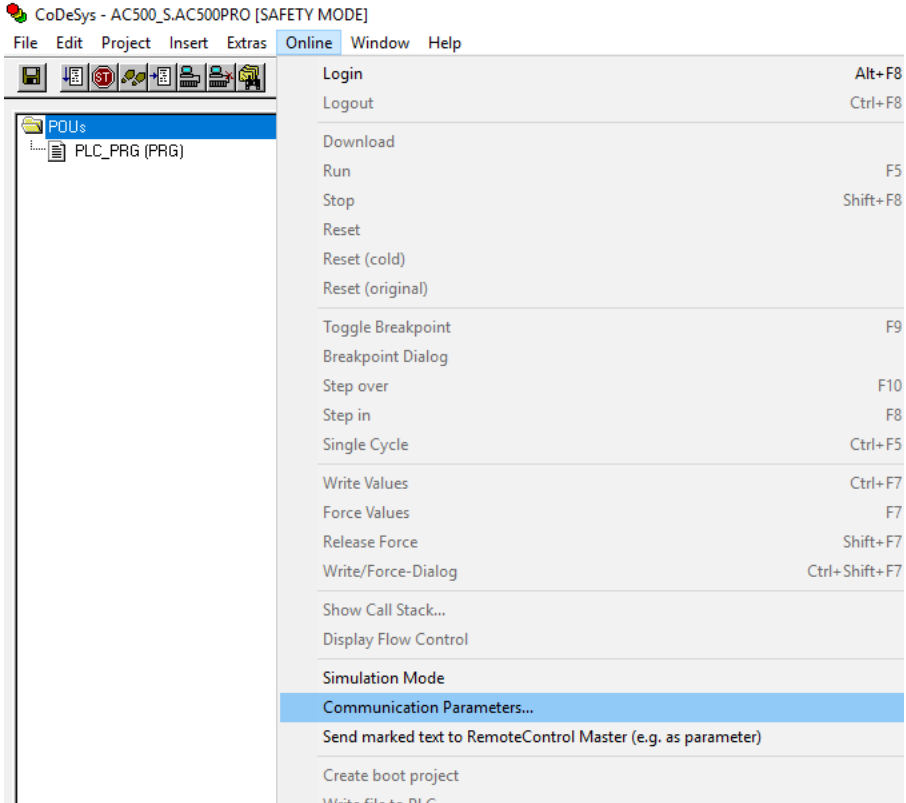

- Now create a new profile and fill in the following parameters:

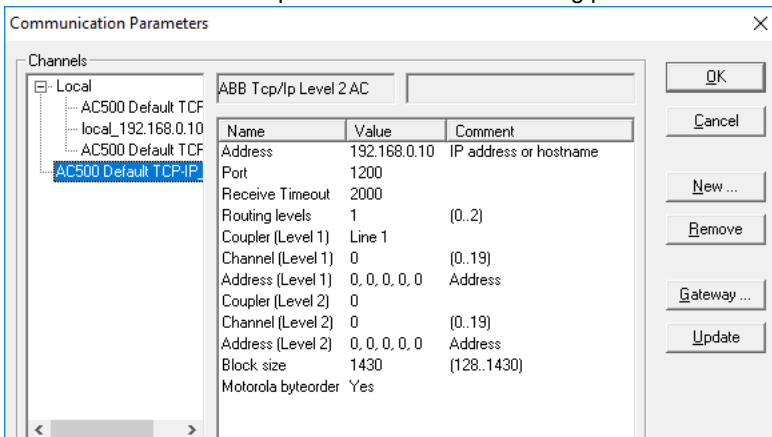

- Next check that your network adapter is in the same subnet. Open the

Windows network and sharing center and click on the network adapter.

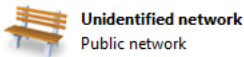

Access type: No network access
Connections: Local Area Connection 4

- Navigate to the IPv4 properties.

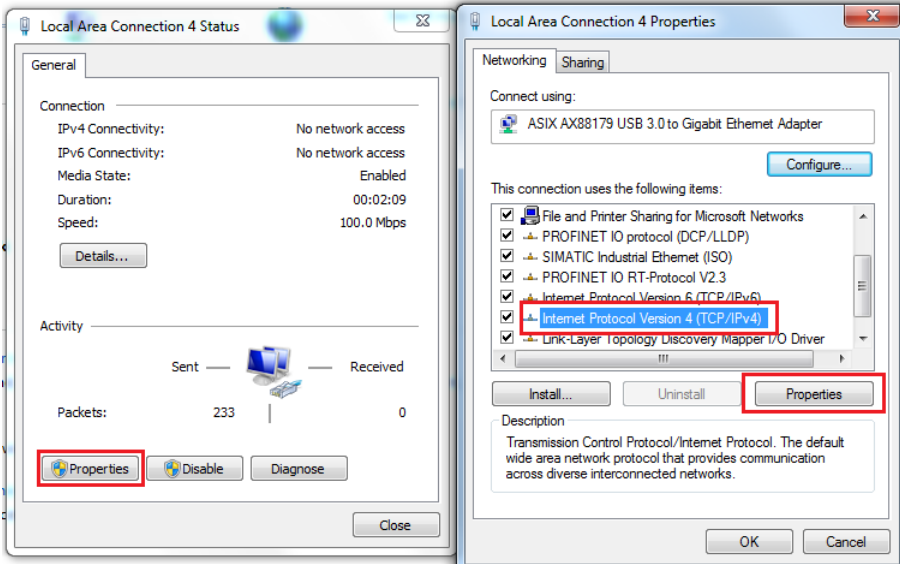

- Finally, set your subnet to the same range as the PLC. Check that the IP address is not in use on the network.

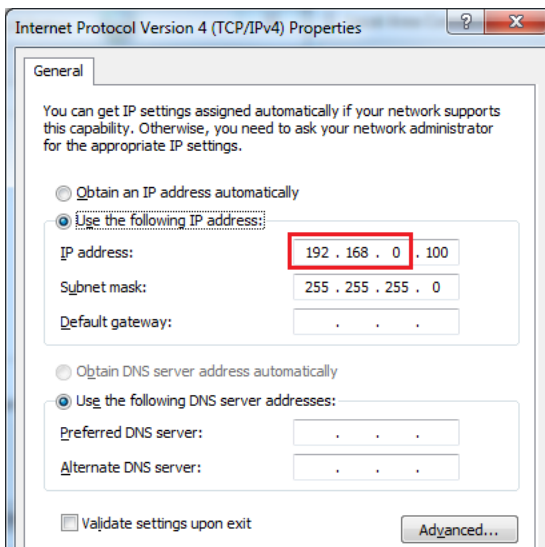

12. Create configuration data for safety and non-safety.

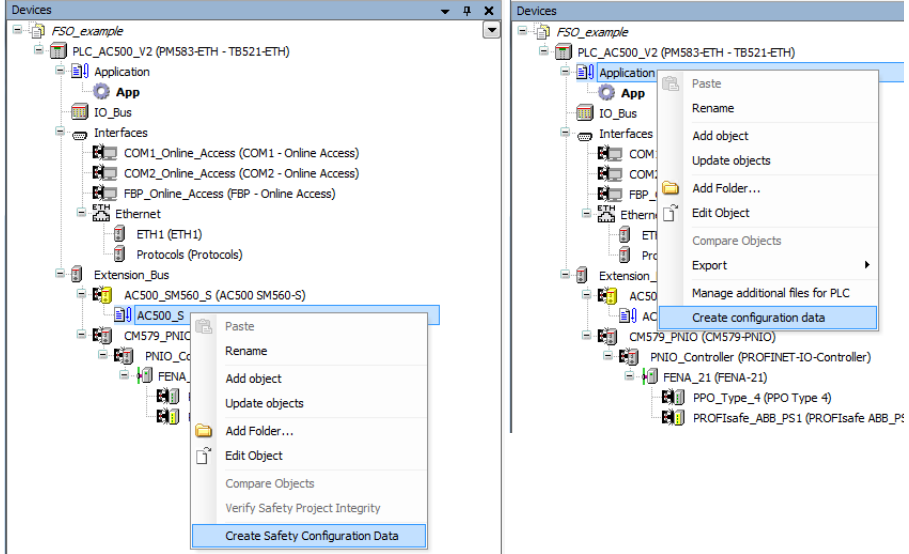

Note: The PROFIsafe source and destination addresses have to be different in order for the configuration process to work. Also, when creating safety data, some libraries will have to be created.

13. Return to the PROFINET controller (CM579-PNIO) properties. On the **Assign I/O Device Name** tab:

- Click **Connect to PLC (Login)** and select the communication link used between Automation Builder and the PLC.
- Click **Scan** to find all PROFINET devices connected to the network.
- In the **Configure station name** box, select the station name defined for the module in step 10 (in this example, drive1), and click **Assign I/O Device name**.
- In the **IP address** and **Network mask** boxes, type the IP address and subnet mask defined in step 11, and click **Assign IP configuration**.

14. Define the I/O module properties:

- Select the I/O module **PPO_Type_4**.
- On the **General** tab, configure the Stop Mode Action and Control-zero mode functions, and define Fail safe values for the PLC output process data (PZDs).

The screenshot shows the configuration window for the 'PPO_Type_4' module. The 'General' tab is selected, showing the following information:

Module Information:

- Ident Number: 16#00000104
- Slot Number: 1

User-Defined Parameters:

Set All Default Values

Parameters	Value	Allowed values
Stop Mode Action selection	Freeze data	0..2
Control-zero mode selection	Use data	0..1
Fail safe Control Word	0	0..65535
Fail safe Reference	0	0..65535
Fail safe value of RefPZD3	0	0..65535
Fail safe value of RefPZD4	0	0..65535
Fail safe value of RefPZD5	0	0..65535
Fail safe value of RefPZD6	0	0..65535

- Rename the I/O modules, for example, drive1_PPO4 and drive1_ABB_PS1.
- On the **PNIO Module I/O Mapping** tab, type names for the variables that refer to the drive's signals in the PLC program. (See section [ABB_PS1 profile F-Output user data](#) on page 204.)

The screenshot shows the configuration window for the 'drive1_PPO4' module. The 'PNIO Module I/O Mapping' tab is selected, displaying the following table:

Object Name	Variable	Channel
drive1_PPO4	drive1Status	Status
drive1_PPO4	drive1SpeedAct	Speed Actual
drive1_PPO4	drive1ActPZD3	Actual PZD3
drive1_PPO4	drive1ActPZD4	Actual PZD4
drive1_PPO4	drive1ActPZD5	Actual PZD5
drive1_PPO4	drive1ActPZD6	Actual PZD6
drive1_PPO4	drive1ActCommand	Command
drive1_PPO4	drive1SpeedRef	Speed Reference
drive1_PPO4	drive1RefPZD3	Reference PZD3
drive1_PPO4	drive1RefPZD4	Reference PZD4
drive1_PPO4	drive1RefPZD5	Reference PZD5
drive1_PPO4	drive1RefPZD6	Reference PZD6

15. Define the PROFIsafe module properties:

- Select the PROFIsafe module **PROFIsafe_ABB_PS1**.

On the **F-Parameter** tab, modify the PROFIsafe safety parameters.

Three of the listed parameters can be modified for FENA:

The screenshot shows the 'F-Parameters for safety device' configuration window for the 'PROFIsafe_ABB_PS1' module. The 'F-Parameter' tab is active, displaying a table of parameters. The 'F_Dest_Add' parameter is highlighted in blue, indicating it is selected for modification.

Name	Value	Symbolic-Value	Description
F_SIL	2	SIL3	SIL1 SIL2 SIL3
F_CRC_Length	0	3-Byte-CRC	3-Byte-CRC
F_Par_Version	1	1	1..1
F_Source_Add	1	1	1..65534
F_Dest_Add	100	100	1..65534
F_WD_Time	200	200	200..65535
F_Par_CRC	30784	30784	0..65535
Device Info	GSDML-V2.31-A...	GSDML-V2.31-A...	F-Parameters
Creator Info	SafetyGSDMLCo...	SafetyGSDMLCo...	

- F_Source_Add is the address of the safety controller station (in this example, AC500 SM560-S).
- F_Dest_Add is the address of the FENA module. This is defined by FSO parameter *PROFIsafe.11*, see section *Configuring the safety fieldbus communication* on page 320.

These two define the codename for the PROFIsafe relationship of this particular FENA module and the safety controller station.

- F_WD_Time is the PROFIsafe watchdog time. See section [Calculating the watchdog time](#) on page 229 for instructions on how to calculate the correct watchdog time.
- On the **PNIO Module Safety I/O Mapping** tab, type names for the variables that refer to the PROFIsafe message data in the safety PLC program. (See section [ABB_PS1 profile F-Output user data](#) on page 204.)

Variable	Mapping	Channel	Type	Unit	Descr
ABB_PS1_In0		ABB_PS1 In0	UINT		
ABB_PS1_In1		ABB_PS1 In1	UINT		
ABB_PS1_In2		ABB_PS1 In2	UINT		
drive1_VarSLS_act		Variable SLS state	BOOL		
drive1_POUS_act		POUS active	BOOL		
drive1_out_x114_9		Safe output x114 9	BOOL		
drive1_out_x114_8		Safe output x114 8	BOOL		
drive1_out_x114_7		Safe output x114 7	BOOL		
drive1_out_x113_9		Safe output x113 9	BOOL		
drive1_out_x113_8		Safe output x113 8	BOOL		
drive1_out_x113_7		Safe output x113 7	BOOL		
drive1_SF_EndAc...		SF end ack req	BOOL		
drive1_SF_EndAc...		SF end ack req local	BOOL		
drive1_STO_act		STO control active	BOOL		
drive1_SpeedValu...		Speed value valid	BOOL		
drive1_FSO_state		FSO state	BOOL		
drive1_FSO_mode0		FSO mode0	BOOL		
drive1_FSO_mode1		FSO mode1	BOOL		
drive1_Modulating		Modulating	BOOL		
drive1_PS_Safe_Speed		ABB_PS1 In Safe Speed	INT		
ABB_PS1_Out0		ABB_PS1 Out0	UINT		
ABB_PS1_Out1		ABB_PS1 Out1	UINT		
drive1_PS_VarSLSlim		ABB_PS1 Out VarSLSlim	INT		

16. Create the configuration data for the controller station:

- Right-click on the **Application** and select **Create Configuration Data**.

17. Create the safety configuration data for the controller station:

- Right-click on the **AC500_S** and select **Create Safety Configuration Data**.

18. Download the safety and “non-safety” PLC programs. This is done through Codesys, by double clicking on "Application". Then in Codesys, open Online drop down menu and choose Login. Same is done to the safety program by double clicking on "AC500_S".

Note: The non-safety program may be empty, but the safety program must contain a watchdog in order for PROFIsafe to run.

19. Create a program that controls the drive:

- Double-click the **Application**. This opens the PLC program in the CoDeSys programming tool.

20. Create a safety program that controls the FSO via PROFIsafe:

- Double-click the **AC500_S**. This opens the safety PLC program in the CoDeSys programming tool.

Note: If you do not have an existing safety program, you must at least implement watchdog toggling.

WARNING! Do not use this safety program in real safety applications. This safety program is shown only as an example and can only be used for trial purposes.

```

0002 VAR
0003   SF_WDOG: SF_WDOG_TIME_SET;
0004   END_VAR
0005
0006
0007
0008
0009
0010 (* Toggle Watchdog *)
0011 SF_WDOG(
0012   EN:=TRUE;
0013   WDOG:=5;
0014   RESET:=FALSE;
0015   DONE=>;
0016   ACT_TIME=>;
0017   MAX_TIME=>;
0018
0019
0020 (* Automatic operator acknowledge for PROFIsafe *)
0021 IF drive1_ABB_PS1_OA_Req_S = TRUE THEN
0022   drive1_ABB_PS1_OA_C := TRUE;
0023 ELSE
0024   drive1_ABB_PS1_OA_C := FALSE;
0025 END_IF
0026
0027 (* Automatic acknowledge for FSO *)
0028 IF drive1_SF_end_ack_req = TRUE THEN
0029   drive1_SF_end_ack := TRUE;
0030 ELSE
0031   drive1_SF_end_ack := FALSE;
0032 END_IF
0033
0034
0035 (* Keep SLS3 active all the time *)
0036 drive1_SLS3_request := TRUE;
0037
0038
0039
0040
0041
0042
0043
0044
0045
0046
0047
0048
0049
0050
0051
0052
0053
0054
0055
0056
0057
0058
0059
0060
0061
0062
0063
0064
0065
0066
0067
0068
0069
0070
0071
0072
0073
0074
0075
0076
0077
0078
0079
0080
0081
0082
0083
0084
0085
0086
0087
0088
0089
0090
0091
0092
0093
0094
0095
0096
0097
0098
0099
0100
0101
0102
0103
0104
0105
0106
0107
0108
0109
0110
0111
0112
0113
0114
0115
0116
0117
0118
0119
0120
0121
0122
0123
0124
0125
0126
0127
0128
0129
0130
0131
0132
0133
0134
0135
0136
0137
0138
0139
0140
0141
0142
0143
0144
0145
0146
0147
0148
0149
0150
0151
0152
0153
0154
0155
0156
0157
0158
0159
0160
0161
0162
0163
0164
0165
0166
0167
0168
0169
0170
0171
0172
0173
0174
0175
0176
0177
0178
0179
0180
0181
0182
0183
0184
0185
0186
0187
0188
0189
0190
0191
0192
0193
0194
0195
0196
0197
0198
0199
0200
0201
0202
0203
0204
0205
0206
0207
0208
0209
0210
0211
0212
0213
0214
0215
0216
0217
0218
0219
0220
0221
0222
0223
0224
0225
0226
0227
0228
0229
0230
0231
0232
0233
0234
0235
0236
0237
0238
0239
0240
0241
0242
0243
0244
0245
0246
0247
0248
0249
0250
0251
0252
0253
0254
0255
0256
0257
0258
0259
0260
0261
0262
0263
0264
0265
0266
0267
0268
0269
0270
0271
0272
0273
0274
0275
0276
0277
0278
0279
0280
0281
0282
0283
0284
0285
0286
0287
0288
0289
0290
0291
0292
0293
0294
0295
0296
0297
0298
0299
0300
0301
0302
0303
0304
0305
0306
0307
0308
0309
0310
0311
0312
0313
0314
0315
0316
0317
0318
0319
0320
0321
0322
0323
0324
0325
0326
0327
0328
0329
0330
0331
0332
0333
0334
0335
0336
0337
0338
0339
0340
0341
0342
0343
0344
0345
0346
0347
0348
0349
0350
0351
0352
0353
0354
0355
0356
0357
0358
0359
0360
0361
0362
0363
0364
0365
0366
0367
0368
0369
0370
0371
0372
0373
0374
0375
0376
0377
0378
0379
0380
0381
0382
0383
0384
0385
0386
0387
0388
0389
0390
0391
0392
0393
0394
0395
0396
0397
0398
0399
0400
0401
0402
0403
0404
0405
0406
0407
0408
0409
0410
0411
0412
0413
0414
0415
0416
0417
0418
0419
0420
0421
0422
0423
0424
0425
0426
0427
0428
0429
0430
0431
0432
0433
0434
0435
0436
0437
0438
0439
0440
0441
0442
0443
0444
0445
0446
0447
0448
0449
0450
0451
0452
0453
0454
0455
0456
0457
0458
0459
0460
0461
0462
0463
0464
0465
0466
0467
0468
0469
0470
0471
0472
0473
0474
0475
0476
0477
0478
0479
0480
0481
0482
0483
0484
0485
0486
0487
0488
0489
0490
0491
0492
0493
0494
0495
0496
0497
0498
0499
0500
0501
0502
0503
0504
0505
0506
0507
0508
0509
0510
0511
0512
0513
0514
0515
0516
0517
0518
0519
0520
0521
0522
0523
0524
0525
0526
0527
0528
0529
0530
0531
0532
0533
0534
0535
0536
0537
0538
0539
0540
0541
0542
0543
0544
0545
0546
0547
0548
0549
0550
0551
0552
0553
0554
0555
0556
0557
0558
0559
0560
0561
0562
0563
0564
0565
0566
0567
0568
0569
0570
0571
0572
0573
0574
0575
0576
0577
0578
0579
0580
0581
0582
0583
0584
0585
0586
0587
0588
0589
0590
0591
0592
0593
0594
0595
0596
0597
0598
0599
0600
0601
0602
0603
0604
0605
0606
0607
0608
0609
0610
0611
0612
0613
0614
0615
0616
0617
0618
0619
0620
0621
0622
0623
0624
0625
0626
0627
0628
0629
0630
0631
0632
0633
0634
0635
0636
0637
0638
0639
0640
0641
0642
0643
0644
0645
0646
0647
0648
0649
0650
0651
0652
0653
0654
0655
0656
0657
0658
0659
0660
0661
0662
0663
0664
0665
0666
0667
0668
0669
0670
0671
0672
0673
0674
0675
0676
0677
0678
0679
0680
0681
0682
0683
0684
0685
0686
0687
0688
0689
0690
0691
0692
0693
0694
0695
0696
0697
0698
0699
0700
0701
0702
0703
0704
0705
0706
0707
0708
0709
0710
0711
0712
0713
0714
0715
0716
0717
0718
0719
0720
0721
0722
0723
0724
0725
0726
0727
0728
0729
0730
0731
0732
0733
0734
0735
0736
0737
0738
0739
0740
0741
0742
0743
0744
0745
0746
0747
0748
0749
0750
0751
0752
0753
0754
0755
0756
0757
0758
0759
0760
0761
0762
0763
0764
0765
0766
0767
0768
0769
0770
0771
0772
0773
0774
0775
0776
0777
0778
0779
0780
0781
0782
0783
0784
0785
0786
0787
0788
0789
0790
0791
0792
0793
0794
0795
0796
0797
0798
0799
0800
0801
0802
0803
0804
0805
0806
0807
0808
0809
0810
0811
0812
0813
0814
0815
0816
0817
0818
0819
0820
0821
0822
0823
0824
0825
0826
0827
0828
0829
0830
0831
0832
0833
0834
0835
0836
0837
0838
0839
0840
0841
0842
0843
0844
0845
0846
0847
0848
0849
0850
0851
0852
0853
0854
0855
0856
0857
0858
0859
0860
0861
0862
0863
0864
0865
0866
0867
0868
0869
0870
0871
0872
0873
0874
0875
0876
0877
0878
0879
0880
0881
0882
0883
0884
0885
0886
0887
0888
0889
0890
0891
0892
0893
0894
0895
0896
0897
0898
0899
0900
0901
0902
0903
0904
0905
0906
0907
0908
0909
0910
0911
0912
0913
0914
0915
0916
0917
0918
0919
0920
0921
0922
0923
0924
0925
0926
0927
0928
0929
0930
0931
0932
0933
0934
0935
0936
0937
0938
0939
0940
0941
0942
0943
0944
0945
0946
0947
0948
0949
0950
0951
0952
0953
0954
0955
0956
0957
0958
0959
0960
0961
0962
0963
0964
0965
0966
0967
0968
0969
0970
0971
0972
0973
0974
0975
0976
0977
0978
0979
0980
0981
0982
0983
0984
0985
0986
0987
0988
0989
0990
0991
0992
0993
0994
0995
0996
0997
0998
0999
1000

```

Loading library 'C:\Program Files (x86)\Common Files\CAA-Targets\ABB_AC500\AC500_V12\Library\SafetyBase_PROFIsafe_...'
Loading library 'C:\Program Files (x86)\Common Files\CAA-Targets\ABB_AC500\AC500_V12\Library\SafetyBlocks_PL_Copen_...'
Loading library 'C:\Program Files (x86)\Common Files\CAA-Targets\ABB_AC500\AC500_V12\Library\SafetyExt_AC500_V22.lib'
Loading library 'C:\Program Files (x86)\Common Files\CAA-Targets\ABB_AC500\AC500_V12\Library\SafetyUtil_CoDeSys_AC5...'
Loading library 'C:\Program Files (x86)\Common Files\CAA-Targets\ABB_AC500\AC500_V12\Library\Target_AC500_V22.lib'
Loading library 'C:\Program Files (x86)\Common Files\CAA-Targets\ABB_AC500\AC500_V12\Library\SysLibs\SYSLIBCALLBAC_...'

Ln: 14, Col: 31 ONLINE OV READ

Note: This example program also keeps the SLS3 function active all the time.

21. For the “non-safety” program:

- In the **Project** menu, select **Build**.
- In the **Online** menu, select **Login**.

Note: If there are communication problems at this point, select **Communication parameters...** from the **Online** menu.

Note: To make sure that the program is downloaded to the PLC (even when no changes have been made), select **Clean all** from the **Project** menu.

- In the window that opens, click **Yes**. This downloads the program to the PLC.
- In the **Online** menu, select **Create boot project**. This saves the program permanently to the PLC.
- In the **Online** menu, select **Logout**.

22. Repeat step 21 for the safety program.

23. Switch the power of both PLCs off and on.

24. For the “non-safety” program:

- In the **Online** menu, select **Login**.

25. In the **Online** menu of the “non-safety program”, select **Run**. This starts both programs.

Online	Window	Help
Login		Alt+F8
Logout		Ctrl+F8
Download		
Run		F5
Stop		Shift+F8
Reset		
Reset (cold)		
Reset (original)		
Toggle Breakpoint		F9
Breakpoint Dialog		
Step over		F10
Step in		F8
Single Cycle		Ctrl+F5
Write Values		Ctrl+F7
Force Values		F7
Release Force		Shift+F7
Write/Force-Dialog		Ctrl+Shift+F7
Show Call Stack...		
Display Flow Control		
Simulation Mode		
Communication Parameters...		
Sourcecode download		
Send marked text to RemoteControl Master (e.g. as parameter)		
Create boot project		
Write file to PLC		
Read file from PLC		
Show file information		

Monitoring the PROFIsafe message

It is possible to monitor the contents of the PROFIsafe message. For example:

1. Check the variable values in the **Current Value** column on the **PNIO Module I/O Mapping** tab.

The screenshot shows the 'drive1_ABB_PS1' configuration in the 'PNIO Module I/O Mapping' tab. The table below represents the data shown in the software interface.

Variable	Mapping	Channel	Address	Type	Current Value
* drive1_PS1_In1		ABB_PS1 In0	%IW2.6	UINT	0
* drive1_PS1_In2		ABB_PS1 In1	%IW2.7	UINT	136
* drive1_PS1_In3		ABB_PS1 In2	%IW2.8	UINT	40
* drive1_VarSLS_act...		Variable SLS active	%DX16.0	BOOL	FALSE
* drive1_POUS_acti...		POUS active	%DX16.1	BOOL	FALSE
* drive1_Out_x114_9		Safe output x114.9	%DX16.2	BOOL	FALSE
* drive1_Out_x114_8		Safe output x114.8	%DX16.3	BOOL	FALSE
* drive1_Out_x114_7		Safe output x114.7	%DX16.4	BOOL	FALSE
* drive1_Out_x113_9		Safe output x113.9	%DX16.5	BOOL	FALSE
* drive1_Out_x113_8		Safe output x113.8	%DX16.6	BOOL	FALSE
* drive1_Out_x113_7		Safe output x113.7	%DX16.7	BOOL	FALSE
* drive1_SF_end_a...		SF end ack req	%DX17.0	BOOL	FALSE
* drive1_SF_end_a...		SF end ack req local	%DX17.1	BOOL	FALSE
* drive1_STO_contr...		STO control active	%DX17.2	BOOL	FALSE
* drive1_Speed_vali...		Speed value valid	%DX17.3	BOOL	TRUE
* drive1_FSO_state		FSO state	%DX17.4	BOOL	FALSE
* drive1_FSO_mode0		FSO mode0	%DX17.5	BOOL	TRUE
* drive1_FSO_mode1		FSO mode1	%DX17.6	BOOL	FALSE
* drive1_Modulating		Modulating	%DX17.7	BOOL	FALSE
* drive1_PS_Safe_Speed		ABB_PS1 In Safe Speed	%IW2.9	INT	0
* drive1_PS1_Out1		PROFIsafe F Message trailer	%IB2.20		
* drive1_PS1_Out2		ABB_PS1 Out0	%QW2.6	UINT	0
* drive1_PS1_Out2		ABB_PS1 Out1	%QW2.7	UINT	0
* drive1_PS_var_SLS...		ABB_PS1 Out VarSLSlimit	%QW2.8	INT	0
* drive1_PS_Safe_Speed		PROFIsafe F Message trailer	%QB2.18		

■ Configuring the Siemens SIMATIC Fail-safe S7 PLC

This example shows how to configure the communication between the Siemens SIMATIC Fail-safe S7 PLC and the FENA-21 adapter module using SIMATIC Manager Step 7 (version V5.5+SP2) and S7 Distributed Safety Programming (version V5.4+SP5).

For detailed configuration instructions, see the documentation of the safety PLC (*S7 Distributed Safety - configuring and programming, Programming and Operating Manual, 07/2013, A5E00109537-05*).

Before you start, make sure that you have downloaded the FENA GSD file from the ABB Document library. See section [Downloading the GSD file](#) on page 233.

1. Start SIMATIC Manager and open/create a SIMATIC project.
2. Add the necessary objects to the project.
In this example, a SIMATIC 300 Station and an Industrial Ethernet object have been added.

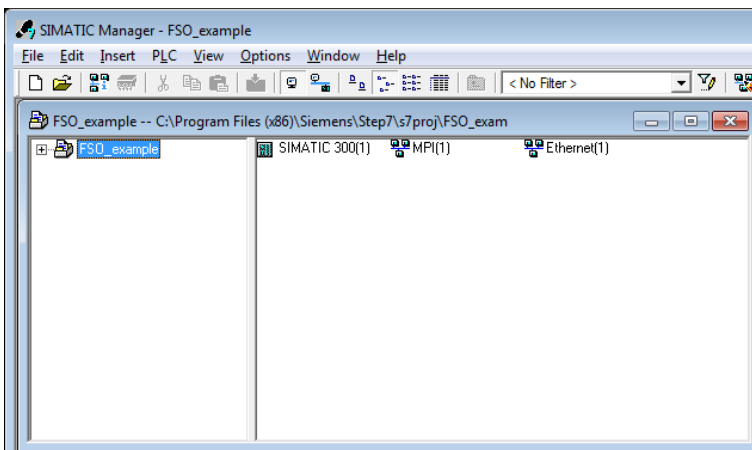

3. Open the hardware configuration of the project.
-

4. Select the controller station and rail from the catalog and drag them to the project. This example project uses a CPU 319F-3 controller station (V2.8) that is installed in a RACK-300 Rail.

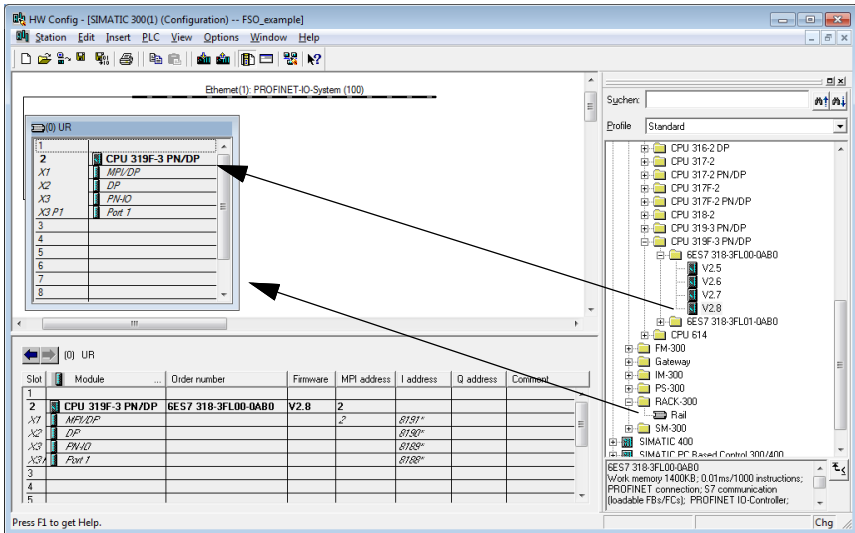

5. When you install the controller station to the rail, select Industrial Ethernet as the subnet for the controller station.

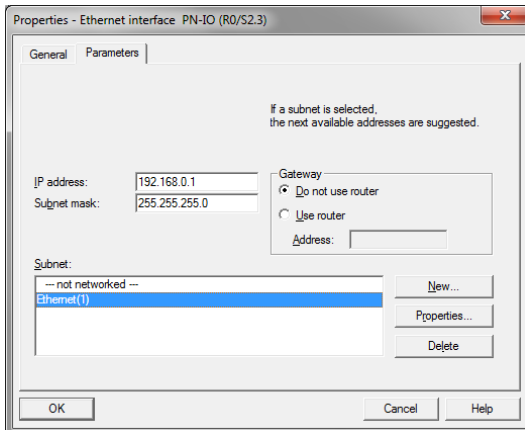

6. Install the FENA GSD file:
 - In the **Options** menu, select **Install GSD Files**.
 - Browse for the GSD file that you downloaded from the ABB Document library.
 - Click **Install**.

Note: In some versions of the SIMATIC environment, you have to close the whole SIMATIC program and open it again to make the new GSD file visible in the object catalogue.

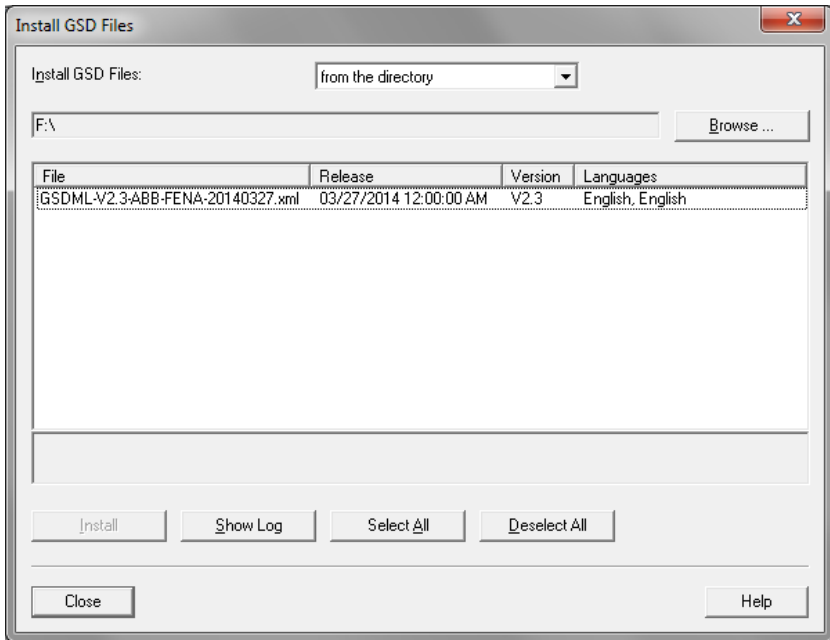

7. Click and drag the FENA object from the device catalog to the Ethernet (1): PROFINET-IO-System.

8. Click and drag the desired I/O object, for example PPO Type 4, to the first slot of the FENA module to define cyclic standard communication between the module and the PLC.
9. Click and drag the PROFIsafe object PROFIsafe ABB_PS1 to the second slot of the FENA module to define cyclic safety communication between the module and the PLC.

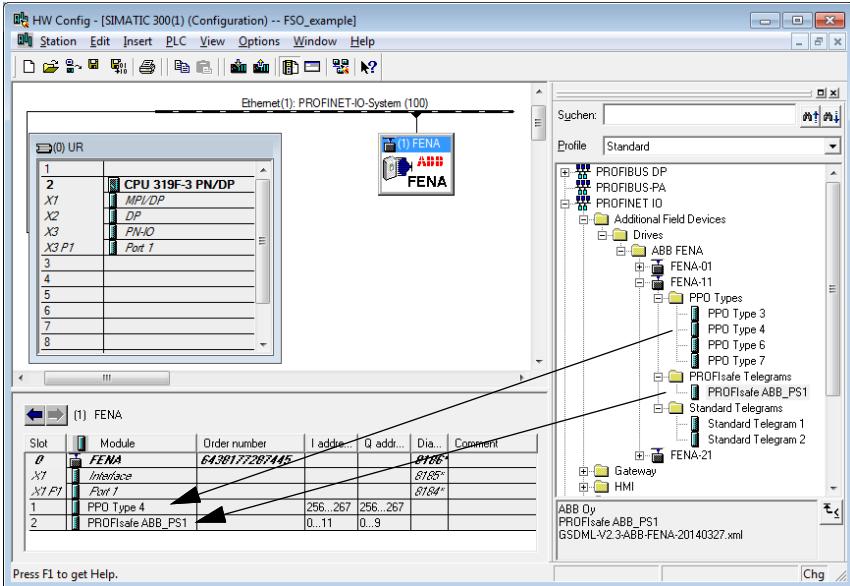

10. Double-click **FENA** to open the **Properties** window.

11. On the **General** tab, type the Device name for the adapter module (in this example, drive1).

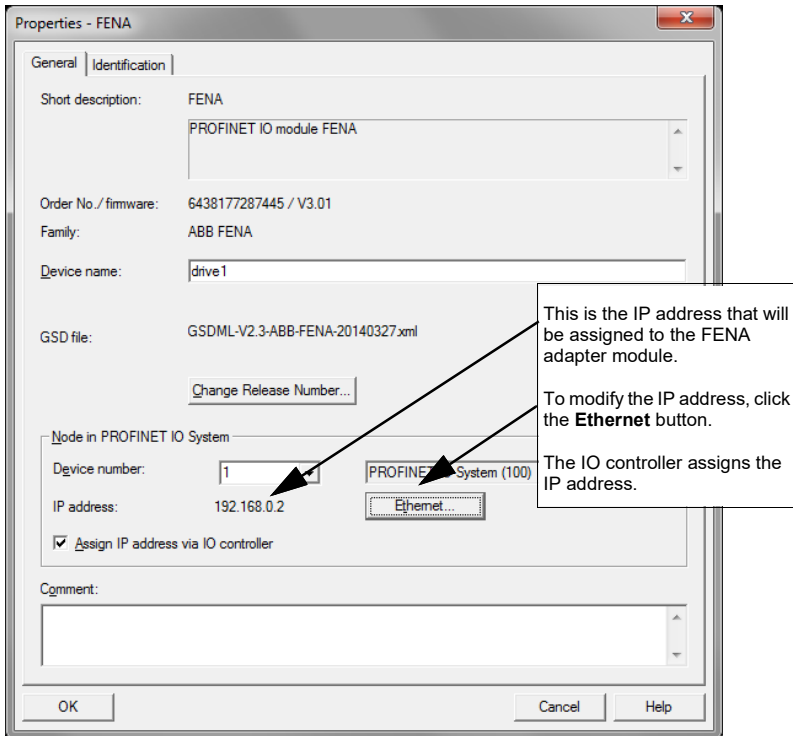

Note: Do not change the IP address assigned here. Use the same IP address for the FENA adapter module also in other tools (eg, the Drive Composer pro PC tool) which you use to connect to the drive.

12. Click **OK**.
13. In the hardware configuration, double-click the I/O object (PPO Type 4) in Slot 1 to open the **Properties** window.

14. Type a name for the I/O object (in this example, PROFIsafe ABB_PS1).

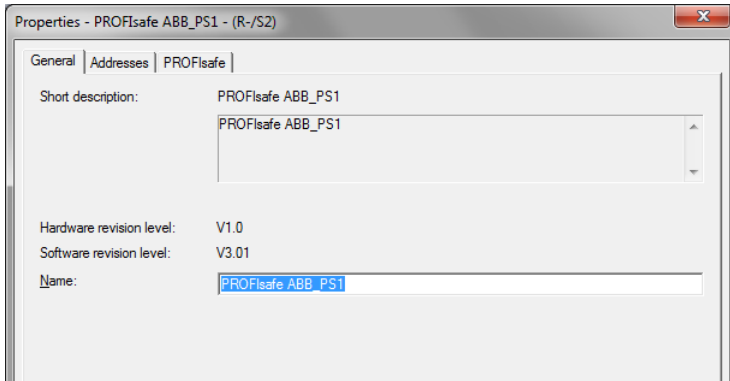

15. On the **Parameters** tab, configure the Stop mode and Control-zero mode functions, and define Fail safe values for the PLC output process data (PZDs).

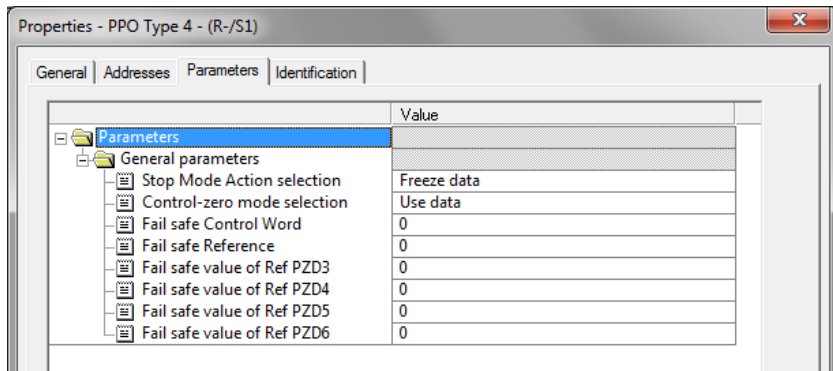

16. Assign the device name (defined in step 11) to the adapter module:

- In the hardware configuration, click **FENA**.
- In the **PLC** menu, select **Ethernet**, and select **Assign Device Name**.
- Click the **Update** button.
- Click the available device with the correct MAC address to which the device name will be assigned.
- Click **Assign name**. This assigns the name to the FENA module.
- Click **Close**.

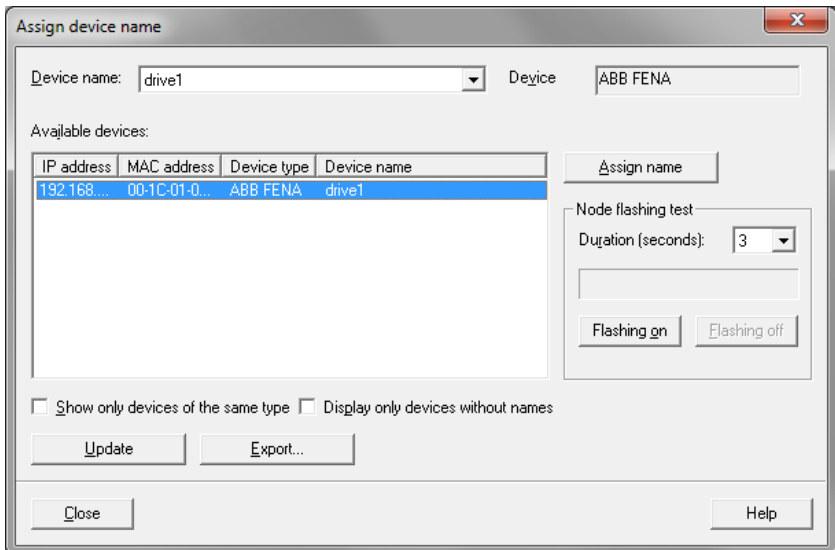

17. Check F-Parameters for the controller:

- In the hardware configuration, double-click the controller station (for example, CPU 319F-3).
- Select the **F Parameters** tab.
- When prompted, give the password for the Safety Program. See the documentation of the SIMATIC system for details.
- Make the necessary changes and click **OK**.

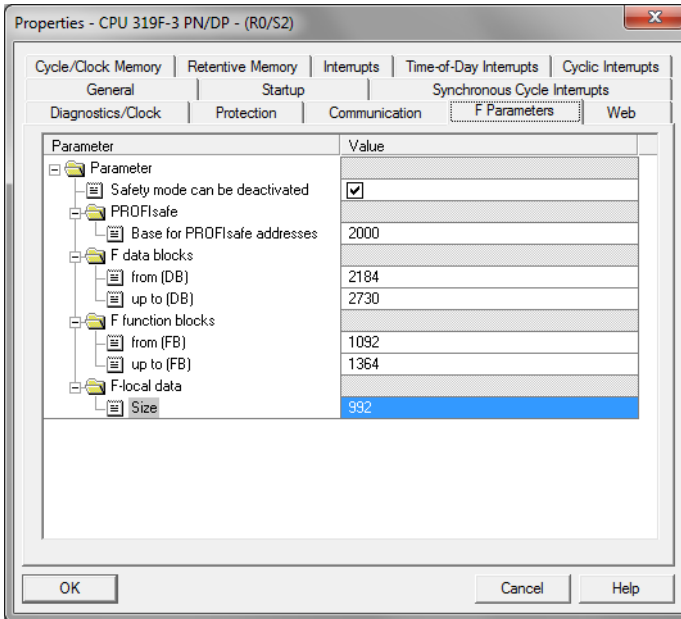

18. Set F-Parameters of the FENA module:

- In the hardware configuration, double-click **PROFIsafe ABB_PS1** to open the **Properties** window.
- On the **PROFIsafe** tab, modify the F_Dest_Add and F_WD_Time values as needed.
 - F_Source_Add is the address of the safety controller station. You can modify this in the **host** F Parameters tab.
 - F_Dest_Add is the address of the FENA module. This is defined by FSO parameter *PROFIsafe.11*, see section *Configuring the safety fieldbus communication* on page 320. These two define the codename for the PROFIsafe relationship of this particular FENA module and the safety controller station.
 - F_WD_Time is the PROFIsafe watchdog time. See section *Calculating the watchdog time* on page 229 for instructions on how to calculate the correct watchdog time.

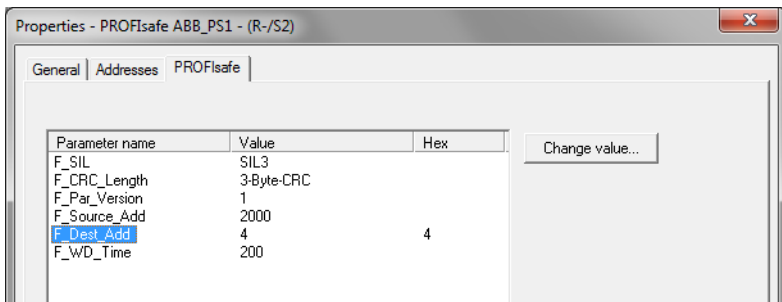

19. If necessary, you can give proper symbol names to the cyclic data:

- Right-click the I/O object (PPO Type 4) in Slot 1 and select **Edit Symbols...**
- Add names for the symbols.
- Repeat the same for the PROFIsafe object (PROFIsafe ABB_PS1) in Slot 2.

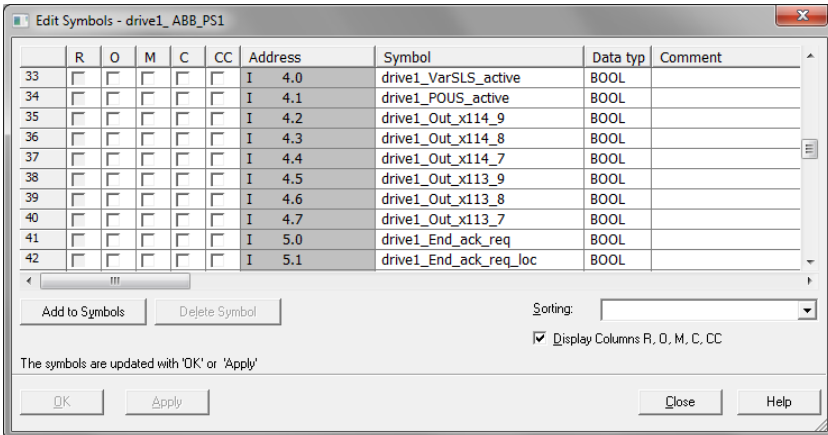

Note: In PROFINET communication, the bits of each octet are sent the most significant bit first. Therefore, the bits of every octet in the PROFINET message are in reversed order compared to the bits shown in the figure. For example, the first bit that is sent in the PROFINET message is the 7th bit of the first octet (I 0.7).

20. Check the protection of the controller station:

- In the hardware configuration, double-click the controller station (for example, CPU 319F-3).
- Select **Protection** tab.
- Select **1: Access protect. for F CPU**.
- Check **Can be bypassed with password**.
- Enter the password twice to the edit boxes.
- Check **CPU contains safety program**.

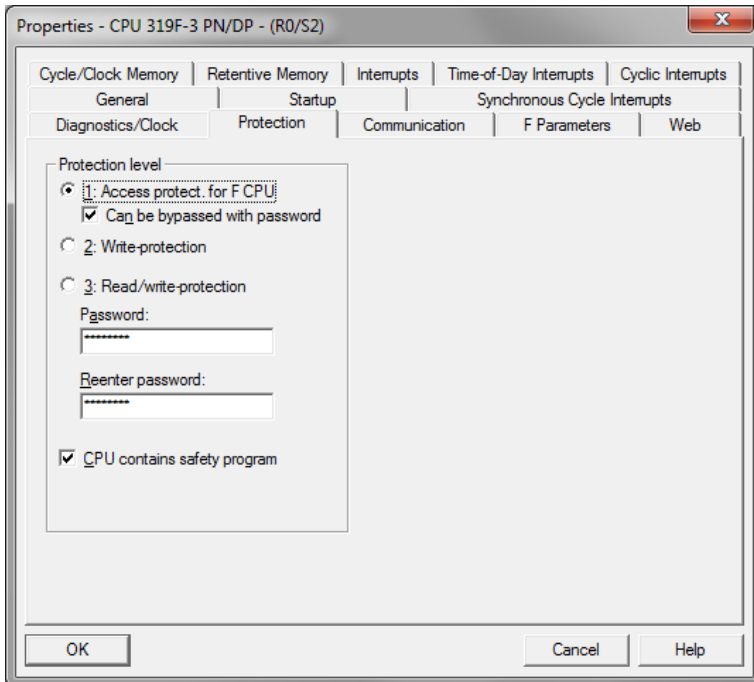

21. Save, compile and download the hardware configuration to the PLC.

The PLC is now ready for communication with the FENA adapter module.

Configuring the communication when there is no safety program

If there is no safety program in the project, these instructions can help you to get the communication working.



WARNING! Do not use this safety program in real safety applications. This safety program is only an example which you can use only for trial purposes to get the system up and running.

1. In SIMATIC Manager, right-click on the **Blocks** folder of the S7 Program of the project.
2. Select **Insert New Object**, and add the following blocks to the program:
 - Organization Block OB35 to call the safety program cyclically.
 - Function Block FB1 using F-FBD language.
 - Function FC1 using F-CALL language.

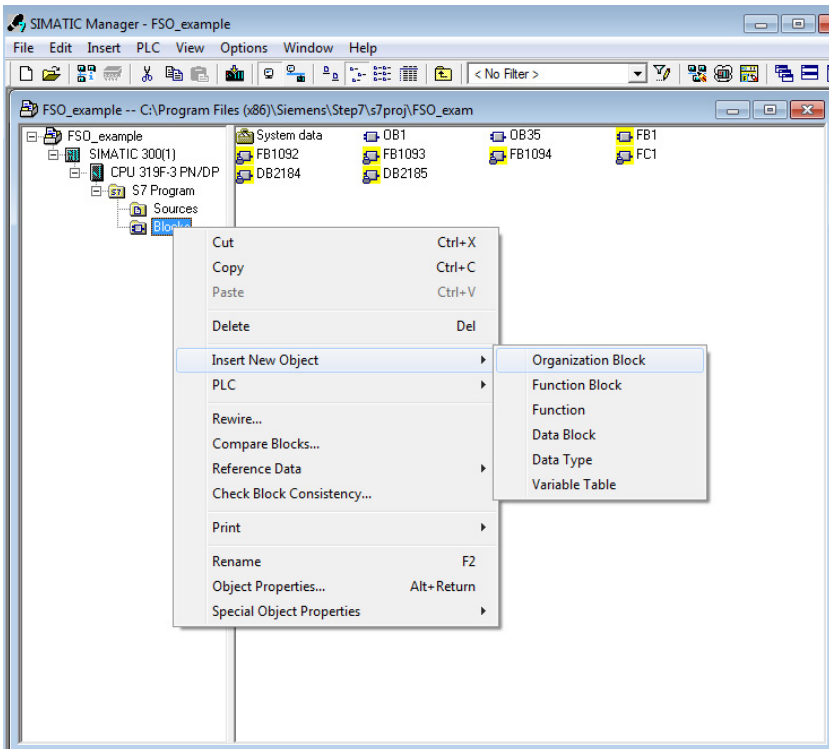

3. Double-click on the **FC1** block.

4. Set DB1 as the I-DB for the F-program block and FB1 as the F-program block.
5. Click **OK** and close the dialog windows.

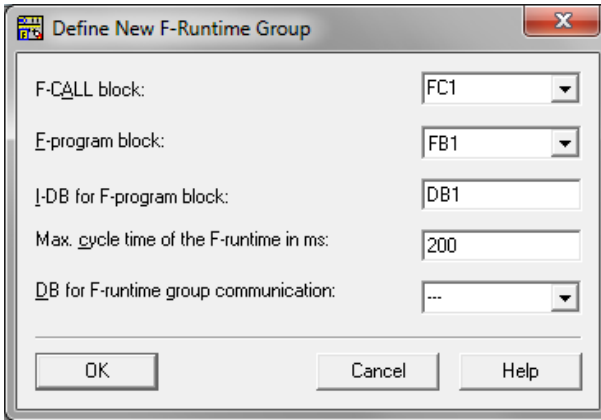

6. In SIMATIC manager, double-click on **OB35**.
7. Add call to FC1 by dragging the FC1 block from the FC blocks folder.
8. Save the block and close the editor.

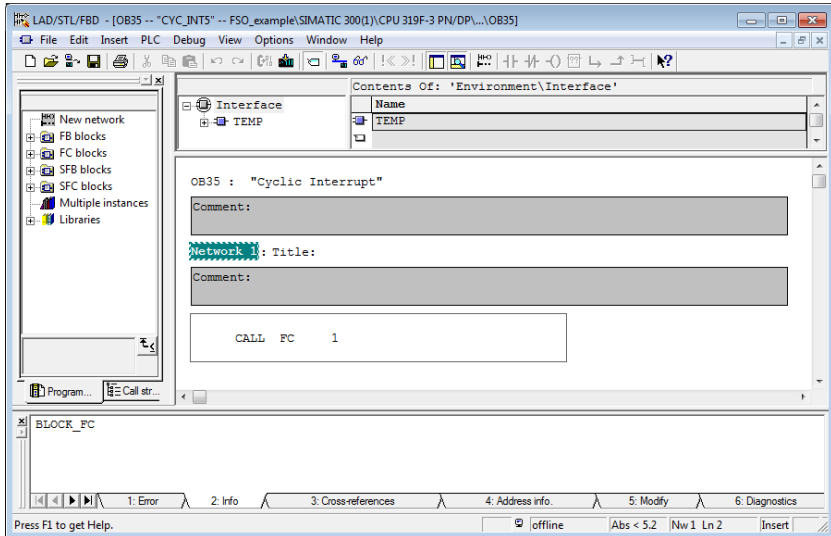

9. In SIMATIC manager, double-click on **FB1**.
10. Add acknowledgement for reintegration by assigning the value of ACK_REQ to ACK_REI in DB2185.

11. Save the block and close the editor.

LAD/STL/FBD - [FB1 -- FSO_example\SIMATIC 300(1)\CPU 319F-3 PN/DP]

File Edit Insert PLC Debug View Options Window Help

Contents Of: 'Environment\Interface'

Name
IN
OUT
IN_OUT
STAT
TEMP

FB1 : FSO simple safety program

Comment:

Network 1: 1=ACKNOWLEDGEMENT FOR REINTEGRATION
PROFIsafe automatic reintergration.

```

DB2185.DBX      0.2
                1=ACKNOWLEDGEMENT FOR REINTEGRATION
                T1
                &
DB2185.DBX      2.2
                1=ACKNOWLEDGEMENT REQUEST
                "P00000_drive1_ABB_PS1".ACK_REQ
                =

```

Network 2 : SLS3 control

Force SLS3 active all the time. Feeding a value and negation of the same value to Exclusive Or evaluates always to TRUE.

```

I1.7           "drive1_SLS3_active"
                XOR
I1.7           "drive1_SLS3_active"
                =
Q1.7           "drive1_SLS3_request"

```

Program... Call str...

Press F1 to get Help. | offline | Abs < 5.2 | Insert

Note: This example program also keeps the SLS3 function active all the time.

12. In SIMATIC Manager, select **Edit safety program** from the **Options** menu.

13. Select **Compile**.

14. Select **Download**. If prompted, accept the inclusion of standard blocks.

15. Switch the controller station to run mode.

Monitoring the PROFIsafe message

It is possible to monitor the contents of the PROFIsafe message. For example:

1. In HW Configuration, select **Monitor/Modify** for the PROFIsafe telegram in Slot 2 of the FENA module.

Online via assigned CPU services

Path: FSO_example\SIMATIC 300(1)\CPU 319F-3 PN/DP

	Symbol	Display format	Status value	Modify value
33	"drive1_VarSLS_active"	BOOL	false	
34	"drive1_POUS_active"	BOOL	false	
35	"drive1_Out_x114_9"	BOOL	false	
36	"drive1_Out_x114_8"	BOOL	false	
37	"drive1_Out_x114_7"	BOOL	false	
38	"drive1_Out_x113_9"	BOOL	false	
39	"drive1_Out_x113_8"	BOOL	false	
40	"drive1_Out_x113_7"	BOOL	false	
41	"drive1_End_ack_req"	BOOL		

Row Not Effective Update Force Symbol with F5

Run conditionally

Monitor

Modify

Trigger...

Run immediately

Status Value

Modify Value

Enable Peripheral Outputs

I/O Display

RUNNING

Close Help

■ Configuring Siemens S7-1200 PLC with TIA14

This example can be done with FENA-21 or FPNO-21 adapter modules.

1. Open TIA14 and create a new project.

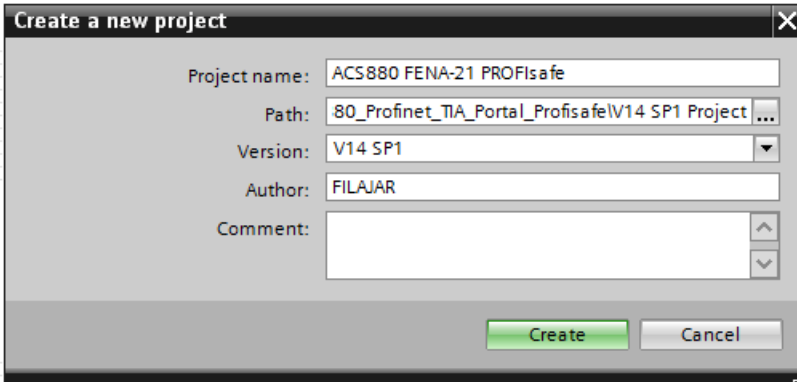

2. Select your CPU from the list.

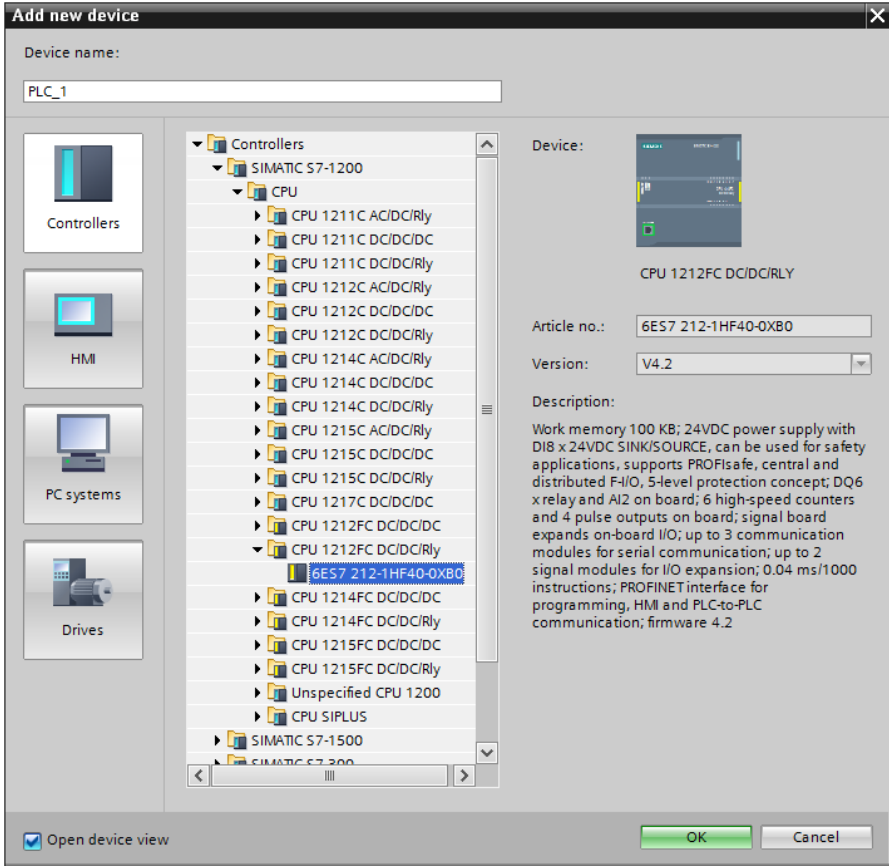

3. Install the FENA-21 GSDML file.

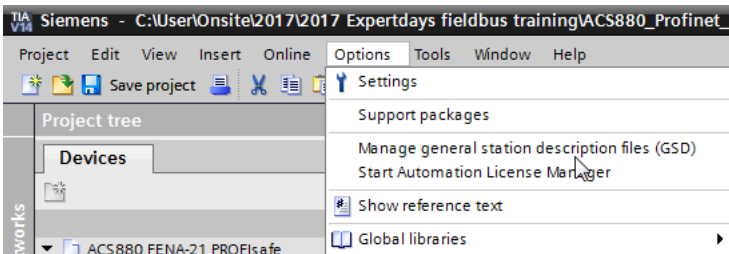

4. Add FENA-21 to the device configuration by dragging it from the hardware catalog.

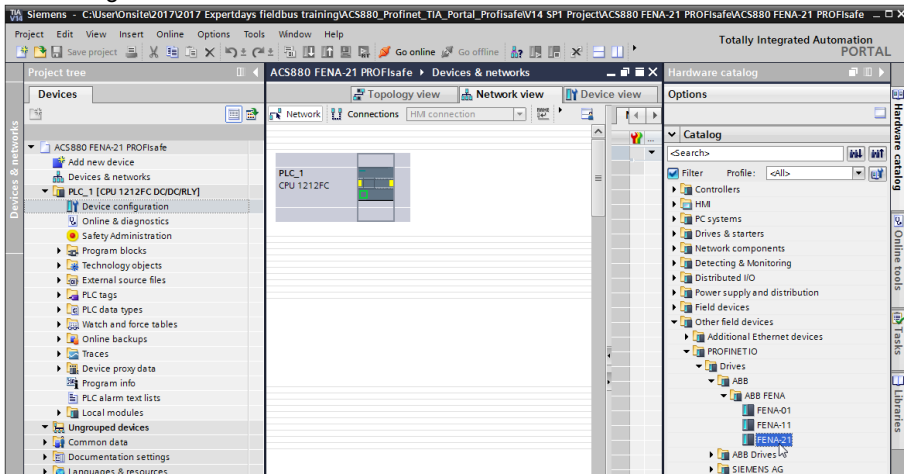

5. Open the FENA-21 device view and add (by dragging and dropping) the desired PPO and PS telegrams to slot 1 and 2. In this example, we use PPO7 and PS2 (Additional info in manuals).

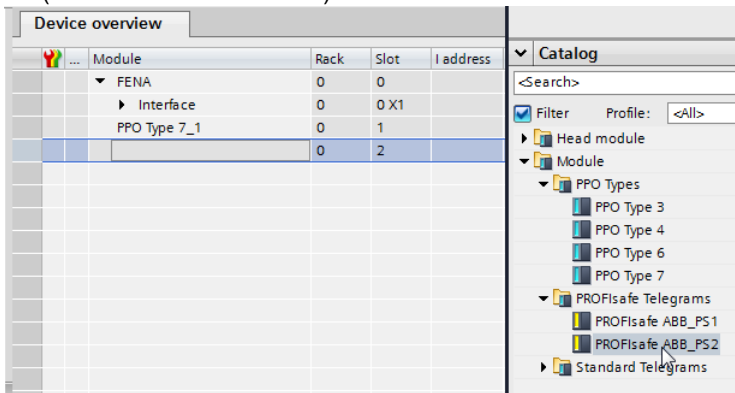

6. **Network view** shows E-stop icon on the FENA device to indicate that device has safety I/O.

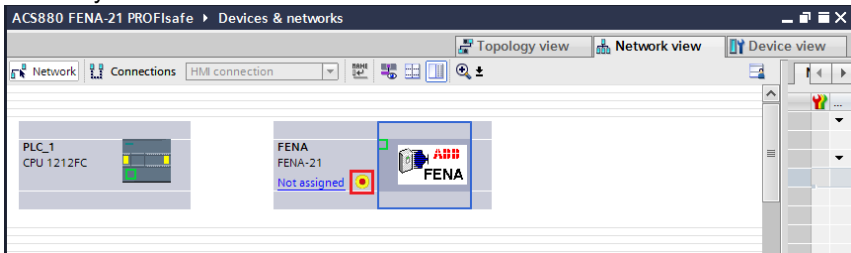

7. Assign FENA-21 to PROFINET controller.

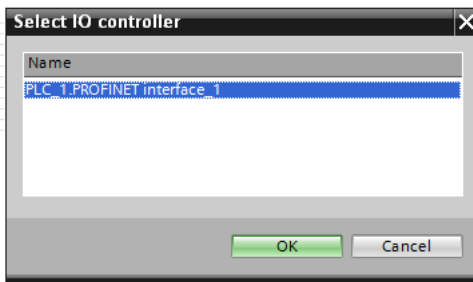
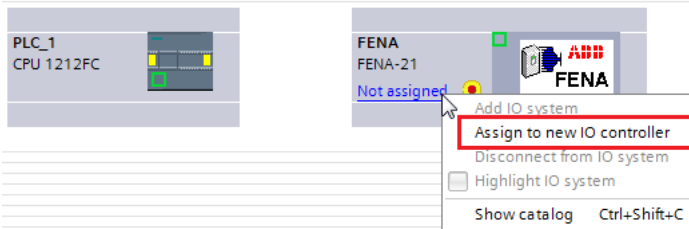

- Network configuration is updated.

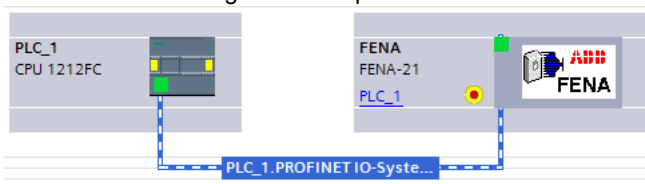

- I/O addressing is assigned automatically to FENA. This can be seen in **Device view** (highlighted with a red box in the image below).

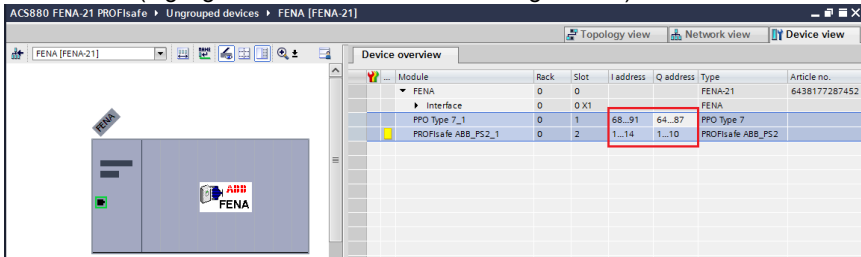

8. Select PLC from network view and Properties will show on the bottom of the screen. In PLC properties, enable F-capability (safety and PROFIsafe) under the **Fail-safe** submenu.

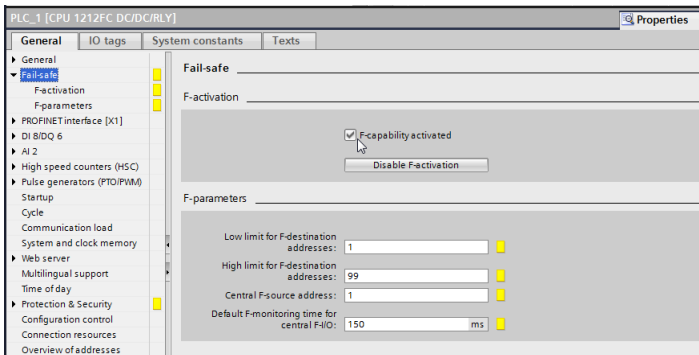

9. In the **F-parameters** submenu, define the maximum allowed safety program execution interval. If this value is exceeded, PROFIsafe goes to safe state (watchdog).

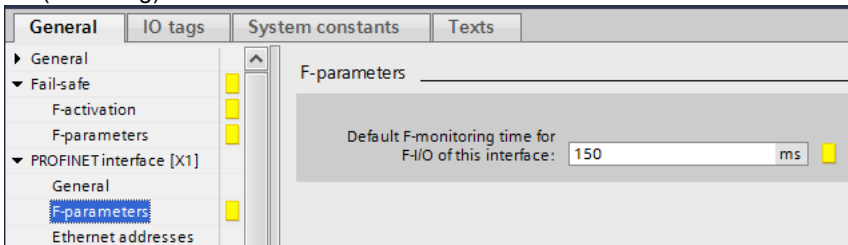

10. In **Ethernet addresses** submenu, set the PLC IP address.

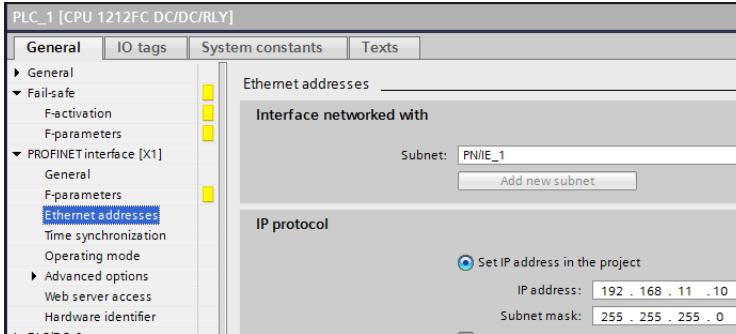

11. In **Advanced options**, set PLC minimum cycle time for I/O and PROFINET communication (PROFINET cycle time).

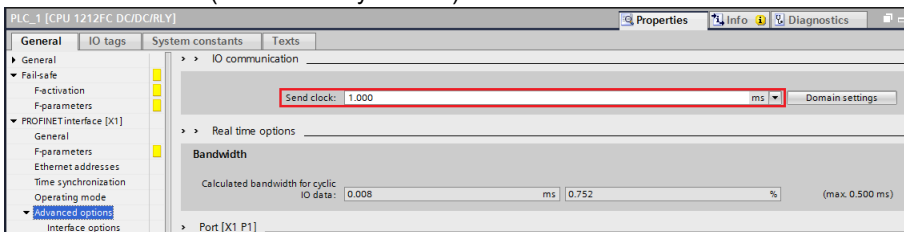

12. For testing purposes, you can disable the PLC password. Remember to enable the PLC password after you have done the validation.

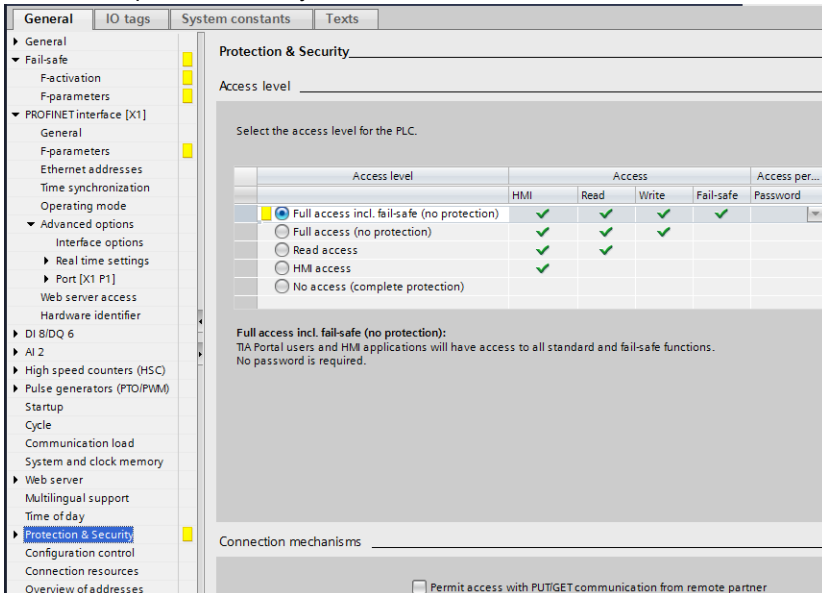

13. In FENA properties, set the FENA-21 IP address and PROFINET device name. The device name will be used as identification. After successful identification, PLC will assign IP address to FENA.

Note: FB module parameters (51.04 onwards) should be static 0.0.0.0 in the drive.

FENA [FENA-21] Properties Info Diagnostics

General IO tags System constants Texts

General

- Catalog information
- PROFINET interface [X1]
 - General
 - Ethernet addresses**
 - Advanced options
 - Interface options
 - Real time settings
 - Port 1 [X1 P1]
 - Port 2 [X1 P2]
 - Hardware identifier
 - Identification & Maintenance
 - Hardware identifier

Ethernet addresses

Interface networked with

Subnet: PNIE_1

Add new subnet

IP protocol

Set IP address in the project

IP address: 192 . 168 . 11 . 2

Subnet mask: 255 . 255 . 255 . 0

Use router

Router address: 0 . 0 . 0 . 0

IP address is set directly at the device

PROFINET

Generate PROFINET device name automatically

PROFINET device name: FENA21-drive

Converted name: fena21-drive

Device number: 1

14. Configure FENA ABB PS PROFIsafe settings:

- F_Source_Add = PLC PROFIsafe address
- F_Dest_Add = FSO PROFIsafe address
- F_WD_Time = Maximum allowed PROFIsafe message cycle time. In this example, we use 200 ms.

The screenshot displays the SIMATIC Manager interface for configuring a PROFIsafe ABB PS module. The top window shows the 'Device overview' table, and the bottom window shows the 'Properties' dialog for 'PROFIsafe ABB_PS2_1'.

Module	Rack	Slot	I ad...
FENA	0	0	
Interface	0	0 X1	
PPO Type 7_1	0	1	68...
PROFIsafe ABB_PS2_1	0	2	1.....

Parameter	Value
F_SIL	SIL3
F_CRC_Length	3-Byte-CRC
F_Par_Version	1
F_Source_Add	1
F_Dest_Add	3
F_Par_CRC_WithoutAddresses	8300
Manual assignment of F-monitoring time	<input checked="" type="checkbox"/>
F_WD_Time	200 ms
F_Par_CRC	19724
F/IO DB manual number assignment	<input type="checkbox"/>
F/IO DB-number	30002
F/IO DB-name	F00001_PROFIsafeABB_PS2_1

15. Add OB86 (Rack or station failure) program block to prevent PLC from stopping on I/O error.

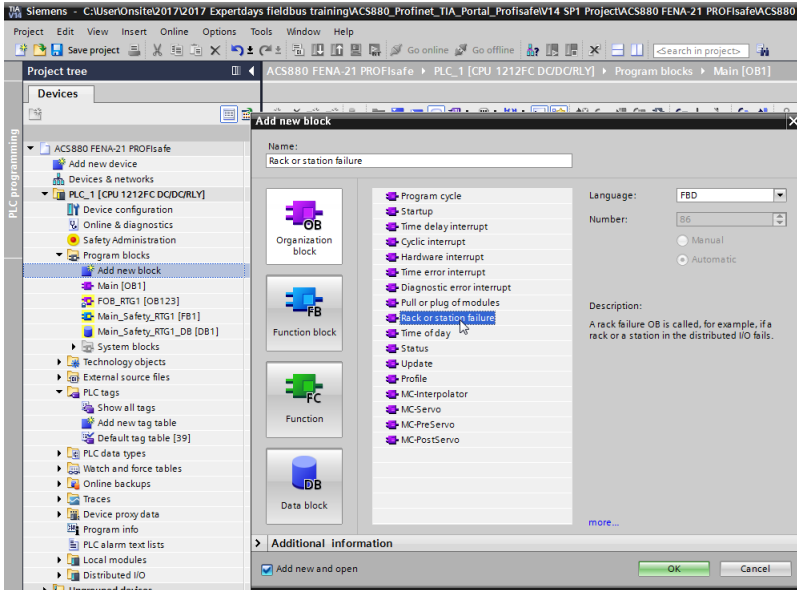

16. Add new Function block "ABB_Drive".

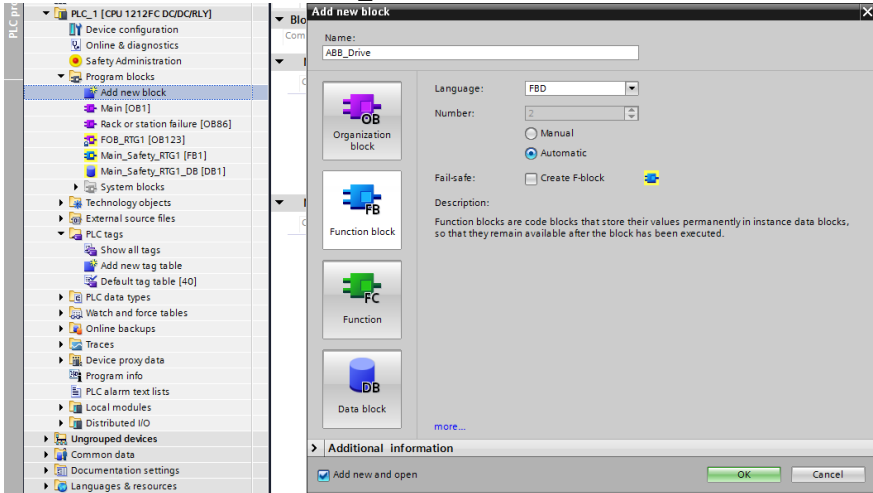

17. Add variables to ABB_Drive FB.

ACS880 FENA-21 PROFIsafe > PLC_1 [CPU 1212FC DC/DCRLY] > Program blocks > ABB_Drive [FB2]

ABB_Drive

	Name	Data type	Default value	Retain	Accessible f...	Writa...	Visible in ...	Setpoint
1	Input							
2	Drive PPO HWADDR FB	HW_SUBMODULE	0	Non-retain	<input checked="" type="checkbox"/>	<input checked="" type="checkbox"/>	<input checked="" type="checkbox"/>	<input type="checkbox"/>
3	Output							
4	<Add new>							
5	InOut							
6	<Add new>							
7	Static							
8	FZD read error	Word	16#0	Non-retain	<input checked="" type="checkbox"/>	<input checked="" type="checkbox"/>	<input checked="" type="checkbox"/>	<input type="checkbox"/>
9	FZD write error	Word	16#0	Non-retain	<input checked="" type="checkbox"/>	<input checked="" type="checkbox"/>	<input checked="" type="checkbox"/>	<input type="checkbox"/>
10	PPO OUT	Struct		Non-retain	<input checked="" type="checkbox"/>	<input checked="" type="checkbox"/>	<input checked="" type="checkbox"/>	<input type="checkbox"/>
11	FZD OUT_1	Word	16#0	Non-retain	<input checked="" type="checkbox"/>	<input checked="" type="checkbox"/>	<input checked="" type="checkbox"/>	<input type="checkbox"/>
12	FZD OUT_2	Word	16#0	Non-retain	<input checked="" type="checkbox"/>	<input checked="" type="checkbox"/>	<input checked="" type="checkbox"/>	<input type="checkbox"/>
13	FZD OUT_3	Word	16#0	Non-retain	<input checked="" type="checkbox"/>	<input checked="" type="checkbox"/>	<input checked="" type="checkbox"/>	<input type="checkbox"/>
14	FZD OUT_4	Word	16#0	Non-retain	<input checked="" type="checkbox"/>	<input checked="" type="checkbox"/>	<input checked="" type="checkbox"/>	<input type="checkbox"/>
15	FZD OUT_5	Word	16#0	Non-retain	<input checked="" type="checkbox"/>	<input checked="" type="checkbox"/>	<input checked="" type="checkbox"/>	<input type="checkbox"/>
16	FZD OUT_6	Word	16#0	Non-retain	<input checked="" type="checkbox"/>	<input checked="" type="checkbox"/>	<input checked="" type="checkbox"/>	<input type="checkbox"/>
17	FZD OUT_7	Word	16#0	Non-retain	<input checked="" type="checkbox"/>	<input checked="" type="checkbox"/>	<input checked="" type="checkbox"/>	<input type="checkbox"/>
18	FZD OUT_8	Word	16#0	Non-retain	<input checked="" type="checkbox"/>	<input checked="" type="checkbox"/>	<input checked="" type="checkbox"/>	<input type="checkbox"/>
19	FZD OUT_9	Word	16#0	Non-retain	<input checked="" type="checkbox"/>	<input checked="" type="checkbox"/>	<input checked="" type="checkbox"/>	<input type="checkbox"/>
20	FZD OUT_10	Word	16#0	Non-retain	<input checked="" type="checkbox"/>	<input checked="" type="checkbox"/>	<input checked="" type="checkbox"/>	<input type="checkbox"/>
21	FZD OUT_11	Word	16#0	Non-retain	<input checked="" type="checkbox"/>	<input checked="" type="checkbox"/>	<input checked="" type="checkbox"/>	<input type="checkbox"/>
22	FZD OUT_12	Word	16#0	Non-retain	<input checked="" type="checkbox"/>	<input checked="" type="checkbox"/>	<input checked="" type="checkbox"/>	<input type="checkbox"/>
23	<Add new>							
24	PPO IN	Struct		Non-retain	<input checked="" type="checkbox"/>	<input checked="" type="checkbox"/>	<input checked="" type="checkbox"/>	<input type="checkbox"/>
25	FZD IN_1	Word	16#0	Non-retain	<input checked="" type="checkbox"/>	<input checked="" type="checkbox"/>	<input checked="" type="checkbox"/>	<input type="checkbox"/>
26	FZD IN_2	Word	16#0	Non-retain	<input checked="" type="checkbox"/>	<input checked="" type="checkbox"/>	<input checked="" type="checkbox"/>	<input type="checkbox"/>
27	FZD IN_3	Word	16#0	Non-retain	<input checked="" type="checkbox"/>	<input checked="" type="checkbox"/>	<input checked="" type="checkbox"/>	<input type="checkbox"/>
28	FZD IN_4	Word	16#0	Non-retain	<input checked="" type="checkbox"/>	<input checked="" type="checkbox"/>	<input checked="" type="checkbox"/>	<input type="checkbox"/>
29	FZD IN_5	Word	16#0	Non-retain	<input checked="" type="checkbox"/>	<input checked="" type="checkbox"/>	<input checked="" type="checkbox"/>	<input type="checkbox"/>
30	FZD IN_6	Word	16#0	Non-retain	<input checked="" type="checkbox"/>	<input checked="" type="checkbox"/>	<input checked="" type="checkbox"/>	<input type="checkbox"/>
31	FZD IN_7	Word	16#0	Non-retain	<input checked="" type="checkbox"/>	<input checked="" type="checkbox"/>	<input checked="" type="checkbox"/>	<input type="checkbox"/>
32	FZD IN_8	Word	16#0	Non-ret...	<input checked="" type="checkbox"/>	<input checked="" type="checkbox"/>	<input checked="" type="checkbox"/>	<input type="checkbox"/>
33	FZD IN_9	Word	16#0	Non-retain	<input checked="" type="checkbox"/>	<input checked="" type="checkbox"/>	<input checked="" type="checkbox"/>	<input type="checkbox"/>
34	FZD IN_10	Word	16#0	Non-retain	<input checked="" type="checkbox"/>	<input checked="" type="checkbox"/>	<input checked="" type="checkbox"/>	<input type="checkbox"/>
35	FZD IN_11	Word	16#0	Non-retain	<input checked="" type="checkbox"/>	<input checked="" type="checkbox"/>	<input checked="" type="checkbox"/>	<input type="checkbox"/>
36	FZD IN_12	Word	16#0	Non-retain	<input checked="" type="checkbox"/>	<input checked="" type="checkbox"/>	<input checked="" type="checkbox"/>	<input type="checkbox"/>

18. Add ABB_Drive FB to OB1. Assign new instance Data Block for ABB_Drive FB.
When using multiple drives, create one DB for each drive.

Call options

 DB
Single instance

Data block

Name: ABB_Drive1_DB

Number: 2

Manual

Automatic

If you call the function block as a single instance, the function block saves its data in its own instance data block.

[more...](#)

OK Cancel

19. Select the corresponding FENA PPO address for the drive HW input.

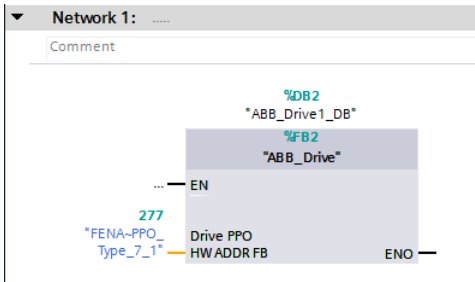
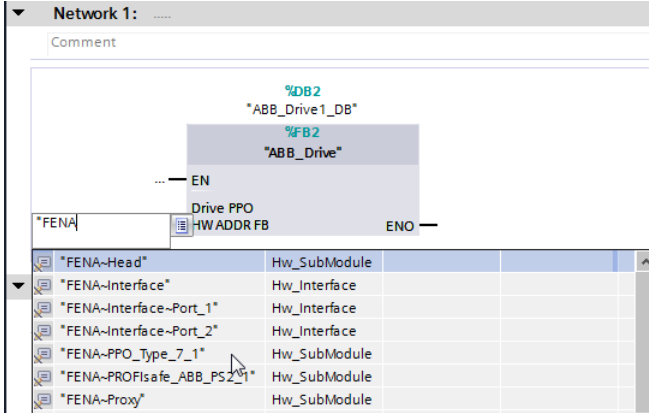

The value can be verified from the HW configuration, in the FENA PPO type properties, under the **Hardware Identifier** tab.

Module	Rack	Slot	Id...
FENA	0	0	
Interface	0	0 X1	
PPO Type 7_1	0	1	68...
PROFIsafe ABB_PS2_1	0	2	1.....

Tab	Hardware identifier
General	
IO tags	
System constants	
Texts	
Hardware identifier	277

20. In ABB_Drive FB, add blocks DPRD_DAT and DPWR_DAT.

The screenshot shows the configuration interface for the ABB Drive Function Block. At the top, there is a toolbar with icons for logical operations: AND (&), OR (>=1), NOT (!), XOR (-o|), and assignment (←=). A mouse cursor is pointing to a block icon with '??' on it. Below the toolbar, the 'Block title' and 'Comment' fields are visible. The main area shows 'Network 1' with a comment field and a diagram of a block with 'IN' and 'OUT' terminals. Below this, a red 'X' icon indicates an error in 'Network 1: Read and write cyclic data from drive'. The error details show two blocks, DPRD_DAT and DPWR_DAT, with their respective inputs and outputs. Red arrows point to the RET_VAL and RECORD outputs of DPRD_DAT and the RET_VAL output of DPWR_DAT, which are marked with '???'.

Network 1: Read and write cyclic data from drive

Comment

DPRD_DAT

... EN RET_VAL <???

<???

LADDR RECORD <???

ENO

DPWR_DAT

... EN RET_VAL <???

<???

LADDR RECORD <???

ENO

21. Insert values to blocks.

The screenshot shows the configuration interface for the ABB Drive Function Block. The 'Network 1' title is 'Read and write PPO message data'. The 'Comment' field is empty. The main area shows two blocks, DPRD_DAT and DPWR_DAT, with their respective inputs and outputs. The inputs and outputs are now populated with specific values: EN, LADDR, and RECORD for both blocks; RET_VAL and ENO for DPRD_DAT; and RET_VAL and ENO for DPWR_DAT. The values are: "#*Drive PPO HW ADDR FB*" for EN and LADDR; "#*PZD read error*" for RET_VAL; "#*PPO IN*" for RECORD; and "#*PZD write error*" for RET_VAL.

Network 1: Read and write PPO message data

Comment

DPRD_DAT

... EN RET_VAL "#*PZD read error"

#*Drive PPO RECORD "#*PPO IN"

HW ADDR FB" LADDR ENO

DPWR_DAT

... EN RET_VAL "#*PZD write error"

#*Drive PPO RECORD

HW ADDR FB" ENO

#*PPO OUT"

Later the PPO message data can be found in ABB_Drive1_DB.

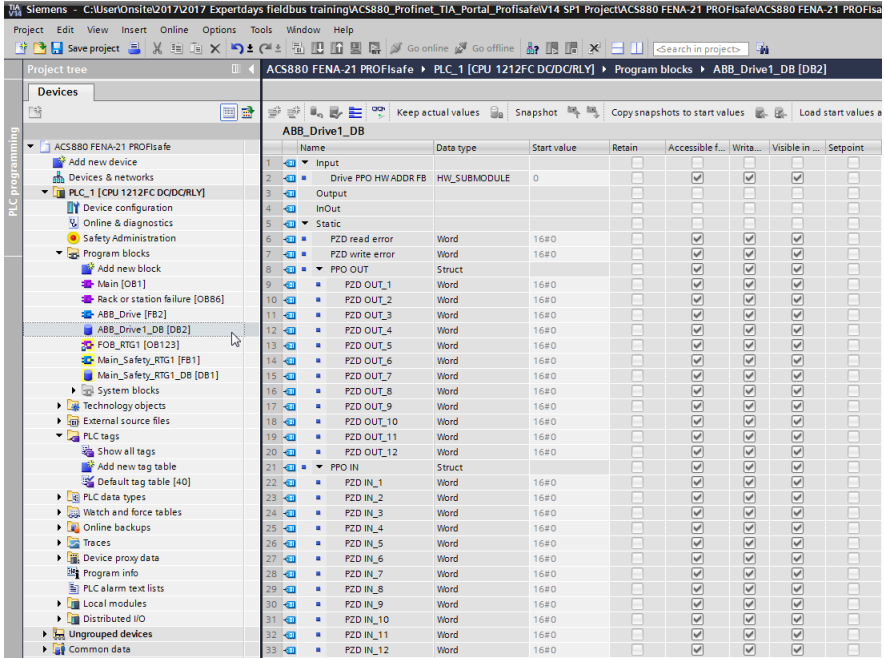

22. In PLC Safety Administration, configure F-runtime group cycle time, warn and maximum cycle time limits. If maximum limit is exceeded, PLC will go to safe state.

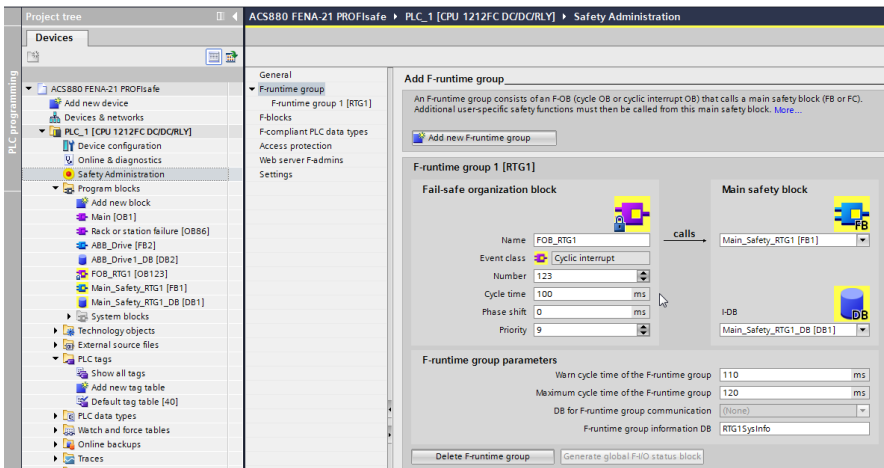

23. Create tag table for ABB_PS2 safety functions. See bit descriptions from FSO PROFIsafe profiles (Chapter 6). See correct I/O addresses from HW configuration.

| Device overview | | | | | | |
|---------------------|------|------|-----------|-----------|-------------------|--|
| Module | Rack | Slot | I address | Q address | Type | |
| ▼ FENA | 0 | 0 | | | FENA-21 | |
| ▶ Interface | 0 | 0 X1 | | | FENA | |
| PPO Type 7_1 | 0 | 1 | 68...91 | 64...87 | PPO Type 7 | |
| PROFIsafe ABB_PS2_1 | 0 | 2 | 1...14 | 1...10 | PROFIsafe ABB_PS2 | |

| Project tree | | ACS880 FENA-21 PROFIsafe ▶ PLC_1 [CPU 1212FC DC/DC/RLY] ▶ PLC | | | |
|--------------|--------------------|---|---------|--|--|
| Devices | | Drive1 ABB PS2 | | | |
| | Name | Data type | Address | | |
| 1 | Drive1_SLS2_active | Bool | %I1.0 | | |
| 2 | Drive1_SLS1_active | Bool | %I1.1 | | |
| 3 | Drive1_Tag_3 | Bool | %I1.2 | | |
| 4 | Drive1_Tag_4 | Bool | %I1.3 | | |
| 5 | Drive1_SS1_active | Bool | %I1.4 | | |
| 6 | Drive1_SSE_active | Bool | %I1.5 | | |
| 7 | Drive1_SBC_active | Bool | %I1.6 | | |
| 8 | Drive1_STO_active | Bool | %I1.7 | | |
| 9 | Drive1_Tag_9 | Bool | %I2.0 | | |
| 10 | Drive1_Tag_10 | Bool | %I2.1 | | |
| 11 | Drive1_Tag_11 | Bool | %I2.2 | | |
| 12 | Drive1_Tag_12 | Bool | %I2.3 | | |
| 13 | Drive1_SAR1_active | Bool | %I2.4 | | |

24. Save and download project to PLC.

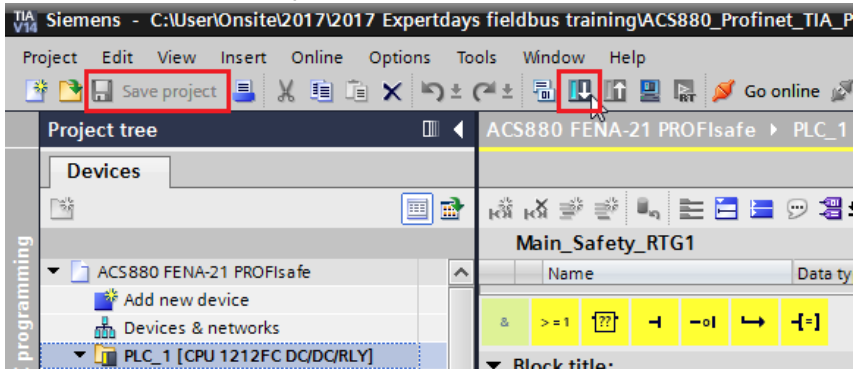

25. Scan for accessible devices (start search). Note that a firewall can block traffic.

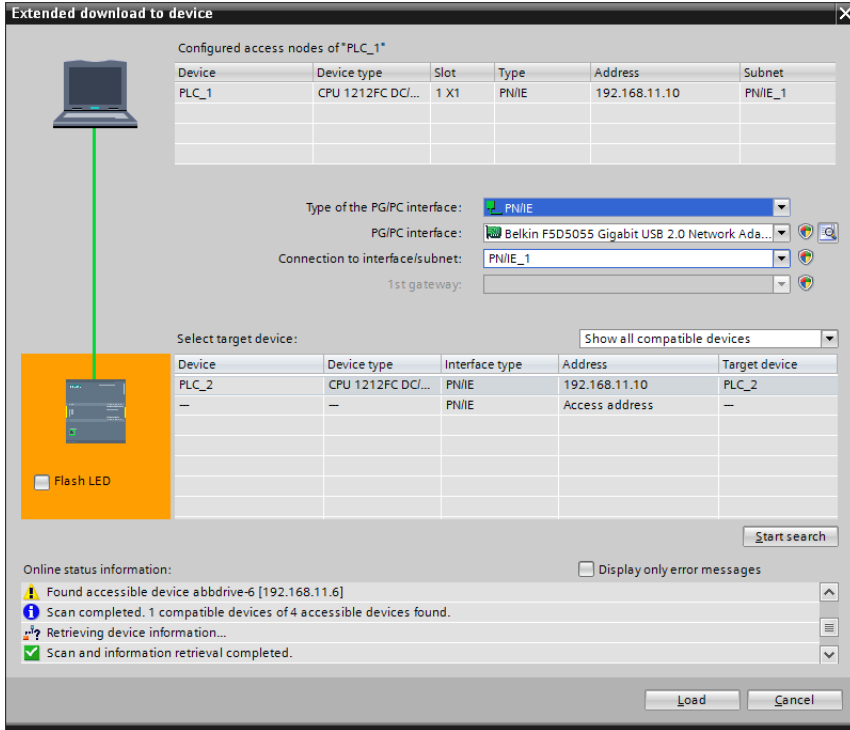

26. In device configuration, right-click FENA icon and select **Assign device name**.

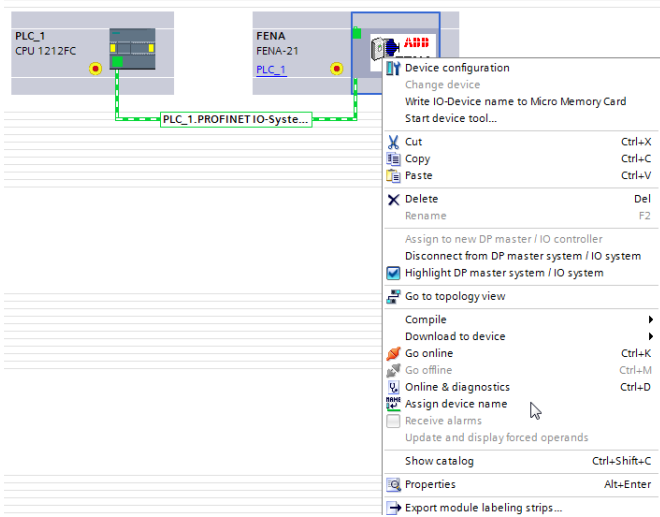

27. Select update list and identify the correct FENA-based on MAC ID label. Click **Assign name**.

Note: The MAC ID can be found on the cover of the FB module.

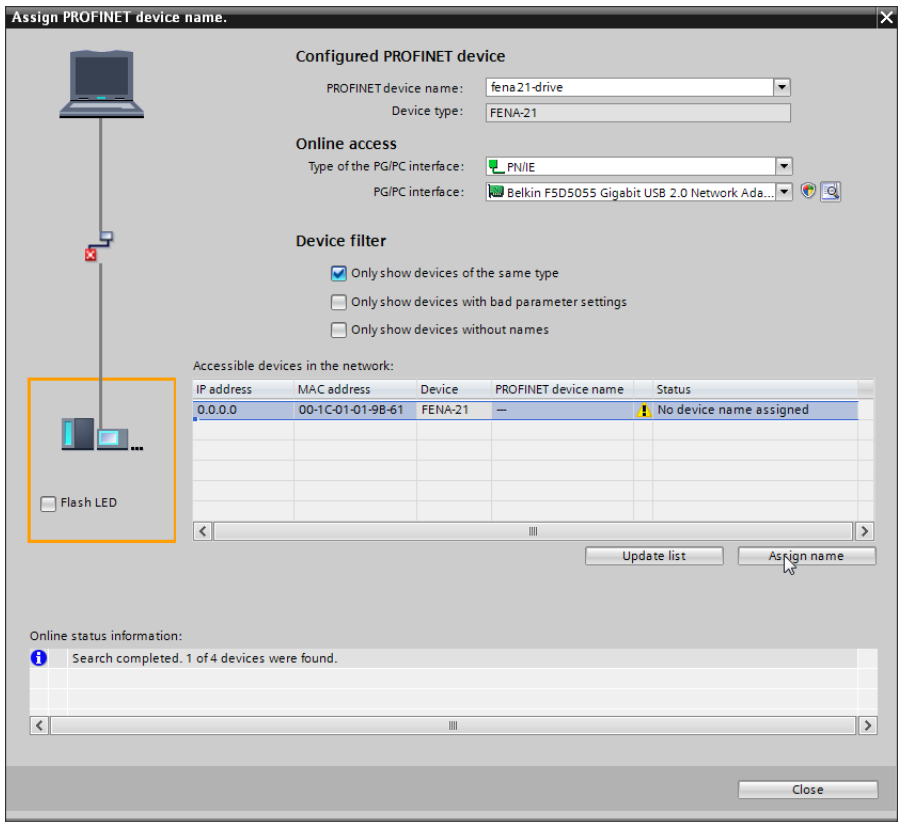

The PLC will assign a name and IP address to the selected FENA and drive parameter group 51 values will update accordingly.

| 51. FBA A settings | | |
|--------------------|------------------|---------------------|
| 1 | FBA A type | Ethernet NoUnit |
| 2 | Protocol/Profile | PNIO ABB Pro NoUnit |
| 3 | Commrate | Auto NoUnit |
| 4 | IP configuration | Temp IP NoUnit |
| 5 | IP address 1 | 192 NoUnit |
| 6 | IP address 2 | 168 NoUnit |
| 7 | IP address 3 | 11 NoUnit |
| 8 | IP address 4 | 2 NoUnit |
| 9 | Subnet CIDR | 24 NoUnit |
| 10 | GW address 1 | 192 NoUnit |
| 11 | GW address 2 | 168 NoUnit |
| 12 | GW address 3 | 11 NoUnit |
| 13 | GW address 4 | 2 NoUnit |

Fault tracing

■ Reading diagnostic messages

You can read the PROFIsafe diagnostics messages from:

1. the Event logger of the Drive Composer pro PC tool,
2. the Event log of the ACS-AP-x assistant control panel and
3. the error buffers of the PLC system. In this case, make sure that drive parameter *51.21* is set to *Enabled* (see the drive firmware manual).

ABB AC500-S

In the ABB AC500-S system, you can read PROFINET diagnostics messages from Control Builder Plus or with a separate PNIO_DEV_DIAG function block in the “non-safety” PLC program.

To read the alarm data of the last active alarm from Control Builder Plus:

1. Select **FENA_21**.
 2. On the **Diagnostics for Profinet slave** tab, select **Refresh** to read diagnostics messages.
-

SIMATIC Manager

To read diagnostics messages:

1. In the **PLC** menu, select **Diagnostic/Setting**.
2. Select **Hardware diagnostics**.
3. In the window that opens, select the FENA module of your system.
4. Click the **Module Information** button.

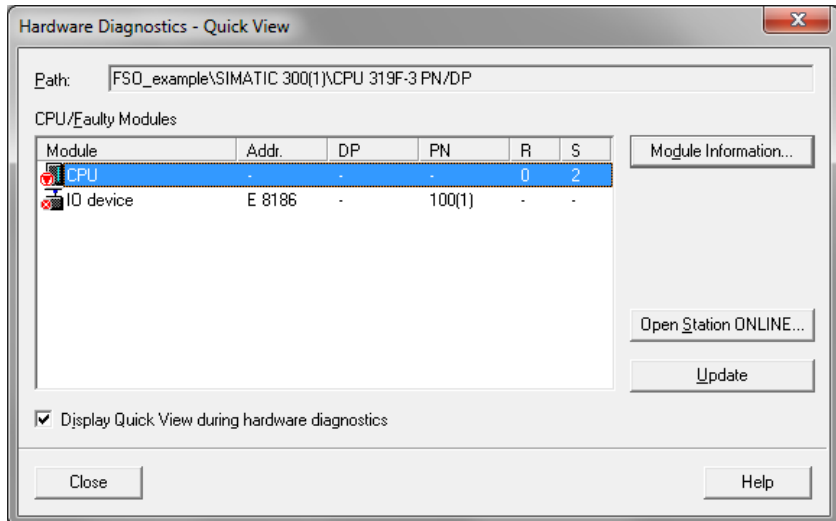

5. To read the diagnostic messages, select the **I/O Device Diagnostics** tab.

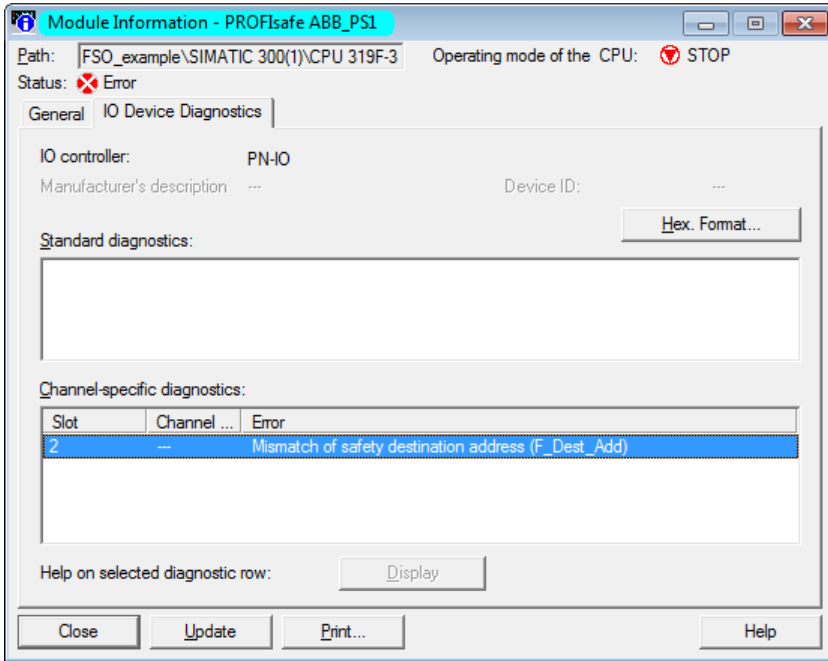

6. To check the Device number of the FENA module, select the **General** tab.

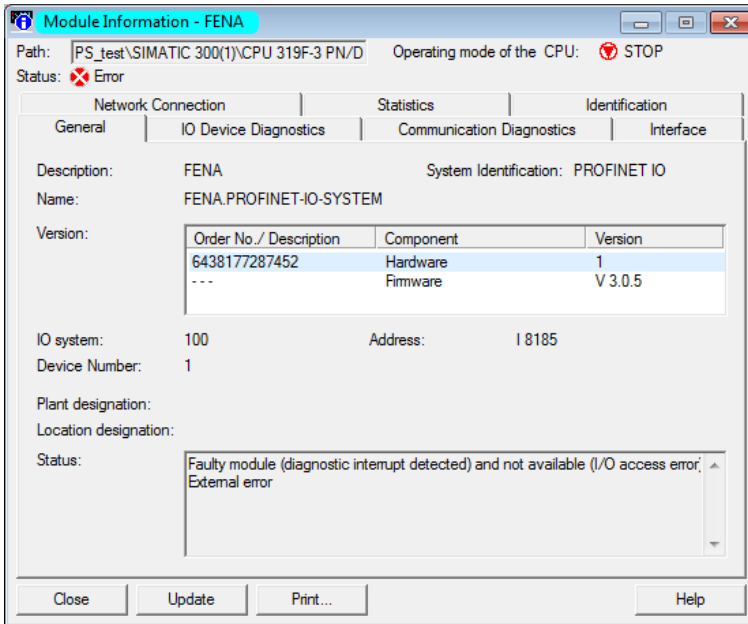

■ Diagnostic messages related to F-Parameters

The diagnostics messages in this table are caused by problems in the F-Parameter processing that takes place only when the controller station sends the F-Parameters to FB module. This happens normally only when the controller station starts up the PROFINET communication with the FB module.

| Value (hex) | Description | Notes |
|-------------|---|---|
| 64 (0x0040) | Mismatch of safety destination address (F_Dest_Add). | F_Dest_Add did not match the value configured in the safety parameters (PROFIsafe.11 PROFIsafe F_Dest_Add). |
| 65 (0x0041) | Safety destination address is not valid (F_Dest_Add). | F_Dest_Add of 0 or FFFFh is not allowed. A valid F_Dest_Add is within range 1...65534. |
| 66 (0x0042) | Safety source address is not valid (F_Source_Add). | F_Source_Add of 0 or FFFFh is not allowed. A valid F_Source_Add is within range 1...65534. |
| 67 (0x0043) | Safety watchdog time value is 0 ms (F_WD_Time). | Watchdog time 0 ms is not allowed. A valid F_WD_Time is within range 1...65535. |

| Value (hex) | Description | Notes |
|-------------|---|---|
| 68 (0x0044) | Parameter "F_SIL" exceeds SIL from specific device application. | F_SIL defined for this device at F-Host is not correct. This device supports only F_SIL = 3. |
| 69 (0x0045) | Parameter "F_CRC_Length" does not match the generated values. | F-Parameter checksum length different from 3 octets. This device supports only three (3) octet CRC2. |
| 70 (0x0046) | Parameter "F_Par_Version" set incorrectly. | Version of F-Parameter defined for this device at F-Host is not correct. This device supports only V2. |
| 71 (0x0047) | CRC1 Fault | Checksum CRC1 calculated over the F-Parameters does not match the checksum value in the F-Parameters. |
| 72 (0x0048) | Device-specific diagnosis information | Unsupported PROFINET submodule identification number received from the controller station upon PROFINET connection, or general error in the F-Parameters. |

■ Typical communication errors

This table lists some typical error situations in the PROFINET and PROFIsafe communication.

| Fault | Cause | What to do |
|--|--|---|
| You cannot start the PROFINET communication. | The FB module station name saved in the FB module does not match the station name of the FB module in the PLC configuration. | Check the station names in both places. |
| | The FB module IP address saved in the FB module does not match the IP address of the FB module in the PLC configuration. | Check the IP settings in both places. |
| | The FB module is not configured for the PROFINET communication. | Check drive parameter <i>51.01</i> or <i>54.01</i> . See the FB module user's manual for details. |

| Fault | Cause | What to do |
|---|--|---|
| You cannot start the PROFIsafe communication. | The drive safety parameters are not set correctly. | In the ACS880/DCS880 drives, check the values of parameters 200.222 Safety bus type and 200.223 Safety fieldbus adapter slot . See section How to configure the safety communication with PROFIsafe on page 320 for details. |
| | The PROFIsafe destination address of the FB module does not match the station name of the FB module in the PLC configuration. | In the ACS880/DCS880 drives, check the value of parameter PROFIsafe.11 PROFIsafe F_Dest_Add . See section How to configure the safety communication with PROFIsafe on page 320 for details. |
| PROFIsafe communication watchdog time exceeds often. | The watchdog time is too short. | Calculate a new watchdog time. See section Calculating the watchdog time on page 229 . |
| All errors solved but you still cannot start the PROFIsafe communication. | After you have modified the configuration of the safety devices, you may have to reboot the whole system before the changes take effect. | <p>Reboot the safety PLC.</p> <p>If this does not help, reboot also the FSO module, the FB module and the drive.</p> <p>To reboot the FSO module:</p> <ul style="list-style-type: none"> • switch the power off and on, or • use drive parameter <i>FSO reboot</i> (parameter 96.09, see the drive firmware manual). <p>To reboot the FB module:</p> <ul style="list-style-type: none"> • switch the power off and on, or • use drive parameter <i>FBA A/B PAR REFRESH</i> (parameter 51.27/54.27, see the drive firmware manual). <p>To reboot the drive:</p> <ul style="list-style-type: none"> • switch the power off and on, or • use drive parameter <i>Control board boot</i> (parameter 96.08, see the drive firmware manual). |



Planning for installation

Contents of this chapter

This chapter gives instructions and references to instructions in other manuals for planning the safety system installation, as well as the requirements for installation in the applicable safety standards.

Requirements for designers and installers

- Designers and installers must be trained to understand the requirements and principles of designing and installing safety-related systems.
- Designers and maintainers must be trained to understand the causes and consequences of Common Cause Failures (CCF). See the checklist for the appropriate standard in section [Checklists](#) on page 307.

Mechanical installation

■ Installation site

The subsystem elements must always be likely to operate within the range of temperature, humidity, corrosion, dust, vibration, etc. for which they are specified, without the use of external environmental control (see section [Ambient conditions](#) on page 520).

The FSO and FSE modules must only be used in an environment where no conductive dust or contaminants are present. One way to ensure proper protection against contamination is to use the FSO and FSE modules in at least an IP54 enclosure. For further information on environmental limits, see chapter *Planning the mechanical installation* in the drive hardware manual.

⚠ WARNING! If you operate the drive system with a safety module in environmental conditions that are outside of the specified ranges for the safety module, this can cause that a safety function is lost.

Electrical installation

■ General requirements

Electrical installation of the safety system must be performed according to the practices outlined in chapter *Planning the electrical installation* in the drive hardware manual.

Chapter *Installation checklists* provides additional advice for the planning.

All wiring must be well protected, routed and clamped where practicable.

When installing cabling it must be assured that there is no pulling or pinching on the cables.

■ Connections

Inputs and outputs

To design the safety system architecture and select components to be used, it is essential to read and understand the different architecture options (for example single channel / redundancy).

Single inputs can be connected to any terminal X113:1...4 or X114:1...4.

Redundant inputs must be connected so that one input is connected to X113:n, and the other is connected to X114:n (n = 1...4; the same for both inputs).

Use diagnostic pulse TP1 (X113:10) for the X113 inputs and TP2 (X114:10) for the X114 inputs.

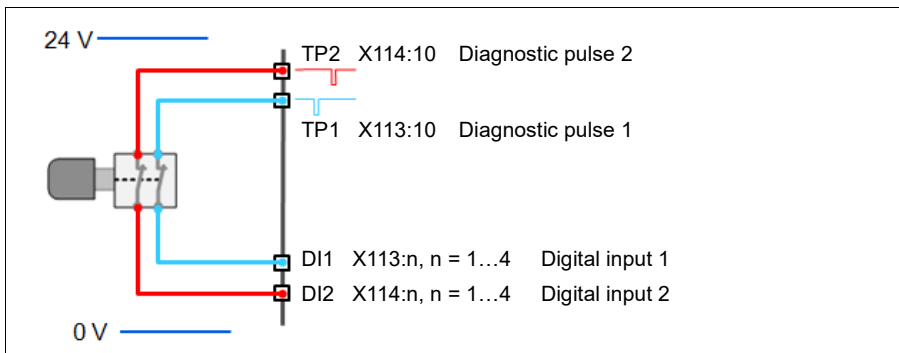

Note: You can use calculation software to assist in selecting the appropriate architecture that will meet the safety integrity requirements for a particular application. Use, for example, ABB's Functional safety design tool, see *Functional safety design tool user's manual* (3AXD10000102417 [English]).

■ STO cable and data cable between FSO module and drive

For the specifications, see [STO cable and data cable between FSO module and drive](#) on page 519.

■ Power supply connection/cables

The system must be protected against over-voltage and over-current.

The length of the cabling between the FSO and its power supply must be three meters or shorter, or a sufficiently low interference level must be otherwise guaranteed.

Note: The 24 V DC power supply should be equipped with a supply disconnecting device to enable an easy start-up of the FSO module.

Note: The FSO module power input (X112) is protected against over-voltage, under-voltage and over-current, and it has a reverse polarity protection. FSO module enters Fail-safe mode if any of these protections trip. The module enters Fail-safe mode also if output voltages of the internal power supply are outside specified limits due to supply input over-voltage.

Note: If you de-energize the FSO module, you cannot operate the drive.

■ Power supply for the FSE module and safety encoders

You have to use the same power supply for the FSE and FSO modules. The length of the cabling between the FSE and the power supply must be no more than three meters, or a sufficiently low interference level must otherwise be guaranteed. For more information, see *FSE-31 pulse encoder interface module user's manual* (3AXD50000016597 [English]).

If an internal safety encoder failure occurs, the safety encoder goes into the Safe state. To recover from these situations, you have to be able to reboot the safety encoder (for example, by switching the power off and on).

If FSE module goes to power-down mode while FSO is in power-on mode, FSO will activate STO and indicate Fail-safe state.

■ Ensuring the EMC compatibility

The system must only be used in the EMC environment it is designed for, or necessary mitigations must be applied.

■ **Selecting control cables**

All control cables must be shielded. Use double-shielded twisted pair cable for low voltage digital signals (control cables to on-field devices). An alternative solution is to use single-shielded twisted multi-pair cable.

See section [Control connection data](#) on page 518 and chapter *Planning the electrical installation* in the drive hardware manual.

■ **Routing the cables**

See chapter *Planning the electrical installation* in the drive hardware manual. Obey especially these rules:

- When using redundant signaling, take care to avoid common cause failures in the cables. This can be done by routing the two channels through two well-apart routes, or by protecting the cabling appropriately, for example by using double-shielded cables.
 - Never mix 24V-level signals with non-ELV-signals or power feeds in the same cable.
 - Safety Related Electronic Control System (SRECS) signal cables for the individual channels must be routed separately from the other channels at all positions or sufficiently shielded.
 - SRECS signal and electrical energy power cables must be separated at all positions or sufficiently shielded.
 - Cross-connection between the channels of the subsystem must be prevented.
 - Signal paths must be physically separated (for example, separation in wiring).
-

■ Standard function and wiring examples

Passive switch

Examples:

- Limit switch
- Emergency stop button

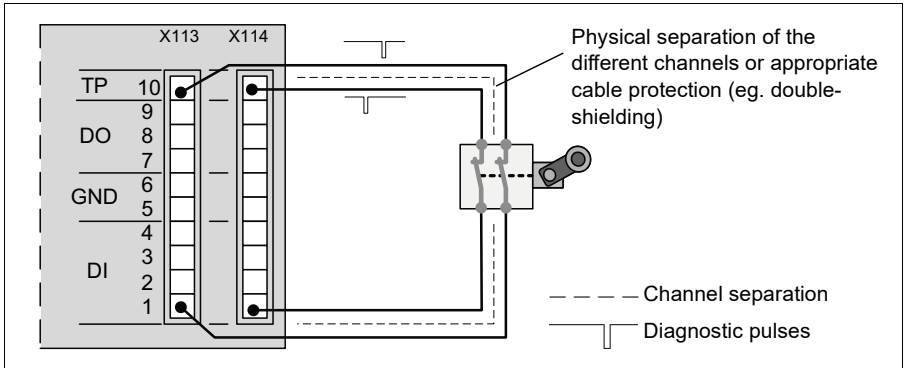

Relay / contactor output with feedback

Examples:

- Brake control
- Door/gate unlock

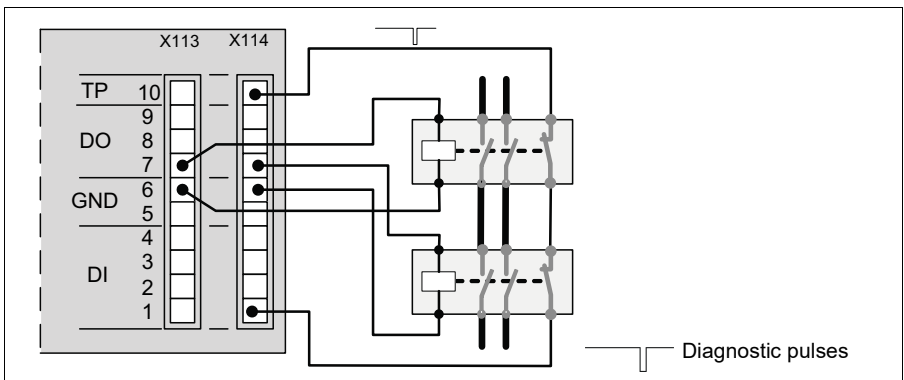

Safe brake control (SBC)

In this figure normal and safe brake controls are connected in series. Both are independent and redundant 2-channel solutions.

The safe brake control needs a feedback from the brake system. The SBC feedback can be from a relay/contact or from the mechanical brake itself.

Note: If also the drive can control the brake, the feedback must not be from the mechanical brake.

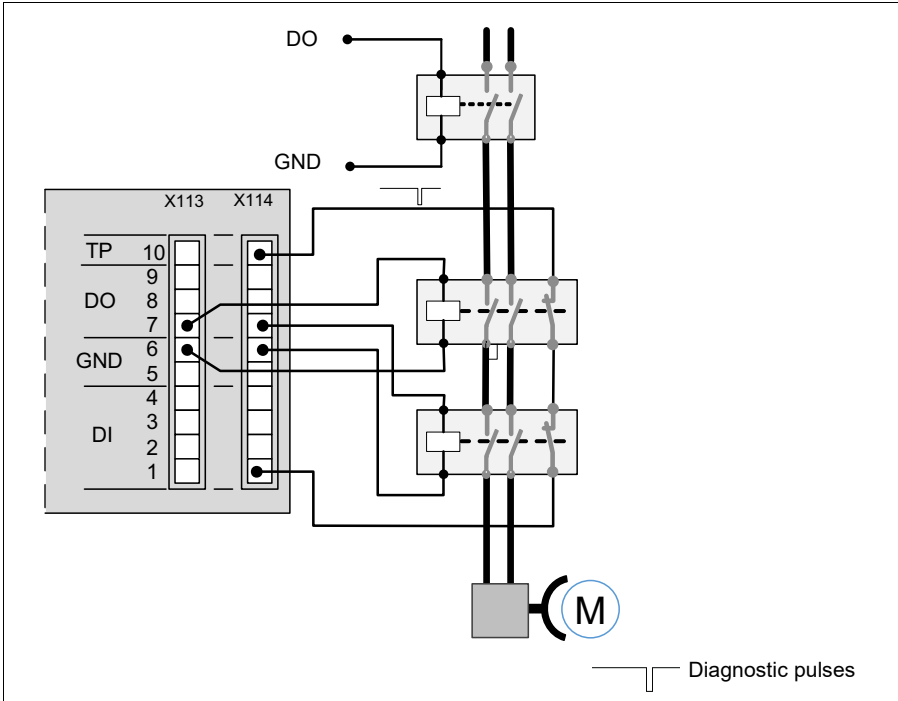

Active sensors / input signals from solid state devices

Examples:

- PLC 24 V DC PNP
- Light curtain OSSD

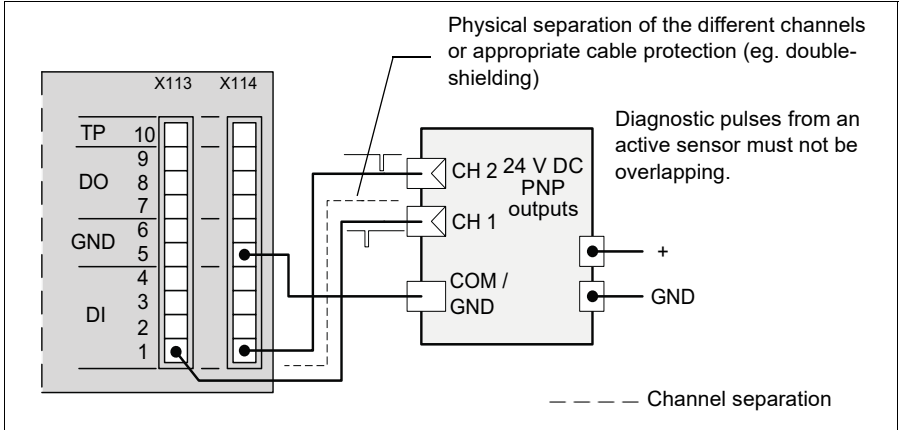

Outputs to solid state devices

Example:

- PLC 24 V DC NPN

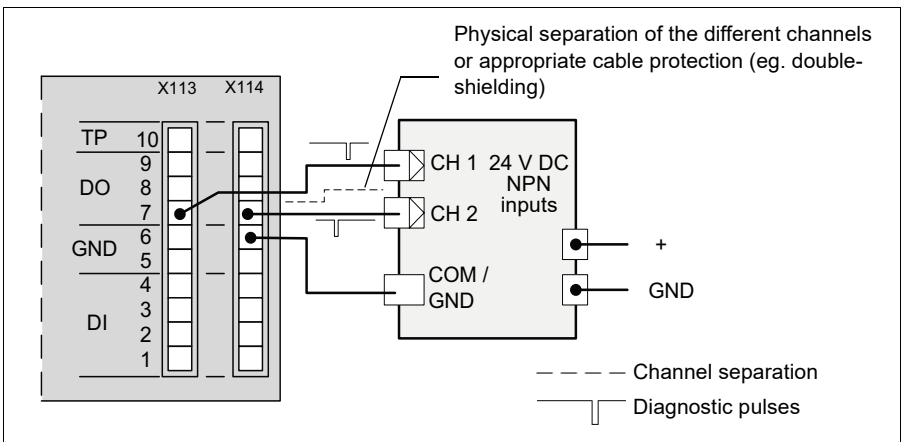

Cascade

Example:

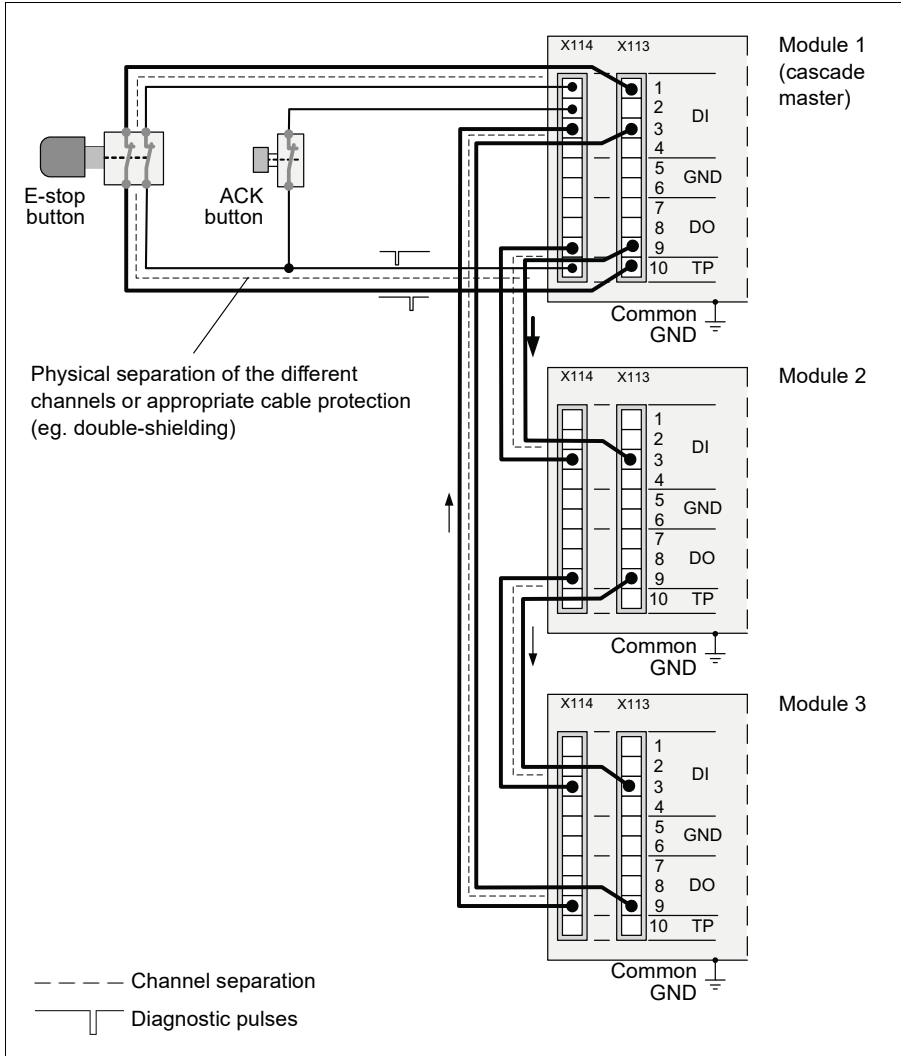

8

Installation

Contents of this chapter

This chapter gives examples of how to connect the FSO module to the ACS880/DCS880 drive.



WARNING! Connect the FSO module to a 24 V DC power supply. If you connect it to a power supply with a higher voltage (for example, 115 V or 230 V), it will cause damage to the module. If this occurs, the module must be replaced.



Unpacking

If you have ordered the FSO module option separately, it is delivered in its own package. The package contains:

- the FSO module (1)
- connector plugs and attachment screws (2)
- 2 × FSO data cable, 220 mm and 85 mm (3)
- 2 × STO cable, 220 mm and 400 mm (4)
- connector for the power supply wires (5)
- mounting plate for ZCU-14 (6). The default mounting plate for ZCU-12 is attached to the module.
- user's manual (not shown in the figure).



Examining the delivery

Make sure that all parts are in the package and that there are no signs of damage. Notify the shipper immediately if you find damaged parts. Do not use damaged parts, they must be replaced.

Make sure that the FSO module is of the correct type. Refer to [Type designation label](#) on page 39.

Mechanical installation

If you have ordered the FSO module option with the drive, it is delivered with the FSO already installed and the FSO data cable connected. In this case, continue with [Electrical installation](#) on page [301](#).

If you have ordered the FSO module option separately, it is delivered in its own package and you must install it to the drive control unit.

Do not install the FSO module on a FEA-03 F-series extension adapter.

If necessary, remove the default mounting plate from the FSO module and replace it with the other mounting plate in the package.

You can install the FSO module:

- onto the control unit
- adjacent to the control unit.

If you do not install the module directly onto the control unit, make sure that the module is correctly grounded. For the requirements of the STO cable and data cable, refer to [STO cable and data cable between FSO module and drive](#) on page [519](#).

■ Installing the module onto a BCU control unit

Install the FSO mechanically onto the control unit as described in the drive or inverter unit hardware manual and *BCU-02/12/22 control units hardware manual* (3AUA0000113605 [English]). For the tightening torques, refer to [Tightening torques](#) on page [519](#).



■ Installing the module onto a ZCU control unit

Install the FSO mechanically onto the control unit as described in the drive hardware manual. For the tightening torques, refer to [Tightening torques](#) on page 519.

Examples are shown below:

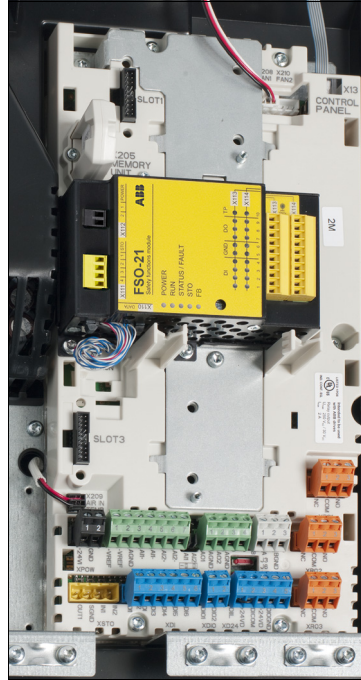

Electrical installation

■ Terminals

The connections are shown in the figure below.

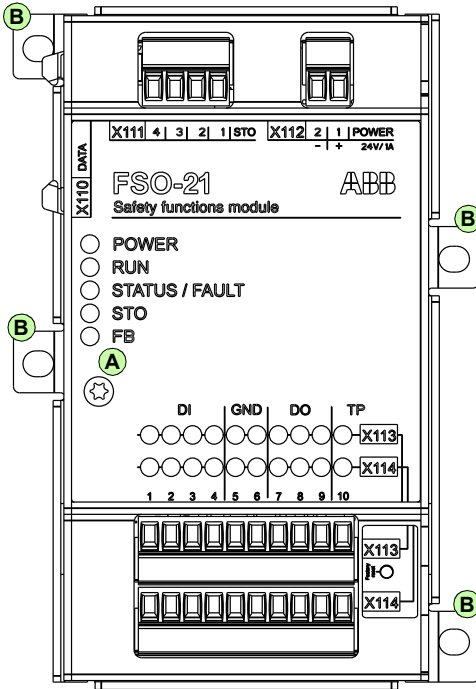

| | |
|---|--|
| A | Electronics grounding screw |
| B | Enclosure grounding screw, at any of the mounting points, depending on the installation type |

| X110: | | |
|-------|------|---|
| | DATA | Data connection to the drive control unit |

| X111: | | |
|-------|-----|------------------------------|
| 1 | STO | STO 24 V |
| 2 | STO | STO ground |
| 3 | STO | STO1LO drive internal signal |
| 4 | STO | STO2LO drive internal signal |

| X112: | | |
|-------|-------|------|
| 1 | POWER | 24 V |
| 2 | POWER | 0 V |

| X113: | | |
|-------|-----|--------------------------------|
| 1 | DI | Channel 1 digital input 1 |
| 2 | DI | Channel 1 digital input 2 |
| 3 | DI | Channel 1 digital input 3 |
| 4 | DI | Channel 1 digital input 4 |
| 5 | GND | Signal ground |
| 6 | GND | Signal ground |
| 7 | DO | Channel 1 digital output 1 |
| 8 | DO | Channel 1 digital output 2 |
| 9 | DO | Channel 1 digital output 3 |
| 10 | TP | Channel 1 diagnostic pulse out |

| X114: | | |
|-------|-----|--------------------------------|
| 1 | DI | Channel 2 digital input 1 |
| 2 | DI | Channel 2 digital input 2 |
| 3 | DI | Channel 2 digital input 3 |
| 4 | DI | Channel 2 digital input 4 |
| 5 | GND | Signal ground |
| 6 | GND | Signal ground |
| 7 | DO | Channel 2 digital output 1 |
| 8 | DO | Channel 2 digital output 2 |
| 9 | DO | Channel 2 digital output 3 |
| 10 | TP | Channel 2 diagnostic pulse out |

Note: The signal grounds (X113:5, X113:6, X114:5, X114:6) are not suitable for grounding the cable shields.



■ Connection procedure



WARNING! Obey the safety instructions. See chapter [Safety instructions](#) on page 13. If you ignore them, injury or death can occur.

1. Stop the drive and do the steps in section [Electrical safety precautions](#) on page 14 before you start the work.
2. Make sure that the FSO electronics grounding screw is correctly tightened. See section [Tightening torques](#) on page 519.
3. Make sure that the enclosure grounding screw is correctly tightened. Use T10 head. See section [Tightening torques](#) on page 519.

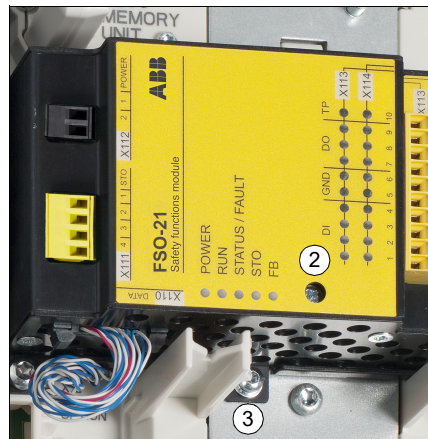
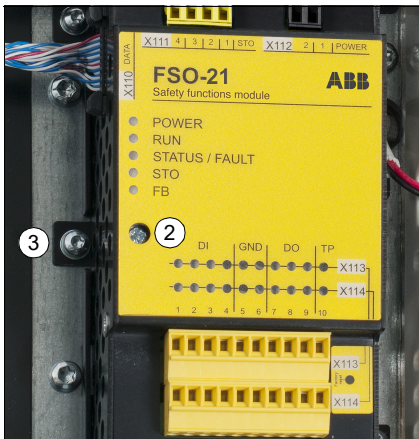

4. Make sure that the FSO data cable (terminal X110) is connected to the drive. Use only the cable delivered with the module.

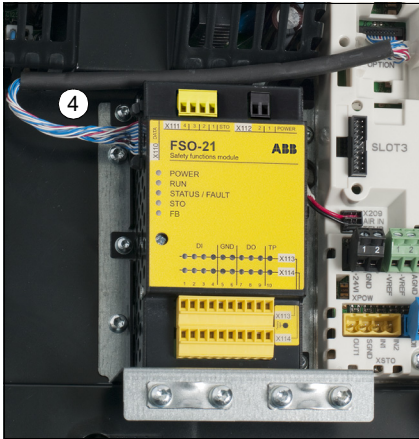

5. Connect the supplied four-wire cable to the FSO terminal X111. Connect the other end of the cable to the drive STO connection (XSTO connector). ABB recommends to use the cable delivered with the FSO module. For a user-defined cable, see section [STO cable and data cable between FSO module and drive](#) on page [519](#).
6. Connect the digital inputs, digital outputs, diagnostic pulses and signal ground at the FSO terminals X113 and X114 according to the application requirements.
 - Use a tightening torque of 0.24 Nm (2.1 lbf-in).
 - Use proper cable strain relief.
 - Use only the I/O terminal blocks attached to the FSO module.
 - Make sure that the ground terminal maximum current is not exceeded. See [Control connection data](#) on page [518](#).

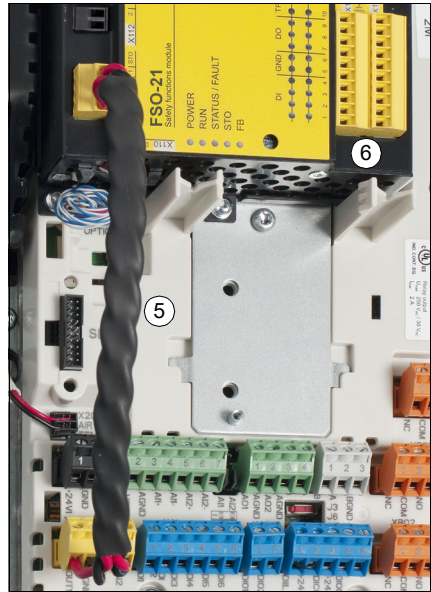
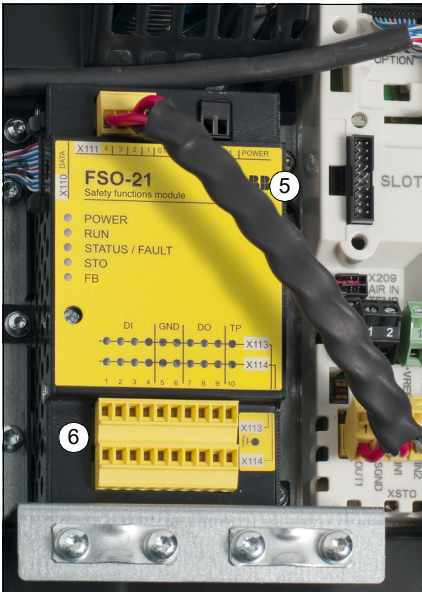

7. Connect the power supply wires to the FSO terminal X112. Use a tightening torque of 0.24 Nm (2.1 lbf·in) for the FSO terminals. Use proper cable strain relief. See also section [Power supply connection/cables](#) on page 291.

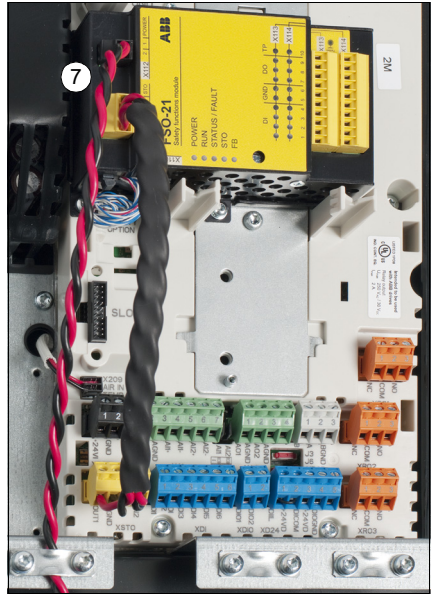
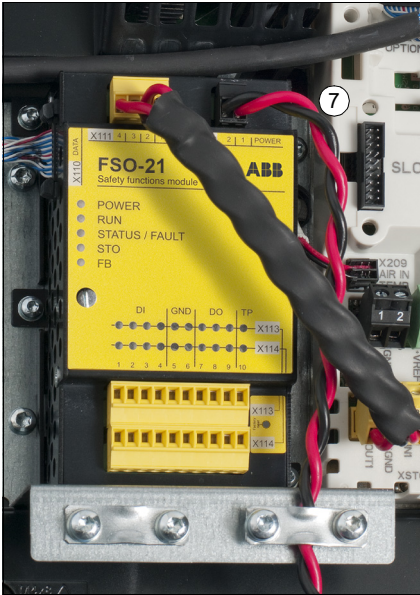



9

Installation checklists

Contents of this chapter

This chapter contains a checklist for checking the mechanical and electrical installation of the FSO module and refers to common cause failure checklists in standards.

Checklists

Check the mechanical and electrical installation of the FSO module before start-up. Go through the checklists below together with another person. Read chapter [Safety instructions](#) before you work on the safety system.



WARNING! Obey the safety instructions. See chapter [Safety instructions](#) on page 13. If you ignore them, injury or death can occur.

Stop the drive and do the steps in section [Electrical safety precautions](#) on page 14 before you start the work.

| Check |
|--|
| <p>MECHANICAL INSTALLATION (See chapter Planning for installation and section Installation: Unpacking.)</p> <ul style="list-style-type: none"> <input type="checkbox"/> The ambient operating conditions are within the allowed range. <input type="checkbox"/> <u>Drives with separate inverter and supply units:</u> Make sure that you have installed the FSO module in the inverter unit. <input type="checkbox"/> The FSO and FSE modules are attached properly and the grounding screw is correctly tightened. <input type="checkbox"/> FSO data cable and STO cable are correctly installed and connected. <input type="checkbox"/> The mechanical connection of the encoder to the motor shaft is secure. The FSE module cannot diagnose mechanical failures outside the encoder, for example, shaft slippage. <input type="checkbox"/> Packing materials and tools have been removed from the installation area. <p>ELECTRICAL INSTALLATION (See chapter Planning for installation and section Installation: Electrical installation.)</p> <ul style="list-style-type: none"> <input type="checkbox"/> If a PELV power supply is used, its ground has to be in the same potential as the drive ground. <input type="checkbox"/> Appropriate supply (input power) fuses are installed. <input type="checkbox"/> Data cable between the drive and the FSO module is routed separately from high power cables (drive supply and motor cabling). <input type="checkbox"/> I/O wiring is appropriately clamped, marked, tightened and protected. |
| <ul style="list-style-type: none"> <input type="checkbox"/> 24 V DC power supply is properly connected and secured with strain relief, and the polarity of the supply voltage connection is correct. |
| <ul style="list-style-type: none"> <input type="checkbox"/> Make sure that the FSO electronics grounding screw is correctly tightened. |
| <ul style="list-style-type: none"> <input type="checkbox"/> Encoder is installed according to instructions given by encoder manufacturer. Encoder signal wires and encoder cable shield to the FSE module are connected according to the FSE module user's manual and they are properly tightened. |



Configuration

Contents of this chapter

This chapter describes the password usage, outlines the configuration process and gives examples of how to configure the FSO module to implement each safety function as described in chapter [Safety functions](#).

Competence

The person who configures the safety functions in the FSO module must be a competent person as required by IEC 61508-1 clause 6. In this context, the person must have adequate expertise and knowledge of functional safety, the safety functions as well as the configuration of the FSO module. ABB has training courses available on the FSO module.

Password

You need a password to be able to upload the parameters from the FSO and download the modified parameters from your PC to the FSO and the drive.

The password is set to “12345678” at the factory. The password must contain 4...8 digits. When you change it, do not forget the new password; otherwise you have to do a factory reset to the FSO which clears the configuration and resets the parameters to the factory defaults. The password is reset to the default “12345678”.

Configuring the FSO module

■ Overview - safety system configuring process

The diagram and table below explain the main phases of the safety system configuring process.

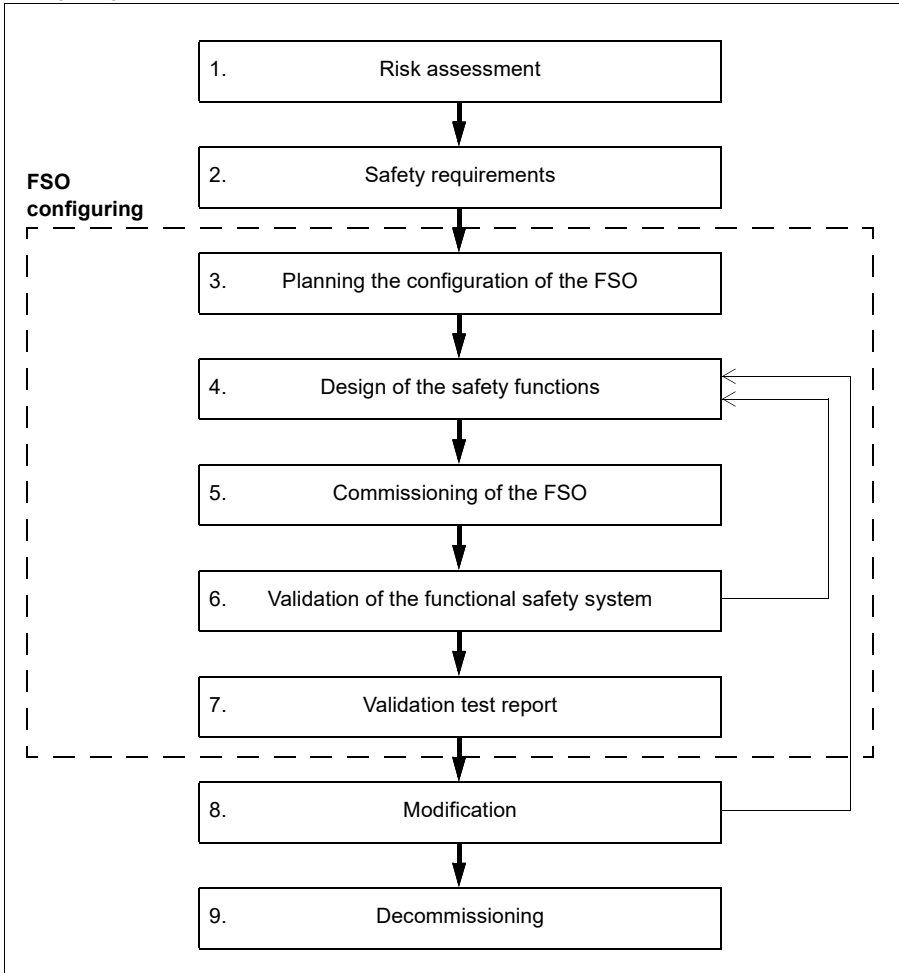

| No. | Phase |
|---------------|---|
| 1.
&
2. | Risk assessment & Safety requirements <ul style="list-style-type: none"> • analysis and evaluating of the risks • need for risk reduction • required PL or SIL level • speed limits and distances for safety functions. |
| 3. | Planning of the configuration of the FSO
How to do the safety configuration in a safe way, including configuration, commissioning, validation and verification. |
| 4. | Design of the safety functions
Selected safety functions and related parameter settings must be based on the risk assessment and the safety requirements of the application. For example: <ul style="list-style-type: none"> • safely limited speed (SLS) trip limits • settings of I/O's • selection of the stopping function • diagnostics and fault reaction, etc. |
| 5. | Commissioning of the FSO <ul style="list-style-type: none"> • configuring and fine tuning of the safety parameters of the FSO module • commissioning of the safety encoder • commissioning of the PROFIsafe connection to the safety PLC • electrical installation, etc. |
| 6. | Validation of the functional safety system
Validation of the safety functions which are used in the safety system: They operate as required in the application, and the safety requirements (SRS) arising from the risk assessment are fulfilled.

If any of the safety functions does not pass the validation tests, it is necessary to return to the design phase, and modify the safety function so that it fulfills the safety requirements from the risk assessment. After the modification, the validation test(s) must be repeated and passed.
See chapter Verification and validation . |
| 7. | Validation test report
Validation must be properly documented and stored.
See section Validation test reports on page 461 . |
| 8. | Modification
After the modifications, the validation tests must be repeated and passed. |
| 9. | Decommissioning |

■ FSO configuring procedure

The FSO parameters are set with the Drive Composer pro PC tool. The names of the FSO parameters and parameter settings are shown in the manual as they appear on the screen when using the tool. See *Drive Composer PC tool user's manual* (3AUA0000094606 [English]) for instructions on using the tool.

You must always check all parameter values to make sure that they are suitable for your application. The pre-set values in a delivered FSO module or factory default values are not valid for any safety application as such.

Note: Configuration is only possible when the drive is not modulating or the FSO is in the Safe state.

Note: FSO-12 and FSO-21 have different firmware versions, and thus their safety configuration files are not compatible.

Note: After you initially start up the FSO and also after you later modify any application parameters or the configuration, you must check the safety of the entire system by doing a verification according to the system safety verification plan and by doing a validation of the correct operation of the safety application. See chapter [Verification and validation](#).

1. Plan the configuration (parameter values) according to the safety requirements of the system, installation, wiring, etc. These requirements should be based on the risk assessment of the application. The configuration should take into account also the electrical design documents of the system.
2. Set the parameter values for the FSO module using the Drive Composer pro PC tool.
 - a. Power up the drive and make sure that the motor is not running.
 - b. Connect your PC to the drive, start the Drive Composer pro PC tool and select **Safety settings**.
 - c. Open the parameters for setting:
 - First configuration: Upload the parameters from the FSO to the PC tool (button **Read settings from drive**). A password is required. Make a backup copy of the pre-set safety file (button **Save to file**).
 - Existing configuration: Open the configuration file (button **Load from file**).

Note: When you upload parameters from the FSO module to the PC tool, the FSO goes into the Configuration mode and indicates a fault ([7A8B](#)). You can exit the Configuration mode by rebooting the FSO module (for rebooting instructions, see [FSO recovery](#) on page [506](#)) or by downloading the parameters to the FSO (steps 2.e - f below).

- d. Set the parameter values.
 - Encoder interface (if used): Configure the encoder parameters before you configure any safety functions.
 - General parameters: Check at least that the motor parameters are correct
 - Safety fieldbus communication (if used): Set up the communication between the safety PLC and FSO module.
 - Safety functions: You must at least check and set the parameters related to the STO and SSE functions, regardless of what you use the FSO for or which safety functions you use. The FSO can activate the STO and SSE functions in internal fault situations. The STO and SSE functions are essential for the FSO to be able to make the system safe.
 - I/O: Check that the I/O parameters are set according to the installation (wiring) plan. Set diagnostic pulsing for I/Os when necessary. Check possible safety relays and cascade connections.

Note: Make sure that the diagnostic pulsing settings are compatible with all devices in the system (for example, switches, light curtains and PLCs).
 - e. After configuring all necessary functions, do these two steps:
 - Download the configuration to the FSO (button **Download to FSO and validate**). A password is required.
 - Save the configuration to your PC (button **Save safety file**).
 - f. After downloading, the FSO and the tool validate the configuration, and the tool asks you to confirm the validation.
 - g. Change the password to protect the settings (button **Change password**). A password is required.

Note: The motor must be stopped when you change the password.
3. Validate safety functions, print the report from the configuration, including all the values of the parameters and CRC. Sign and store the report according to your safety management plan. **Note:** You can use the safety configuration report in the Drive Composer pro PC tool for this purpose.

Note: Make sure you saved the safety file after validation for later use. The safety file is not included in the drive backup process.

Note: If you want to clear the configuration and start again from the factory setup, do a factory reset. See section [Factory reset](#) on page 513.

Configuring general settings

■ How to configure general settings

To configure the general settings, set the FSO parameters listed below to appropriate values using the Drive Composer pro PC tool. See parameter group [FSOGEN](#) on page [180](#).

Example: The figure below shows an example I/O set-up:

- After power-up, the acknowledgement can only be performed manually ([FSOGEN.41 Power-up acknowledgement = Manual](#)).
- Acknowledgement button is connected to input X114:4 ([FSOGEN.42 Acknowledgement button input = DI X114:4](#)).
- [FSOGEN.22 Motor nominal frequency = 50.00 Hz](#). Use the same value with the drive parameter [99.08. Motor nominal frequency](#), and the value on the motor type designation label. **Note:** For a DCS880 drive, set this value to *25 Hz*.
- [FSOGEN.21 Motor nominal speed = 1500.0 rpm](#). Set this parameter to the motor synchronous speed, not the nominal speed. The nominal speed is shown on the motor type designation label. **Note:** For a DCS880 drive, the equivalent parameter is [99.14 M1 nominal \(base\) speed](#).
- [FSOGEN.51 Zero speed without encoder = 90.0 rpm](#) (when an encoder is used: [FSOGEN.52 Zero speed with encoder](#)). Stopping functions are considered to be completed at this speed. Use suitable (low enough) value according to application.
- External requests ending in the drive STO are reported to the drive as events ([FSOGEN.61 STO indication ext request = Event](#)).
- Safety function limit hits are reported as faults ([FSOGEN.62 STO indication safety limit = Fault](#)).
- No output connected for the completion of stop functions (STO, SSE, SS1) ([FSOGEN.11 Stop completed output = None](#)).

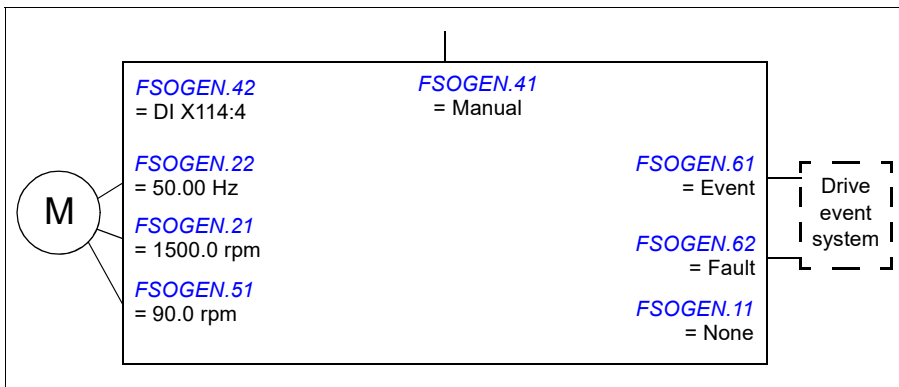

Configuring the safety encoder interface

■ How to configure the safety encoder interface

To configure the safety encoder interface, set the drive and FSO parameters listed below to appropriate values using the Drive Composer pro PC tool. See parameter groups [Safety](#), [S_ENCGEN](#), [Enc module settings](#) (91) and [Encoder 1 configuration](#) (92) on pages 404 - 443 and the drive firmware manual.

Example: The pulse encoder interface module type is FSE-31 and it is installed in Slot 2 on the drive control board. One HTL encoder is used.

Set these drive parameters in the **Parameters** view of the Drive Composer pro PC tool:

- The motor speed feedback during motor control is from Encoder 1:
ACS880: 90.41 Motor feedback selection = Encoder 1
DCS880: 90.41 M1 feedback selection = Encoder 1
- The drive generates a warning if an encoder failure occurs:
ACS880: 90.45 Motor feedback fault = Warning
DCS880: 31.35 Motor feedback fault = EMF/Warning.

Make sure that the following parameter has the correct default values:

- Encoder cable channels A, B and Z are monitored for wiring faults:
92.21 Encoder cable fault mode = A+, A-, B+, B-, Z+, Z-.
-

Set these FSO parameters in the **Safety settings** view of the Drive Composer pro PC tool:

- Communication with the FSE module activated:
200.231 FSE 3X act and par version = Version 1
 - One safety encoder is connected to the FSE module:
200.232 Number of encoders = Single encoder CH1.
 - Safety encoder activated:
S_ENCGEN. 01 Safe pulse encoder version = Version 1
 - The FSO module activates the drive STO function if there is a fault in the FSE module or with the safety encoder: *S_ENCGEN.11 FSE diagnostic failure reaction = STO*
 - Cross comparison tolerance: 5 rpm (sets how much the shaft speed of the motor can change within 1 ms)
S_ENCGEN.14 Enc speed cross comp tolerance = 5 rpm
 - Rotation direction not changed:
S_ENCGEN. 41 Gear numerator encoder 1 = 1
 - *91.11 Module 1 type = FSE-31*
 - *91.12 Module 1 location = 2*
 - *92.01 Encoder 1 type = HTL1*
 - *92.02 Encoder 1 source = Module 1*
 - Number of HTL pulses per rotation: *92.10 Pulses/revolution = 1024 ppr.*
Note: Make sure that the value is according to the encoder nameplate.
-

- The maximum pulse frequency range of Encoder 1:

[92.17 Accepted pulse freq of encoder 1](#) = 220 kHz.

Note: You can use this formula to define the value:

$r_max \times ppr_enc + 10\%$, where

- r_max = the maximum motor speed (rpm) used in the application (or the motor nominal speed)
- ppr_enc = Pulses/revolution of the safety pulse encoder (parameter [92.10](#)).

Set the parameter value in kHz.

Example: When $r_max = 1000$ rpm and $ppr_enc = 1024$,

[92.17 Accepted pulse freq of encoder 1](#) becomes 19 kHz:

- $1.1 \times (1024 \times 1000 \text{ rpm} / 60) = 18.773$ (19).

Download the parameters to the FSO module and validate the safety encoder configuration before you configure any safety functions.

■ Diagnostics of FSE-31 encoder interface module

The diagnostics of the FSE module detect encoder failures by monitoring the validity of the encoder signals (A/_A, B/_B, Z/_Z) and the pulse count. The monitoring is based on parameters [S_ENCGEN.14](#), [92.10](#) and [92.17](#):

- [S_ENCGEN.14](#) defines how big the difference between the speed information in the internal channels 1 and 2 from FSE to FSO module can be. If the difference is bigger, FSO module goes into the fail state and stops the system safely (STO).

The speed information is read from the FSE to FSO module through two channels of 1oo2 structure. The channels may be out of sync by 1 ms. This delay causes some speed difference between the channels during the motor acceleration or deceleration.

Suitable value for the speed difference depends on the configuration (motor and load). Typically it is 2-10 rpm. Too small value will cause unnecessary encoder faults ([A7D8](#)), and too big value will prevent the detection of a problem.

- [92.10 Pulses/revolution](#) sets the pulse count of the safety encoder
- [92.17 Accepted pulse freq of encoder 1](#) sets the limit for the maximum accepted frequency from the single signal of the safety encoder to the FSE module.

FSE module detects the following failures with the internal diagnostics functions:

- temperature fault
 - max. pulse frequency exceeded fault
 - internal voltage fault
 - parameter difference fault
 - encoder or encoder cable fault.
-

■ Disabling the safety encoder interface

You must do the steps below to disable the FSE module in the FSO module configuration. The drive is still using the measured motor speed data for the motor control purposes if drive parameter *90.41 Motor feedback selection = Encoder 1* (in an ACS880 drive) / *90.41 M1 feedback selection = Encoder 1* (in a DCS880 drive).

FSE module disabling steps:

1. Set *S_ENCGEN. 01* = Disable
 2. Set *91.11* = None
 3. Set *200.232* = None
 4. Set *200.231* = Disabled
 5. Download the safety file to FSO module.
 6. Make sure that the encoder-related parameters in drive parameter groups 91-92 are not locked any more. This indicates that FSO is not using the encoder.
 7. Make sure that drive parameter *90.41* is set to *Encoder 1* if motor control must still use encoder data. If also drive must use speed estimate, *90.41* must be set to *Estimate*. **Note:** Safe speed estimate cannot be used with a DCS880 drive.
-

Configuring the FSO for FSE or encoder failure situations

Always set this parameter to a suitable value:

- [STO.14 Time to zero speed with STO and modoff](#)

If the SBC function is in use, set also these parameters:

- [SBC.13 SBC time to zero speed](#)
- [SBC.12 STO SBC delay*](#).

* Even if you use the speed limit activated SBC function ([SBC.11 = Speed limit](#)), the FSO module starts to use the time controlled brake ([SBC.11 = Delayed brake](#)) when it detects an FSE module or encoder fault. Then also the time defined by [SBC.12](#) is in effect.

Encoder diagnostics failure reaction

You can configure how the FSO module reacts when motor speed data from FSE module is lost due to e.g. failure in FSE module, safety encoder or its wiring. The reaction is user-definable with parameter [S_ENCGEN.11 FSE diagnostic failure reaction](#) and depends also on the status of safety functions.

Use parameter [S_ENCGEN.11](#) to define the correct FSO reaction. There are three alternatives: 1. *STO*, 2. *no STO* or 3. *Est switch not active load*. See the subsections below.

Alternative 1: [S_ENCGEN.11 = STO](#)

The FSO module goes into the Fail-safe state and activates the FSO STO function immediately when the encoder data is lost regardless of the status of the safety functions.

For more information, see section [FSO modes](#) on page 60.

Alternative 2: [S_ENCGEN.11 = No STO](#)

FSO module does not react to encoder fault unless there are active safety functions or some safety function is activated, while the encoder fault occurs. Thus, the selection gives the user the possibility to fix the cause of the encoder data-related failure before a safety function is activated.

If some safety function is active or activated when the encoder fault occurs, the FSO module goes into the Fail-safe state. The SSM and POUS functions are exceptions: They do not cause the Fail-safe state transition when an encoder fault occurs.

Also drive parameter [90.45 Motor feedback fault](#) must be set to *Warning* to be able to use this setting. **Note:** For a DCS880 drive, the equivalent parameter/setting is [31.35 Motor feedback fault = EMF/Warning](#).

Alternative 3: [S_ENCGEN.11 = Est switch not active load](#)

Note: This alternative is not applicable to a DCS880 drive.

With this selection, the application can continue the operation and the FSO module keeps the monitoring safety functions (SLS, SMS, SSM) active even if the encoder data is lost. FSO module sends a warning to the drive about missing encoder data. FSO module switches to use the estimated motor speed instead of the measured motor speed from the encoder until the failure is fixed. However, if the encoder data is lost while the stopping functions (STO, SSE or SS1) are on-going (zero speed limit has not been reached) or SDI function is requested while encoder data is still missing, the FSO module goes to Fail-safe state.

Note that also drive parameter *90.45 Motor feedback fault* must be set to *Warning* to be able to use this setting.



WARNING! You can use this feature only if the use of the safe speed estimate data for safety function purposes is allowed from the application and risk assessment point of view.



WARNING! Do not use this feature in applications in which the external load of the application can rotate the motor shaft (active load). In this case, you must always use an encoder.

If it is allowed, from the risk assessment point of view, to use the feature to switch the motor speed feedback between encoder and safe speed estimate, you must configure and validate the FSO module and all safety functions so that they operate correctly both with and without an encoder.

Note: SDI function can never be used with the safe speed estimate data.

Note: This feature requires ACS880 primary control program version 2.51 or later.

Make sure that you configure all safety functions so that they operate correctly both with and without an encoder. Note especially these parameters and restrictions:

- You must set two zero speed limits: [FSOGEN.51 Zero speed without encoder](#) and [FSOGEN.52 Zero speed with encoder](#).
- The SLS trip limits cannot be below these zero speed limits.
- The “mute times” are different with and without an encoder (see section [Configuring mute times](#) on page 395).
- You cannot use this feature with the SDI function.

Configuring the safety fieldbus communication

■ How to configure the safety communication with PROFIsafe

To configure the safety fieldbus communication between the FSO module and a safety PLC, set the FSO parameters shown in the figure below to appropriate values using the Drive Composer pro PC tool. See parameter groups [Safety](#) on page 404, [SBUSGEN](#) on page 449 and [PROFIsafe](#) on page 449.

In addition, you must install the FB module to the drive and set up the safety communication network between the modules as described in chapter [PROFIsafe](#).

Example:

- PROFIsafe communication activated
([SBUSGEN. 01 SBUS activity and version](#) = Version 1 and [200.222 Safety bus type](#) = PROFIsafe)
- Speed scaling: 1500 rpm
([SBUSGEN. 06 Safety fieldbus speed scaling](#) = 1500 rpm)
- When an encoder is used: Position scaling: 1000
([SBUSGEN. 07 Safety fieldbus position scaling](#) = 1000)
- the FSO module generates a fault message if the module is passivated due to safety fieldbus problems
([SBUSGEN.10 STO indication passivation](#) = Fault)
- the FB module is connected to option slot 1
([200.223 Safety fieldbus adapter slot](#) = FBA A and [50.01 FBA A enable](#) = 1)
- PROFIsafe profile ABB_PS1 in use
([PROFIsafe. 12 PROFIsafe telegram type](#) = 0x221)
- IP address of the FB module: 1
([PROFIsafe.11 PROFIsafe F_Dest_Add](#) = 1)

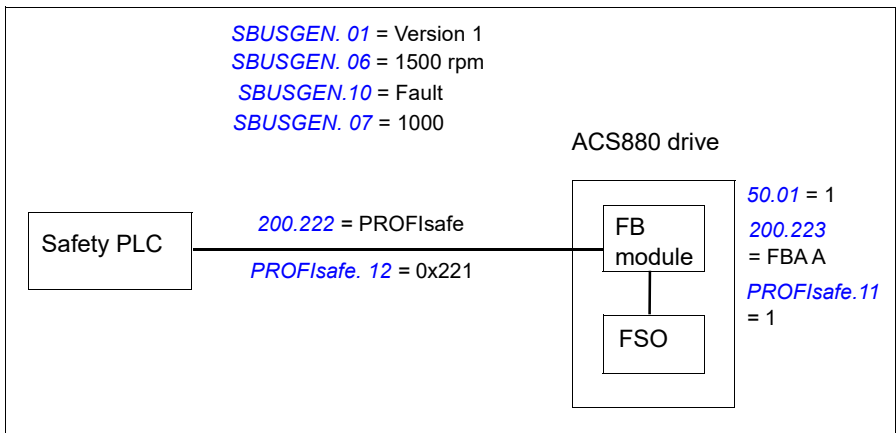

Configuring I/O

■ How to configure I/O

To configure the I/O, set the FSO parameters shown in the figure below to appropriate values using the Drive Composer pro PC tool. See parameter group [SAFEIO](#) on page [443](#).

The location of the input and output terminals on the FSO module is shown in section [Layout](#) on page 38.

Inputs

Inputs can be configured into use with different safety functions. It is possible to select either single or redundant inputs in use. For example, if a single input X113:1 is supposed to activate the STO function, user must configure this input in use in the STO configuration view.

There are input A and input B for the safety functions. User can use them either for cascading, or for connecting two different and independent activation switches for the same function.

It is possible to set diagnostic pulses for the inputs. User must set the pulse length and period, and also define the inputs which use the pulses.

Outputs

Outputs can be configured into use for different safety functions ([Safety function indications](#) on page 58), a safety relay, the SBC function, and a cascade loop. User can select the output type (single or redundant output), and set the logic state for each digital output. The logic state of output can be configured to be active low or active high.

For some of the safety functions, output A and output B are available. This enables the use of cascaded functions, and the function specific indications.

It is possible to set diagnostic pulses for the outputs. User must set the pulse length and period, and also define the outputs which use the pulses.

Note: Make sure that the I/O configuration for safety functions is set up according to the circuit diagrams.

Safety relay output

The safety relay output is used to the control of the safety relay. This output is redundant and has a feedback input.

I/O redundancy

Redundant input or output is configured by selecting I/O pair to safety function I/O parameter. For example, redundant input for STO function: DI X113:1 & X114:1 must be configured either to STO input A or input B.

Example: The figure below shows an example I/O set-up:

- All inputs use diagnostic pulses with 1 ms width and 30 s period.
- One redundant cascaded connection from input 1 to output 7
- One safety relay (always redundant) connected to output 8 with feedback connected to input 3
- All outputs, except X114:9, have active low logic state and diagnostic pulsing on. Pulse width 1 ms and period 59 s.
- Output X114:9 has active high logic state and diagnostics pulses are not used.

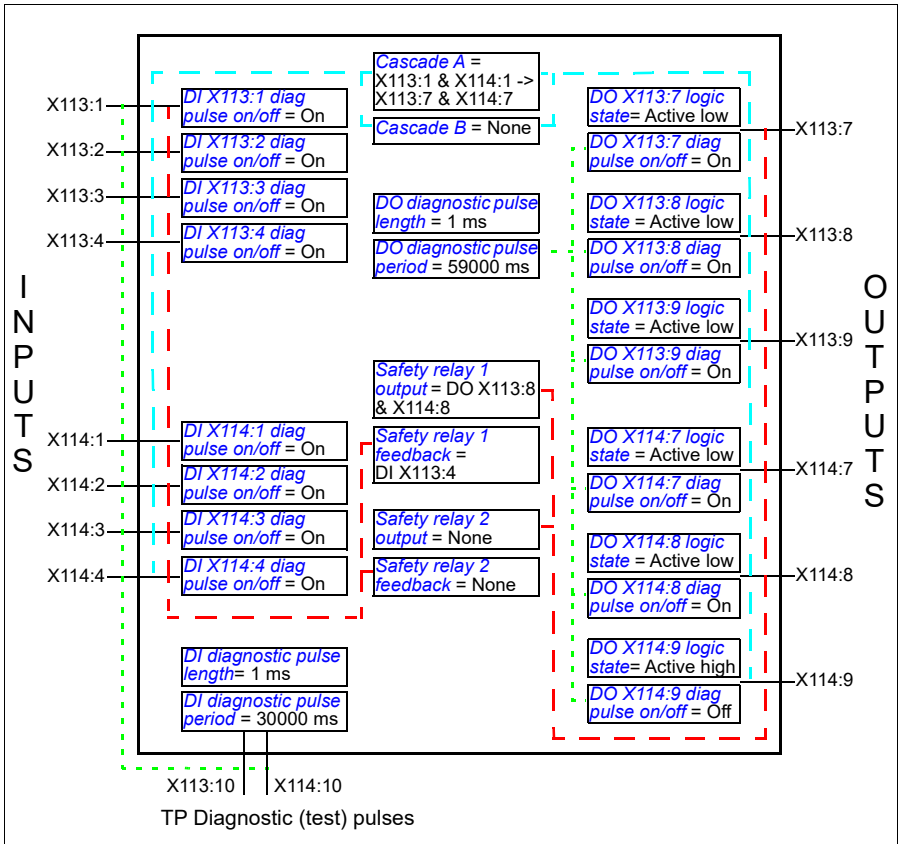

Note: The safety relay inputs and outputs must be configured so that in the Safe state the circuit is disconnected (0 V).

■ How to configure a cascaded system

This example shows how to configure the cascaded system (Cascade A) as shown in section [Cascade](#) on page 63. The SSE function is used as an example (*Safety function 1* in the figure on page 63). In this configuration example, Cascade B is not configured (parameter [SAFEIO.13 Cascade B](#) = None).

1. Define one of the FSO modules as the master and the other FSO modules are followers in Cascade A:
 - In the master FSO: [SAFEIO.11 M/F mode for cascade](#) =
A = master, B = master (only Cascade A is configured in this example).
 - In the follower FSOs: [SAFEIO.11 M/F mode for cascade](#) =
A = follower, B = follower (only Cascade A is configured in this example).
 2. Connect a digital input to the corresponding digital output in the cascaded system (single cascade X113:2 -> X113:8):
 - [SAFEIO.12 Cascade A](#) = X113:2 -> X113:8.
 3. Set the digital inputs and outputs of the SSE function as defined for the cascaded system:
 - The SSE function is activated from a redundant digital input in the master FSO ([SSE.11 SSE input A](#) = DI X113:1&X114:1)
 - The SSE function is cascaded back to the master FSO with a single digital input and output ([SSE.12 SSE input B](#) = DI X113:2, [SSE.21 SSE output](#) = DO X113:8)
 - The SSE function is cascaded with a single digital input and output in the follower FSOs ([SSE.12 SSE input B](#) = DI X113:2, [SSE.21 SSE output](#) = DO X113:8).

Note: Do not use the completed output of the safety function as the cascaded output (parameter ([SSE.22 SSE completed output](#) = None, or you can use this output for the safety function indication).
 4. Set the acknowledgement method in the master FSO modules (in this example, *Manual* is used):
 - [STO.02 STO acknowledgement](#) = Manual
 5. Set the digital input for the acknowledgement button in the master FSO module:
 - [FSOGEN.42 Acknowledgement button input](#) = DI X114:2.
 6. Set the acknowledgement method in the follower FSO modules (must be *Automatic* in the follower FSOs).
 - [STO.02 STO acknowledgement](#) = Automatic
 7. Set the other parameters related to the SSE function as defined in section [Configuring SSE](#) on page 353.
-

Parameter settings in the master FSO

| Index | Name/Value | Description |
|---------------------------|--------------------------------------|--|
| SAFEIO.11 | M/F mode for cascade | Sets the master/follower mode of the FSO module for both cascade connections A and B separately. In this example, only cascade connection A is used. |
| | A = master,
B = master | This module is the master on cascade connection A. |
| SAFEIO.12 | Cascade A | Sets the cascade connection A for the FSO module. For each FSO module in cascade A, the digital input connected to the safety function is also internally connected to the corresponding digital output of the module (digital input -> digital output). |
| | X113:2 ->
X113:8 | Single cascade X113:2 -> X113:8 |
| SAFEIO.13 | Cascade B | Sets the cascade connection B for the FSO module. |
| | None | Not cascaded |
| STO.02 | STO acknowledgement | Sets the acknowledgement method used in the STO, SSE and SS1 functions.

See section Acknowledgement methods on page 55 for more information on different acknowledgement methods. |
| | Manual | The FSO module reads the external STO acknowledgement signal through the digital input defined by parameter FSOGEN.42 Acknowledgement button input . |
| SSE.11 | SSE input A | Sets the digital input that is connected to the primary input of the SSE function.

In this example, this parameter sets the digital input that is used for the activation of the SSE function in the master FSO. |
| | DI X113:1 &
X114:1 | Redundant input X113:1 & X114:1 |
| SSE.12 | SSE input B | Sets the digital input that is connected to the secondary input of the SSE function.

In this example, this parameter sets the digital input that is used in the cascade loop (Cascade A) to cascade the SSE function back to the master FSO. |
| | DI113:2 | Single input X113:2 |
| SSE.21 | SSE output | Sets the digital output that indicates the activity of the SSE function. Active from the SSE request until the function has been acknowledged.

In this example, this parameter sets the digital output that is used in the cascade loop (Cascade A) to cascade the SSE function to the follower FSOs. |
| | DO X113:8 | Single output X113:8 |
| SSE.22 | SSE completed output | Sets the digital output that indicates the completion of the SSE function.

In this example, output X113:7 is connected to the indication lamp. |
| | DO X113:7 | Single output X113:7 |

| Index | Name/Value | Description |
|------------------|------------------------------------|--|
| <i>FSOGEN.42</i> | <i>Acknowledgment button input</i> | Sets the digital input that is connected to the button for acknowledgement operations. |
| | DI X114:2 | Single input X114:2 |

Parameter settings in the follower FSOs

| Index | Name/Value | Description |
|---------------------------|--------------------------------------|--|
| SAFEIO.11 | M/F mode for cascade | Sets the master/follower mode of the FSO module for both cascade connection A and B separately. In this example, only cascade connection A is used. |
| | A = follower,
B = follower | This module is a follower on cascade connection A. |
| SAFEIO.12 | Cascade A | Sets the cascade connection A for the FSO module. For each FSO module in cascade A, the digital input connected to the safety function is also internally connected to the corresponding digital output of the module (digital input -> digital output). |
| | X113:2 ->
X113:8 | Single cascade X113:2 -> X113:8 |
| STO.02 | STO acknowledgement | Sets the acknowledgement method used in the STO, SSE and SS1 functions. |
| | Automatic | The FSO module generates the STO acknowledgement signal automatically after the STO, SSE or SS1 request has been removed and the stop function is completed (output defined by parameter FSOGEN.11 Stop completed output is active). |
| SSE.11 | SSE input A | Sets the digital input that is connected to the primary input of the SSE function.

In this example, the activation of the SSE function in the follower FSOs comes from the master FSO through the cascade loop (Cascade A), and this parameter must be set to <i>None</i> . |
| | None | No input connected |
| SSE.12 | SSE input B | Sets the digital input that is connected to the secondary input of the SSE function.

In this example, this parameter sets the digital input that is used in the cascade loop (Cascade A) to cascade the SSE function to the follower FSOs. |
| | DI X113:2 | Single input X113:2 |
| SSE.21 | SSE output | Sets the digital output that indicates the activity of the SSE function. Active from the SSE request until the function has been acknowledged.

In this example, this parameter sets the digital output that is used in the cascade loop (Cascade A) to cascade the SSE function to the follower FSOs. |
| | DO X113:8 | Single output X113:8 |
| SSE.22 | SSE completed output | Sets the digital output that indicates the completion of the SSE function. |
| | None | No output connected |

■ How to configure safety relays

If you want to control a safety relay or contactor with the FSO module, define the use of the related I/O with these parameters. See also section [Relay / contactor output with feedback](#) on page 293.

| Index | Name/Value | Description |
|---------------------------|--|--|
| SAFEIO.21 | Safety relay 1 output | Sets the digital output connected to the safety relay 1. |
| | DO X113:8 & X114:8 | Redundant output X113:8 & X114:8 |
| SAFEIO.22 | Safety relay 1 feedback | Sets the digital feedback input of safety relay 1. |
| | DI X113:4 | Single input X113:4 |
| SAFEIO.23 | Safety relay 1 feedback type | Sets the type of the feedback signal for safety relay 1. |
| | Mechanically linked NC contacts | Feedback of the safety relay is NC (inverted state compared with the relay). |
| SAFEIO.24 | Safety relay 2 output | Sets the digital output for safety relay 2. |
| | None | No output connected |
| SAFEIO.25 | Safety relay 2 feedback | Sets the digital feedback input of safety relay 2. |
| | None | No input connected |
| SAFEIO.26 | Safety relay 2 feedback type | Sets the type of the feedback signal for safety relay 2. |
| | Mechanically linked NC contacts | Feedback of the safety relay is NC (inverted state compared with the relay). |

Do not configure a safety function activation to a safety relay feedback. In addition, you have to connect the safety relay to the desired safety function. Set the same digital output as you set for the safety relay as the output of the desired safety function. In this example, safety relay 1 is connected to the SBC function.

| Index | Name/Value | Description |
|------------------------|----------------------------|---|
| SBC.21 | SBC output | Sets the digital output that is connected to the SBC output (brake relays). |
| | DO X113:8 & X114:8 | Redundant output X113:8 & X114:8 |

Configuring SBC

When you use the SBC function (brake) with other safety functions of the FSO module, it is always combined with the drive STO function. That is, the SBC function is activated before, at the same time with or after the drive STO function.

You can configure the SBC in the STO, SSE and SS1 functions:

- If you configure the SBC in the STO function, this also takes it into use in the SSE with immediate STO function.
- If you configure the SBC in the SS1 function, this also takes it into use in the SSE with emergency ramp function.



WARNING! If SBC function is in use, automatic acknowledgement will automatically release the safe brake immediately when the STO request is removed. Prevent unexpected start-up in the case of using SBC together with automatic acknowledgement.

SBC at zero speed limits

When you configure the SBC function in the STO function, the SBC is activated also when the drive STO is activated at the zero speed in the SSE and SS1 functions. Depending on how the SBC is configured, the SBC is activated before or at the same time with the drive STO function. See section [Safe torque off \(STO\)](#) on page 68.

SBC at trip limit hits

The FSO module activates the SSE function after trip limit hits in the SLS, SMS and SDI functions. You can configure the SSE function either with immediate STO (stop category 0) or with emergency ramp (stop category 1), see section [Safe stop emergency \(SSE\)](#) on page 107. If you want that the SBC is activated at trip limit hits, you have to configure the SBC function in the correct SSE function.

Note: Make sure that you dimension the brake correctly for these situations.

SBC at monitoring limit hits

The FSO module activates the STO function after time or ramp monitoring limit hits in the SS1, SSE with emergency ramp, SLS and SDI functions. If you want that the SBC is activated at monitoring limit hits, you have to configure the SBC function in the STO function.

Brake failure situations

To make sure that the system is set to safe state also if the brake fails to operate, set parameter [STO.14](#) to a suitable value. If the safety function is not completed before this time has elapsed, the system is set to the safe state.

Define also the FSO module reaction to a missing brake feedback signal (parameter [SBC.22 SBC feedback action](#)).

FSO internal fault situations

The FSO module activates STO and SBC if configured into use in internal fault situations.

■ How to configure the SBC in the STO function

Use these parameters to configure the SBC:

1. Set the how the brake is used with parameter [SBC.11 STO SBC usage](#):
 - *None*: the SBC is not used
 - *Delayed brake* (the value can be positive, zero or negative)
 - *Speed limit* (possible only when an encoder is used).
2. Set the correct delay with parameter [SBC.12 STO SBC delay](#):
 - If the value is zero (*0 ms*), the FSO activates the SBC and drive STO functions at the same time.
 - If the value is positive, the FSO activates the SBC after the drive STO. See section [How to configure SBC after STO](#) on page 335.
 - If the value is negative, the FSO activates the SBC before the drive STO. See section [How to configure SBC before STO](#) on page 337.
3. If you use the speed limit activated SBC function, set the correct SBC speed limit with parameter [SBC.14 STO SBC speed](#).
 - The drive STO function is activated when the STO request is received and the SBC when the SBC speed limit is reached. See section [How to configure STO with speed limit activated SBC](#) on page 339).

See also section [How to configure mute time for SBC speed limit detection](#) on page 400.

■ How to configure the SBC in the SS1 function

Use these parameters to configure the SBC:

1. Set the correct SBC speed limit with parameter [SBC.15 SSE/SS1 SBC speed](#):
 - If the value is zero (*0 rpm*) the SBC is not used in the SS1 and SSE with emergency ramp functions.
 - If the value is positive (the corresponding negative value is used in the opposite direction), the FSO activates the SBC and drive STO functions at the same time when the speed limit is reached. See section [How to configure SS1 with speed limit activated SBC](#) on page 345.
2. You can also set a negative delay with parameter [SBC.12 STO SBC delay](#):
 - If the value is negative, the FSO activates the SBC at the speed limit (set with parameter [SBC.15 SSE/SS1 SBC speed](#)) and the drive STO after this delay. See section [How to configure SS1 with speed limit activated SBC, SBC before STO](#) on page 349.
 - If the value is zero (*0 ms*) or positive, the FSO activates the SBC and drive STO functions at the same time when the speed limit is reached.

Note: If parameter [SBC.11 STO SBC usage](#) is *Delayed brake*, the same parameter [SBC.12 STO SBC delay](#) is used also in the STO and SSE with immediate STO functions (see section [How to configure the SBC in the STO function](#) on page 331). In the SS1 (and SSE with emergency ramp) function, this parameter is relevant always when parameter [SBC.15 SSE/SS1 SBC speed](#) is not zero.

Monitoring limit hits in the SS1 function

When you configure the SBC in the SS1 (and SSE with emergency ramp) function, this does not take the SBC into use in the STO function. Therefore, the SBC is not activated in limit hit situations if parameter [SBC.11 STO SBC usage](#) is *None*. For limit hit situations, you have to configure the SBC also in the STO function. See section [How to configure the SBC in the STO function](#) on page 331.

See also section [How to configure mute time for SBC speed limit detection](#) on page 400.

Configuring STO

To configure the STO function, set the FSO parameters listed below to appropriate values using the Drive Composer pro PC tool. See parameter groups [STO](#) on page [411](#) and [SBC](#) on page [414](#).

For more information on the STO and SBC functions, see page [69](#).

Note: Always set the parameters related to the STO function to have the correct monitoring limit hit and fault reaction behavior.

Note: If an encoder failure occurs, the FSO module activates the STO function. For these situations, you have to configure the STO function also without an encoder (set parameter [STO.14 Time to zero speed with STO and modoff](#) or [SBC.13 SBC time to zero speed](#) to a suitable value according to your application).

■ How to configure STO

Example 1 (without an encoder): The figure below shows an example of a simple STO function set-up when an encoder is not used:

- redundant emergency stop button connected to input ([STO.11 STO input A](#) = DI X113:1 & X114:1)
- automatic acknowledgement ([STO.02 STO acknowledgement](#) = Automatic)
- estimated time in which the motor coasts to a stop from the maximum speed is 1500 ms ([STO.14 Time to zero speed with STO and modoff](#) = 1500 ms)
- the fly-start feature is in use, that is, you can restart the drive before the motor has stopped ([STO.13 Restart delay after STO](#) = 1000 ms)
- no output connected
- no brake ([SBC.11 STO SBC usage](#) = None).

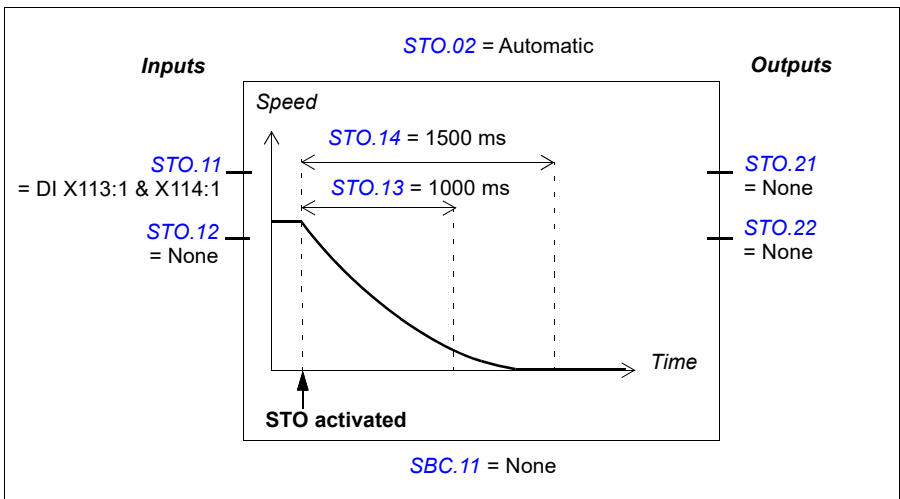

Example 2 (with an encoder): The figure below shows an example of a simple STO function set-up when an encoder is used. Configure the safety encoder interface first (see section [Configuring the safety encoder interface](#) on page 315).

- redundant emergency stop button connected to input (*STO.11 STO input A* = DI X113:1 & X114:1)
- automatic acknowledgement (*STO.02 STO acknowledgement* = Automatic)
- zero speed limit where STO function is completed and it can be acknowledged is 40 rpm (parameter *FSOGEN.52 Zero speed with encoder* = 40 rpm)
- the fly-start feature is in use, that is, you can restart the drive before the motor has stopped (*STO.13 Restart delay after STO* = 1000 ms)
- no output connected
- no brake (*SBC.11 STO SBC usage* = None).

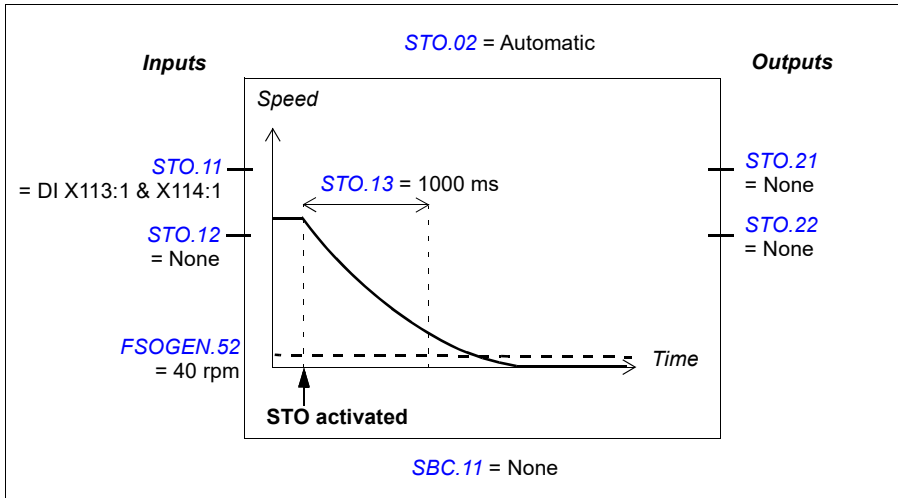

How to configure SBC after STO

For more information on the SBC after STO function, see page 72.

Example 1 (without an encoder): The figure below shows an example of the SBC after the STO function set-up when an encoder is not used:

- STO delayed brake with positive delay 900 ms
(*SBC.11 STO SBC usage* = Delayed brake, *SBC.12 STO SBC delay* = 900 ms)
- redundant emergency stop button connected to input
(*STO.11 STO input A* = DI X113:1 & X114:1)
- automatic acknowledgement (*STO.02 STO acknowledgement* = Automatic)
- estimated time in which the motor brakes to a stop from the maximum speed: 400 ms (*SBC.13 SBC time to zero speed* = 400 ms)
- the fly-start feature is not in use, that is, you cannot start the motor before it has stopped (*STO.13 Restart delay after STO* = 1300 ms)
- brake connected to redundant output, diagnostic pulses activated
(*SBC.21 SBC output* = DO X113:7 & X114:7, *SAFEIO.53* and *SAFEIO.56* = On),
SAFEIO.21 Safety relay 1 output = DO X113:7 & X114:7)
- STO is activated if brake feedback fails (*SBC.22 SBC feedback action* = STO)
- feedback from the brake is connected to digital input X113:2
(*SAFEIO.22 Safety relay 1 feedback* = DI X113:2)
- feedback input type NC (inverted state compared with the brake relay)
(*Safety relay 1 feedback type* = Mechanically linked NC contacts).

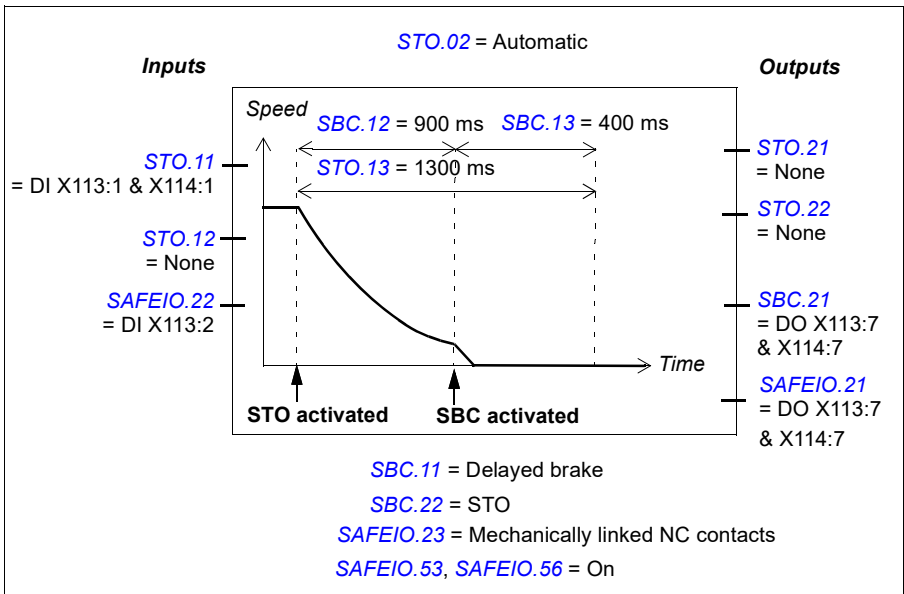

Example 2 (with an encoder): The figure below shows an example of the SBC after the STO function set-up when an encoder is used. Configure the safety encoder interface first (see section [Configuring the safety encoder interface](#) on page 315).

- STO delayed brake with positive delay 900 ms (*SBC.11 STO SBC usage = Delayed brake, SBC.12 STO SBC delay = 900 ms*)
- redundant emergency stop button connected to input (*STO.11 STO input A = DI X113:1 & X114:1*)
- automatic acknowledgement (*STO.02 STO acknowledgement = Automatic*)
- zero speed limit where STO function is completed and it can be acknowledged is 40 rpm (parameter *F SOGEN.52 Zero speed with encoder = 40 rpm*)
- the fly-start feature is not in use, that is, you cannot start the motor before it has stopped (*STO.13 Restart delay after STO = 1300 ms*)
- brake connected to redundant output, diagnostic pulses activated (*SBC.21 SBC output = DO X113:7 & X114:7, SAFEIO.53 and SAFEIO.56 = On*), *SAFEIO.21 Safety relay 1 output = DO X113:7 & X114:7*)
- STO is activated if brake feedback fails (*SBC.22 SBC feedback action = STO*)
- feedback from the brake is connected to digital input X113:2 (*SAFEIO.22 Safety relay 1 feedback = DI X113:2*)
- feedback input type NC (inverted state compared with the brake relay) (*Safety relay 1 feedback type = Mechanically linked NC contacts*).

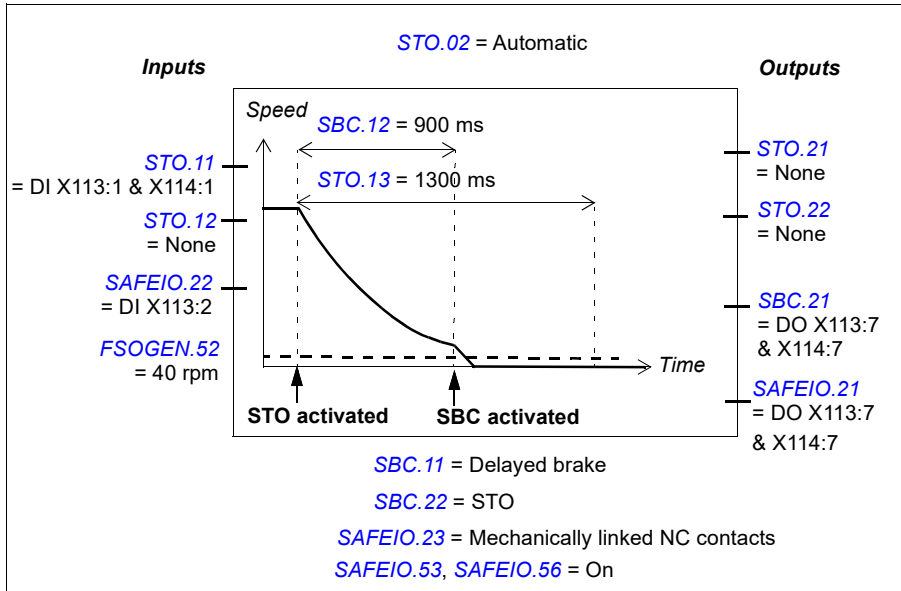

How to configure SBC before STO

For more information on the SBC before STO function, see page 75.

Example 1 (without an encoder): The figure below shows an example of the SBC before the STO set-up when an encoder is not used:

- STO delayed brake with negative delay -500 ms
(*SBC.11 STO SBC usage = Delayed brake*, *SBC.12 STO SBC delay = -500 ms*)
- redundant emergency stop button connected to input
(*STO.11 STO input A = DI X113:1 & X114:1*)
- automatic acknowledgement (*STO.02 STO acknowledgement = Automatic*)
- estimated time in which the motor brakes to a stop from the maximum speed: 1200 ms (*SBC.13 SBC time to zero speed = 1200 ms*)
- brake connected to redundant output, diagnostic pulses activated
(*SBC.21 SBC output = DO X113:7 & X114:7*, *SAFEIO.53* and *SAFEIO.56 = On*),
SAFEIO.21 Safety relay 1 output = DO X113:7 & X114:7)
- STO is activated if brake feedback fails (*SBC.22 SBC feedback action = STO*)
- brake feedback input connected to input
(*SAFEIO.22 Safety relay 1 feedback = DI X113:2*)
- feedback input type NC (inverted state compared with the brake relay)
(*SAFEIO.23 Safety relay 1 feedback type = Mechanically linked NC contacts*).

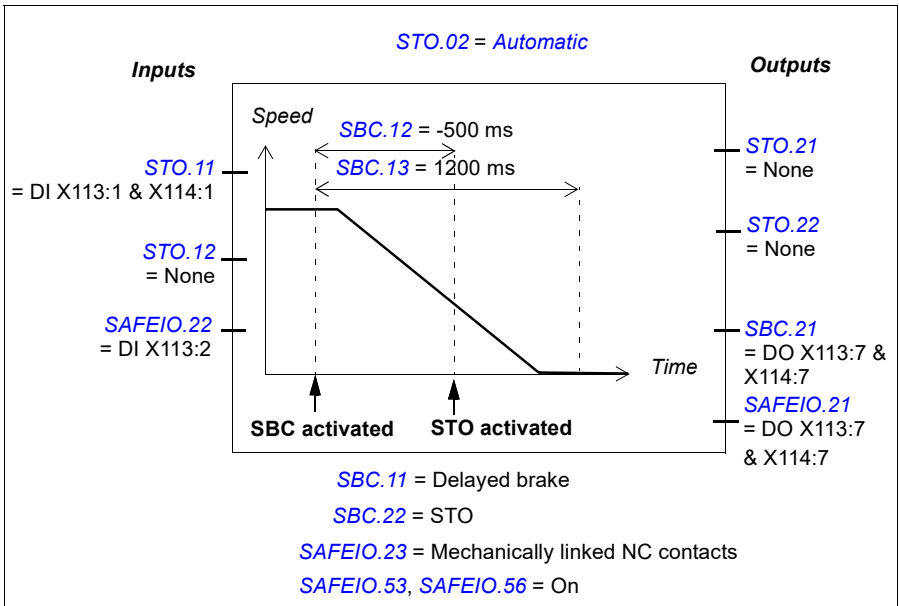

Example 2 (with an encoder): The figure below shows an example of the SBC before the STO set-up when an encoder is used. Configure the safety encoder interface first (see section [Configuring the safety encoder interface](#) on page 315).

- STO delayed brake with negative delay -500 ms
([SBC.11 STO SBC usage](#) = Delayed brake, [SBC.12 STO SBC delay](#) = -500 ms)
- redundant emergency stop button connected to input
([STO.11 STO input A](#) = DI X113:1 & X114:1)
- automatic acknowledgement ([STO.02 STO acknowledgement](#) = Automatic)
- zero speed limit where STO function is completed and it can be acknowledged is 40 rpm (parameter [FSOGEN.52 Zero speed with encoder](#) = 40 rpm)
- brake connected to redundant output, diagnostic pulses activated
([SBC.21 SBC output](#) = DO X113:7 & X114:7, [SAFEIO.53](#) and [SAFEIO.56](#) = On),
[SAFEIO.21 Safety relay 1 output](#) = DO X113:7 & X114:7)
- STO is activated if brake feedback fails ([SBC.22 SBC feedback action](#) = STO)
- brake feedback input connected to input
([SAFEIO.22 Safety relay 1 feedback](#) = DI X113:2)
- feedback input type NC (inverted state compared with the brake relay)
([SAFEIO.23 Safety relay 1 feedback type](#) = Mechanically linked NC contacts).

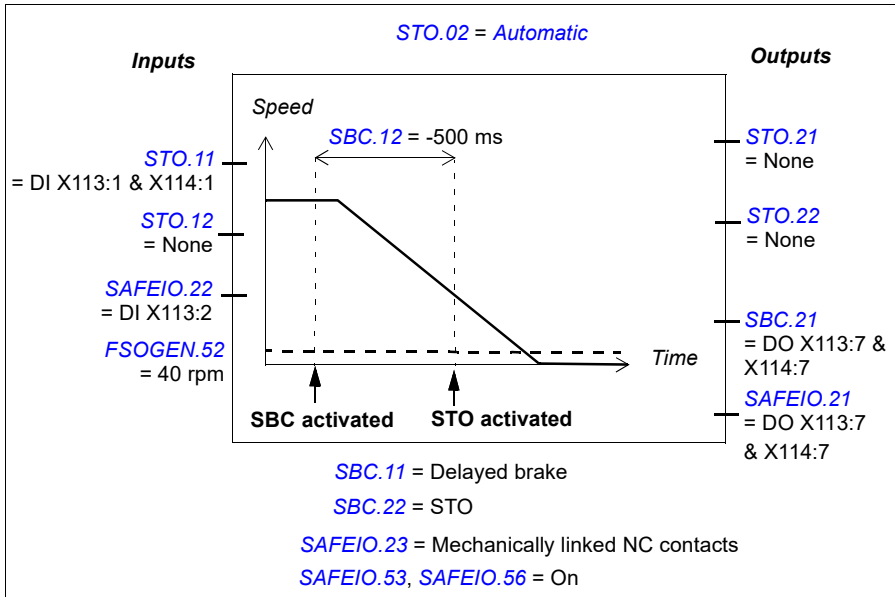

■ How to configure STO with speed limit activated SBC

This safety function requires that you use an encoder in the safety application. Configure the safety encoder interface first (see section [Configuring the safety encoder interface](#) on page 315).

Note: If you configure the STO with speed limit activated SBC function, this activates the same function in the SSE with immediate STO function (see section [How to configure SSE with immediate STO with speed limit activated SBC](#) on page 355).

For more information on the STO with speed limit activated SBC, see page 78.

Example: The figure below shows an example of a set-up of the STO with speed limit activated SBC:

- STO with speed limit activated SBC, speed limit: 60 rpm
([SBC.11 STO SBC usage](#) = *Speed limit*, [SBC.14 STO SBC speed](#) = 60 rpm)
 - zero speed limit where STO function is completed and it can be acknowledged is 40 rpm (parameter [FSOGEN.52 Zero speed with encoder](#) = 40 rpm)
 - redundant emergency stop button connected to input
([STO.11 STO input A](#) = DI X113:1 & X114:1)
 - automatic acknowledgement ([STO.02 STO acknowledgement](#) = *Automatic*)
 - the fly-start feature is in use, that is, you can restart the drive before the motor has stopped ([STO.13 Restart delay after STO](#) = 500 ms)
 - brake connected to redundant output, diagnostic pulses activated
([SBC.21 SBC output](#) = DO X113:7 & X114:7, [SAFEIO.53](#) and [SAFEIO.56](#) = On),
[SAFEIO.21 Safety relay 1 output](#) = DO X113:7 & X114:7)
 - STO is activated if brake feedback fails ([SBC.22 SBC feedback action](#) = STO)
 - brake feedback input connected to input
([SAFEIO.22 Safety relay 1 feedback](#) = DI X113:2)
 - feedback input type NC (inverted state compared with the brake relay)
([SAFEIO.23 Safety relay 1 feedback type](#) = *Mechanically linked NC contacts*).
-

- See also section [Configuring mute times](#) on page 395.

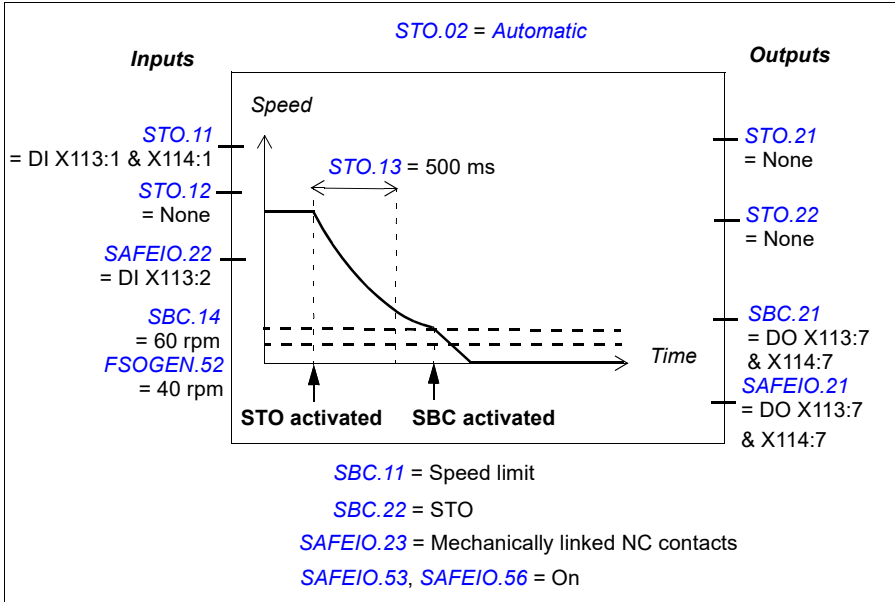

Encoder or FSE failure situations

The STO with speed limit activated SBC function (parameter [SBC.11 STO SBC usage = Speed limit](#)) requires the exact motor speed, and when this is not available, the FSO module starts to use the *Delayed brake* selection (parameter [SBC.11 STO SBC usage = Delayed brake](#)).

If parameter [S_ENCGEN.11 FSE diagnostic failure reaction = STO](#), the FSO module goes into the Fail-safe mode and activates the STO with speed limit activated SBC function with *Delayed brake*:

- If parameter [SBC.12 STO SBC delay](#) is positive, the FSO activates the SBC after this time has elapsed from the STO activation.
- If parameter [SBC.12 STO SBC delay](#) is negative or zero, the FSO activates the SBC when the encoder failure occurs.

If parameter [S_ENCGEN.11 FSE diagnostic failure reaction = No STO](#), and there are no active safety functions, the FSO module sends a warning to the drive. If there are active safety functions when the FSO module detects the failure, the FSO module goes into the Fail-safe mode and activates the STO with speed limit activated SBC function with *Delayed brake* (see above).

If parameter [S_ENCGEN.11 FSE diagnostic failure reaction = Est switch not active load](#), the FSO module continues operation by using the estimated motor speed until the encoder failure is fixed and the exact motor speed is available again. **Note:** Safe speed estimate cannot be used with a DCS880 drive.

- If the encoder failure occurs **before** the STO function is activated, the FSO continues operation using the estimated motor speed and activates the STO and SBC function with *Delayed brake* (see section [How to configure SBC after STO](#) on page [335](#)) when the STO function request is received.
 - If the encoder failure occurs **while** the STO function is already active, but the [STO SBC speed](#) has not been reached yet, the FSO module starts to use the *Delayed brake* and activates the SBC accordingly:
 - If parameter [SBC.12 STO SBC delay](#) is positive, the FSO activates the SBC after this time has elapsed from the STO activation.
 - If parameter [SBC.12 STO SBC delay](#) is negative or zero, the FSO activates the SBC when the encoder failure occurs.
-

Configuring SS1

To configure the SS1 function, set the FSO parameters listed below to appropriate values using the Drive Composer pro PC tool. See parameter group [SS1](#) on page [422](#).

For more information on the SS1 function, see page [80](#).

■ How to configure SS1 with time monitoring (SS1-t)

Example: The figure below shows an example of an SS1-t set-up:

- SS1 function activated ([SS1.01 SS1 activity and version](#) = Version 1)
 - SAR1 emergency ramp ([200.112 SAR1 ramp time to zero](#), always with the SS1 function - see section [Configuring SAR](#) on page [363](#))
 - SS1 with time monitored ramp ([SS1.13 SS1 type](#) = SS1-t)
 - delay for STO activation after SS1 request: 2000 ms ([SS1.14 SS1-t delay for STO](#) = 2000 ms)
 - automatic acknowledgement ([STO.02 STO acknowledgement](#) = Automatic)
 - redundant emergency stop button connected to input ([SS1.11 SS1 input A](#) = DI X113:1 & X114:1)
 - single output connected ([SS1.21 SS1 output](#) = DO X114:9)
 - zero speed limit where SS1 function is completed and drive STO activated is 90 rpm ([FSOGEN.51 Zero speed without encoder](#) = 90 rpm)
(when an encoder is used: [FSOGEN.52 Zero speed with encoder](#) = 90 rpm)
 - delay for activating STO after the zero speed limit has been reached: 0 ms ([SS1.15 SS1-r ramp zero speed delay for STO](#) = 0 ms)
 - speed limit activated brake not in use ([SBC.15 SSE/SS1 SBC speed](#) = 0 rpm).
 - See also section [Configuring mute times](#) on page [395](#).
-

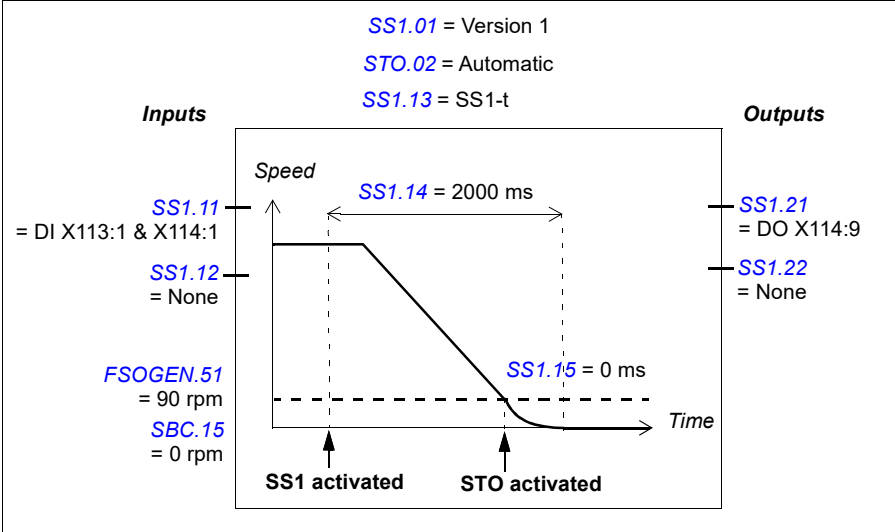

■ How to configure SS1 with ramp monitoring (SS1-r)

Example: The figure below shows an example of the SS1-r function set-up:

- SS1 function activated (*SS1.01 SS1 activity and version = Version 1*)
- SAR1 emergency ramp (*200.112 SAR1 ramp time to zero*, always with the SS1 function - see section *Configuring SAR* on page 363)
- SS1 with monitored ramp (*SS1.13 SS1 type = SS1-r*). See also section *How to configure SARn* on page 363.
- automatic acknowledgement (*STO.02 STO acknowledgement = Automatic*)
- redundant emergency stop button connected to input (*SS1.11 SS1 input A = DI X113:1 & X114:1*)
- single output connected (*SS1.21 SS1 output = DO X114:9*)
- zero speed limit where SS1 function is completed and drive STO activated is 90 rpm (*FSOGEN.51 Zero speed without encoder = 90 rpm*)
(when an encoder is used: *FSOGEN.52 Zero speed with encoder = 90 rpm*)
- delay for activating STO after the zero speed limit has been reached: 0 ms (*SS1.15 SS1-r ramp zero speed delay for STO = 0 ms*)
- speed limit activated brake not in use (*SBC.15 SSE/SS1 SBC speed = 0 rpm*).
- See also section *Configuring mute times* on page 395.

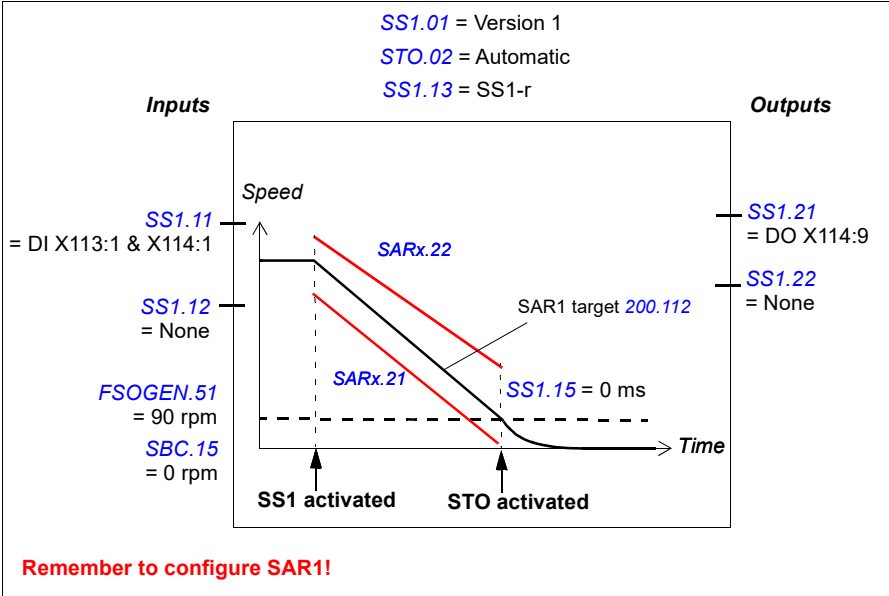

■ How to configure SS1 with speed limit activated SBC

Note: If you configure the SS1 with speed limit activated SBC function, this activates the same function in the SSE function (see section [How to configure SSE with speed limit activated SBC](#) on page 358). This does not activate the SBC in the STO function. If necessary, configure the SBC also in the STO function (see section [Configuring STO](#) on page 333). See also the note on page 50.

Example 1: The figure below shows an example of the SS1-t function with speed limit activated SBC set-up:

- SS1 function activated ([SS1.01 SS1 activity and version](#) = Version 1)
 - SS1 with time monitored ramp ([SS1.13 SS1 type](#) = SS1-t)
 - SAR1 emergency ramp ([200.112 SAR1 ramp time to zero](#), always with the SS1 function - see section [Configuring SAR](#) on page 363)
 - delay for STO activation after SS1 request: 2000 ms ([SS1.14 SS1-t delay for STO](#) = 2000 ms)
 - automatic acknowledgement ([STO.02 STO acknowledgement](#) = Automatic)
 - redundant emergency stop button connected to input ([SS1.11 SS1 input A](#) = DI X113:1 & X114:1)
 - single output connected ([SS1.21 SS1 output](#) = DO X114:9)
 - brake connected to redundant output, diagnostic pulses activated ([SBC.21 SBC output](#) = DO X113:7 & X114:7, [SAFEIO.53](#) and [SAFEIO.56](#) = On), [SAFEIO.21 Safety relay 1 output](#) = DO X113:7 & X114:7)
 - speed limit activated brake in use, speed below which the brake and STO are activated: 180.0 rpm ([SBC.15 SSE/SS1 SBC speed](#) = 180 rpm)
 - delay for activating STO after brake is zero (STO and SBC are activated at the same time) ([SBC.12 STO SBC delay](#) = 0 ms)
 - delay for activating the brake and STO after the SBC speed limit has been reached: 0 ms ([SS1.15 SS1-r ramp zero speed delay for STO](#) = 0 ms)
 - when no encoder is in use: delay for defining the safety function as completed, that is, an estimated time in which the motor brakes to a stop from the maximum speed: 1200 ms ([SBC.13 SBC time to zero speed](#) = 1200 ms)
 - STO is activated if brake feedback fails ([SBC.22 SBC feedback action](#) = STO)
 - brake feedback input connected to input ([SAFEIO.22 Safety relay 1 feedback](#) = DI X113:2)
 - feedback input type NC (inverted state compared with the brake relay) ([SAFEIO.23 Safety relay 1 feedback type](#) = Mechanically linked NC contacts).
 - See also section [Configuring mute times](#) on page 395.
-

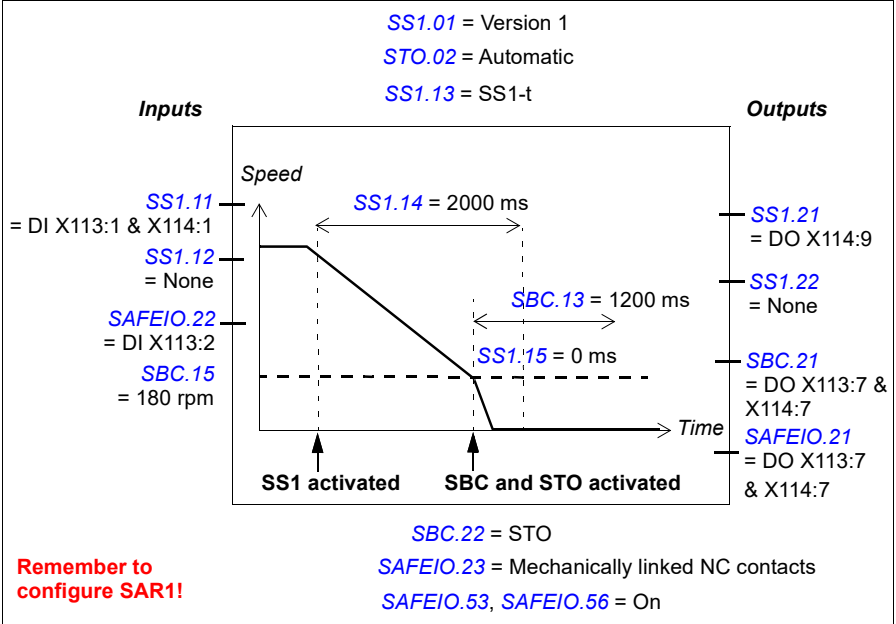

Example 2: The figure below shows an example of the SS1-r function with speed limit activated SBC set-up:

- SS1 function activated (*SS1.01 SS1 activity and version = Version 1*)
 - SAR1 emergency ramp (*200.112 SAR1 ramp time to zero*, always with the SS1 function - see section *Configuring SAR* on page 363)
 - SS1 with monitored ramp (*SS1.13 SS1 type = SS1-r*). See also section *How to configure SARn* on page 363.
 - automatic acknowledgement (*STO.02 STO acknowledgement = Automatic*)
 - redundant emergency stop button connected to input (*SS1.11 SS1 input A = DI X113:1 & X114:1*)
 - single output connected (*SS1.21 SS1 output = DO X114:9*)
 - brake connected to redundant output, diagnostic pulses activated (*SBC.21 SBC output = DO X113:7 & X114:7*, *SAFEIO.53* and *SAFEIO.56 = On*), *SAFEIO.21 Safety relay 1 output = DO X113:7 & X114:7*)
 - speed limit activated brake in use, speed limit below which the brake and STO are activated: 180.0 rpm (*SBC.15 SSE/SS1 SBC speed = 180 rpm*)
 - delay for activating STO after brake is zero (STO and SBC are activated at the same time) (*SBC.12 STO SBC delay = 0 ms*)
 - delay for activating the brake and STO after the SBC speed limit has been reached: 0 ms (*SS1.15 SS1-r ramp zero speed delay for STO = 0 ms*)
 - when no encoder is in use: delay for defining the safety function as completed, that is, an estimated time in which the motor brakes to a stop from the maximum speed: 1200 ms (*SBC.13 SBC time to zero speed = 1200 ms*)
 - STO is activated if brake feedback fails (*SBC.22 SBC feedback action = STO*)
 - brake feedback input connected to input (*SAFEIO.22 Safety relay 1 feedback = DI X113:2*)
 - feedback input type NC (inverted state compared with the brake relay) (*SAFEIO.23 Safety relay 1 feedback type = Mechanically linked NC contacts*).
 - See also section *Configuring mute times* on page 395.
-

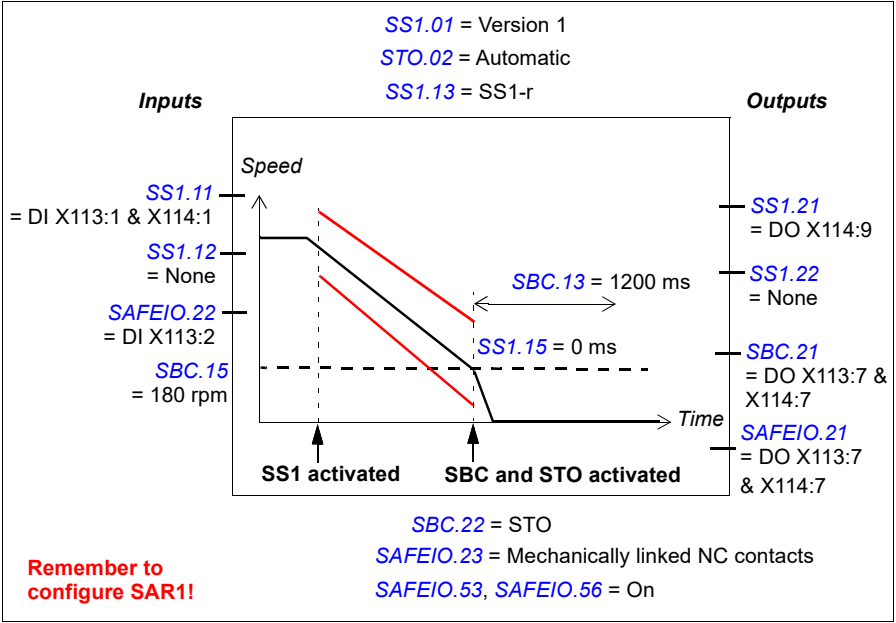

■ How to configure SS1 with speed limit activated SBC, SBC before STO

Note: If you configure the SS1 with speed limit activated SBC, SBC before STO function, this activates the same function in the SSE function (see section [How to configure SSE with speed limit activated SBC](#) on page 358). This does not activate the SBC in the STO function. If necessary, configure the SBC also in the STO function (see section [Configuring STO](#) on page 333). See also the note on page 50.

Example 1: The figure below shows an example of the SS1-t function with speed limit activated SBC, SBC before STO set-up:

- SS1 function activated ([SS1.01 SS1 activity and version](#) = Version 1)
 - SS1 with time monitored ramp ([SS1.13 SS1 type](#) = SS1-t)
 - SAR1 emergency ramp ([200.112 SAR1 ramp time to zero](#), always with the SS1 function - see section [Configuring SAR](#) on page 363)
 - delay for STO activation after SS1 request: 2000 ms ([SS1.14 SS1-t delay for STO](#) = 2000 ms)
 - automatic acknowledgement ([STO.02 STO acknowledgement](#) = Automatic)
 - redundant emergency stop button connected to input ([SS1.11 SS1 input A](#) = DI X113:1 & X114:1)
 - single output connected ([SS1.21 SS1 output](#) = DO X114:9)
 - brake connected to redundant output, diagnostic pulses activated ([SBC.21 SBC output](#) = DO X113:7 & X114:7, [SAFEIO.53](#) and [SAFEIO.56](#) = On), [SAFEIO.21 Safety relay 1 output](#) = DO X113:7 & X114:7)
 - speed limit activated brake in use, speed below which the brake and STO are activated: 180.0 rpm ([SBC.15 SSE/SS1 SBC speed](#) = 180 rpm)
 - delay for activating STO after brake: -300 ms (only a negative delay is possible, the SBC is activated before STO) ([SBC.12 STO SBC delay](#) = -300 ms)
-

Note: The same SBC delay is used in the STO and SS1/SSE functions.

- delay for activating the brake after the SBC speed limit has been reached: 0 ms (*SS1.15 SS1-r ramp zero speed delay for STO = 0 ms*, not shown in the figure)
- when an encoder is used: zero speed limit to define the safety function as completed: 90 rpm (*F SOGEN.52 Zero speed with encoder = 90 rpm*, not shown in the figure)
- when an encoder is not used: delay to define the safety function as completed, that is, estimated time in which the motor brakes to a stop from the maximum speed: 1200 ms (*SBC.13 SBC time to zero speed = 1200 ms*)
- STO is activated if brake feedback fails (*SBC.22 SBC feedback action = STO*)
- brake feedback input connected to input (*SAFEIO.22 Safety relay 1 feedback = DI X113:2*)
- feedback input type NC (inverted state compared with the brake relay) (*SAFEIO.23 Safety relay 1 feedback type = Mechanically linked NC contacts*).
- See also section *Configuring mute times* on page 395.

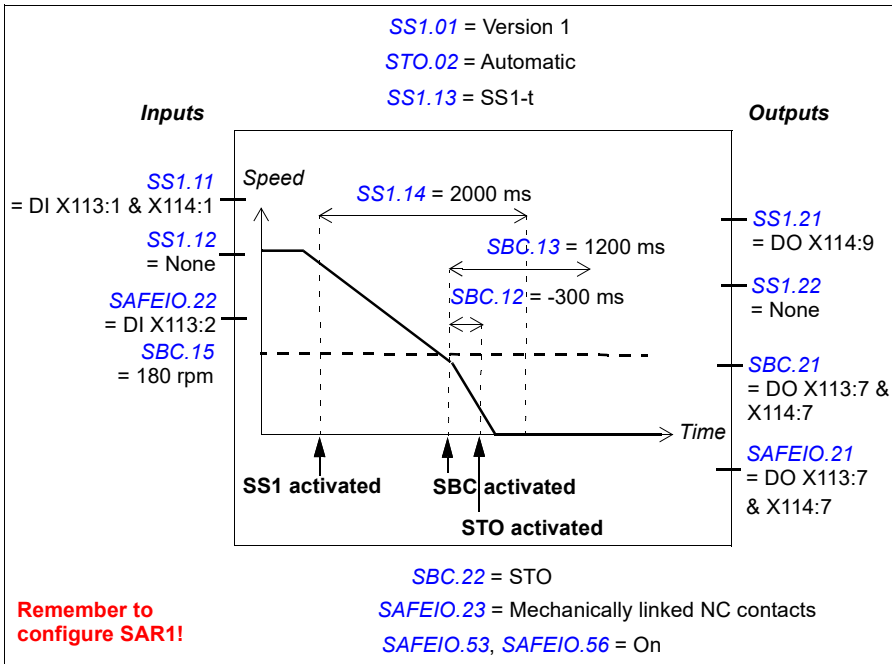

Note: This figure shows the case when an encoder is not used.

Example 2: The figure below shows an example of the SS1-r function with speed limit activated SBC, SBC before STO set-up:

- SS1 function activated (*SS1.01 SS1 activity and version = Version 1*)
- SAR1 emergency ramp (*200.112 SAR1 ramp time to zero*, always with the SS1 function - see section *Configuring SAR* on page 363)
- SS1 with monitored ramp (*SS1.13 SS1 type = SS1-r*). See also section *How to configure SARn* on page 363.
- automatic acknowledgement (*STO.02 STO acknowledgement = Automatic*)
- redundant emergency stop button connected to input (*SS1.11 SS1 input A = DI X113:1 & X114:1*)
- single output connected (*SS1.21 SS1 output = DO X114:9*)
- brake connected to redundant output, diagnostic pulses activated (*SBC.21 SBC output = DO X113:7 & X114:7*, *SAFEIO.53* and *SAFEIO.56 = On*, *SAFEIO.21 Safety relay 1 output = DO X113:7 & X114:7*)
- speed limit activated brake in use, speed limit below which the brake is activated: 180.0 rpm (*SBC.15 SSE/SS1 SBC speed = 180 rpm*)
- delay for activating STO after brake: -300 ms (only a negative delay is possible, the SBC is activated before STO) (*SBC.12 STO SBC delay = -300 ms*)

Note: The same SBC delay is used in the STO and SS1/SSE functions.

- delay for activating the brake after the SBC speed limit has been reached: 0 ms (*SS1.15 SS1-r ramp zero speed delay for STO = 0 ms*, not shown in the figure)
 - when an encoder is used: zero speed limit to define the safety function as completed: 90 rpm (*FSGEN.52 Zero speed with encoder = 90 rpm*, not shown in the figure)
 - when an encoder is not used: delay to define the safety function as completed, that is, estimated time in which the motor brakes to a stop from the maximum speed: 1200 ms (*SBC.13 SBC time to zero speed = 1200 ms*)
 - STO is activated if brake feedback fails (*SBC.22 SBC feedback action = STO*)
 - brake feedback input connected to input (*SAFEIO.22 Safety relay 1 feedback = DI X113:2*)
 - feedback input type NC (inverted state compared with the brake relay) (*SAFEIO.23 Safety relay 1 feedback type = Mechanically linked NC contacts*).
 - See also section *Configuring mute times* on page 395.
-

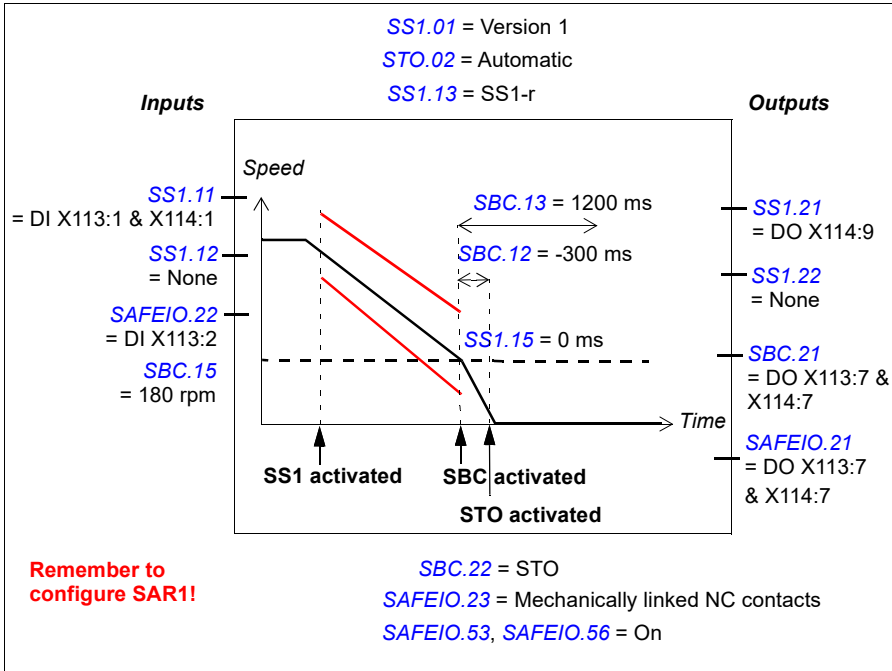

Note: This figure shows the case when an encoder is not used.

■ Related safety functions

The SS1 function uses SAR1 ramp parameters. See section [Configuring SAR](#) on page 363.

The FSO module activates the STO function if the motor speed hits a monitoring limit (time or ramp monitoring). See section [Configuring STO](#) on page 333.

Configuring SSE

To configure the SSE function, set the FSO parameters listed below to appropriate values using the Drive Composer pro PC tool. See parameter groups [SSE](#) on page 419 and [SBC](#) on page 414.

For more information on the SSE function, see page 107.

Note: Always set the parameters related to the SSE function to have the correct trip limit hit and fault reaction behavior. For example, the FSO module activates the SSE function if an I/O failure occurs.

How to configure SSE with immediate STO

Example 1 (without an encoder): The figure below shows an example of the SSE function with immediate STO set-up when an encoder is not used:

- drive STO is activated immediately after the SSE request ([SSE.13 SSE function](#) = *Immediate STO*)
- automatic acknowledgement ([STO.02 STO acknowledgement](#) = *Automatic*)
- redundant emergency stop button connected to input ([SSE.11 SSE input A](#) = *DI X113:1 & X114:1*)
- no outputs connected
- delay for restarting the drive: 1500 ms. This is the estimated time in which the motor coasts to a stop from the maximum speed. ([STO.14 Time to zero speed with STO and modoff](#) = *1500 ms*)
- no brake ([SBC.11 STO SBC usage](#) = *None*).

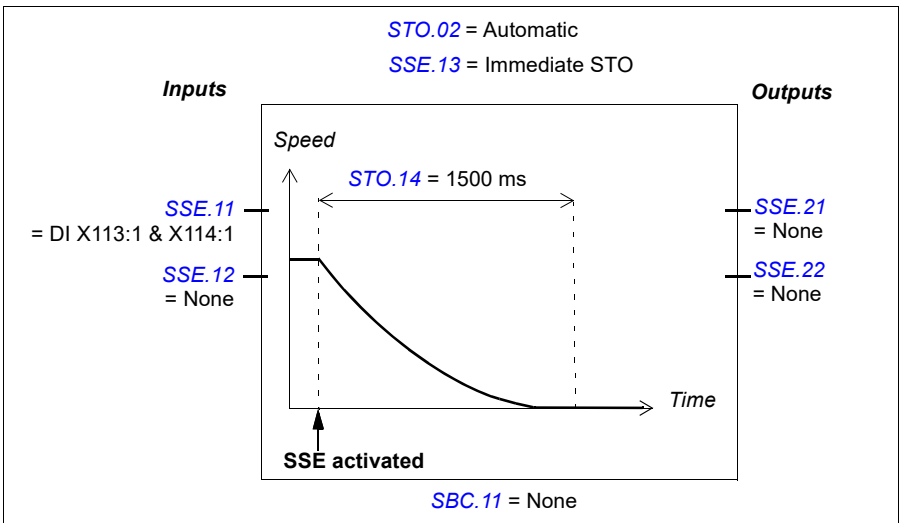

Example 2 (with an encoder): The figure below shows an example of the SSE function with immediate STO set-up when an encoder is used. Configure the safety encoder interface first (see section [Configuring the safety encoder interface](#) on page 315).

- drive STO is activated immediately after the SSE request ([SSE.13 SSE function = Immediate STO](#))
- automatic acknowledgement ([STO.02 STO acknowledgement = Automatic](#))
- redundant emergency stop button connected to input ([SSE.11 SSE input A = DI X113:1 & X114:1](#))
- no outputs connected
- zero speed limit where STO function is completed and it can be acknowledged is 40 rpm (parameter [FSOGEN.52 Zero speed with encoder = 40 rpm](#))
- no brake ([SBC.11 STO SBC usage = None](#)).

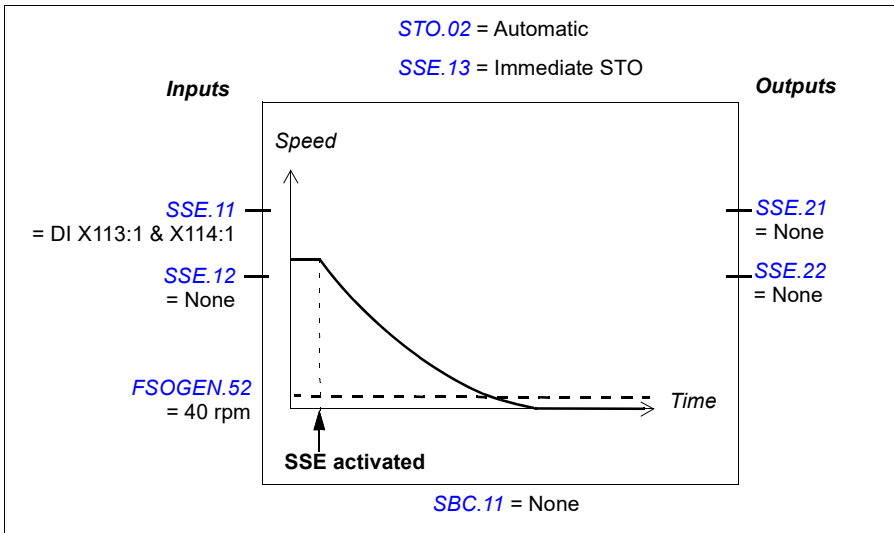

■ How to configure SSE with immediate STO, SBC after or before STO

The configuration is identical to the SBC after or before STO functions with these differences:

- parameter [STO.13 Restart delay after STO](#) is not used
- SSE input parameters ([SSE.11 SSE input A](#) and [SSE.12 SSE input B](#)) are used instead of STO input parameters
- SSE output parameters ([SSE.21 SSE output](#) and [SSE.22 SSE completed output](#)) are used instead of STO output parameters.

See sections [How to configure SBC after STO](#) on page 335 and [How to configure SBC before STO](#) on page 337.

For more information on the SSE with immediate STO and SBC after STO function, see page 110.

For more information on the SSE with immediate STO and SBC before STO function, see page 113.

■ How to configure SSE with immediate STO with speed limit activated SBC

This safety function requires that an encoder is used. Configure the safety encoder interface first (see section [Configuring the safety encoder interface](#) on page 315).

The configuration is identical to the STO with speed limit activated SBC function with these differences:

- parameter [STO.13 Restart delay after STO](#) is not used
- SSE input parameters ([SSE.11 SSE input A](#) and [SSE.12 SSE input B](#)) are used instead of STO input parameters
- SSE output parameters ([SSE.21 SSE output](#) and [SSE.22 SSE completed output](#)) are used instead of STO output parameters.

Note: If you configure the SSE with immediate STO with speed limit activated SBC function, this activates the same function in the STO function (see section [How to configure STO with speed limit activated SBC](#) on page 339).

For more information on the SSE with immediate STO with speed limit activated SBC function, see page 116.

■ How to configure SSE with time monitoring

For more information on the SSE function with time monitoring, see page [117](#).

Example: The figure below shows an example of the SSE function with time monitoring set-up:

- SAR0 emergency ramp ([200.102 SAR0 ramp time to zero](#), always with the SSE function - see section [Configuring SAR](#) on page [363](#))
- SSE with time monitored ramp ([SSE.13 SSE function = Emergency ramp](#), [SSE.14 SSE monitoring method = Time](#))
- delay for STO activation after SSE request: 2000 ms ([SSE.15 SSE delay for STO = 2000 ms](#))
- automatic acknowledgement ([STO.02 STO acknowledgement = Automatic](#))
- redundant emergency stop button connected to input ([SSE.11 SSE input A = DI X113:1 & X114:1](#))
- single output connected ([SSE.21 SSE output = DO X113:9](#))
- zero speed limit where SSE function is completed and drive STO activated is 90 rpm ([FSOGEN.51 Zero speed without encoder = 90 rpm](#)) (when an encoder is used: [FSOGEN.52 Zero speed with encoder = 90 rpm](#))
- delay for activating the drive STO after the speed limit has been reached: 0 ms ([SSE.16 SSE ramp zero speed delay for STO = 0 ms](#))
- speed limit activated brake not in use ([SBC.15 SSE/SS1 SBC speed = 0 rpm](#))
- See also section [Configuring mute times](#) on page [395](#).

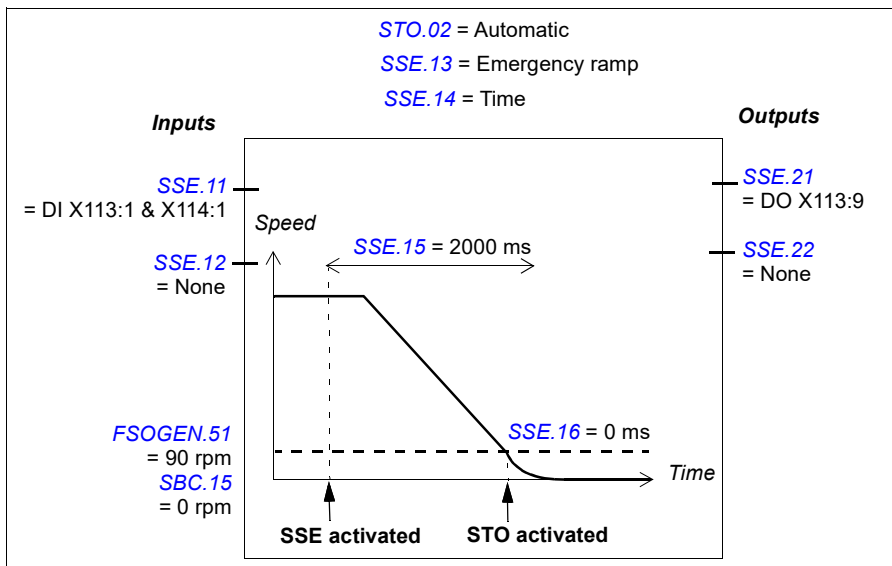

How to configure SSE with ramp monitoring

For more information on the SSE function with ramp monitoring, see page 121.

Example: The figure below shows an example of the SSE function with ramp monitoring set-up:

- SAR0 emergency ramp (*200.102 SAR0 ramp time to zero*, always with the SSE function - see section *Configuring SAR* on page 363)
- SSE with emergency ramp (*SSE.13 SSE function = Emergency ramp*)
- SSE with monitored ramp (*SSE.14 SSE monitoring method = Ramp*). See also section *Configuring SAR* on page 363.
- redundant emergency stop button connected to input (*SSE.11 SSE input A = DI X113:1 & X114:1*)
- single output connected (*SSE.21 SSE output = DO X113:9*)
- zero speed limit where SSE function is completed and drive STO activated is 90 rpm (*F SOGEN.51 Zero speed without encoder = 90 rpm*) (when an encoder is used: *F SOGEN.52 Zero speed with encoder = 90 rpm*)
- delay for activating the drive STO after the zero speed limit has been reached: 0 ms (*SSE.16 SSE ramp zero speed delay for STO = 0 ms*)
- speed limit activated brake not in use (*SBC.15 SSE/SS1 SBC speed = 0 rpm*).
- See also section *Configuring mute times* on page 395.

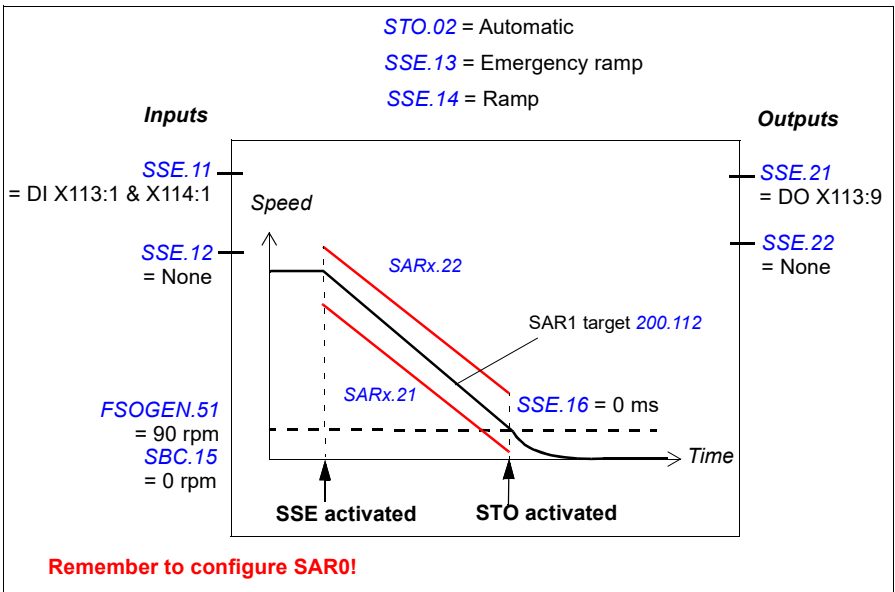

■ How to configure SSE with speed limit activated SBC

Note: If you configure the SSE with speed limit activated SBC function, this activates the same function in the SS1 function (see section [How to configure SS1 with speed limit activated SBC](#) on page 345). This does not activate the SBC in the STO function. If necessary, configure the SBC also in the STO function (see section [Configuring STO](#) on page 333). See also the note on page 50.

Example 1: The figure below shows an example of the SSE with emergency ramp function with speed limit activated SBC set-up with time monitoring:

- SSE with emergency ramp ([SSE.13 SSE function = Emergency ramp](#))
 - SAR0 emergency ramp ([200.102 SAR0 ramp time to zero](#), always with the SSE function, see also section [Configuring SAR](#) on page 363)
 - time monitored ramp ([SSE.14 SSE monitoring method = Time](#))
 - delay for STO activation after SSE request: 2000 ms ([SSE.15 SSE delay for STO = 2000 ms](#))
 - redundant emergency stop button connected to input ([SSE.11 SSE input A = DI X113:1 & X114:1](#))
 - single output connected ([SSE.21 SSE output = DO X113:9](#))
 - brake connected to redundant output, diagnostic pulses activated ([SBC.21 SBC output = DO X113:7 & X114:7](#), [SAFEIO.53](#) and [SAFEIO.56 = On](#), [SAFEIO.21 Safety relay 1 output = DO X113:7 & X114:7](#))
 - speed limit activated brake in use, speed below which the brake and STO are activated 240.0 rpm ([SBC.15 SSE/SS1 SBC speed = 240 rpm](#))
 - delay for activating STO after brake is zero (STO and SBC are activated at the same time) ([SBC.12 STO SBC delay = 0 ms](#))
 - delay for activating the brake and drive STO after the speed limit has been reached 0 ms ([SSE.16 SSE ramp zero speed delay for STO = 0 ms](#))
 - STO is activated if brake feedback fails ([SBC.22 SBC feedback action = STO](#))
 - brake feedback input connected to input ([SAFEIO.22 Safety relay 1 feedback = DI X113:2](#))
 - feedback input type NC (inverted state compared with the brake relay) ([SAFEIO.23 Safety relay 1 feedback type = Mechanically linked NC contacts](#)).
 - See also section [Configuring mute times](#) on page 395.
-

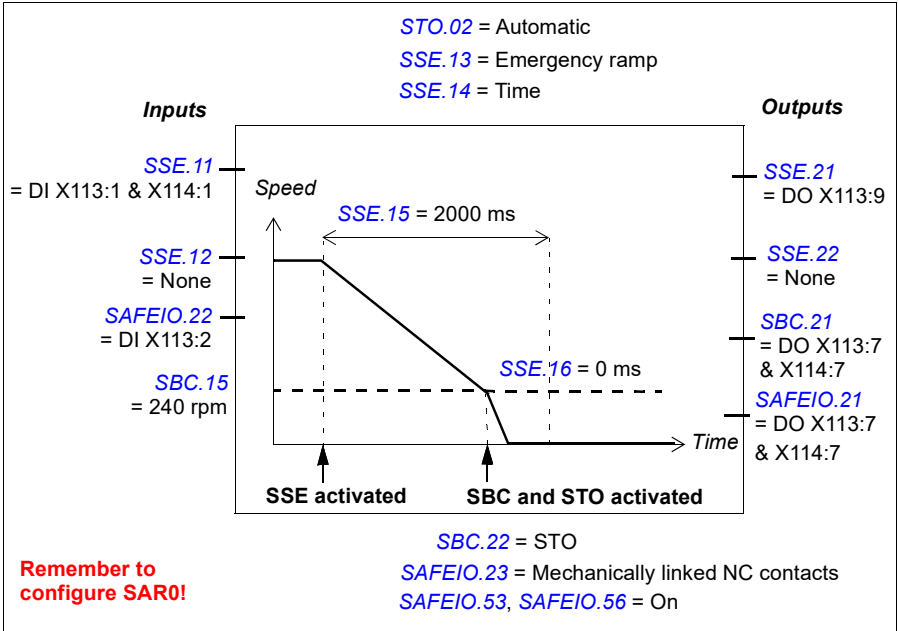

Example 2: The figure below shows an example of the SSE with emergency ramp function with speed limit activated SBC set-up with ramp monitoring:

- SSE with emergency ramp ([SSE.13 SSE function = Emergency ramp](#))
 - SAR0 emergency ramp ([200.102 SAR0 ramp time to zero](#), always with the SSE function - see section [Configuring SAR](#) on page 363)
 - SAR0 monitored ramp ([SSE.14 SSE monitoring method = Ramp](#), see also section [Configuring SAR](#) on page 363)
 - redundant emergency stop button connected to input ([SSE.11 SSE input A = DI X113:1 & X114:1](#))
 - single output connected ([SSE.21 SSE output = DO X113:9](#))
 - brake connected to redundant output, diagnostic pulses activated ([SBC.21 SBC output = DO X113:7 & X114:7](#), [SAFEIO.53](#) and [SAFEIO.56 = On](#), [SAFEIO.21 Safety relay 1 output = DO X113:7 & X114:7](#))
 - speed limit activated brake in use, speed below which the brake and STO are activated 240.0 rpm ([SBC.15 SSE/SS1 SBC speed = 240 rpm](#))
 - delay for activating STO after brake is zero (STO and SBC are activated at the same time) ([SBC.12 STO SBC delay = 0 ms](#))
 - delay for activating the brake and drive STO after the speed limit has been reached 0 ms ([SSE.16 SSE ramp zero speed delay for STO = 0 ms](#))
 - STO is activated if brake feedback fails ([SBC.22 SBC feedback action = STO](#))
 - brake feedback input connected to input ([SAFEIO.22 Safety relay 1 feedback = DI X113:2](#))
 - feedback input type NC (inverted state compared with the brake relay) ([SAFEIO.23 Safety relay 1 feedback type = Mechanically linked NC contacts](#)).
 - See also section [Configuring mute times](#) on page 395.
-

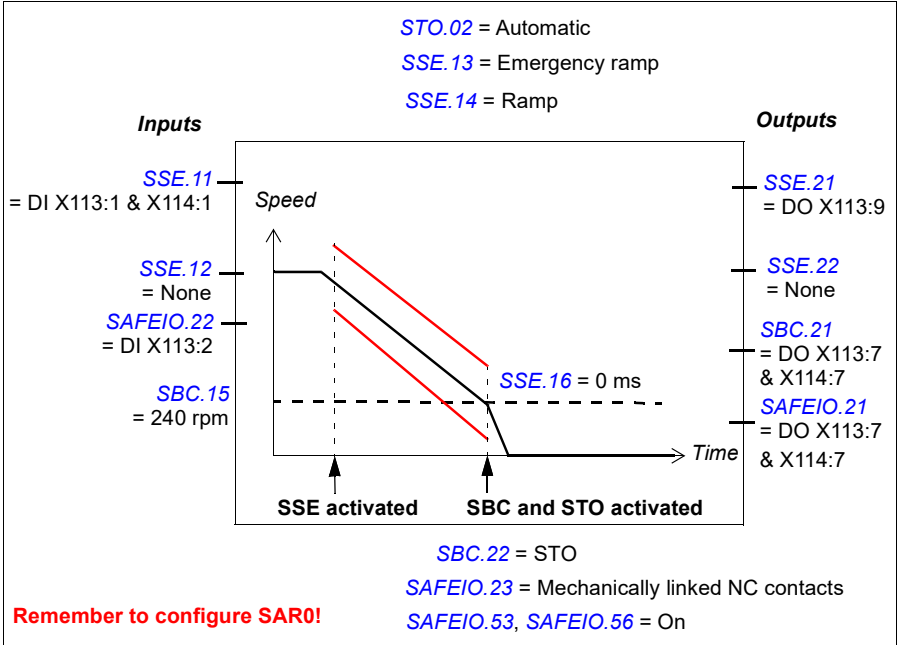

■ How to configure SSE with speed limit activated SBC, SBC before STO

The configuration of the SSE with speed limit activated SBC, SBC before STO is identical to the configuration of the same SS1 function with these differences:

- SSE input parameters ([SSE.11 SSE input A](#) and [SSE.12 SSE input B](#)) are used instead of SS1 input parameters
- SSE output parameters ([SSE.21 SSE output](#) and [SSE.22 SSE completed output](#)) are used instead of SS1 output parameters.
- type of the SSE function must be set: SSE with emergency ramp ([SSE.13 SSE function = Emergency ramp](#))
- SAR0 emergency ramp and monitoring limits are used instead of SAR1 parameters (see section [Configuring SAR](#) on page 363).
- monitoring method is set with parameter ([SSE.14 SSE monitoring method = Time or Ramp](#))
- delay for STO activation after SSE request is set with parameter [SSE.15 SSE delay for STO](#)
- delay for activating the brake after the speed limit has been reached is set with parameter [SSE.16 SSE ramp zero speed delay for STO](#).

Note: If you configure the SSE with speed limit activated SBC function, this activates the same function in the SS1 function (see section [How to configure SS1 with speed limit activated SBC, SBC before STO](#) on page 349). This does not activate the SBC in the STO function. If necessary, configure the SBC also in the STO function (see section [Configuring STO](#) on page 333). See also the note on page 50.

For more information on the SSE with speed limit activated SBC, SBC before STO SBC function, see page 133.

■ Related safety functions

The SSE function uses SAR0 ramp parameters. See section [Configuring SAR](#) on page 363.

The FSO module activates the STO function if the motor speed hits a monitoring limit (SSE with time or ramp monitoring). See section [Configuring STO](#) on page 333.

Configuring SAR

How to configure SARn

To configure the SARn (n = 0...1), set the FSO parameters listed below to appropriate values using the Drive Composer pro PC tool. See parameter groups [Safety](#) on page 404 and [SARx](#) on page 432. See also section [Ramp monitoring](#) on page 57.

Example: The figure below shows an example of a SAR1 monitoring set-up:

- SAR1
- ramp time from Scaling speed to zero: 1000 ms
([200.112 SAR1 ramp time to zero](#) = 1000 ms)
- Scaling speed: 1500 rpm ([200.202 SAR speed scaling](#) = 1500 rpm)
- initial range for monitoring: 100 ms ([SARx.02 SAR initial allowed range](#) = 100 ms)
- minimum allowed ramp time: 500 ms
([SARx.21 SAR1 min ramp time to zero](#) = 500 ms)
- maximum allowed ramp time: 1000 ms
([SARx.12 SAR1 max ramp time to zero](#) = 1500 ms).

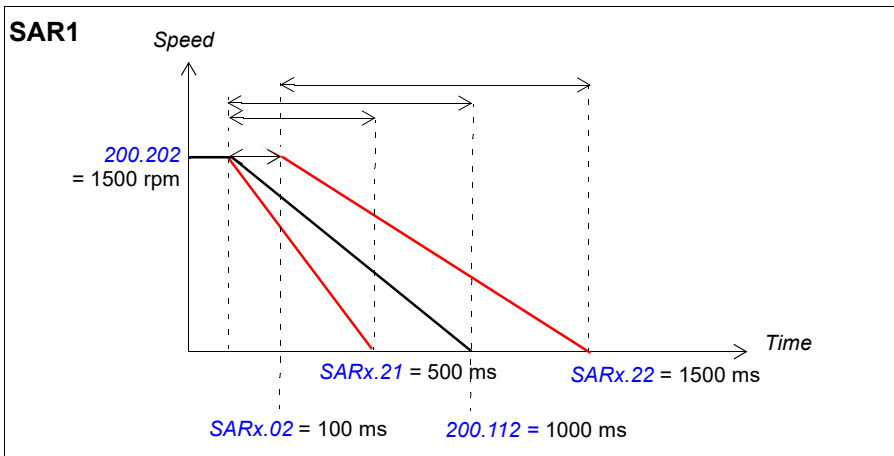

Note: If you use SAR1 in several safety functions at the same time, tune it according to the function which requires the tightest monitoring range.

Configuring SLS

To configure the SLS_n (n = 1...4), set the FSO parameters listed below to appropriate values using the Drive Composer pro PC tool. See parameter groups [Safety](#) on page 404 and [SLSx](#) on page 424.

For more information on the SLS function, see page 141.

Depending on the application, set the negative and positive SLS and SLS trip limits separately.

■ How to configure SLS_n with time monitoring

Example: The figure below shows an example of the SLS1 function with time monitoring set-up:

- SLS1 function activated ([200.21 SLS1 activity and version](#) = Version 1)
- time monitored deceleration ramp
([SLSx.03 SLS activation monitoring method](#) = Time)
- deceleration ramp according to drive parameters (always with time monitoring)
- SLS activation delay: 2000 ms ([SLSx.04 SLS time delay](#) = 2000 ms)
- automatic acknowledgement ([SLSx.02 SLS acknowledgement](#) = Automatic)
- redundant SLS activation button connected to input
([SLSx.11 SLS1 input A](#) = DI X113:2 & X114:2)
- single output connected ([SLSx.15 SLS1 output A](#) = DO X114:7)
- positive limits: SLS 1200.0 rpm, trip limit 1320.0 rpm
([200.23 SLS1 limit positive](#) = 1200 rpm,
[SLSx.14 SLS1 trip limit positive](#) = 1320 rpm).
- negative limits: SLS -900.0 rpm, trip limit -1020.0 rpm
([200.22 SLS1 limit negative](#) = -900 rpm,
[SLSx.13 SLS1 trip limit negative](#) = -1020 rpm).
- See also section [Configuring mute times](#) on page 395.

Note: The difference between the SLS limit and the corresponding SLS trip limit must be at least 0.1 rpm.

Note: If you also use the SMS function, the SLS trip limits positive and negative must be below the speed defined by parameter [SMS trip limit positive](#) and above the speed defined by parameter [SMS trip limit negative](#), respectively.

SLS1

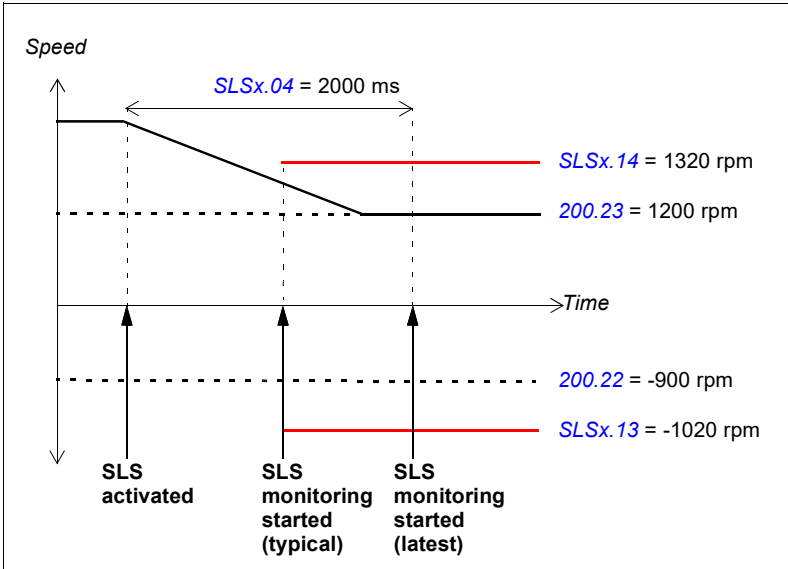

200.21 = Version 1
 $SLSx.02$ = Automatic
 $SLSx.03$ = Time

Inputs

$SLSx.11$
 = DI X113:2 &
 X114:2

$SLSx.12$
 = None

Outputs

$SLSx.15$
 = DO X114:7

$SLSx.16$
 = None

■ How to configure SLSn with ramp monitoring

Example: The figure below shows an example of the SLS2 function with ramp monitoring set-up:

- SLS2 function activated ([200.31 SLS2 activity and version](#) = Version 1)
- monitored deceleration ramp ([SLSx.03 SLS activation monitoring method](#) = Ramp)
- deceleration ramp and monitoring limits according SAR1 parameters (see section [Configuring SAR](#) on page 363)
- automatic acknowledgement ([SLSx.02 SLS acknowledgement](#) = Automatic)
- redundant SLS activation button connected to input ([SLSx.21 SLS2 input](#) = DI X113:2 & X114:2)
- single output connected ([SLSx.24 SLS2 output](#) = DO X114:7)
- positive limits: SLS 1200.0 rpm, trip limit 1320.0 rpm ([200.33 SLS2 limit positive](#) = 1200 rpm, [SLSx.23 SLS2 trip limit positive](#) = 1320 rpm).
- negative limits: SLS -900.0 rpm, trip limit -1020.0 rpm ([200.32 SLS2 limit negative](#) = -900 rpm, [SLSx.22 SLS2 trip limit negative](#) = -1020 rpm).
- See also section [Configuring mute times](#) on page 395.

Note: The difference between the SLS limit and the corresponding SLS trip limit must be at least 0.1 rpm.

Note: If you also use the SMS function, the SLS trip limits positive and negative must be below the speed defined by parameter [SMS trip limit positive](#) and above the speed defined by parameter [SMS trip limit negative](#), respectively.

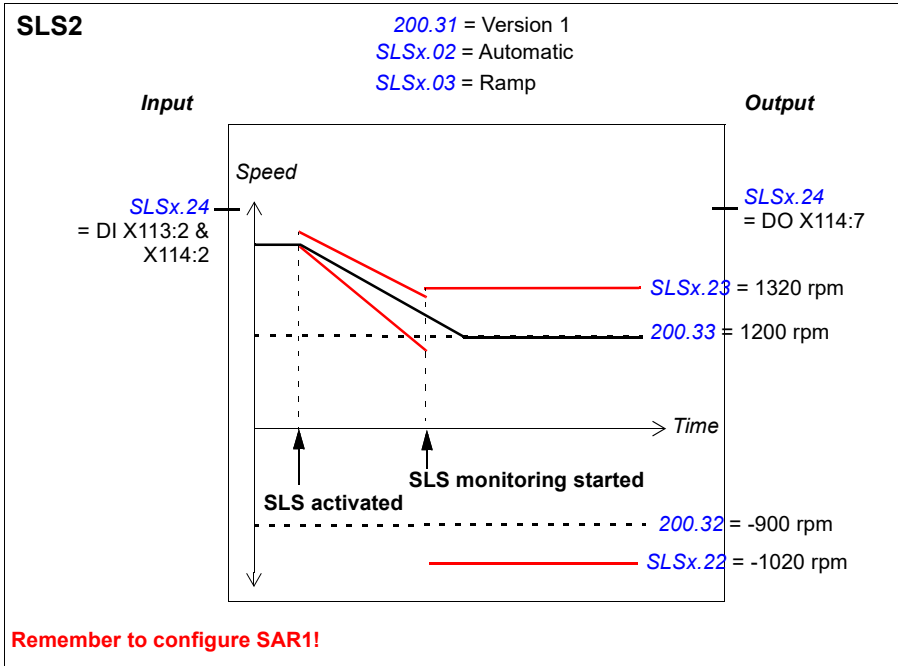

■ Related safety functions

The SLS1...4 functions use SAR1 parameters to monitor and/or define the deceleration ramp (SLS with ramp monitoring). See section [Configuring SAR](#) on page 363.

The FSO module activates the STO function if the motor speed hits a ramp monitoring limit during the deceleration ramp (SLS with ramp monitoring). See section [Configuring STO](#) on page 333.

The FSO module activates the SSE function if the motor speed hits a trip limit. See section [Configuring SSE](#) on page 353.

Configuring Variable SLS

This safety function requires that a safety PLC is connected to the FSO module via the PROFIsafe communication bus. For more information, see chapter [PROFIsafe](#) and section [Configuring the safety fieldbus communication](#) on page 320.

To configure the Variable SLS function, set the FSO parameters listed below to appropriate values using the Drive Composer pro PC tool. See parameter groups [Safety](#) on page 404 and [SLSx](#) on page 424.

The Variable SLS function uses the SLS4 limits of the FSO module. Depending on the application, set the negative and positive SLS and trip limits separately.

Note: If possible, reserve SLS4 function only for variable SLS use.

The FSO module scales the SLS4 trip limit so that the difference between the new limits does not become too small. For more information, see section [Defining the scaled SLS4 limit and SLS4 trip limits](#) on page 372.

Note: If SLS4 limits or trip limits are changed, it affects the Variable SLS limits and trip limits.

For more information on the Variable SLS function, see page 173.

■ How to configure Variable SLS with time monitoring

Example: The figure below shows an example of the Variable SLS function with time monitoring set-up:

- Variable SLS function activated
([200.61 SLS variable activity and version](#) = Version 1)
 - automatic acknowledgement ([SLSx.02 SLS acknowledgement](#) = Automatic)
 - time monitored deceleration ramp
([SLSx.03 SLS activation monitoring method](#) = Time)
 - deceleration and acceleration ramps according to drive parameters
 - SLS activation delay: 2000 ms ([SLSx.04 SLS time delay](#) = 2000 ms)
 - single output connected ([SLSx.51 Variable SLS output](#) = DO X114:7)
 - positive limits: SLS 1200.0 rpm, trip limit 1320.0 rpm
([200.53 SLS4 limit positive](#) = 1200 rpm,
[SLSx.43 SLS4 trip limit positive](#) = 1320 rpm).
 - negative limits: SLS -100.0 rpm, trip limit: -150.0 rpm
([FSOGEN.51 Zero speed without encoder](#) or when an encoder is used:
[FSOGEN.52 Zero speed with encoder](#)), not shown in the figure)
([200.52 SLS4 limit negative](#) = -100 rpm,
[SLSx.42 SLS4 trip limit negative](#) = -150 rpm).
 - See also section [Configuring mute times](#) on page 395.
-

Note: The difference between the SLS limit and the corresponding SLS trip limit must be at least 0.1 rpm.

These values are defined in the safety program:

- only positive limits are scaled: Positive_Scaling = 0, Negative_Scaling = 1
- scaling values from the safety PLC: 70%, 50%, 100%
(value set in Variable_SLS_limit = 7000, 5000, 10000).

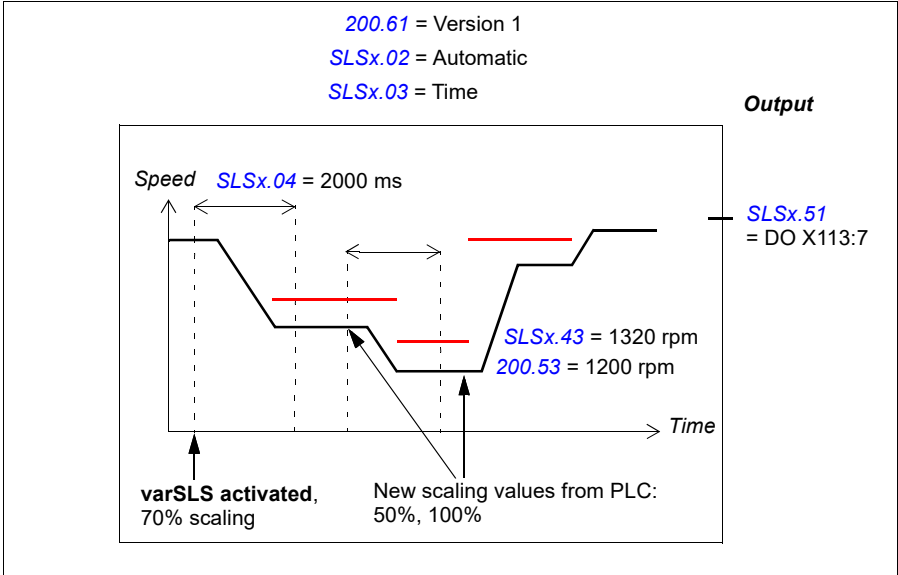

■ How to configure Variable SLS with ramp monitoring

Example: The figure below shows an example of the Variable SLS function with ramp monitoring set-up:

- Variable SLS function activated
([200.61 SLS variable activity and version](#) = Version 1)
- automatic acknowledgement ([SLSx.02 SLS acknowledgement](#) = Automatic)
- monitored deceleration ramp
([SLSx.03 SLS activation monitoring method](#) = Ramp)
- deceleration ramp and ramp monitoring limits according to SAR1 parameters, acceleration ramp according to drive parameters
- single output connected ([SLSx.51 Variable SLS output](#) = DO X114:7)
- positive limits: SLS 1200.0 rpm, trip limit 1320.0 rpm
([200.53 SLS4 limit positive](#) = 1200 rpm,
[SLSx.43 SLS4 trip limit positive](#) = 1320 rpm).
- negative limits: SLS -100.0 rpm, trip limit: -150.0 rpm
([FSOGEN.51 Zero speed without encoder](#) or when an encoder is used:
[FSOGEN.52 Zero speed with encoder](#)), not shown in the figure)
([200.52 SLS4 limit negative](#) = -100 rpm,
[SLSx.42 SLS4 trip limit negative](#) = -150 rpm).
- See also section [Configuring mute times](#) on page 395.

Note: The difference between the SLS limit and the corresponding SLS trip limit must be at least 0.1 rpm.

These values are defined in the safety program:

- only positive limits are scaled: Positive_Scaling = 0, Negative_Scaling = 1
- scaling values from the safety PLC: 70%, 50%, 100%
(value set in Variable_SLS_limit = 7000, 5000, 10000).

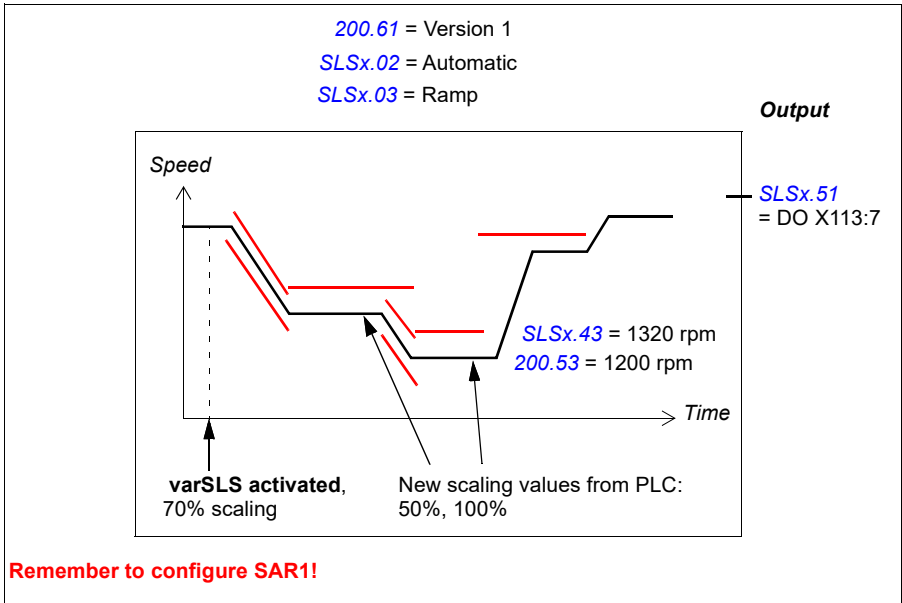

See also section *SLS reaction when modulation is lost during deceleration ramp, with ramp monitoring* on page 148.

■ Defining the scaled SLS4 limit and SLS4 trip limits

Because the same scaling percentage is used to scale both the original SLS4 limit and SLS4 trip limit, this affects the difference between new, scaled SLS4 limit and SLS4 trip limits. The FSO scales the SLS4 trip limit so that the difference between the new limits does not become too small.

The FSO module first scales the original SLS4 and SLS4 trip limits with the given percentage. If necessary, the new, scaled SLS4 trip limit is the adjusted according to these rules when safe speed estimate is used:

- If the difference between *original SLS4 and SLS4 trip limits* < 25 rpm: the difference between the scaled limits is the same as the original difference. See Example 1 below.
- If the difference between *original SLS4 and SLS4 trip limits* > 25 rpm: the difference between the limits is at least 25 rpm. See Example 2 below.
- Regardless of the original difference between the limits, the scaled SLS4 trip limit must always be at least the zero speed value (parameter [FSOGEN.51](#)).

If an encoder is used, the rules become:

- If the difference between *original SLS4 and SLS4 trip limits* < 5 rpm: the difference between the scaled limits is the same as the original difference.
 - If the difference between *original SLS4 and SLS4 trip limits* > 5 rpm: the difference between the limits is at least 5 rpm. See Example 3 below.
 - Regardless of the original difference between the limits, the scaled SLS4 trip limit must always be at least the zero speed value (parameter [FSOGEN.52](#)).
-

Example 1 (no encoder):

- Original SLS4 limit 100 rpm
- Original SLS4 trip limit 102 rpm
- Zero speed value 12 rpm

In this case, the difference between original SLS4 and SLS4 trip limits is smaller than 25 rpm. Trip limit is scaled to at least 2 rpm higher than the SLS4 limit. When the scaling value is 10% or less, trip limit is determined by the zero speed value.

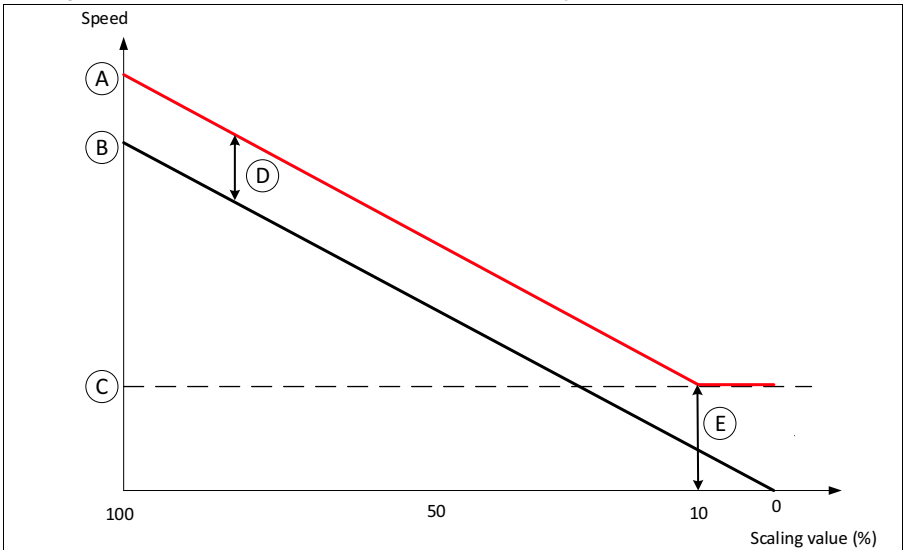

- A Scaled SLS4 trip limit
- B Scaled SLS4 limit
- C Zero speed value [FSOGEN.51](#)
- D The difference between scaled SLS4 limit and trip limit (2 rpm)
- E Minimum value for scaled SLS4 trip limit determined by the zero speed value (12 rpm)

Example 2 (no encoder):

- Original SLS4 limit 100 rpm
- Original SLS4 trip limit 150 rpm
- Zero speed value 12 rpm

In this case, the difference between original SLS4 and SLS4 trip limits is greater than 25 rpm. SLS4 limit and trip limit are scaled down normally from 100% to 50%. When the scaling value is 50%, the difference between the limits is 25 rpm and it stays

constant even if the scaling value is decreased further. Zero speed value is less than the 25 rpm and has no effect to the trip limit scaling.

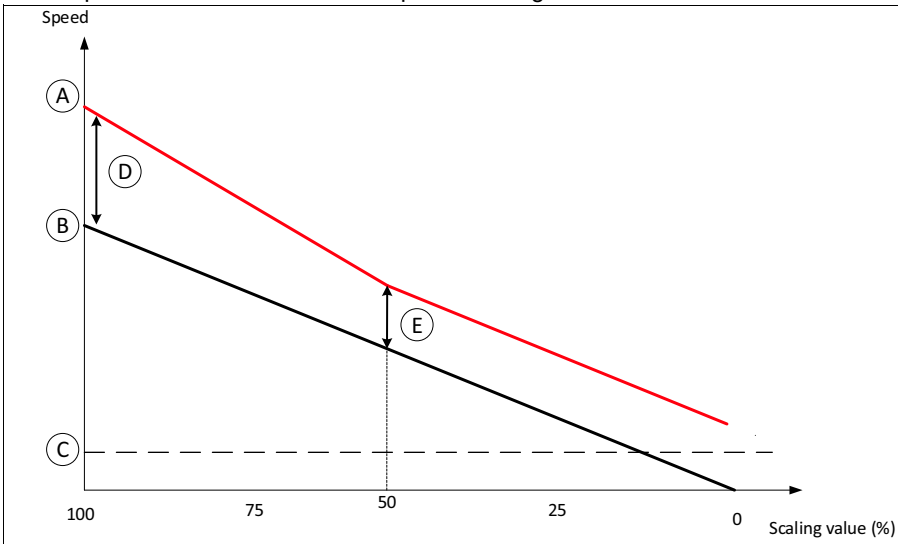

- A Scaled SLS4 trip limit
- B Scaled SLS4 limit
- C Zero speed value *FSOGEN.51*
- D The difference between SLS4 limits is 50 rpm when the scaling value is 100%
- E The difference between the scaled SLS4 limits is 25 rpm if the scaling value is 50% or less

Example 3 (with encoder):

- Original SLS4 limit 100 rpm
- Original SLS4 trip limit 110 rpm
- Zero speed value 3 rpm

In this example, the difference between original SLS4 and SLS4 trip limits is greater than 5 rpm. SLS4 limit and trip limit are scaled down normally from 100% to 50%. When the scaling value is 50%, the difference between the limits is 5 rpm and it stays

constant even if the scaling value is decreased further. Zero speed value is less than the 5 rpm and has no effect to the trip limit scaling.

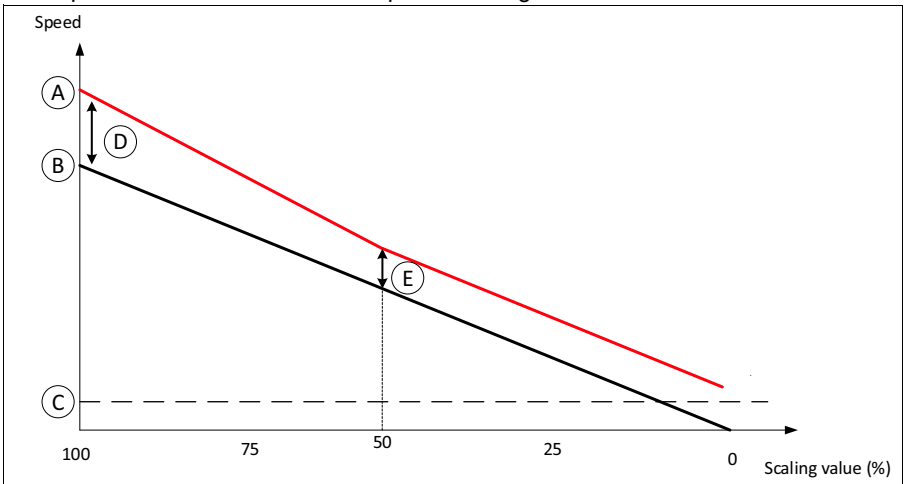

- A Scaled SLS4 trip limit
- B Scaled SLS4 limit
- C Zero speed value
- D The difference between SLS4 limits is 10 rpm when the scaling factor is 100%
- E The difference between the scaled SLS4 limits is 5 rpm if the scaling value is 50% or less

■ Related safety functions

The Variable SLS function uses SAR1 parameters to monitor and/or define the deceleration ramp (Variable SLS with ramp monitoring). See section [Configuring SAR](#) on page 363.

The FSO module activates the STO function if the motor speed hits a ramp monitoring limit during the deceleration ramp (Variable SLS with ramp monitoring). See section [Configuring STO](#) on page 333.

The FSO module activates the SSE function if the motor speed hits a trip limit. See section [Configuring SSE](#) on page 353.

Configuring SMS

To configure the SMS, set the FSO parameters listed below to appropriate values using the Drive Composer pro PC tool. See parameter groups [SMS](#) on page 432 and [Safety](#) on page 404.

There are two different versions of the SMS function. Select the required version with parameter [200.71 SMS activity and version](#).

For more information on the SMS function, see page 178.

■ How to configure SMS, version 1

Example: The figure below shows an example of the SMS, version 1 set-up:

- SMS function version 1 activated ([200.71 SMS activity and version](#) = Version 1)
- positive limit 1800.0 rpm ([SMS.14 SMS trip limit positive](#) = 1800 rpm)
- negative limit -1200.0 rpm ([SMS.13 SMS trip limit negative](#) = -1200 rpm)
- SSE function configured as immediate STO ([SSE.13 SSE function](#) = Immediate STO).
- See also section [Configuring mute times](#) on page 395.

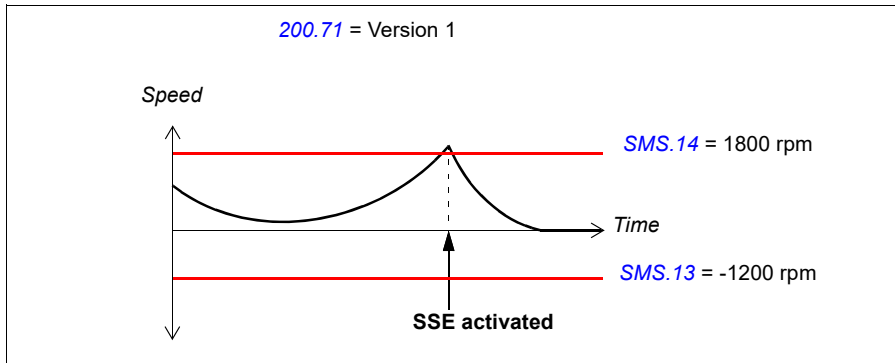

How to configure SMS, version 2

Example: The figure below shows an example of the SMS, version 2 set-up:

- SMS function version 2 activated (*200.71 SMS activity and version = Version 2*)
- SMS limit positive (*200.73 SMS limit positive = 1750*)
- SMS limit negative (*200.72 SMS limit negative = -1150*)
- SMS trip limit positive 1800.0 rpm (*SMS.14 SMS trip limit positive = 1800 rpm*)
- SMS trip limit negative -1200.0 rpm (*SMS.13 SMS trip limit negative = -1200 rpm*)
- SSE function configured as immediate STO (*SSE.13 SSE function = Immediate STO*).
- See also section *Configuring mute times* on page 395.

Note: If you also use an SLS function, the SMS positive and negative trip limits must be more than the speed defined by the corresponding SLS positive trip limit and less than the speed defined by the corresponding SLS negative trip limit, respectively.

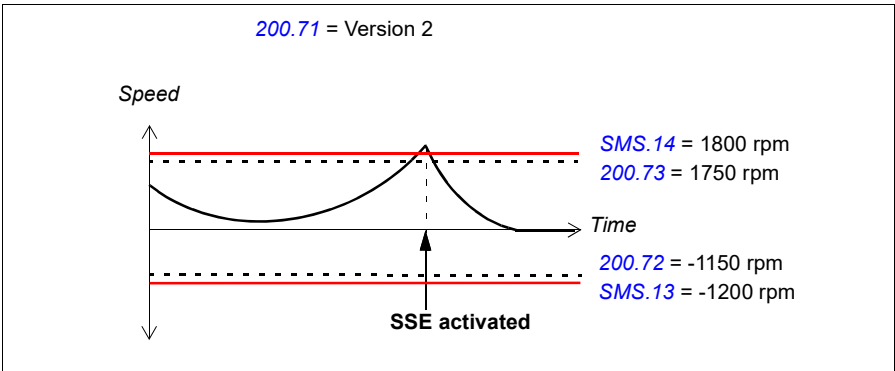

Related safety functions

The FSO module activates the SSE function if the motor speed hits an SMS trip limit. See section *Configuring SSE* on page 353.

Configuring POUS

How to configure POUS

To configure the POUS function, set the FSO parameters listed below to appropriate values using the Drive Composer pro PC tool. See parameter group [POUS](#) on page [417](#).

For more information on the POUS function, see page [181](#).

Example: The figure below shows an example of the POUS function set-up:

- POUS function activated (*POUS.01 POUS activity and version = Version 1*)
- automatic acknowledgement (*POUS.02 POUS acknowledgement = Automatic*)
- redundant POUS switch connected to inputs X113:1 and X114:1 (*POUS.11 POUS input = DI X113:1 & X114:1*)
- delay for POUS complete indication: 0 (*POUS.13 POUS delay for completion = 0 ms*)
- POUS completed output (for example, an indication lamp) connected to single output: X114:9 (*POUS.22 POUS completed output = DO X114:9*).

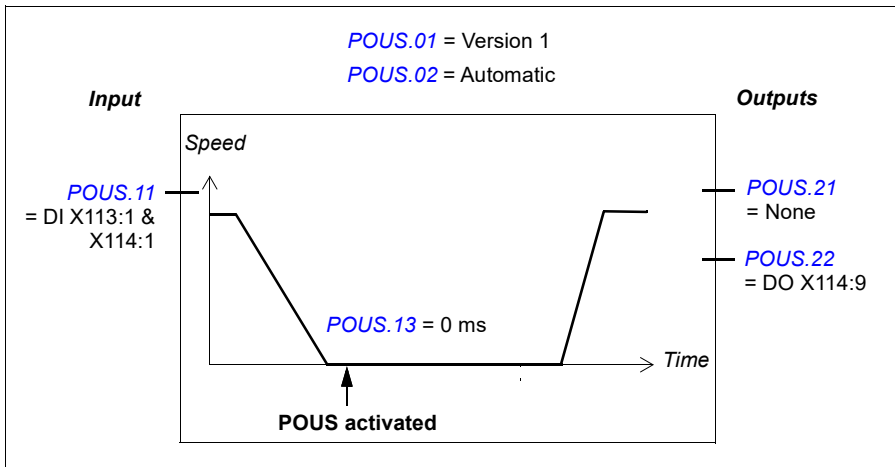

How to configure SLS function behavior when drive modulation is lost

When it is critical for the process that the drive must be able to indicate safely if the drive modulation is lost during SLS deceleration, user must configure this behavior separately for the SLS function. Once the configuration for the modoff behavior is made, it is the same for SLS 1...SLS 4 functions and for variable SLS function.

To configure SLS functions into use (SLS1...SLS4 or variable SLS), see chapters [Configuring SLS](#) on page 364 and [Configuring Variable SLS](#) on page 368. The following parametrization is relevant for a situation where drive modulation is lost during SLS deceleration ramp and SLS function is activated when motor speed is higher than SLS limit speed.

For more information on the modoff reaction related to SLS function, see [SLS reaction when modulation is lost during deceleration ramp, with ramp monitoring](#) on page 148 and [SLS reaction when modulation is lost during deceleration ramp, with time monitoring](#) on page 158.

■ How to configure SLSn with time monitoring if drive modulation is lost during SLS deceleration ramp

Example 1: The figure below shows an example of the modoff situation with SLS function with time monitoring when "Modoff delay time" (parameter [SLSx.05](#)) is selected:

- Basic parametrization of the SLS function made according to chapter [Configuring SLS](#) on page 364.
- Modoff delay time monitoring is active when drive modulation is lost ([SLSx.05 SLS ramp modoff reaction](#) = Modoff delay time)
- Modoff delay time ([SLSx.06 SLS ramp modoff delay time](#) = 200 ms)

Relevant parameters for this configuration:

- Deceleration time (drive parameter 23.13 Deceleration time 1)
 - SLS activation delay: 2000 ms ([SLSx.04 SLS time delay](#) = 2000 ms)
 - [STO.14 Time to zero speed with STO and modoff](#): 2500 ms.
-

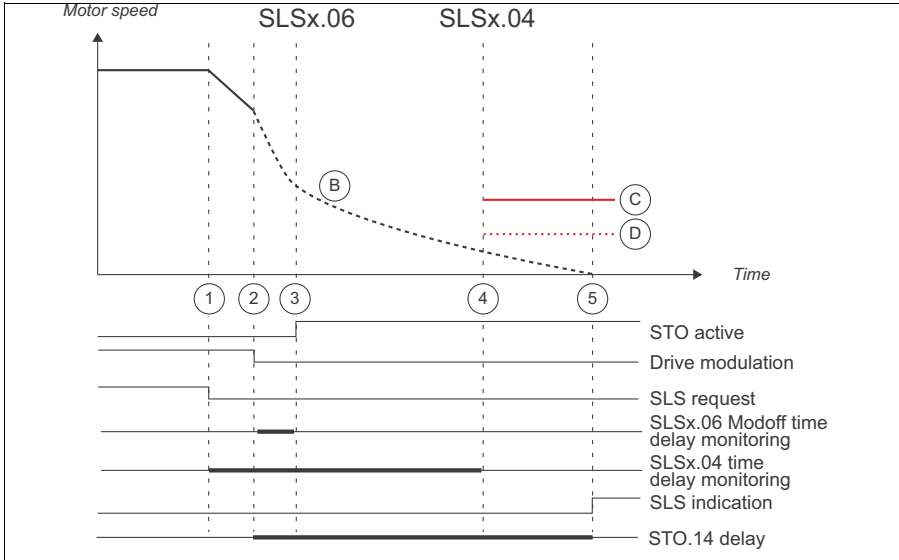

1. SLS request is activated (*SLSx.11 SLS1 input A* = DI X113:2 & X114:2). SLS time delay monitoring is started (*SLSx.04 SLS time delay* = 2000 ms). Deceleration to SLS limit speed is started (23.13 Deceleration time 1).
2. Modulation is lost. Motor starts to coast to a stop. SLS time monitoring limit is kept active also when modulation is lost (*SLSx.04 SLS time delay* = 2000 ms). Modoff delay time starts to run (*SLSx.06 SLS ramp modoff delay time* = 200 ms).
3. Modulation of the drive has not returned before the SLS ramp modoff delay time has elapsed (*SLSx.06 SLS ramp modoff delay time* = 200 ms). FSO activates SSE function (*SSE.13 SSE function*) as the modulation is lost. SSE function triggers STO function regardless of the configuration of the SSE function. STO indication goes on (*STO.21 STO output* = DO X113:7).
4. SLS time monitoring limit (*SLSx.04 SLS time delay* = 2000 ms).
5. *STO.14* delay starts when drive modulation is lost. If modulation does not return, SLS indication goes on after *STO.14* delay has elapsed.

Example 2: The figure below shows an example of the modoff situation with SLS function with time monitoring when "Monitoring active" (parameter *SLSx.05*) is selected:

- Basic parametrization of the SLS function made according to chapter *Configuring SLS* on page 364.
- Monitoring active when drive modulation is lost (*SLSx.05 SLS ramp modoff reaction* = Monitoring active)

Relevant parameters for this configuration:

- Deceleration time (drive parameter 23.13 Deceleration time 1)
- SLS activation delay: 2000 ms (*SLSx.04 SLS time delay* = 2000 ms)
- *STO.14 Time to zero speed with STO and modoff*: 2500 ms.

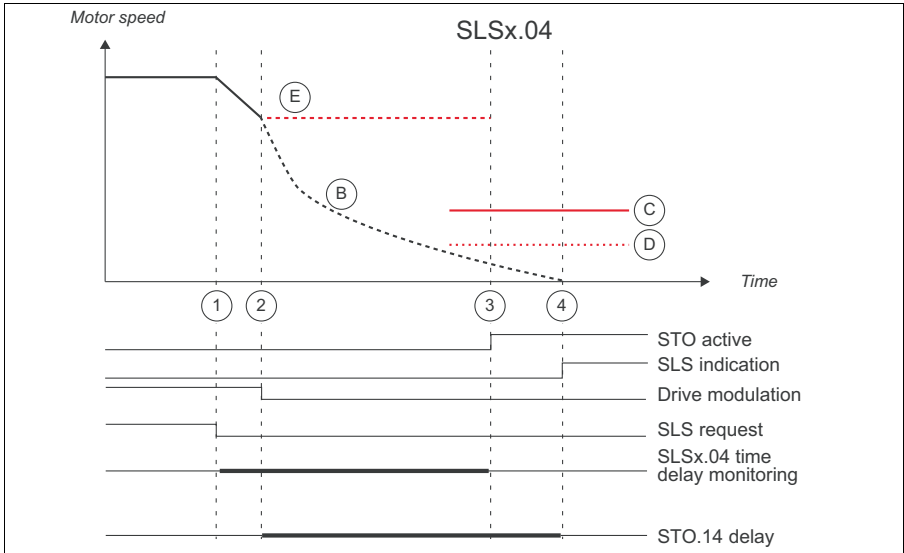

1. SLS request is activated (*SLSx.11 SLS1 input A* = DI X113:2 & X114:2). SLS time delay monitoring is started (*SLSx.04 SLS time delay* = 2000 ms). Deceleration to SLS limit speed is started (drive parameter 23.13 Deceleration time 1).
2. Modulation is lost. Motor starts to coast to a stop. FSO stores last valid safe speed estimation value. SLS time monitoring limit is kept active also when modulation is lost (*SLSx.04 SLS time delay* = 2000 ms).
3. Last valid speed estimation value is higher than SLS trip limit speed when SLS time monitoring limit has elapsed (*SLSx.04 SLS time delay* = 2000 ms). STO indication goes on (*STO.21 STO output* = DO X113:7); see chapter [How to configure STO](#) on page 333.
4. *STO.14* delay starts when drive modulation is lost. If modulation does not return, SLS indication goes on after *STO.14* delay has elapsed.

When drive modulation is lost, last valid speed estimate is stored to FSO module until modulation comes back or monitoring limit is reached. Time monitoring is kept active also when modulation is lost during SLS deceleration ramp. The time monitoring begins when SLS is requested. A time monitoring hit due to lost modulation is generated when SLS time delay has elapsed. SLS hit is indicated and STO is activated. Drive restart is not possible until *STO.14* delay has elapsed.

Example 3: The figure below shows an example of the SLS function with time monitoring when "Monitoring active and modoff delay time" (parameter *SLSx.05*) is selected:

- Basic parametrization of the SLS function made according to chapter *Configuring SLS* on page 364.
- Monitoring and modoff delay time are active when drive modulation is lost (*SLSx.05 SLS ramp modoff reaction* = Monitoring active and modoff delay time)
- Modoff delay time (*SLSx.06 SLS ramp modoff delay time* = 300 ms)

Relevant parameters for this configuration:

- Deceleration time (drive parameter 23.13 Deceleration time 1)
- SLS activation delay: 2000 ms (*SLSx.04 SLS time delay* = 2000 ms)
- *STO.14 Time to zero speed with STO and modoff*: 2500 ms.

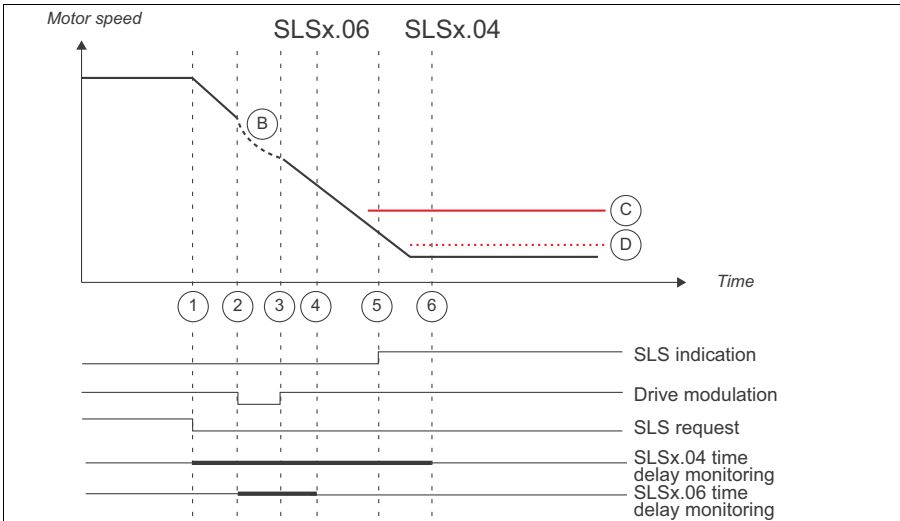

1. SLS request is activated (*SLSx.11 SLS1 input A* = DI X113:2 & X114:2). SLS time delay monitoring is started (*SLSx.04 SLS time delay* = 2000 ms). Deceleration to SLS limit speed is started (23.13 Deceleration time 1).
2. Modulation is lost. Motor starts to coast to a stop. SLS time monitoring limit is kept active also when modulation is lost (*SLSx.04 SLS time delay* = 2000 ms). Modoff delay time starts to run (*SLSx.06 SLS ramp modoff delay time* = 300 ms).
3. Modulation of the drive returns before the SLS ramp modoff delay time has elapsed (*SLSx.06 SLS ramp modoff delay time* = 300 ms). Drive continues to decelerate according to drive parameter in step 2.
4. SLS ramp modoff delay time limit (*SLSx.06 SLS ramp modoff delay time* = 300 ms).
5. The speed of the drive reaches the SLS speed limit (*200.23 SLS1 limit positive* = 1200 rpm). SLS monitoring is activated and SLS indication goes on (*SLSx.15 SLS1 output A* = DO X114:7).
6. The *SLSx.04* time monitoring limit. SLS indication is activated at the latest.

Time monitoring is kept active also when modulation is lost during SLS deceleration ramp and *SLSx.06 SLS ramp modoff delay time* is set shorter than *SLSx.04 SLS time delay*. FSO indicates SLS hit and STO is activated when *SLSx.06* has elapsed. Drive restart is possible until *SLSx.06* has elapsed.

Example 4: The figure below shows an example of the SLS function with time monitoring when "Monitoring and modoff delay time disabled" (parameter *SLSx.05*) is selected:

- Basic parametrization of the SLS function made according to chapter *Configuring SLS* on page 364.
- Monitoring and modoff delay time are disabled when drive modulation is lost (*SLSx.05 SLS ramp modoff reaction* = Monitoring and modoff delay time disabled)

Relevant parameters for this configuration:

- Deceleration time (drive parameter 23.13 Deceleration time 1)
 - SLS activation delay: 2000 ms (*SLSx.04 SLS time delay* = 2000 ms)
 - *STO.14 Time to zero speed with STO and modoff*: 2500 ms.
-

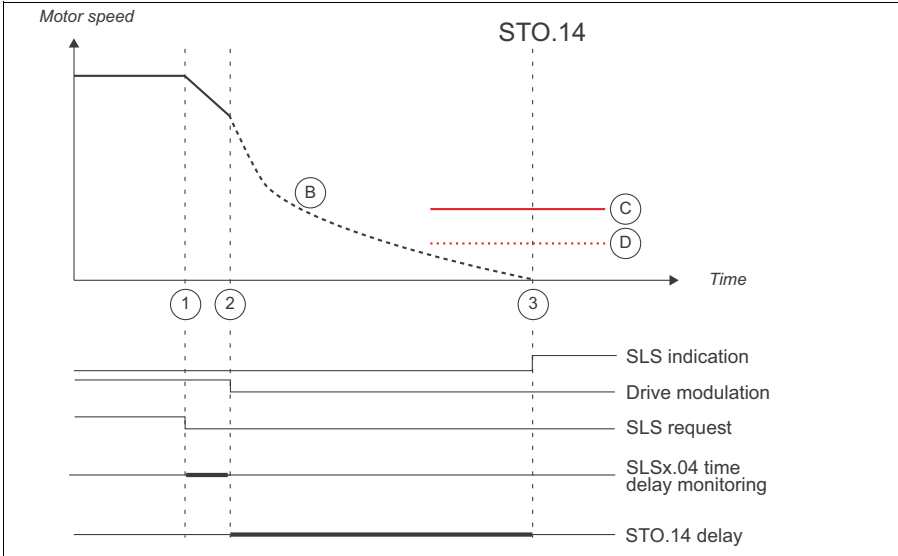

1. SLS request is activated (*SLSx.11 SLS1 input A* = DI X113:2 & X114:2). SLS time delay monitoring is started (*SLSx.04 SLS time delay* = 2000 ms). Deceleration to SLS limit speed is started (23.13 Deceleration time 1).
2. Modulation is lost. Motor starts to coast to a stop. SLS time monitoring limit is disabled when modulation is lost (*SLSx.04 SLS time delay* = 2000 ms). Time to zero speed with STO and modoff starts to run (*STO.14 Time to zero speed with STO and modoff* = 2500 ms).
3. Modulation of the drive does not return. After *STO.14* has elapsed, SLS indication goes on (*SLSx.15 SLS1 output A* = DO X114:7).

The time monitoring of the SLS function is disabled when modulation of the drive is lost during SLS deceleration ramp. When the drive stops modulation, FSO disables the time monitoring of the SLS function and starts to wait that the motor will coast to zero speed (*STO.14 Time to zero speed with STO and modoff*). When *STO.14* has elapsed, SLS indication goes on. *STO.14* delay should be parametrized so that when this time has elapsed, the motor speed is 0.

■ **How to configure SLSn with ramp monitoring if drive modulation is lost during SLS deceleration ramp**

Example 1: The figure below shows an example of the modoff situation with SLS function with ramp monitoring when "Modoff delay time" (parameter *SLSx.05*) is selected:

- Basic parametrization of the SLS function made according to chapter *Configuring SLS* on page 364.
- Modoff delay time monitoring is active when drive modulation is lost (*SLSx.05 SLS ramp modoff reaction* = Modoff delay time)
- Modoff delay time (*SLSx.06 SLS ramp modoff delay time* = 200 ms)

Relevant parameters for this configuration:

- Scaling speed: 1500 rpm (*200.202 SAR speed scaling* = 1500 rpm)
- Deceleration time and ramp monitoring according to SAR1 parameters
 - ramp time from Scaling speed to zero: 1000 ms (*200.112 SAR1 ramp time to zero* = 1000 ms)
 - initial range for monitoring: 100 ms (*SARx.02 SAR initial allowed range* = 100 ms)
 - minimum allowed ramp time: 500 ms (*SARx.21 SAR1 min ramp time to zero* = 500 ms)
 - maximum allowed ramp time: 1000 ms (*SARx.22 SAR1 max ramp time to zero* = 1500 ms).
- *STO.14 Time to zero speed with STO and modoff*: 2500 ms.

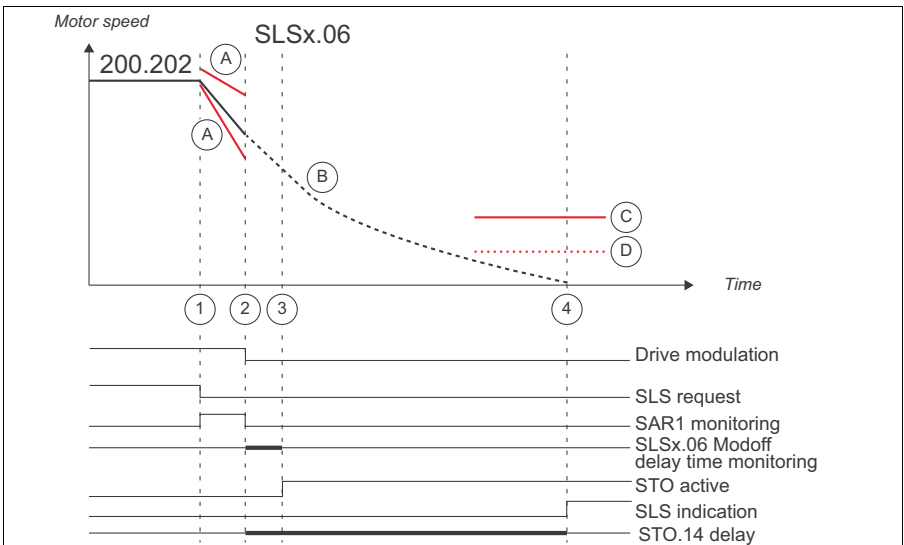

1. SLS request is activated (*SLSx.11 SLS1 input A* = DI X113:2 & X114:2). SLS ramp monitoring is activated (SAR1). Parameter *200.202 SAR speed scaling* (= 1500 rpm) is used as a reference point in ramp time calculations. Deceleration towards the SLS limit speed is started according to SAR1 parameters:
 - ramp time from Scaling speed to zero: 1000 ms (*200.112 SAR1 ramp time to zero* = 1000 ms)
 - initial range for monitoring: 100 ms (*SARx.02 SAR initial allowed range* = 100 ms)
 - minimum allowed ramp time: 500 ms (*SARx.21 SAR1 min ramp time to zero* = 500 ms)
 - maximum allowed ramp time: 1000 ms (*SARx.22 SAR1 max ramp time to zero* = 1500 ms).
2. Modulation is lost. Motor starts to coast to a stop. SLS ramp monitoring is disabled. Modoff delay time starts to run (*SLSx.06 SLS ramp modoff delay time* = 200 ms).
3. Modulation of the drive has not returned before the SLS ramp modoff delay time has elapsed (*SLSx.06 SLS ramp modoff delay time* = 200 ms). FSO activates STO function. STO indication goes on (*STO.21 STO output* = DO X113:7).
4. *STO.14* delay starts when drive modulation is lost. If modulation does not return, SLS indication goes on after *STO.14* delay has elapsed.

When drive modulation is lost, last valid speed estimate is shown to FSO module until modulation comes back or monitoring limit is reached. SAR1 monitoring is disabled when modulation is lost during SLS deceleration ramp.

Example 2: The figure below shows an example of the modoff situation with SLS function with ramp monitoring when "Monitoring active" (parameter *SLSx.05*) is selected:

- Basic parametrization of the SLS function made according to chapter *Configuring SLS* on page 364.
 - Monitoring active when drive modulation is lost (*SLSx.05 SLS ramp modoff reaction* = Monitoring active)
-

Relevant parameters for this configuration:

- Scaling speed: 1500 rpm (*200.202 SAR speed scaling* = 1500 rpm)
- Deceleration time and ramp monitoring according to SAR1 parameters
 - ramp time from Scaling speed to zero: 1000 ms (*200.112 SAR1 ramp time to zero* = 1000 ms)
 - initial range for monitoring: 100 ms (*SARx.02 SAR initial allowed range* = 100 ms)
 - minimum allowed ramp time: 500 ms (*SARx.21 SAR1 min ramp time to zero* = 500 ms)
 - maximum allowed ramp time: 1000 ms (*SARx.22 SAR1 max ramp time to zero* = 1500 ms).
- *STO.14 Time to zero speed with STO and modoff*: 2500 ms.

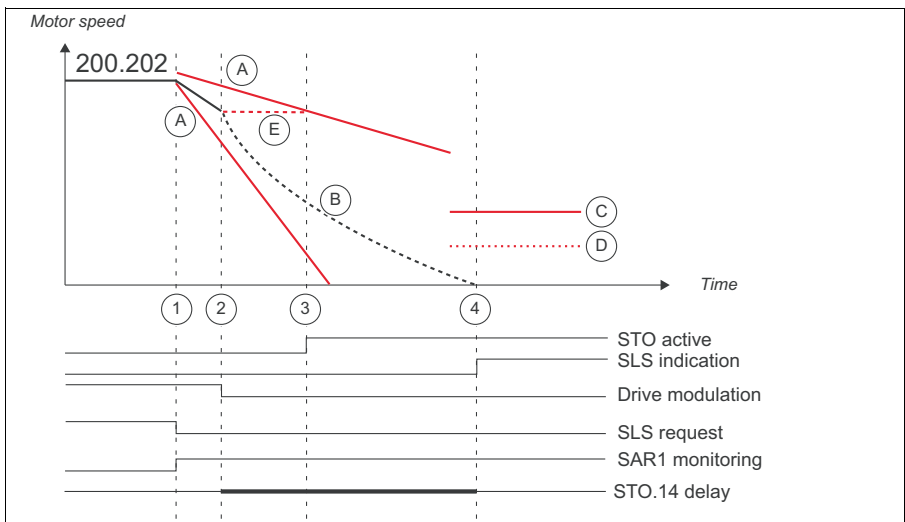

1. SLS request is activated (*SLSx.11 SLS1 input A* = DI X113:2 & X114:2). SLS ramp monitoring is activated (SAR1). Parameter *200.202 SAR speed scaling* (= 1500 rpm) is used as a reference point in ramp time calculations. Deceleration towards the SLS limit speed is started according to SAR1 parameters.
 - ramp time from Scaling speed to zero: 1000 ms (*200.112 SAR1 ramp time to zero* = 1000 ms)
 - initial range for monitoring: 100 ms (*SARx.02 SAR initial allowed range* = 100 ms)
 - minimum allowed ramp time: 500 ms (*SARx.21 SAR1 min ramp time to zero* = 500 ms)
 - maximum allowed ramp time: 1000 ms (*SARx.22 SAR1 max ramp time to zero* = 1500 ms).

2. Modulation is lost. Motor starts to coast to a stop. FSO stores last valid safe speed estimation value. SLS ramp monitoring limit (SAR1) is kept active also when modulation is lost.
3. Modulation of the drive has not returned. If *SLSx.05* is set to Monitoring active, SAR1 monitoring limit hit is generated based on the last valid speed estimate of FSO.
4. *STO.14* delay starts when drive modulation is lost. If modulation does not return, SLS indication goes on after *STO.14* delay has elapsed.

When drive modulation is lost, last valid speed estimate is stored to FSO module until modulation comes back or monitoring limit is reached. Ramp monitoring is kept active also when modulation is lost during SLS deceleration ramp. The ramp monitoring is activated when SLS is requested.

Note: It is also possible to use fixed delay time until tripping fault without time/ramp monitoring by setting *SLSx.05* to *Modoff delay time* and by setting a suitable delay until tripping fault with *SLSx.06*. With value 0, the tripping fault is generated immediately.

Note: *SLSx.05* and *SLSx.06* are used only with speed estimate and only with SLS1...SLS4 and Variable SLS functions in a situation where drive modulation is lost during deceleration to SLS speed.

Configuring SSM

To configure the SSM function, set the FSO parameters listed below to appropriate values using the Drive Composer pro PC tool. See parameter group [SSMx](#) on page [437](#).

You can use the SSM function either with a safety encoder or with a safe speed estimate. For more information on the SSM function, see page [183](#). If you use an encoder, you must configure the encoder interface first (see section [Configuring the safety encoder interface](#) on page [315](#)).

Note: Depending on the application, set the negative and positive SSM limits separately.

■ How to configure SSM

Example: The figure below shows an example of an SSM1 set-up. Only the positive SSM1 limit is configured.

- SSM1 function activated (*SSMx.01 SSM1 activity and version = Version 1*)
- redundant SSM activation button connected to input (*SSMx.11 SSM1 input = DI X113:2 & X114:2*)
- single output connected (*SSMx.14 SSM1 output = DO X114:7*)
- SSM1 positive limit 1800.0 rpm (*SSMx.13 SSM1 limit positive = 1800 rpm*)
- SSM1 negative limit 0 rpm (*SSMx.12 SSM1 limit negative = 0 rpm*).
- **When an encoder is not used:** Time to zero speed: 1500 ms. This is the estimated time in which the motor coasts to a stop from the maximum speed (*STO.14 Time to zero speed with STO and modoff = 1500 ms*, not shown in the figure).

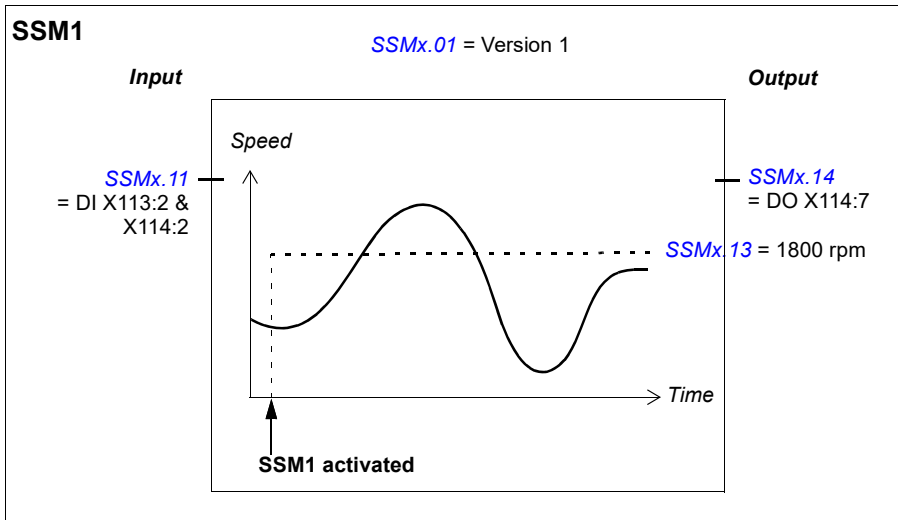

Configuring SDI

To configure the SDI function, set the FSO parameters listed below to appropriate values using the Drive Composer pro PC tool. See parameter group [SDI](#) on page [433](#).

This safety function requires that an encoder is used. Configure the encoder interface first (see section [Configuring the safety encoder interface](#) on page [315](#)).

For more information on the SDI function, see page [187](#).

■ How to configure SDI with time monitoring

Example: The figure below shows an example of an SDI positive function with time monitoring set-up:

- Version 1 of SDI functions activated (*SDI.01 SDI version = Version 1*)
- SDI positive function activated (*SDI.02 SDI positive activity = Enabled*)
- time monitored ramp (*SDI.10 SDI activation monitoring method = Time*)
- deceleration ramp according to drive parameters (always with time monitoring)
- SDI activation delay 2000 ms (*SDI.12 SDI delay = 2000 ms*)
- SDI tolerance into the forbidden direction 2 degrees (*SDI.14 SDI tolerance limit degree = 2 deg*)
- automatic acknowledgement (*SDI.13 SDI acknowledgement = Automatic*)
- redundant activation button connected to input (*SDI.21 SDI positive input A = DI X113:2 & X114:2*)
- single output connected (*SDI.23 SDI positive output A = DO X114:7*).

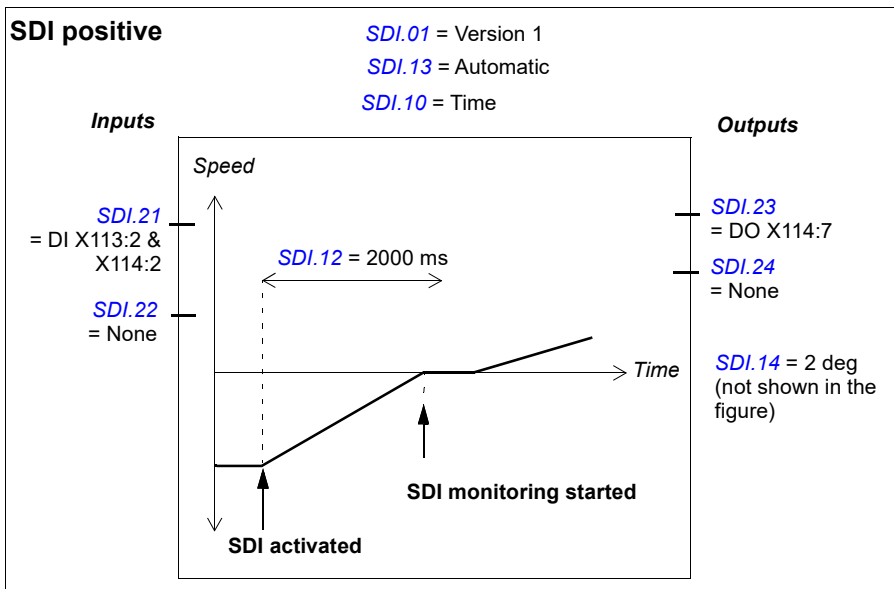

■ How to configure SDI with ramp monitoring

Example: The figure below shows an example of an SDI positive function with ramp monitoring set-up:

- Version 1 of SDI functions activated (*SDI.01 SDI version = Version 1*)
- SDI positive function activated (*SDI.02 SDI positive activity = Enabled*)
- monitored deceleration ramp (*SDI.10 SDI activation monitoring method = Ramp*)
- deceleration ramp and monitoring limits according SAR1 parameters (see section *Configuring SAR* on page 363)
- SDI tolerance into the forbidden direction 2 degrees (*SDI.14 SDI tolerance limit degree = 2 deg*)
- automatic acknowledgement (*SDI.13 SDI acknowledgement = Automatic*)
- redundant activation button connected to input (*SDI.21 SDI positive input A = DI X113:2 & X114:2*)
- single output connected (*SDI.23 SDI positive output A = DO X114:7*).

SDI positive

SDI.01 = Version 1

SDI.13 = Automatic

SDI.10 = Ramp

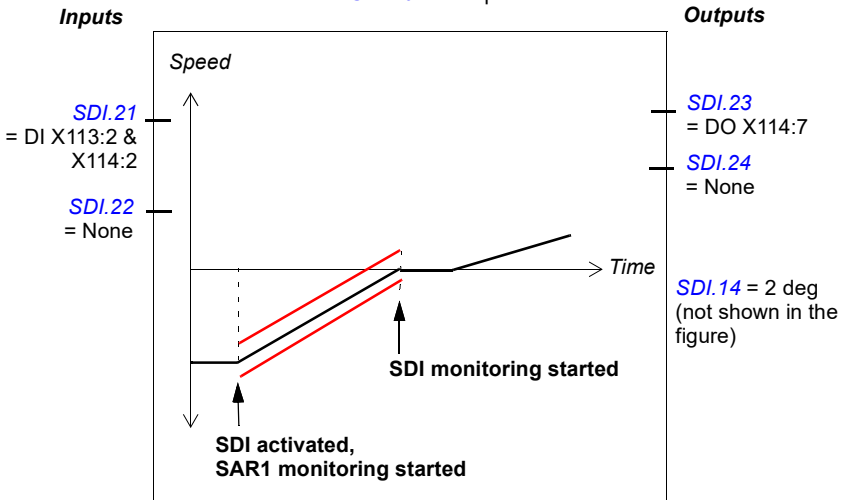

Remember to configure SAR1!

■ **Related safety functions**

The SDI functions use SAR1 parameters to monitor and/or define the deceleration ramp (SDI with ramp monitoring). See section [Configuring SAR](#) on page 363.

The FSO module activates the STO function if the motor speed hits a ramp monitoring limit during the deceleration ramp (SDI with ramp monitoring). See section [Configuring STO](#) on page 333.

The FSO module activates the SSE function if the motor rotation reaches the SDI tolerance limit degree. See section [Configuring SSE](#) on page 353.

Configuring mute times



WARNING! The mute time increases the response time of the safety system. This must be considered in the design of the safety system.

To minimize the effects of small transient variations in the speed measurement data, you can fine-tune the operation of the safety functions with mute time parameters. For the description of this feature, see [Mute time feature](#) on page 65.

■ How to determine values for mute time parameters

The suitable values for mute times can be determined by monitoring FSO speed signals ([200.01 FSO speed ch1](#), [200.02 FSO speed ch2](#)) with the Drive Composer pro tool. If possible, all transient situations within the whole speed range of the application should be monitored. Based on the results, the mute times should be set as short as possible. After the mute time parameters have been correctly set, safety functions can be validated. You can check the motor speed for motor control from the

following parameters: 1.1, 1.2, and 90.1. See drive firmware manual for more information.

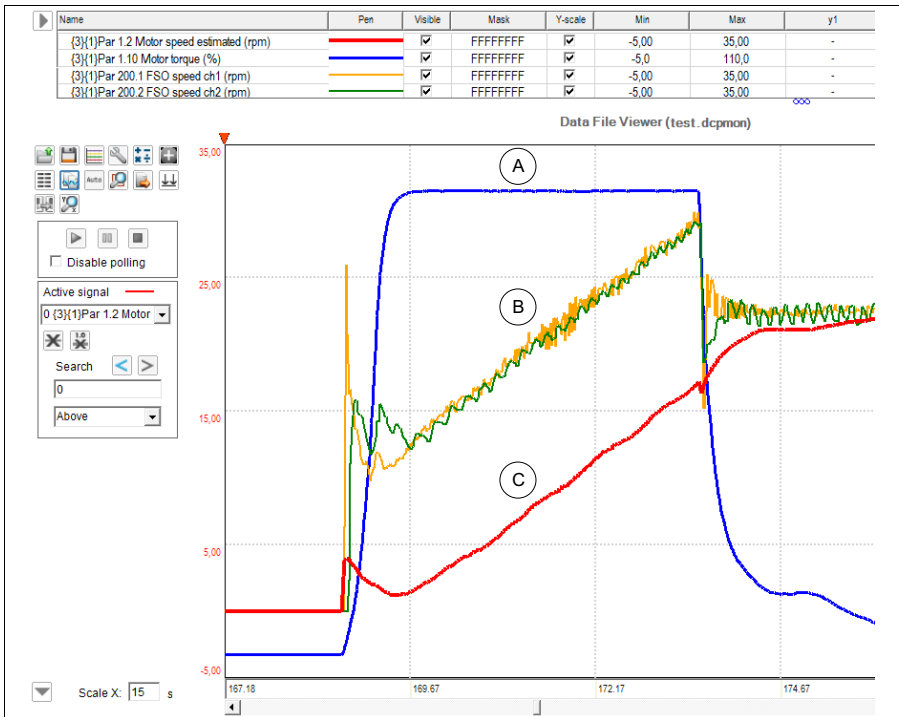

- A Motor torque
- B FSO speed signals
- C Motor speed estimate of the drive

■ How to configure limit hit situations

Example 1: SMS trip limit hit

This example covers trip limit situations of SMS function with synchronous machines. This example is valid when SMS-specific mute time is disabled (parameter [FSOGEN.39](#)) or if encoder is used.

- parameter [FSOGEN.39 Enable SMS mute time](#) = Disabled
- parameter [FSOGEN.31 Transient mute time](#) = 100 ms.

Note: When a synchronous machine is started, there is a possibility of short (< 100 ms) error spikes in safe speed estimate which can cause an unnecessary trip if the mute time is set too short. If the motor is rotated only in positive direction and

negative SMS trip limit is set close to zero speed, there is an increased possibility that the error spike could cause an unnecessary trip.

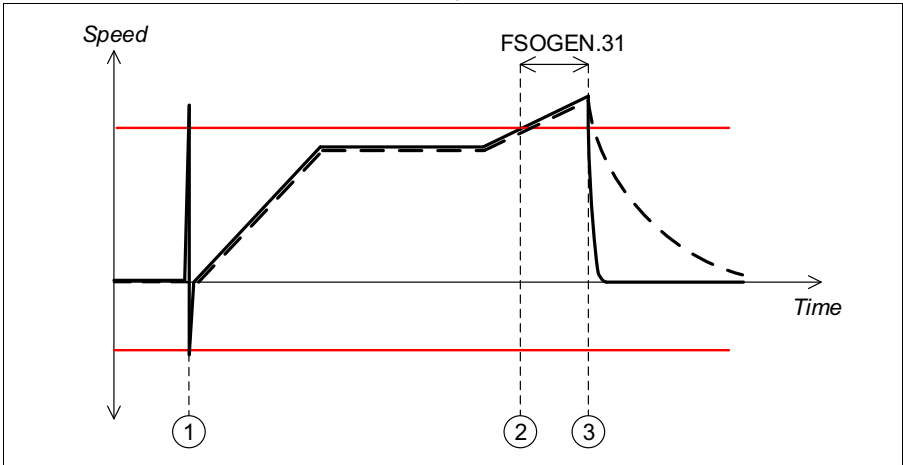

- - - Actual speed

— Safe speed estimate

— SMS trip limits

- 1 Error spike caused by the starting of the synchronous motor, spike duration 50 ms. [FSOGEN.31](#) is set longer than the error spike and the SSE is not activated.
- 2 Safe speed estimate exceeds the SMS trip limit
- 3 [FSOGEN.31 Transient mute time](#) has elapsed. SSE is activated.

This example also applies to:

- trip limit hits in the SLS1...4 and Variable SLS functions when the SLSx mute times are disabled with parameter [FSOGEN.38](#)

all trip limit hit situations regardless of parameters [FSOGEN.38](#) and [FSOGEN.39](#) if encoder is used.

Example 2: SLS safe speed estimate trip limit hit situation

Note: This example is for more complex systems which cannot be properly configured with general transient mute time.

This example covers safe speed estimate trip limit situations with acceleration of an induction motor. It is possible that safe speed estimate goes above the SLS trip limit for limited time when an induction machine is accelerated with high load inertia. In

this example, SLS1 function is used. Function-specific mute time is set long enough to prevent the limit hit during acceleration.

- parameter *FSOGEN.38 Enable SLSx mute times* = Enabled
- parameter *SLSx.17 Mute time for SLS1* = 1200 ms (function-specific)

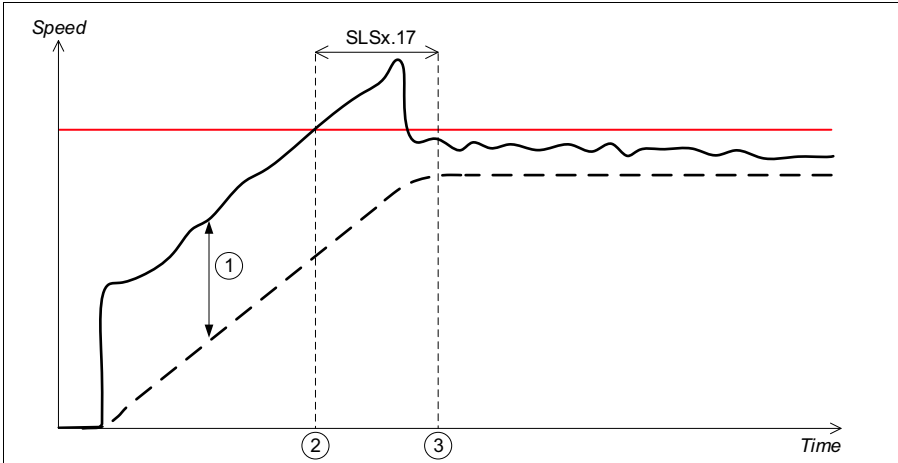

--- Actual speed

— Safe speed estimate

— SLS1 trip limit positive SLSx.14

- 1 Amount of slip in safe speed estimate during acceleration
- 2 Safe speed estimate exceeds the SLS trip limit
- 3 Safe speed estimate returns below SLS trip limit before the mute time for SLS1 has elapsed. SSE is not activated and drive continues normal operation.

This example also applies to:

- Trip limit hits in the SLS2...4 and Variable SLS functions when the SLSx mute times are enabled with parameter *FSOGEN.38 Enable SLSx mute times*
- Trip limit hit in the SMS function when the SMS mute time (*SMS.17*) is enabled with parameter *FSOGEN.39 Enable SMS mute time*.

■ **How to configure mute time for zero speed detection**

Example 1: Zero speed limit is reached with the SS1 function (or SSE with emergency ramp), the SBC is not used.

- **With an encoder:** parameter *FSOGEN.32 Zero speed delay time* = 20 ms
- **Without an encoder:** parameter *FSOGEN.31 Transient mute time* = 20 ms.

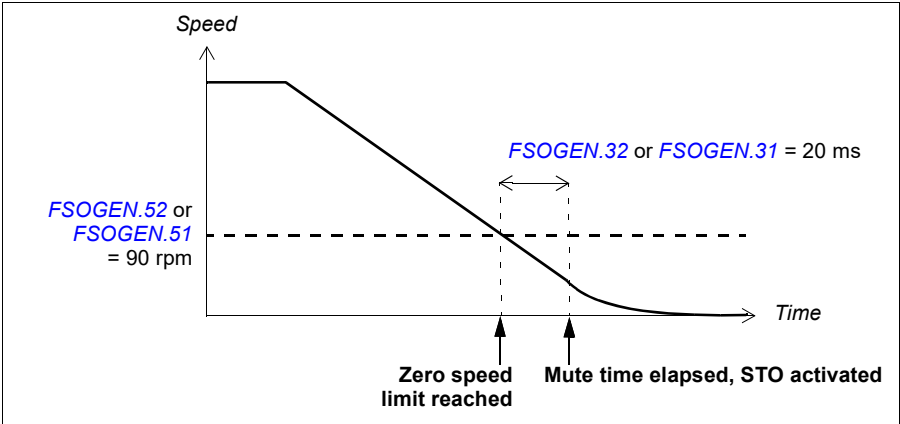

Example 2: Zero speed limit is reached with the SS1 function (or SSE with emergency ramp), a negative SBC delay (parameter *SBC.12 STO SBC delay*) is configured in the STO function:

- **With an encoder:** parameter *FSOGEN.32 Zero speed delay time* = 20 ms
- **Without an encoder:** parameter *FSOGEN.31 Transient mute time* = 20 ms.

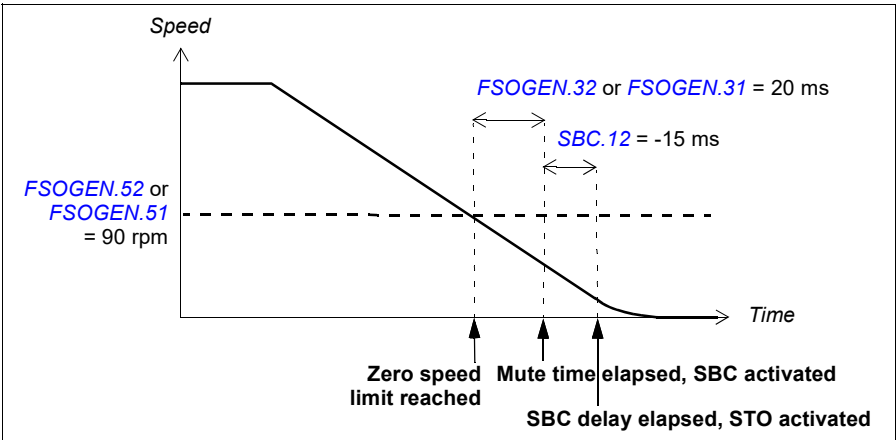

Note: If the SBC delay (parameter *SBC.12 STO SBC delay*) is positive or zero (0 ms), the SBC and STO functions are activated at the same time.

■ **How to configure mute time for SBC speed limit detection**

Example 1: SBC speed limit (parameter *SBC.15*) is reached with the SS1 function (or SSE with emergency ramp), a negative SBC delay (parameter *SBC.12* *STO SBC delay*) is configured with the SS1 function:

- **With an encoder:** parameter *FSOGEN.32 Zero speed delay time* = 20 ms
- **Without an encoder:** parameter *FSOGEN.31 Transient mute time* = 20 ms.

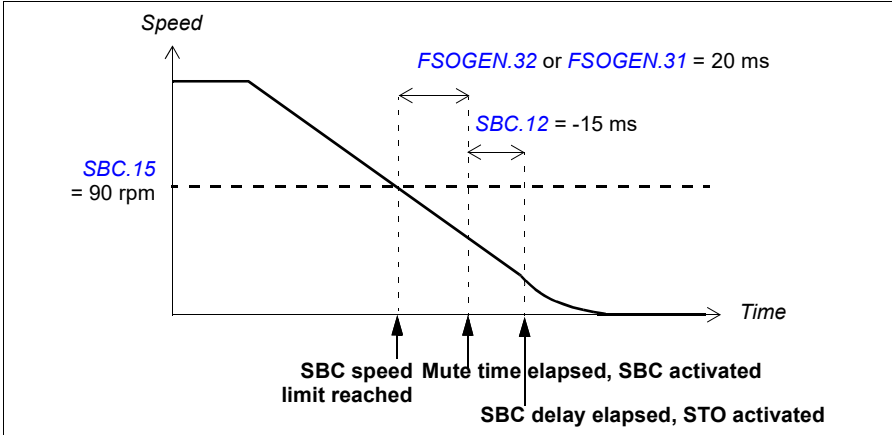

Note: If the SBC delay (parameter *SBC.12* *STO SBC delay*) is positive or zero (0 ms), the SBC and STO functions are activated at the same time.

Example 2: SBC speed limit (parameter *SBC.14* *STO SBC speed*) is reached in the STO function (and SSE with immediate STO), requires an encoder:

- **With an encoder:** parameter *FSOGEN.32 Zero speed delay time* = 20 ms.

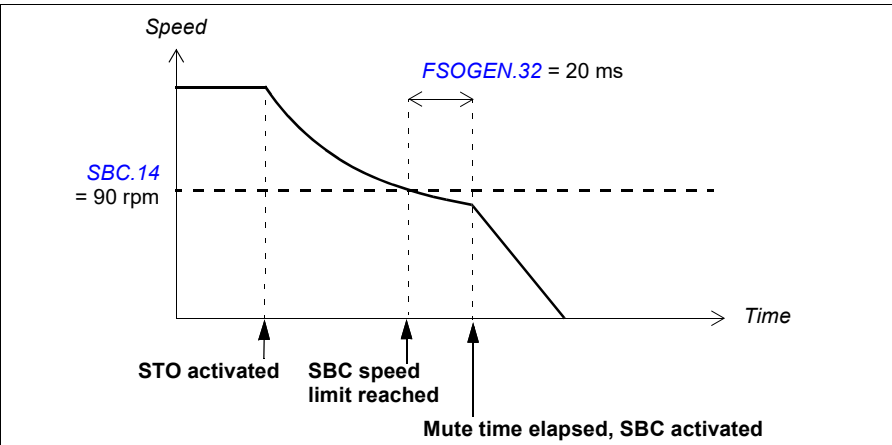

■ How to configure mute time for monitoring start

Example: The start of SLS monitoring in the SLS1 function

In this example, SLS1 function is requested from a higher speed than the SLS trip limit.

- **With an encoder:** parameter *FSOGEN.33 Monitoring start delay* = 20 ms
- **Without an encoder:** parameter *FSOGEN.31 Transient mute time* = 20 ms.

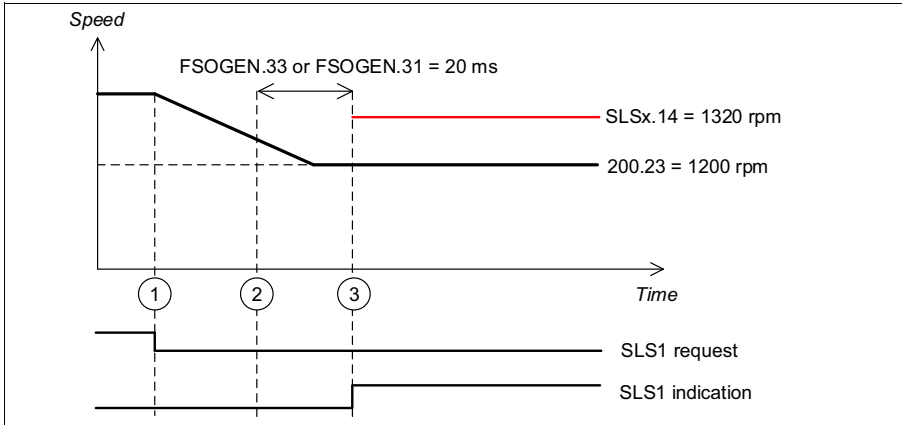

- 1 SLS request activated
- 2 Safe speed in the middle of SLS and SLS trip limits
- 3 SLS monitoring started. SLS indication activates (*SLSx.15*, *SLSx.16*).



Parameters

Contents of this chapter

This chapter describes the parameters and the status and control words of the FSO module.

FSO-21 parameters

The following table lists the FSO-21 parameters: The parameter row shows the parameter index, name, description and factory default value. The subsequent rows show the parameter value range or names, descriptions and numerical values of the selectable named alternatives. You can view and modify these parameters in the Safety settings window of the Drive Composer pro PC tool.

Note: The factory default values shown in the table can be different from the pre-set parameter values in a delivered FSO (ordered with a plus code, eg, +Q972). For more information, see section [Factory reset](#) on page [513](#).

Note: ABB recommends that you set drive parameter *31.22 STO indication run/stop* to value 3, 4 or 5. This setting prevents the drive from making a fault every time the FSO opens the drive STO circuit. You can configure the FSO module so that it generates the necessary faults to the drive event system.

For additional information on drive parameters and their settings, see the drive firmware manual.

| Index | Name/Value | Description | Factory default |
|--------|---------------------------|--|------------------------------|
| Safety | | General drive safety parameters | |
| 200.11 | FS module type | Module type indicator of the FSO module | FSO-21 |
| 200.12 | FS hardware version | FSO module hardware version indicator | Shows the current HW version |
| 200.13 | FS firmware version | FSO module firmware version indicator | Shows the current FW version |
| 200.16 | FSE module type | Module type indicator of the FSE module in use | FSE-31 |
| 200.17 | FSE hardware version | FSE module hardware version indicator | Shows the current HW version |
| 200.18 | FSE firmware version | FSE module firmware version indicator | Shows the current FW version |
| 200.21 | SLS1 activity and version | Activates or deactivates the SLS1 function and shows the version of the SLS1 function. | <i>Disabled</i> |
| | Disabled | Deactivates the SLS1 function. | |
| | Version 1 | Activates version 1 of the SLS1 function. | |
| 200.22 | SLS1 limit negative | Sets the SLS1 negative speed limit for the drive | 0.0 rpm |
| | -35880.0 ...0.0 rpm | Speed | |
| 200.23 | SLS1 limit positive | Sets the SLS1 positive speed limit for the drive | 0.0 rpm |
| | 0.0...35880.0 rpm | Speed | |
| 200.31 | SLS2 activity and version | Activates or deactivates the SLS2 function and shows the version of the SLS2 function. | <i>Disabled</i> |
| | Disabled | Deactivates the SLS2 function. | |
| | Version 1 | Activates version 1 of the SLS2 function. | |
| 200.32 | SLS2 limit negative | Sets the SLS2 negative speed limit for the drive. | 0.0 rpm |
| | -35880.0 ...0.0 rpm | Speed | |
| 200.33 | SLS2 limit positive | Sets the SLS2 positive speed limit for the drive. | 0.0 rpm |
| | 0.0...35880.0 rpm | Speed | |
| 200.41 | SLS3 activity and version | Activates or deactivates the SLS3 function and shows the version of the SLS3 function. | <i>Disabled</i> |
| | Disabled | Deactivates the SLS3 function. | |
| | Version 1 | Activates version 1 of the SLS3 function. | |
| 200.42 | SLS3 limit negative | Sets the SLS3 negative speed limit for the drive. | 0.0 rpm |

| Index | Name/Value | Description | Factory default |
|--------|-----------------------------------|---|-----------------|
| | -35880.0 ...0.0 rpm | Speed | |
| 200.43 | SLS3 limit positive | Sets the SLS3 positive speed limit for the drive | 0.0 rpm |
| | 0.0...35880.0 rpm | Speed | |
| 200.51 | SLS4 activity and version | Activates or deactivates the SLS4 function and shows the version of the SLS4 function. | <i>Disabled</i> |
| | Disabled | Deactivates the SLS4 function. | |
| | Version 1 | Activates version 1 of the SLS4 function. | |
| 200.52 | SLS4 limit negative | Sets the SLS4 negative speed limit for the drive.
Note: Variable SLS uses this limit as scaled. See Defining the scaled SLS4 limit and SLS4 trip limits on page 372. | 0.0 rpm |
| | -35880.0 ...0.0 rpm | Speed | |
| 200.53 | SLS4 limit positive | Sets the SLS4 positive speed limit for the drive.
Note: Variable SLS uses this limit as scaled. See Defining the scaled SLS4 limit and SLS4 trip limits on page 372. | 0.0 rpm |
| | 0.0...35880.0 rpm | Speed | |
| 200.61 | SLS variable activity and version | Activates or deactivates the Variable SLS function and shows the version of the Variable SLS function.
Note: This function can be activated only when the safety fieldbus is installed. | <i>Disabled</i> |
| | Disabled | Deactivates the Variable SLS function. | |
| | Version 1 | Activates version 1 of the Variable SLS function. | |
| 200.71 | SMS activity and version | Activates or deactivates the SMS function and shows the version of the SMS function. | <i>Disabled</i> |
| | Disabled | Deactivates the SMS function. | |
| | Version 1 | Activates version 1 of the SMS function. See section SMS function, version 1 on page 179. | |
| | Version 2 | Activates version 2 of the SMS function. See section SMS function, version 2 on page 180. | |
| 200.72 | SMS limit negative | Sets the negative speed limit for the SMS function.
Note: This parameter is used only in version 2 of the SMS function. | 0.0 rpm |
| | -35880.0 ...0.0 rpm | Speed | |

| Index | Name/Value | Description | Factory default |
|---------|--------------------------------|---|------------------|
| 200.73 | SMS limit positive | Sets the positive speed limit for the SMS function.
Note: This parameter is used only in version 2 of the SMS function. | 0.0 rpm |
| | 0.0...35880.0 rpm | Speed | |
| 200.101 | SAR0 version | Shows the version of the SAR0 function. | <i>Version 1</i> |
| | Version 1 | Version 1. | |
| 200.102 | SAR0 ramp time to zero | Sets the target time for the SAR0 ramp (used in the SSE function).
Target time = Time in which the drive decelerates the motor from speed 200.202 SAR speed scaling to zero. | 1 ms |
| | 1...1,800,000 ms | Time | |
| 200.111 | SAR1 version | Shows the version of the SAR1 function. | <i>Version 1</i> |
| | Version 1 | Version 1. | |
| 200.112 | SAR1 ramp time to zero | Sets the target time for the SAR1 ramp (used in the SS1 and SLS functions).
Target time = Time in which the drive decelerates the motor from speed 200.202 SAR speed scaling to zero.
Note: With value <i>0 ms</i> , the drive (parameter 23.23 Emergency stop time) defines the safe stop ramp. The FSO module monitors the actual ramp using SAR1 parameters (ramp monitoring) or parameter SS1.14 SS1-t delay for STO (time monitoring). | 1 ms |
| | 0...1,800,000 ms | Time. | |
| 200.201 | Drive general settings version | Shows the version of the drive general safety settings (includes parameters 200.202 , 200.222 , 200.223 and 200.254). | <i>Version 1</i> |
| | Version 1 | Version 1. | |
| 200.202 | SAR speed scaling | Sets a speed value that the FSO module uses as a reference point in ramp time calculations.
See section Ramp monitoring on page 57. | 1500 rpm |
| | 0...35880 rpm | Speed | |
| 200.222 | Safety bus type | Sets the type of the safety fieldbus (if used).
Note: To activate the safety fieldbus, you must also set parameter SBUSGEN. 01 SBUS activity and version to value <i>Version 1</i> . | <i>Not used</i> |
| | Not used | The safety fieldbus is not used. | |
| | PROFIsafe | PROFIsafe | |

| Index | Name/Value | Description | Factory default |
|---------|------------------------------|---|---------------------------|
| 200.223 | Safety fieldbus adapter slot | Sets the slot in which the safety fieldbus adapter is installed.
Note: The slots on the drive control board are defined by drive parameters <i>50.01</i> (FBA A) and <i>50.31</i> (FBA B). See the drive firmware manual. | <i>FBA A</i> |
| | FBA A | The safety fieldbus adapter is in slot FBA A. | |
| | FBA B | The safety fieldbus adapter is in slot FBA B. | |
| 200.231 | FSE 3X act and par version | Activates or deactivates the FSE-3x encoder interface and shows the version of the encoder parameter groups (includes groups 91 <i>Enc module settings</i> and 92 <i>Encoder 1 configuration</i>). | <i>Disabled</i> |
| | Disabled | Deactivates the FSE-3x encoder interface. | |
| | Version 1 | Activates the FSE-3x encoder interface. | |
| 200.232 | Number of encoders | Sets the number of encoders that are connected to the FSE module and, in the single encoder case, also the channel that it is connected to.
Note: ACS880 primary control program, version 2.21 supports only one safety pulse encoder.
Note: DCS880 firmware version 2.07 supports only one safety pulse encoder.
This parameter is read-only. | <i>Single encoder CH1</i> |
| | Single encoder CH1 | | |
| 200.254 | CRC of the configuration | Shows the FSO configuration checksum. | 0 |
| | 0...65535 | Checksum | |

| FSOGEN | | General FSO parameters | |
|-----------|------------------------------|---|------------------|
| FSOGEN.01 | FSO general settings version | Shows the version of the FSO general parameter group (includes parameter groups <i>FSOGEN</i> and <i>SAFEIO</i> and parameters <i>SLSx.02</i> , <i>SLSx.03</i> , <i>SLSx.04</i> , <i>SARx.02</i>). | <i>Version 1</i> |
| | Version 1 | Version 1. | |
| FSOGEN.11 | Stop completed output | Sets the digital output that indicates the completion of any stop function. Active when the FSO module has completed the STO, SSE or SS1 function. | <i>None</i> |
| | None | No input connected | |
| | DO X113:7 & X114:7 | Redundant output X113:7 & X114:7 | |
| | DO X113:8 & X114:8 | Redundant output X113:8 & X114:8 | |

| Index | Name/Value | Description | Factory default |
|-----------|-------------------------|--|-----------------|
| | DO X113:9 & X114:9 | Redundant output X113:9 & X114:9 | |
| | DO X113:7 | Single output X113:7 | |
| | DO X113:8 | Single output X113:8 | |
| | DO X113:9 | Single output X113:9 | |
| | DO X114:7 | Single output X114:7 | |
| | DO X114:8 | Single output X114:8 | |
| | DO X114:9 | Single output X114:9 | |
| FSOGEN.21 | Motor nominal speed | Sets the synchronous motor speed. | 100.0 rpm |
| | 1.0 ...35880.0 rpm | Speed | |
| FSOGEN.22 | Motor nominal frequency | Sets the nominal motor frequency.
Note: For a DCS880 drive, this value must be set to 25 Hz. | 1.00 Hz |
| | 1.00...598.00 Hz | Frequency | |
| FSOGEN.31 | Transient mute time | Sets the mute time for the safe speed functions. The FSO module waits for the transient mute time before it acts after a ramp monitoring or trip limit hit, or after the zero speed limit is reached.
<u>When an encoder is used:</u> This parameter is used only in ramp monitoring and trip limit hit situations. | 0 ms |
| | 0...1000 ms | Time | |
| FSOGEN.32 | Zero speed delay time | Sets the time for how long the motor speed must stay inside zero speed limits in order to determine the motor as stopped.
Note: This parameter is relevant only when an encoder is used. Without an encoder, parameter FSOGEN.31 is used. See also section Configuring mute times on page 395 . | 0 ms |
| | 0...1000 ms | Time | |
| FSOGEN.33 | Monitoring start delay | Sets the time for how long the speed must stay in the correct side of a limit in order to determine that the limit is reached and monitoring can be started.
Note: This parameter is relevant only when an encoder is used. Without an encoder, parameter FSOGEN.31 is used. See also section Configuring mute times on page 395 . | 0 ms |
| | 0...1000 ms | Time | |

| Index | Name/Value | Description | Factory default |
|-----------|------------------------------|---|------------------------|
| FSOGEN.38 | Enable SLSx mute times | Enables SLS-specific mute times which are used in SLS limit hit situations.
These mute times can be set with parameters SLSx.17 , SLSx.27 , SLSx.37 , SLSx.47 and SLSx.57 . These parameters are effective only with the safe speed estimate.
When this parameter is disabled, FSOGEN.31 is used in limit hit situations. | Disabled |
| | Disabled | Deactivates SLSx mute times | |
| | Enabled | Activates SLSx mute times | |
| FSOGEN.39 | Enable SMS mute time | Enables SMS-specific mute time, which is used in limit hit situations and can be set with parameter SMS.17 . This parameter is effective only with the safe speed estimate.
When this parameter is disabled, FSOGEN.31 is used in limit hit situations. | Disabled |
| | Disabled | Deactivates SMS mute time | |
| | Enabled | Activates SMS mute time | |
| FSOGEN.41 | Power-up acknowledgement | Sets the power-up acknowledgement method.
Note: If a safety function request is active when the FSO module is rebooted, the request must be removed before the power-up acknowledgement is accepted. | Manual |
| | Manual | The FSO module reads an external acknowledgement signal through the digital input defined by parameter FSOGEN.42 Acknowledgement button input . | |
| | Automatic | The FSO module generates the acknowledgement signal automatically after the power-up. | |
| | Safebus | The FSO module expects an external acknowledgement signal from the safety fieldbus after the power-up. | |
| | Manual_Safebus | The FSO module expects an external acknowledgement signal either from a digital input or from the safety fieldbus after the power-up. | |
| FSOGEN.42 | Acknowledgement button input | Sets the digital input that is connected to the button for acknowledgement operations. | None |
| | None | No input connected | |
| | DI X113:1 | Single input X113:1 | |
| | DI X113:2 | Single input X113:2 | |

| Index | Name/Value | Description | Factory default |
|-----------|----------------------------|---|-----------------|
| | DI X113:3 | Single input X113:3 | |
| | DI X113:4 | Single input X113:4 | |
| | DI X114:1 | Single input X114:1 | |
| | DI X114:2 | Single input X114:2 | |
| | DI X114:3 | Single input X114:3 | |
| | DI X114:4 | Single input X114:4 | |
| FSOGEN.51 | Zero speed without encoder | <p>Sets the zero speed limit for ramp stop safety functions. Used to define when the safety function is completed and can be acknowledged.</p> <p>Note: This is the absolute value. The same value is used in both positive and negative directions.</p> <p>Note: You cannot set trip limits below this value.</p> | 0.0 rpm |
| | 0.0...600.0 rpm | Speed | |
| FSOGEN.52 | Zero speed with encoder | <p>Sets the zero speed limit for safe stopping functions. Used to define when the safety function is completed and can be acknowledged.</p> <p>Note: This is the absolute value. The same value is used in both positive and negative directions.</p> <p>Note: You cannot set trip limits below this value.</p> <p>Note: It is recommended to use a value higher than 0.5 rpm.</p> | 0.0 rpm |
| | 0.0...600.0 rpm | Speed | |
| FSOGEN.61 | STO indication ext request | <p>Sets the type of the event that the FSO module generates and sends to the drive after external requests that end to a successful activation of the drive STO function (STO, SSE or SS1).</p> <p>Note: When the FSO module triggers the STO function in fault situations, it always generates a fault.</p> | <i>Fault</i> |
| | None | No event generated | |
| | Fault | Fault generated | |
| | Warning | Warning generated | |
| | Event | Pure event generated | |

| Index | Name/Value | Description | Factory default |
|------------|--------------------------------|--|-----------------|
| FSOGEN.62 | STO indication safety limit | Sets the type of the event that the FSO module generates for limit hits in the SLS1, ..., SLS4 and SMS functions and for limit hits during ramp and time monitoring of safety ramps SAR0 and SAR1.
Note: When the FSO module triggers the STO function in fault situations, it always generates a fault. | <i>Fault</i> |
| | None | No event generated | |
| | Fault | Fault generated | |
| | Warning | Warning generated | |
| | Event | Pure event generated | |
| FSOGEN.254 | CRC of the whole configuration | Shows the FSO configuration checksum. | 0 |
| | 0...65535 | Checksum | |

| STO | | Parameters for the STO function | |
|--------|---------------------|---|------------------|
| STO.01 | STO version | Shows the version of the STO function. | <i>Version 1</i> |
| | Version 1 | Version 1. | |
| STO.02 | STO acknowledgement | Sets the acknowledgement method used in the STO, SSE and SS1 functions.
See section Acknowledgement methods on page 55 for more information on different acknowledgement methods. | <i>Manual</i> |
| | Manual | The FSO module reads the external STO acknowledgement signal through the digital input defined by parameter FSOGEN.42 Acknowledgement button input . The FSO module accepts the acknowledgement after the STO, SSE or SS1 request has been removed and the stop function is completed (output defined by parameter FSOGEN.11 STO completed output is active). | |
| | Automatic | The FSO module generates the STO acknowledgement signal automatically after the STO, SSE or SS1 request has been removed and the stop function is completed (output defined by parameter FSOGEN.11 STO completed output is active). | |
| | Safebus | The FSO module expects an external STO acknowledgement signal from the safety fieldbus after the STO, SSE or SS1 request has been removed and the stop function is completed (output defined by parameter FSOGEN.11 STO completed output is active). | |

| Index | Name/Value | Description | Factory default |
|-------|--------------------|--|-------------------------------|
| | Manual_Safebus | The FSO module expects an external STO acknowledgement signal either from a digital input or from the safety fieldbus after the STO, SSE or SS1 request has been removed and the stop function is completed (output defined by parameter <i>FSOGEN.11 STO completed output</i> is active). | |
| | STO.11 STO input A | Sets the digital input that is connected to the primary input of the STO function. | <i>DI X113:1 & X114:1</i> |
| | None | No input connected | |
| | DI X113:1 & X114:1 | Redundant input X113:1 & X114:1 | |
| | DI X113:2 & X114:2 | Redundant input X113:2 & X114:2 | |
| | DI X113:3 & X114:3 | Redundant input X113:3 & X114:3 | |
| | DI X113:4 & X114:4 | Redundant input X113:4 & X114:4 | |
| | DI X113:1 | Single input X113:1 | |
| | DI X113:2 | Single input X113:2 | |
| | DI X113:3 | Single input X113:3 | |
| | DI X113:4 | Single input X113:4 | |
| | DI X114:1 | Single input X114:1 | |
| | DI X114:2 | Single input X114:2 | |
| | DI X114:3 | Single input X114:3 | |
| | DI X114:4 | Single input X114:4 | |
| | STO.12 STO input B | Sets the digital input that is connected to the secondary input of the STO function. The secondary input is mostly used for the cascade connection.
See parameters <i>SAFEIO.12 Cascade A</i> and <i>SAFEIO.13 Cascade B</i> . | <i>None</i> |
| | None | No input connected | |
| | DI X113:1 & X114:1 | Redundant input X113:1 & X114:1 | |
| | DI X113:2 & X114:2 | Redundant input X113:2 & X114:2 | |
| | DI X113:3 & X114:3 | Redundant input X113:3 & X114:3 | |
| | DI X113:4 & X114:4 | Redundant input X113:4 & X114:4 | |
| | DI X113:1 | Single input X113:1 | |
| | DI X113:2 | Single input X113:2 | |
| | DI X113:3 | Single input X113:3 | |
| | DI X113:4 | Single input X113:4 | |
| | DI X114:1 | Single input X114:1 | |
| | DI X114:2 | Single input X114:2 | |
| | DI X114:3 | Single input X114:3 | |
| | DI X114:4 | Single input X114:4 | |

| Index | Name/Value | Description | Factory default |
|--------|--|---|-----------------|
| STO.13 | Restart delay after STO | <p>Sets the time after which the acknowledgement of the FSO module and restart of the drive are allowed after the FSO has activated the STO function and opened the drive STO circuit. With this parameter, you can allow a restart of the drive before the motor has stopped (fly-start).</p> <p>This parameter is relevant only when an external request activates the STO function. If you do not want to use the fly-start feature, set this parameter to the same value as parameter STO.14 Time to zero speed with STO and modoff.</p> | 3,600,000 ms |
| | 0...3,600,000 ms | Time | |
| STO.14 | Time to zero speed with STO and modoff | <p>Sets the time that is needed to coast the motor to a standstill from maximum process speed. If this time is not known, it can be measured with Drive Composer pro PC tool when an encoder is used for motor control (otherwise you have to make sure that the motor shaft has stopped rotating by other means, eg, visually).</p> <p>Acknowledgement is allowed after coast stop in the STO, SSE and SS1 functions (when SBC is not used).</p> <p>If SBC is used, see parameter SBC.13 SBC time to zero speed.</p> <p>If an external request activates the STO function, this parameter sets the time after which the function is completed and the STO completed indication goes on. In this case, parameter STO.13 Restart delay after STO defines the time after which the acknowledgement is allowed.</p> <p>If the drive STO is activated or modulation stopped while a monitoring safety function is indicating “unsafe”, after this time acknowledgement is allowed. For example, if the drive modulation is lost during SLS deceleration ramp, SLS OK will be indicated after this time has elapsed. See section SLS trip limit hits on page 168.</p> <p><u>When an encoder is used:</u> This parameter is relevant only if there is an encoder failure and the FSO module activates the STO function.</p> | 3,600,000 ms |

| Index | Name/Value | Description | Factory default |
|--------|----------------------|--|-----------------|
| | 0...3,600,000 ms | Time | |
| STO.21 | STO output | Sets the digital output that indicates the status of the STO function in the drive.
Active when the STO circuit in the drive is open.
Note: In a cascade connection, this indicates the activity of the STO function of the FSO module. | <i>None</i> |
| | None | No output connected | |
| | DO X113:7 & X114:7 | Redundant output X113:7 & X114:7 | |
| | DO X113:8 & X114:8 | Redundant output X113:8 & X114:8 | |
| | DO X113:9 & X114:9 | Redundant output X113:9 & X114:9 | |
| | DO X113:7 | Single output X113:7 | |
| | DO X113:8 | Single output X113:8 | |
| | DO X113:9 | Single output X113:9 | |
| | DO X114:7 | Single output X114:7 | |
| | DO X114:8 | Single output X114:8 | |
| | DO X114:9 | Single output X114:9 | |
| STO.22 | STO completed output | Sets the digital output that indicates the completion of the STO function. See the diagrams in section <i>Safe torque off (STO)</i> on page 68. | <i>None</i> |
| | None | No output connected | |
| | DO X113:7 & X114:7 | Redundant output X113:7 & X114:7 | |
| | DO X113:8 & X114:8 | Redundant output X113:8 & X114:8 | |
| | DO X113:9 & X114:9 | Redundant output X113:9 & X114:9 | |
| | DO X113:7 | Single output X113:7 | |
| | DO X113:8 | Single output X113:8 | |
| | DO X113:9 | Single output X113:9 | |
| | DO X114:7 | Single output X114:7 | |
| | DO X114:8 | Single output X114:8 | |
| | DO X114:9 | Single output X114:9 | |

| SBC | Parameters for the SBC function | |
|--------|---------------------------------|--|
| SBC.01 | SBC version | Shows the version of the SBC function. |
| | Version 1 | Version 1. |
| SBC.11 | STO SBC usage | Sets how the mechanical brake (SBC) is used together with the STO function.
Note: This parameter is used also in the SSE function when it is configured as <i>Immediate STO</i> (parameter <i>SSE.13 SSE function = Immediate STO</i>). |
| | None | No brake |

| Index | Name/Value | Description | Factory default |
|--------|--------------------------|--|-----------------|
| | Delayed brake | Time controlled brake. Parameter SBC.12 STO SBC delay defines the delay. | |
| | Speed limit | <p>The brake is activated below a user-defined speed limit (parameter SBC.14 STO SBC speed). Requires that an encoder is used.</p> <p>Note: If an encoder or FSE failure occurs, and the STO function is not active, the FSO module starts to use the <i>Delayed brake</i> setting. If the STO function is already active, the action depends on the value of parameter S_ENCGEN.11 FSE diagnostic failure reaction. See section <i>How to configure STO with speed limit activated SBC</i> on page 339.</p> | |
| SBC.12 | STO SBC delay | <p>Sets the time when the SBC function will be activated in relation to the activation of the STO function. A negative value means that the FSO module activates the SBC before the drive STO function.</p> <p>If the value is <i>0 ms</i>, the FSO activates the drive STO and SBC functions at the same time.</p> <p><u>STO function and SSE with immediate STO:</u>
This parameter is valid if parameter SBC.11 STO SBC usage has value <i>Delayed brake</i>.</p> <p><u>SSE with emergency ramp and SS1 function:</u> This parameter is valid if parameter SBC.15 SSE/SS1 SBC speed is not zero. Only a negative value and zero are used. If the value is positive, it is regarded as zero.</p> <p>Note: You must include the mechanical brake delays in this value.</p> | 3,600,000 ms |
| | -5000...
3,600,000 ms | Time | |

| Index | Name/Value | Description | Factory default |
|--------|------------------------|---|-----------------|
| SBC.13 | SBC time to zero speed | <p>Sets the estimated time from the SBC activation to the moment when the safety function is completed and the STO completed indication (parameter STO.22) goes on (ie, motor has stopped and the system can be set to a safe state).</p> <p>Must be configured to the estimated time in which the external brake decelerates the motor to a stop from the maximum speed.</p> <p>The total delay from the moment the FSO module has activated the drive STO function until the system is in safe state becomes: STO SBC delay (SBC.12) + SBC time to zero speed (SBC.13).</p> <p>Note: If the value of SBC time to zero speed (SBC.13) is less than 800 ms (the feedback delay), the total delay becomes: STO SBC delay (SBC.12) + 800 ms.</p> <p><u>When an encoder is used:</u> This parameter is relevant only if there is an encoder failure and the FSO module activates the STO and SBC functions.</p> | 3,600,000 ms |
| | 0...3,600,000 ms | Time | |
| SBC.14 | STO SBC speed | <p>Sets the speed limit below which the FSO module activates the brake (SBC) in the STO function. Requires that an encoder is used and parameter SBC.11 STO SBC usage is set to value <i>Speed limit</i>. If the value is <i>0.0 rpm</i>, this feature is not in use.</p> <p>Note: This is the absolute value. The same value is used in both positive and negative directions.</p> | 0.0 rpm |
| | 0.0...1000.0 rpm | Speed | |
| SBC.15 | SSE/SS1 SBC speed | <p>Sets the speed below which the FSO module activates the brake (SBC) while ramping in the SSE and SS1 functions. If the value is <i>0.0 rpm</i>, this feature is not in use.</p> <p>Note: This is the absolute value. The same value is used in both positive and negative directions.</p> | 0.0 rpm |
| | 0.0...1000.0 rpm | Speed | |
| SBC.21 | SBC output | Sets the digital output that is connected to the SBC output (brake relays). | <i>None</i> |
| | None | No output connected | |
| | DO X113:7 & X114:7 | Redundant output X113:7 & X114:7 | |

| Index | Name/Value | Description | Factory default |
|--------|---------------------|---|-----------------|
| | DO X113:8 & X114:8 | Redundant output X113:8 & X114:8 | |
| | DO X113:9 & X114:9 | Redundant output X113:9 & X114:9 | |
| SBC.22 | SBC feedback action | Sets the action that the FSO module takes when there is a problem with the SBC feedback. | <i>No STO</i> |
| | STO | The FSO module goes into the Fail-safe mode and activates the drive STO function. | |
| | No STO | The FSO module sends a warning to the drive. | |
| SBC.23 | SBC test OK signal | Sets the digital output that indicates the status of the SBC test OK signal. Active when the SBC feedback indicates that the SBC works correctly.
Note: The feedback delay is 800 ms. | <i>None</i> |
| | None | No output connected | |
| | DO X113:7 & X114:7 | Redundant output X113:7 & X114:7 | |
| | DO X113:8 & X114:8 | Redundant output X113:8 & X114:8 | |
| | DO X113:9 & X114:9 | Redundant output X113:9 & X114:9 | |
| | DO X113:7 | Single output X113:7 | |
| | DO X113:8 | Single output X113:8 | |
| | DO X113:9 | Single output X113:9 | |
| | DO X114:7 | Single output X114:7 | |
| | DO X114:8 | Single output X114:8 | |
| | DO X114:9 | Single output X114:9 | |

| POUS | | Parameters for the POUS function | |
|---------|---------------------------|---|-----------------|
| POUS.01 | POUS activity and version | Activates or deactivates the POUS function and shows the version of the POUS function. | <i>Disabled</i> |
| | Disabled | Deactivates the POUS function. | |
| | Version 1 | Activates version 1 of the POUS function. | |
| POUS.02 | POUS acknowledgement | Sets the POUS acknowledgement method. | <i>Manual</i> |
| | Manual | The FSO module reads the POUS acknowledgement signal through the digital input defined by parameter <i>FSOGEN.42 Acknowledgement button input</i> . The FSO module accepts the acknowledgement after the POUS request has been removed. | |
| | Automatic | The FSO module generates the POUS acknowledgement signal automatically after the POUS request has been removed. | |

| Index | Name/Value | Description | Factory default |
|---------|---------------------------|--|-----------------|
| | Safebus | The FSO module expects an external POUS acknowledgement signal from the safety fieldbus after the POUS request has been removed. | |
| | Manual_Safebus | The FSO module expects an external POUS acknowledgement signal either from a digital input or from the safety fieldbus after the POUS request have been removed. | |
| POUS.11 | POUS input | Sets the digital input that is connected to the POUS input. | <i>None</i> |
| | None | No input connected | |
| | DI X113:1 & X114:1 | Redundant input X113:1 & X114:1 | |
| | DI X113:2 & X114:2 | Redundant input X113:2 & X114:2 | |
| | DI X113:3 & X114:3 | Redundant input X113:3 & X114:3 | |
| | DI X113:4 & X114:4 | Redundant input X113:4 & X114:4 | |
| | DI X113:1 | Single input X113:1 | |
| | DI X113:2 | Single input X113:2 | |
| | DI X113:3 | Single input X113:3 | |
| | DI X113:4 | Single input X113:4 | |
| | DI X114:1 | Single input X114:1 | |
| | DI X114:2 | Single input X114:2 | |
| | DI X114:3 | Single input X114:3 | |
| | DI X114:4 | Single input X114:4 | |
| POUS.13 | POUS delay for completion | Sets the delay for the activation of the POUS complete indication after the POUS request. | 0 ms |
| | 0...3,600,000 ms | Time | |
| POUS.21 | POUS output | Sets the digital output that indicates the activity of the POUS function. Active from the POUS request until the function has been acknowledged. | <i>None</i> |
| | None | No output connected | |
| | DO X113:7 & X114:7 | Redundant output X113:7 & X114:7 | |
| | DO X113:8 & X114:8 | Redundant output X113:8 & X114:8 | |
| | DO X113:9 & X114:9 | Redundant output X113:9 & X114:9 | |
| | DO X113:7 | Single output X113:7 | |
| | DO X113:8 | Single output X113:8 | |
| | DO X113:9 | Single output X113:9 | |
| | DO X114:7 | Single output X114:7 | |
| | DO X114:8 | Single output X114:8 | |
| | DO X114:9 | Single output X114:9 | |

| Index | Name/Value | Description | Factory default |
|---------|-----------------------|---|-----------------|
| POUS.22 | POUS completed output | Set the digital output that indicates the completion of the POUS function. Active after the time defined by parameter POUS.13 POUS delay for completion has elapsed from the POUS request until the POUS request has been removed.
Note: Connect the POUS indication lamp to this output. | <i>None</i> |
| | None | No output connected | |
| | DO X113:7 & X114:7 | Redundant output X113:7 & X114:7 | |
| | DO X113:8 & X114:8 | Redundant output X113:8 & X114:8 | |
| | DO X113:9 & X114:9 | Redundant output X113:9 & X114:9 | |
| | DO X113:7 | Single output X113:7 | |
| | DO X113:8 | Single output X113:8 | |
| | DO X113:9 | Single output X113:9 | |
| | DO X114:7 | Single output X114:7 | |
| | DO X114:8 | Single output X114:8 | |
| | DO X114:9 | Single output X114:9 | |

| SSE | | Parameters for the SSE function | |
|--------|--------------------|--|------------------|
| SSE.01 | SSE version | Shows the version of the SSE function. | <i>Version 1</i> |
| | Version 1 | Version 1. | |
| SSE.11 | SSE input A | Sets the digital input that is connected to the primary input of the SSE function. | <i>None</i> |
| | None | No input connected | |
| | DI X113:1 & X114:1 | Redundant input X113:1 & X114:1 | |
| | DI X113:2 & X114:2 | Redundant input X113:2 & X114:2 | |
| | DI X113:3 & X114:3 | Redundant input X113:3 & X114:3 | |
| | DI X113:4 & X114:4 | Redundant input X113:4 & X114:4 | |
| | DI X113:1 | Single input X113:1 | |
| | DI X113:2 | Single input X113:2 | |
| | DI X113:3 | Single input X113:3 | |
| | DI X113:4 | Single input X113:4 | |
| | DI X114:1 | Single input X114:1 | |
| | DI X114:2 | Single input X114:2 | |
| | DI X114:3 | Single input X114:3 | |
| | DI X114:4 | Single input X114:4 | |

| Index | Name/Value | Description | Factory default |
|--------|-----------------------|---|-----------------------|
| SSE.12 | SSE input B | Sets the digital input that is connected to the secondary input of the SSE function. The secondary input is mostly used for the cascade connection.
See parameters SAFEIO.12 Cascade A and SAFEIO.13 Cascade B . | <i>None</i> |
| | None | No input connected | |
| | DI X113:1 & X114:1 | Redundant input X113:1 & X114:1 | |
| | DI X113:2 & X114:2 | Redundant input X113:2 & X114:2 | |
| | DI X113:3 & X114:3 | Redundant input X113:3 & X114:3 | |
| | DI X113:4 & X114:4 | Redundant input X113:4 & X114:4 | |
| | DI X113:1 | Single input X113:1 | |
| | DI X113:2 | Single input X113:2 | |
| | DI X113:3 | Single input X113:3 | |
| | DI X113:4 | Single input X113:4 | |
| | DI X114:1 | Single input X114:1 | |
| | DI X114:2 | Single input X114:2 | |
| | DI X114:3 | Single input X114:3 | |
| | DI X114:4 | Single input X114:4 | |
| SSE.13 | SSE function | Sets the type of the SSE function. | <i>Emergency ramp</i> |
| | Immediate STO | The FSO module activates the drive STO immediately after the SSE request. | |
| | Emergency ramp | The FSO module activates the drive STO after an emergency ramp. | |
| SSE.14 | SSE monitoring method | Sets the method used for the SSE emergency ramp monitoring. This parameter is relevant only if parameter SSE.13 SSE function is set to Emergency ramp . | <i>Ramp</i> |
| | Ramp | Ramp monitoring. SAR0 parameters define the emergency ramp and monitoring limits. See parameters 200.102 , SARx.11 , SARx.12 and SARx.02 . | |
| | Time | Time monitoring. Parameter 200.102 SAR0 ramp time to zero defines the emergency ramp and it is monitored with parameter SSE.15 SSE delay for STO . | |
| SSE.15 | SSE delay for STO | Sets the delay for STO activation after the SSE request.
This parameter is relevant only if parameter SSE.13 SSE function is set to Emergency ramp , time monitoring is used (SSE.14 SSE monitoring method = Time) and the motor speed does not follow the ramp. | 3,600,000 ms |

| Index | Name/Value | Description | Factory default |
|--------|-----------------------------------|---|-----------------|
| | 0...3,600,000 ms | Time | |
| SSE.16 | SSE ramp zero speed delay for STO | <p>Sets an extra delay time for the drive STO (and SBC, if used) activation at the zero speed limit in the SSE with emergency ramp function.</p> <p>With this parameter, the FSO module delays the STO activation so that the drive is able to reach the shaft zero speed before the FSO module activates the drive STO function. The delay counter starts when the motor speed reaches the zero speed limit (parameter FSOGEN.51 or FSOGEN.52). After this delay has elapsed, the FSO module activates the drive STO function. You can use this parameter when the motor rotates a heavy load (high inertia).</p> <p>Note: The FSO module activates the drive STO immediately if the drive stops modulating before this delay has passed (that is, the motor actual speed reaches 0 rpm).</p> | 30,000 ms |
| | 0...30,000 ms | Time | |
| SSE.21 | SSE output | Sets the digital output that indicates the activity of the SSE function. Active from the SSE request until the function has been acknowledged. | <i>None</i> |
| | None | No output connected | |
| | DO X113:7 & X114:7 | Redundant output X113:7 & X114:7 | |
| | DO X113:8 & X114:8 | Redundant output X113:8 & X114:8 | |
| | DO X113:9 & X114:9 | Redundant output X113:9 & X114:9 | |
| | DO X113:7 | Single output X113:7 | |
| | DO X113:8 | Single output X113:8 | |
| | DO X113:9 | Single output X113:9 | |
| | DO X114:7 | Single output X114:7 | |
| | DO X114:8 | Single output X114:8 | |
| | DO X114:9 | Single output X114:9 | |
| SSE.22 | SSE completed output | Sets the digital output that indicates the completion of the SSE function. See the diagrams in section Safe stop emergency (SSE) on page 107. | <i>None</i> |
| | None | No output connected | |
| | DO X113:7 & X114:7 | Redundant output X113:7 & X114:7 | |
| | DO X113:8 & X114:8 | Redundant output X113:8 & X114:8 | |
| | DO X113:9 & X114:9 | Redundant output X113:9 & X114:9 | |

| Index | Name/Value | Description | Factory default |
|------------|--------------------------|---|-----------------|
| | DO X113:7 | Single output X113:7 | |
| | DO X113:8 | Single output X113:8 | |
| | DO X113:9 | Single output X113:9 | |
| | DO X114:7 | Single output X114:7 | |
| | DO X114:8 | Single output X114:8 | |
| | DO X114:9 | Single output X114:9 | |
| SS1 | | | |
| SS1 | | Parameters for the SS1 function | |
| SS1.01 | SS1 activity and version | Activates or deactivates the SS1 function and shows the version of the SS1 function. | <i>Disabled</i> |
| | Disabled | Deactivates the SS1 function. | |
| | Version 1 | Activates version 1 of the SS1 function. | |
| SS1.11 | SS1 input A | Sets the digital input that is connected to the primary input of the SS1 function. | <i>None</i> |
| | None | No input connected | |
| | DI X113:1 & X114:1 | Redundant input X113:1 & X114:1 | |
| | DI X113:2 & X114:2 | Redundant input X113:2 & X114:2 | |
| | DI X113:3 & X114:3 | Redundant input X113:3 & X114:3 | |
| | DI X113:4 & X114:4 | Redundant input X113:4 & X114:4 | |
| | DI X113:1 | Single input X113:1 | |
| | DI X113:2 | Single input X113:2 | |
| | DI X113:3 | Single input X113:3 | |
| | DI X113:4 | Single input X113:4 | |
| | DI X114:1 | Single input X114:1 | |
| | DI X114:2 | Single input X114:2 | |
| | DI X114:3 | Single input X114:3 | |
| | DI X114:4 | Single input X114:4 | |
| SS1.12 | SS1 input B | Sets the digital input that is connected to the secondary input of the SS1 function. The secondary input is mostly used for the cascade connection.
See parameters SAFEIO.12 Cascade A and SAFEIO.13 Cascade B . | <i>None</i> |
| | None | No input connected | |
| | DI X113:1 & X114:1 | Redundant input X113:1 & X114:1 | |
| | DI X113:2 & X114:2 | Redundant input X113:2 & X114:2 | |
| | DI X113:3 & X114:3 | Redundant input X113:3 & X114:3 | |
| | DI X113:4 & X114:4 | Redundant input X113:4 & X114:4 | |
| | DI X113:1 | Single input X113:1 | |
| | DI X113:2 | Single input X113:2 | |
| | DI X113:3 | Single input X113:3 | |
| | DI X113:4 | Single input X113:4 | |

| Index | Name/Value | Description | Factory default |
|--------|-------------------------------------|---|-----------------|
| | DI X114:1 | Single input X114:1 | |
| | DI X114:2 | Single input X114:2 | |
| | DI X114:3 | Single input X114:3 | |
| | DI X114:4 | Single input X114:4 | |
| SS1.13 | SS1 type | Sets the SS1 type, that is, the method used for the SS1 monitoring. | <i>SS1-r</i> |
| | SS1-r | Ramp monitoring. SAR1 parameters define the stop ramp and the monitoring limits.
See parameters 200.112 , SARx.21 , SARx.22 and SARx.02 . | |
| | SS1-t | Time monitoring. SAR1 parameter 200.112 define the stop ramp and it is monitored with parameter SS1.14 SS1-t delay for STO . | |
| SS1.14 | SS1-t delay for STO | Sets the time monitoring limit for SS1-t function. See parameter SS1.13 SS1 type .
FSO will activate STO function if the zero speed limit is not reached within this target time.
Note: This parameter is relevant only if time monitoring is used. | 3,600,000 ms |
| | 0...3,600,000 ms | Time | |
| SS1.15 | SS1-r ramp zero speed delay for STO | Sets an extra delay time for the drive STO (and SBC, if used) activation at the zero speed limit in the SS1 function.
With this parameter, the FSO module delays the STO activation so that the drive is able to reach the shaft zero speed before the FSO module activates the STO function.
The delay counter starts when the motor speed reaches the zero speed limit (parameter FSOGEN.51 or FSOGEN.52).
After this delay has elapsed, the FSO module activates the drive STO function.
You can use this parameter when the motor rotates a heavy load (high inertia).
Note: The FSO module activates the drive STO immediately if the drive stops modulating before the delay has passed (that is, the motor actual speed reaches 0 rpm). | 0 ms |
| | 0...120,000 ms | Time | |
| SS1.21 | SS1 output | Sets the digital output that indicates the activity of the SS1 function. Active from the SS1 request until the function has been acknowledged. | <i>None</i> |

| Index | Name/Value | Description | Factory default |
|-------------|----------------------|---|-----------------|
| | None | No output connected | |
| | DO X113:7 & X114:7 | Redundant output X113:7 & X114:7 | |
| | DO X113:8 & X114:8 | Redundant output X113:8 & X114:8 | |
| | DO X113:9 & X114:9 | Redundant output X113:9 & X114:9 | |
| | DO X113:7 | Single output X113:7 | |
| | DO X113:8 | Single output X113:8 | |
| | DO X113:9 | Single output X113:9 | |
| | DO X114:7 | Single output X114:7 | |
| | DO X114:8 | Single output X114:8 | |
| | DO X114:9 | Single output X114:9 | |
| SS1.22 | SS1 completed output | Sets the digital output that indicates the completion of the SS1 function. See the diagrams in section Safe stop 1 (SS1) on page 80. | <i>None</i> |
| | None | No output connected | |
| | DO X113:7 & X114:7 | Redundant output X113:7 & X114:7 | |
| | DO X113:8 & X114:8 | Redundant output X113:8 & X114:8 | |
| | DO X113:9 & X114:9 | Redundant output X113:9 & X114:9 | |
| | DO X113:7 | Single output X113:7 | |
| | DO X113:8 | Single output X113:8 | |
| | DO X113:9 | Single output X113:9 | |
| | DO X114:7 | Single output X114:7 | |
| | DO X114:8 | Single output X114:8 | |
| | DO X114:9 | Single output X114:9 | |
| SLSx | | Parameters for the SLS1...4 functions | |
| SLSx.02 | SLS acknowledgement | Sets the acknowledgement method used in the SLS1...4 functions. | <i>Manual</i> |
| | Manual | The FSO module reads the external SLS acknowledgement signal through the digital input defined by parameter FSOGEN.42 Acknowledgement button input . The FSO module accepts the acknowledgement after the SLS request has been removed and the SLS limit has been achieved (that is, SLS monitoring is on). | |
| | Automatic | The FSO module generates the SLS acknowledgement signal automatically after the SLS request has been removed and the SLS limit has been achieved (that is, SLS monitoring is on). | |

| Index | Name/Value | Description | Factory default |
|-------|--|---|-------------------|
| | Safebus | The FSO module expects an external SLS acknowledgement signal from the safety fieldbus. The FSO module accepts the acknowledgement after the SLS request has been removed and the SLS limit has been achieved (that is, SLS monitoring is on). | |
| | Manual_Safebus | The FSO module expects an external SLS acknowledgement signal either from a digital input or from the safety fieldbus. The FSO module accepts the acknowledgement after the SLS request has been removed and the SLS limit has been achieved (that is, SLS monitoring is on). | |
| | SLSx.03 SLS activation monitoring method | Sets the monitoring method that is used in SLS activation. | <i>Ramp</i> |
| | Ramp | Ramp monitoring. SAR1 parameters define the deceleration ramp and monitoring limits. See parameters 200.112 , SARx.21 , SARx.22 and SARx.02 . | |
| | Time | Time monitoring. The drive (parameter 23.13 or 23.15) defines the deceleration ramp and it is monitored with parameter SLSx.04 SLS time delay . | |
| | SLSx.04 SLS time delay | Sets the latest activation time for SLS monitoring after an SLS request.

This parameter is relevant only if time monitoring is used.

See parameter SLSx.03 SLS activation monitoring method .

Note: With time monitoring, when Monitoring active and Modoff delay time are selected, SLSx.04 and SLSx.06 time must be set shorter than STO.14 , otherwise STO is not activated due to limit hit when drive modulation is lost with SLS function.

Note: If the value of this parameter is set to <i>0 ms</i> , SLS monitoring will be started immediately regardless of the motor speed. | 0 ms |
| | 0...4,000,000 ms | Time | |
| | SLSx.05 SLS ramp modoff reaction | Selects the fault reaction in case the drive modulation is lost during the SLS deceleration ramp, when SLS is activated from speed which is higher than SLS limit speed.

Note: If encoder feedback is in use, SLSx.05 parameter has no effect. | Modoff delay time |

| Index | Name/Value | Description | Factory default |
|---------|---|--|-----------------|
| | Modoff delay time | If drive modulation is lost during the SLS deceleration ramp and the modulation does not return within SLSx.06 time, FSO activates STO.
Note: If speed is below SLS limit (eg, 200.22), modoff is ignored. | |
| | Monitoring active | If drive modulation is lost during the SLS deceleration ramp, SLS ramp or time monitoring (SLSx.03) is kept on. Limit hit is generated based on the last valid speed estimate information of FSO. | |
| | Monitoring active and Modoff delay time | Both Modoff delay time and Monitoring active values are in use: FSO generates the hit based on whichever condition is met first and activates the STO. | |
| | Monitoring and modoff delay time are disabled | If drive modulation is lost during the SLS deceleration ramp, FSO does not activate STO. SLS indication (eg, SLSx.15) goes on after STO.14 time has elapsed. | |
| SLSx.06 | SLS ramp modoff delay time | Time to trip when modulation is lost.
Note: This time must be set shorter than STO.14 , otherwise STO is not activated due to limit hit when drive modulation is lost with SLS function.
Note: If encoder feedback is in use, SLSx.06 parameter has no effect. | 0 ms |
| | 0...3,600,000 ms | Time | |
| SLSx.11 | SLS1 input A | Sets the primary digital input for the SLS1 function. | <i>None</i> |
| | None | No input connected | |
| | DI X113:1 & X114:1 | Redundant input X113:1 & X114:1 | |
| | DI X113:2 & X114:2 | Redundant input X113:2 & X114:2 | |
| | DI X113:3 & X114:3 | Redundant input X113:3 & X114:3 | |
| | DI X113:4 & X114:4 | Redundant input X113:4 & X114:4 | |
| | DI X113:1 | Single input X113:1 | |
| | DI X113:2 | Single input X113:2 | |
| | DI X113:3 | Single input X113:3 | |
| | DI X113:4 | Single input X113:4 | |
| | DI X114:1 | Single input X114:1 | |
| | DI X114:2 | Single input X114:2 | |
| | DI X114:3 | Single input X114:3 | |
| | DI X114:4 | Single input X114:4 | |

| Index | Name/Value | Description | Factory default |
|---------|--------------------------|--|-----------------|
| SLSx.12 | SLS1 input B | Sets the secondary digital input for the SLS1 function. The secondary input is mostly used for cascade connection (only SLS1 can be cascaded).
See parameters SAFEIO.12 Cascade A and SAFEIO.13 Cascade B . | <i>None</i> |
| | None | No input connected | |
| | DI X113:1 & X114:1 | Redundant input X113:1 & X114:1 | |
| | DI X113:2 & X114:2 | Redundant input X113:2 & X114:2 | |
| | DI X113:3 & X114:3 | Redundant input X113:3 & X114:3 | |
| | DI X113:4 & X114:4 | Redundant input X113:4 & X114:4 | |
| | DI X113:1 | Single input X113:1 | |
| | DI X113:2 | Single input X113:2 | |
| | DI X113:3 | Single input X113:3 | |
| | DI X113:4 | Single input X113:4 | |
| | DI X114:1 | Single input X114:1 | |
| | DI X114:2 | Single input X114:2 | |
| | DI X114:3 | Single input X114:3 | |
| | DI X114:4 | Single input X114:4 | |
| SLSx.13 | SLS1 trip limit negative | Sets the SLS1 negative speed limit that trips the drive. | 0.0 rpm |
| | -35880.0 ...0.0 rpm | Speed | |
| SLSx.14 | SLS1 trip limit positive | Sets the SLS1 positive speed limit that trips the drive. | 0.0 rpm |
| | 0.0...35880.0 rpm | Speed | |
| SLSx.15 | SLS1 output A | Sets the primary digital output for the SLS1 function. Active when SLS1 function is active and the motor speed is below the SLS1 limit (that is, when the SLS1 monitoring is on). | <i>None</i> |
| | None | No output connected | |
| | DO X113:7 & X114:7 | Redundant output X113:7 & X114:7 | |
| | DO X113:8 & X114:8 | Redundant output X113:8 & X114:8 | |
| | DO X113:9 & X114:9 | Redundant output X113:9 & X114:9 | |
| | DO X113:7 | Single output X113:7 | |
| | DO X113:8 | Single output X113:8 | |
| | DO X113:9 | Single output X113:9 | |
| | DO X114:7 | Single output X114:7 | |
| | DO X114:8 | Single output X114:8 | |
| | DO X114:9 | Single output X114:9 | |

| Index | Name/Value | Description | Factory default |
|---------|--------------------------|--|-----------------|
| SLSx.16 | SLS1 output B | Sets the secondary digital output for the SLS1 function. Active when SLS1 function is active and the motor speed is below the SLS1 limit (that is, when the SLS1 monitoring is on).
The secondary output is mostly used for cascade connection.
See parameters SAFEIO.12 Cascade A and SAFEIO.13 Cascade B . | <i>None</i> |
| | None | No output connected | |
| | DO X113:7 & X114:7 | Redundant output X113:7 & X114:7 | |
| | DO X113:8 & X114:8 | Redundant output X113:8 & X114:8 | |
| | DO X113:9 & X114:9 | Redundant output X113:9 & X114:9 | |
| | DO X113:7 | Single output X113:7 | |
| | DO X113:8 | Single output X113:8 | |
| | DO X113:9 | Single output X113:9 | |
| | DO X114:7 | Single output X114:7 | |
| | DO X114:8 | Single output X114:8 | |
| | DO X114:9 | Single output X114:9 | |
| SLSx.17 | Mute time for SLS1 | Sets the SLS1 specific mute time for limit hit situations.
This parameter is effective only with the safe speed estimate. | 0 ms |
| | 0...10000 ms | | |
| SLSx.21 | SLS2 input | Sets the digital input for the SLS2 function. | <i>None</i> |
| | None | No input connected | |
| | DI X113:1 & X114:1 | Redundant input X113:1 & X114:1 | |
| | DI X113:2 & X114:2 | Redundant input X113:2 & X114:2 | |
| | DI X113:3 & X114:3 | Redundant input X113:3 & X114:3 | |
| | DI X113:4 & X114:4 | Redundant input X113:4 & X114:4 | |
| | DI X113:1 | Single input X113:1 | |
| | DI X113:2 | Single input X113:2 | |
| | DI X113:3 | Single input X113:3 | |
| | DI X113:4 | Single input X113:4 | |
| | DI X114:1 | Single input X114:1 | |
| | DI X114:2 | Single input X114:2 | |
| | DI X114:3 | Single input X114:3 | |
| | DI X114:4 | Single input X114:4 | |
| SLSx.22 | SLS2 trip limit negative | Sets the SLS2 negative speed limit that trips the drive. | 0.0 rpm |
| | -35880.0 ...0.0 rpm | Speed | |

| Index | Name/Value | Description | Factory default |
|---------|--------------------------|---|-----------------|
| SLSx.23 | SLS2 trip limit positive | Sets the SLS2 positive speed limit that trips the drive. | 0.0 rpm |
| | 0.0...35880.0 rpm | Speed | |
| SLSx.24 | SLS2 output | Sets the digital output for SLS2 function. Active when SLS2 function is active and the motor speed is below the SLS2 limit (that is, when the SLS2 monitoring is on). | <i>None</i> |
| | None | No output connected | |
| | DO X113:7 & X114:7 | Redundant output X113:7 & X114:7 | |
| | DO X113:8 & X114:8 | Redundant output X113:8 & X114:8 | |
| | DO X113:9 & X114:9 | Redundant output X113:9 & X114:9 | |
| | DO X113:7 | Single output X113:7 | |
| | DO X113:8 | Single output X113:8 | |
| | DO X113:9 | Single output X113:9 | |
| | DO X114:7 | Single output X114:7 | |
| | DO X114:8 | Single output X114:8 | |
| | DO X114:9 | Single output X114:9 | |
| SLSx.27 | Mute time for SLS2 | Sets the SLS2 specific mute time for limit hit situations. This parameter is effective only with the safe speed estimate. | 0 ms |
| | 0...10000 ms | | |
| SLSx.31 | SLS3 input | Sets the digital input for the SLS3 function. | <i>None</i> |
| | None | No input connected | |
| | DI X113:1 & X114:1 | Redundant input X113:1 & X114:1 | |
| | DI X113:2 & X114:2 | Redundant input X113:2 & X114:2 | |
| | DI X113:3 & X114:3 | Redundant input X113:3 & X114:3 | |
| | DI X113:4 & X114:4 | Redundant input X113:4 & X114:4 | |
| | DI X113:1 | Single input X113:1 | |
| | DI X113:2 | Single input X113:2 | |
| | DI X113:3 | Single input X113:3 | |
| | DI X113:4 | Single input X113:4 | |
| | DI X114:1 | Single input X114:1 | |
| | DI X114:2 | Single input X114:2 | |
| | DI X114:3 | Single input X114:3 | |
| | DI X114:4 | Single input X114:4 | |
| SLSx.32 | SLS3 trip limit negative | SLS3 negative speed limit that trips the drive. | 0.0 rpm |
| | -35880.0 ...0.0 rpm | Speed | |
| SLSx.33 | SLS3 trip limit positive | Sets the SLS3 positive speed limit that trips the drive. | 0.0 rpm |
| | 0.0...35880.0 rpm | Speed | |

| Index | Name/Value | Description | Factory default |
|---------|--------------------------|---|-----------------|
| SLSx.34 | SLS3 output | Sets the digital output for the SLS3 function. Active when SLS3 function is active and the motor speed is below the SLS3 limit (that is, when the SLS3 monitoring is on). | <i>None</i> |
| | None | No output connected | |
| | DO X113:7 & X114:7 | Redundant output X113:7 & X114:7 | |
| | DO X113:8 & X114:8 | Redundant output X113:8 & X114:8 | |
| | DO X113:9 & X114:9 | Redundant output X113:9 & X114:9 | |
| | DO X113:7 | Single output X113:7 | |
| | DO X113:8 | Single output X113:8 | |
| | DO X113:9 | Single output X113:9 | |
| | DO X114:7 | Single output X114:7 | |
| | DO X114:8 | Single output X114:8 | |
| | DO X114:9 | Single output X114:9 | |
| SLSx.37 | Mute time for SLS3 | Sets the SLS3 specific mute time for limit hit situations.
This parameter is effective only with the safe speed estimate. | 0 ms |
| | 0...10000 ms | | |
| SLSx.41 | SLS4 input | Sets the digital input for the SLS4 function. | <i>None</i> |
| | None | No input connected | |
| | DI X113:1 & X114:1 | Redundant input X113:1 & X114:1 | |
| | DI X113:2 & X114:2 | Redundant input X113:2 & X114:2 | |
| | DI X113:3 & X114:3 | Redundant input X113:3 & X114:3 | |
| | DI X113:4 & X114:4 | Redundant input X113:4 & X114:4 | |
| | DI X113:1 | Single input X113:1 | |
| | DI X113:2 | Single input X113:2 | |
| | DI X113:3 | Single input X113:3 | |
| | DI X113:4 | Single input X113:4 | |
| | DI X114:1 | Single input X114:1 | |
| | DI X114:2 | Single input X114:2 | |
| | DI X114:3 | Single input X114:3 | |
| | DI X114:4 | Single input X114:4 | |
| SLSx.42 | SLS4 trip limit negative | Sets the SLS4 negative speed limit that trips the drive.
Note: Variable SLS uses this limit as scaled. See Defining the scaled SLS4 limit and SLS4 trip limits on page 372. | 0.0 rpm |
| | -35880.0 ...0.0 rpm | Speed | |

| Index | Name/Value | Description | Factory default |
|---------|--------------------------|---|-----------------|
| SLSx.43 | SLS4 trip limit positive | Sets the SLS4 positive speed limit that trips the drive.
Note: Variable SLS uses this limit as scaled. See Defining the scaled SLS4 limit and SLS4 trip limits on page 372. | 0.0 rpm |
| | 0.0...35880.0 rpm | Speed | |
| SLSx.44 | SLS4 output | Sets the digital output for the SLS4 function. Active when SLS4 function is active and the motor speed is below the SLS4 limit (that is, when the SLS4 monitoring is on). | <i>None</i> |
| | None | No output connected | |
| | DO X113:7 & X114:7 | Redundant output X113:7 & X114:7 | |
| | DO X113:8 & X114:8 | Redundant output X113:8 & X114:8 | |
| | DO X113:9 & X114:9 | Redundant output X113:9 & X114:9 | |
| | DO X113:7 | Single output X113:7 | |
| | DO X113:8 | Single output X113:8 | |
| | DO X113:9 | Single output X113:9 | |
| | DO X114:7 | Single output X114:7 | |
| | DO X114:8 | Single output X114:8 | |
| | DO X114:9 | Single output X114:9 | |
| SLSx.47 | Mute time for SLS4 | Sets the SLS4 specific mute time for limit hit situations.
This parameter is effective only with the safe speed estimate. | 0 ms |
| | 0...10000 ms | | |
| SLSx.51 | Variable SLS output | Sets the digital output for the Variable SLS function. Active when Variable SLS function is active and the motor speed is below the Variable SLS limit (that is, when the Variable SLS monitoring is on). | <i>None</i> |
| | None | No output connected | |
| | DO X113:7 & X114:7 | Redundant output X113:7 & X114:7 | |
| | DO X113:8 & X114:8 | Redundant output X113:8 & X114:8 | |
| | DO X113:9 & X114:9 | Redundant output X113:9 & X114:9 | |
| | DO X113:7 | Single output X113:7 | |
| | DO X113:8 | Single output X113:8 | |
| | DO X113:9 | Single output X113:9 | |
| | DO X114:7 | Single output X114:7 | |
| | DO X114:8 | Single output X114:8 | |
| | DO X114:9 | Single output X114:9 | |

| Index | Name/Value | Description | Factory default |
|--|----------------------------|---|-----------------|
| SLSx.57 | Mute time for variable SLS | Sets the variable SLS specific mute time for limit hit situations.
This parameter is effective only with the safe speed estimate. | 0 ms |
| | 0...10000 ms | | |
| SMS | | | |
| Parameters for the SMS function | | | |
| SMS.13 | SMS trip limit negative | Sets the negative speed limit that trips the drive for the SMS function. | 0.0 rpm |
| | -35880.0 ...0.0 rpm | Speed | |
| SMS.14 | SMS trip limit positive | Sets the positive speed limit that trips the drive for the SMS function. | 0.0 rpm |
| | 0.0 ...35880.0 rpm | Speed | |
| SMS.17 | Mute time for SMS | Sets the SMS specific mute time for limit hit situations.
This parameter is effective only with the safe speed estimate. | 0 ms |
| | 0...5000 ms | | |
| SARx | | | |
| Parameters for SARx ramps | | | |
| SARx.02 | SAR initial allowed range | Sets the initial allowed range for the SARx ramp. This parameter moves the location of the maximum monitoring ramp forward on the time axis, when monitoring is started. The slope of the ramp stays the same as defined with parameters 200.202 and SARx.12 (SAR0) or SARx.22 (SAR1).
For more information, see section Ramp monitoring on page 57. | 0 ms |
| | 0...60,000 ms | Time | |
| SARx.11 | SAR0 min ramp time to zero | Sets the minimum ramp time for the SAR0 ramp monitoring. | 0 ms |
| | 0...1,799,999 ms | Time.
Note: With value <i>0 ms</i> , the ramp is not monitored | |
| SARx.12 | SAR0 max ramp time to zero | Sets the maximum ramp time for the SAR0 ramp monitoring. | 1 ms |
| | 1...3,600,000 ms | Time | |
| SARx.21 | SAR1 min ramp time to zero | Sets the minimum ramp time for the SAR1 ramp monitoring. | 0 ms |
| | 0...1,799,999 ms | Time
Note: With value <i>0 ms</i> , the ramp is not monitored | |

| Index | Name/Value | Description | Factory default |
|------------|----------------------------------|--|-----------------|
| SARx.22 | SAR1 max ramp time to zero | Sets the maximum ramp time for the SAR1 ramp monitoring. | 1 ms |
| | 1...3,600,000 ms | Time | |
| SDI | | Parameters for the SDI functions | |
| SDI.01 | SDI version | Shows the version of the SDI functions (SDI positive and SDI negative). | <i>Disabled</i> |
| | Disabled | Deactivates the SDI functions. | |
| | Version 1 | Version 1. | |
| SDI.02 | SDI positive activity | Activates or deactivates the SDI positive function. | <i>Disabled</i> |
| | Disabled | Deactivates the SDI positive function. | |
| | Enabled | Activates the SDI positive function. | |
| SDI.03 | SDI negative activity | Activates or deactivates the SDI negative function. | <i>Disabled</i> |
| | Disabled | Deactivates the SDI negative function. | |
| | Enabled | Activates the SDI negative function. | |
| SDI.10 | SDI activation monitoring method | Sets the monitoring method that is used in SDI activation. | <i>Ramp</i> |
| | Ramp | Ramp monitoring. SAR1 parameters define the deceleration ramp and monitoring limits. See parameters 200.112 , SARx.21 , SARx.22 and SARx.02 . | |
| | Time | Time monitoring. The drive (parameter 23.13 or 23.15) defines the deceleration ramp and it is monitored with parameter SDI.12 SDI delay . | |
| SDI.12 | SDI delay | Sets the delay for starting SDI monitoring. This parameter is relevant only when parameter SDI.10 SDI activation monitoring method is set to <i>Time</i> . | 0 ms |
| | 0...3,600,000 ms | Time | |
| SDI.13 | SDI acknowledgement | Sets the acknowledgement method used in the SDI function. | <i>Manual</i> |
| | Manual | The FSO module reads the external SDI acknowledgement signal through the digital input defined by parameter FSOGEN.42 Acknowledgement button input . The correct rotation direction must be achieved before acknowledgement is accepted. | |
| | Automatic | The FSO module generates the SDI acknowledgement signal automatically after the SDI request has been removed and the correct rotation direction has been achieved. | |

| Index | Name/Value | Description | Factory default |
|--------|-----------------------------|--|-----------------|
| | Safebus | The FSO module expects an external SDI acknowledgement signal from the safety fieldbus after the SDI request has been removed and the correct rotation direction has been achieved. | |
| | Manual_Safebus | The FSO module expects an external SDI acknowledgement signal either from a digital input or from the safety fieldbus after the SDI request has been removed and the correct rotation direction has been achieved. | |
| SDI.14 | SDI tolerance limit degree | Sets the position tolerance for the SDI function. The position of the motor shaft cannot move into the forbidden direction more than defined with this parameter.
Note: This is the absolute value. The same value is used in both positive and negative directions. | 0.00 deg |
| | 0.00...
3,600,000.00 deg | Degree | |
| SDI.21 | SDI positive input A | Sets the digital input connected to the SDI primary input for positive rotation. | <i>None</i> |
| | None | No input connected | |
| | DI X113:1 & X114:1 | Redundant input X113:1 & X114:1 | |
| | DI X113:2 & X114:2 | Redundant input X113:2 & X114:2 | |
| | DI X113:3 & X114:3 | Redundant input X113:3 & X114:3 | |
| | DI X113:4 & X114:4 | Redundant input X113:4 & X114:4 | |
| | DI X113:1 | Single input X113:1 | |
| | DI X113:2 | Single input X113:2 | |
| | DI X113:3 | Single input X113:3 | |
| | DI X113:4 | Single input X113:4 | |
| | DI X114:1 | Single input X114:1 | |
| | DI X114:2 | Single input X114:2 | |
| | DI X114:3 | Single input X114:3 | |
| | DI X114:4 | Single input X114:4 | |
| | Always on | The SDI positive function is always on. | |
| SDI.22 | SDI positive input B | Sets the digital input connected to the SDI secondary input for positive rotation. The secondary output is mostly used for cascade connection. See parameters SAFEIO.12 Cascade A and SAFEIO.13 Cascade B . | <i>None</i> |
| | None | No input connected | |
| | DI X113:1 & X114:1 | Redundant input X113:1 & X114:1 | |
| | DI X113:2 & X114:2 | Redundant input X113:2 & X114:2 | |

| Index | Name/Value | Description | Factory default |
|--------|-----------------------|--|-----------------|
| | DI X113:3 & X114:3 | Redundant input X113:3 & X114:3 | |
| | DI X113:4 & X114:4 | Redundant input X113:4 & X114:4 | |
| | DI X113:1 | Single input X113:1 | |
| | DI X113:2 | Single input X113:2 | |
| | DI X113:3 | Single input X113:3 | |
| | DI X113:4 | Single input X113:4 | |
| | DI X114:1 | Single input X114:1 | |
| | DI X114:2 | Single input X114:2 | |
| | DI X114:3 | Single input X114:3 | |
| | DI X114:4 | Single input X114:4 | |
| | Always on | The SDI positive function is always on. | |
| SDI.23 | SDI positive output A | Sets the digital output connected to the SDI positive primary output. Active when the motor rotates in the correct (positive) direction. | <i>None</i> |
| | None | No output connected | |
| | DO X113:7 & X114:7 | Redundant output X113:7 & X114:7 | |
| | DO X113:8 & X114:8 | Redundant output X113:8 & X114:8 | |
| | DO X113:9 & X114:9 | Redundant output X113:9 & X114:9 | |
| | DO X113:7 | Single output X113:7 | |
| | DO X113:8 | Single output X113:8 | |
| | DO X113:9 | Single output X113:9 | |
| | DO X114:7 | Single output X114:7 | |
| | DO X114:8 | Single output X114:8 | |
| | DO X114:9 | Single output X114:9 | |
| SDI.24 | SDI positive output B | Sets the digital output that is connected to the secondary output of the SDI positive function. Active when the motor rotates in the correct (positive) direction.

The secondary output is mostly used for cascade connection. See parameters SAFEIO.12 Cascade A and SAFEIO.13 Cascade B . | <i>None</i> |
| | None | No output connected | |
| | DO X113:7 & X114:7 | Redundant output X113:7 & X114:7 | |
| | DO X113:8 & X114:8 | Redundant output X113:8 & X114:8 | |
| | DO X113:9 & X114:9 | Redundant output X113:9 & X114:9 | |
| | DO X113:7 | Single output X113:7 | |
| | DO X113:8 | Single output X113:8 | |
| | DO X113:9 | Single output X113:9 | |
| | DO X114:7 | Single output X114:7 | |
| | DO X114:8 | Single output X114:8 | |

| Index | Name/Value | Description | Factory default |
|--------|-----------------------|--|-----------------|
| | DO X114:9 | Single output X114:9 | |
| SDI.31 | SDI negative input A | Sets the digital input connected to the SDI primary input for negative rotation. | <i>None</i> |
| | None | No input connected | |
| | DI X113:1 & X114:1 | Redundant input X113:1 & X114:1 | |
| | DI X113:2 & X114:2 | Redundant input X113:2 & X114:2 | |
| | DI X113:3 & X114:3 | Redundant input X113:3 & X114:3 | |
| | DI X113:4 & X114:4 | Redundant input X113:4 & X114:4 | |
| | DI X113:1 | Single input X113:1 | |
| | DI X113:2 | Single input X113:2 | |
| | DI X113:3 | Single input X113:3 | |
| | DI X113:4 | Single input X113:4 | |
| | DI X114:1 | Single input X114:1 | |
| | DI X114:2 | Single input X114:2 | |
| | DI X114:3 | Single input X114:3 | |
| | DI X114:4 | Single input X114:4 | |
| | Always on | The SDI negative function is always on. | |
| SDI.32 | SDI negative input B | Sets the digital input connected to the SDI secondary input for negative rotation.
The secondary output is mostly used for cascade connection. See parameters SAFEIO.12 Cascade A and SAFEIO.13 Cascade B . | <i>None</i> |
| | None | No input connected | |
| | DI X113:1 & X114:1 | Redundant input X113:1 & X114:1 | |
| | DI X113:2 & X114:2 | Redundant input X113:2 & X114:2 | |
| | DI X113:3 & X114:3 | Redundant input X113:3 & X114:3 | |
| | DI X113:4 & X114:4 | Redundant input X113:4 & X114:4 | |
| | DI X113:1 | Single input X113:1 | |
| | DI X113:2 | Single input X113:2 | |
| | DI X113:3 | Single input X113:3 | |
| | DI X113:4 | Single input X113:4 | |
| | DI X114:1 | Single input X114:1 | |
| | DI X114:2 | Single input X114:2 | |
| | DI X114:3 | Single input X114:3 | |
| | DI X114:4 | Single input X114:4 | |
| | Always on | The SDI negative function is always on. | |
| SDI.33 | SDI negative output A | Sets the digital output connected to the SDI negative primary output. Active when the motor rotates in the correct (negative) direction. | <i>None</i> |
| | None | No output connected | |

| Index | Name/Value | Description | Factory default |
|--------|-----------------------|--|-----------------|
| | DO X113:7 & X114:7 | Redundant output X113:7 & X114:7 | |
| | DO X113:8 & X114:8 | Redundant output X113:8 & X114:8 | |
| | DO X113:9 & X114:9 | Redundant output X113:9 & X114:9 | |
| | DO X113:7 | Single output X113:7 | |
| | DO X113:8 | Single output X113:8 | |
| | DO X113:9 | Single output X113:9 | |
| | DO X114:7 | Single output X114:7 | |
| | DO X114:8 | Single output X114:8 | |
| | DO X114:9 | Single output X114:9 | |
| SDI.34 | SDI negative output B | Sets the digital output that is connected to the secondary output of the SDI negative function. Active when the motor rotates in the correct (negative) direction.

The secondary output is mostly used for cascade connection. See parameters SAFEIO.12 Cascade A and SAFEIO.13 Cascade B . | <i>None</i> |
| | None | No output connected | |
| | DO X113:7 & X114:7 | Redundant output X113:7 & X114:7 | |
| | DO X113:8 & X114:8 | Redundant output X113:8 & X114:8 | |
| | DO X113:9 & X114:9 | Redundant output X113:9 & X114:9 | |
| | DO X113:7 | Single output X113:7 | |
| | DO X113:8 | Single output X113:8 | |
| | DO X113:9 | Single output X113:9 | |
| | DO X114:7 | Single output X114:7 | |
| | DO X114:8 | Single output X114:8 | |
| | DO X114:9 | Single output X114:9 | |

| SSMx | Parameters for the SSM1...4 functions | | |
|---------|---------------------------------------|--|-----------------|
| SSMx.01 | SSM1 activity and version | Activates or deactivates the SSM1 function and shows the version of the SSM1 function. | <i>Disabled</i> |
| | Disabled | Deactivates the SSM1 function. | |
| | Version 1 | Activates version 1 of the SSM1 function. | |
| SSMx.02 | SSM2 activity and version | Activates or deactivates the SSM2 function and shows the version of the SSM2 function. | <i>Disabled</i> |
| | Disabled | Deactivates the SSM2 function. | |
| | Version 1 | Activates version 1 of the SSM2 function. | |
| SSMx.03 | SSM3 activity and version | Activates or deactivates the SSM3 function and shows the version of the SSM3 function. | <i>Disabled</i> |
| | Disabled | Deactivates the SSM3 function. | |
| | Version 1 | Activates version 1 of the SSM3 function. | |

| Index | Name/Value | Description | Factory default |
|-----------|---------------------------|--|-----------------|
| SSMx.04 | SSM4 activity and version | Activates or deactivates the SSM4 function and shows the version of the SSM4 function. | <i>Disabled</i> |
| | Disabled | Deactivates the SSM4 function. | |
| | Version 1 | Activates version 1 of the SSM4 function. | |
| SSMx.11 | SSM1 input | Sets the digital input connected to the SSM1 function. | <i>None</i> |
| | None | No input connected | |
| | DI X113:1 & X114:1 | Redundant input X113:1 & X114:1 | |
| | DI X113:2 & X114:2 | Redundant input X113:2 & X114:2 | |
| | DI X113:3 & X114:3 | Redundant input X113:3 & X114:3 | |
| | DI X113:4 & X114:4 | Redundant input X113:4 & X114:4 | |
| | DI X113:1 | Single input X113:1 | |
| | DI X113:2 | Single input X113:2 | |
| | DI X113:3 | Single input X113:3 | |
| | DI X113:4 | Single input X113:4 | |
| | DI X114:1 | Single input X114:1 | |
| | DI X114:2 | Single input X114:2 | |
| | DI X114:3 | Single input X114:3 | |
| | DI X114:4 | Single input X114:4 | |
| | Always on | The SSM1 function is always on. | |
| SSMx.12 | SSM1 limit negative | Sets the negative speed limit for the SSM1 function. | 0.0 rpm |
| | -35880.0 ...0.0 rpm | Speed | |
| SSMx.13 | SSM1 limit positive | Sets the positive speed limit for the SSM1 function. | 0.0 rpm |
| | 0.0...35880.0 rpm | Speed | |
| SSMx.14 | SSM1 output | Sets the digital output connected to the SSM1 function. Active when the motor speed is within the SSM1 speed limits. | <i>None</i> |
| | None | No output connected | |
| | DO X113:7 & X114:7 | Redundant output X113:7 & X114:7 | |
| | DO X113:8 & X114:8 | Redundant output X113:8 & X114:8 | |
| | DO X113:9 & X114:9 | Redundant output X113:9 & X114:9 | |
| | DO X113:7 | Single output X113:7 | |
| | DO X113:8 | Single output X113:8 | |
| | DO X113:9 | Single output X113:9 | |
| | DO X114:7 | Single output X114:7 | |
| | DO X114:8 | Single output X114:8 | |
| DO X114:9 | Single output X114:9 | | |
| SSMx.21 | SSM2 input | Sets the digital input connected to the SSM2 function. | <i>None</i> |

| Index | Name/Value | Description | Factory default |
|---------|---------------------|--|-----------------|
| | None | No input connected | |
| | DI X113:1 & X114:1 | Redundant input X113:1 & X114:1 | |
| | DI X113:2 & X114:2 | Redundant input X113:2 & X114:2 | |
| | DI X113:3 & X114:3 | Redundant input X113:3 & X114:3 | |
| | DI X113:4 & X114:4 | Redundant input X113:4 & X114:4 | |
| | DI X113:1 | Single input X113:1 | |
| | DI X113:2 | Single input X113:2 | |
| | DI X113:3 | Single input X113:3 | |
| | DI X113:4 | Single input X113:4 | |
| | DI X114:1 | Single input X114:1 | |
| | DI X114:2 | Single input X114:2 | |
| | DI X114:3 | Single input X114:3 | |
| | DI X114:4 | Single input X114:4 | |
| | Always on | The SSM2 function is always on. | |
| SSMx.22 | SSM2 limit negative | Sets the negative speed limit for the SSM2 function. | 0.0 rpm |
| | -35880.0 ...0.0 rpm | Speed | |
| SSMx.23 | SSM2 limit positive | Sets the positive speed limit for the SSM2 function. | 0.0 rpm |
| | 0.0...35880.0 rpm | Speed | |
| SSMx.24 | SSM2 output | Sets the digital output connected to the SSM2 function. Active when the motor speed is within the SSM2 speed limits. | None |
| | None | No output connected | |
| | DO X113:7 & X114:7 | Redundant output X113:7 & X114:7 | |
| | DO X113:8 & X114:8 | Redundant output X113:8 & X114:8 | |
| | DO X113:9 & X114:9 | Redundant output X113:9 & X114:9 | |
| | DO X113:7 | Single output X113:7 | |
| | DO X113:8 | Single output X113:8 | |
| | DO X113:9 | Single output X113:9 | |
| | DO X114:7 | Single output X114:7 | |
| | DO X114:8 | Single output X114:8 | |
| | DO X114:9 | Single output X114:9 | |
| SSMx.31 | SSM3 input | Sets the digital input connected to the SSM3 function. | None |
| | None | No input connected | |
| | DI X113:1 & X114:1 | Redundant input X113:1 & X114:1 | |
| | DI X113:2 & X114:2 | Redundant input X113:2 & X114:2 | |
| | DI X113:3 & X114:3 | Redundant input X113:3 & X114:3 | |
| | DI X113:4 & X114:4 | Redundant input X113:4 & X114:4 | |
| | DI X113:1 | Single input X113:1 | |

| Index | Name/Value | Description | Factory default |
|---------|---------------------|--|-----------------|
| | DI X113:2 | Single input X113:2 | |
| | DI X113:3 | Single input X113:3 | |
| | DI X113:4 | Single input X113:4 | |
| | DI X114:1 | Single input X114:1 | |
| | DI X114:2 | Single input X114:2 | |
| | DI X114:3 | Single input X114:3 | |
| | DI X114:4 | Single input X114:4 | |
| | Always on | The SSM3 function is always on. | |
| SSMx.32 | SSM3 limit negative | Sets the negative speed limit for the SSM3 function. | 0.0 rpm |
| | -35880.0 ...0.0 rpm | Speed | |
| SSMx.33 | SSM3 limit positive | Sets the positive speed limit for the SSM3 function. | 0.0 rpm |
| | 0.0...35880.0 rpm | Speed | |
| SSMx.34 | SSM3 output | Sets the digital output connected to the SSM3 function. Active when the motor speed is within the SSM3 speed limits. | <i>None</i> |
| | None | No output connected | |
| | DO X113:7 & X114:7 | Redundant output X113:7 & X114:7 | |
| | DO X113:8 & X114:8 | Redundant output X113:8 & X114:8 | |
| | DO X113:9 & X114:9 | Redundant output X113:9 & X114:9 | |
| | DO X113:7 | Single output X113:7 | |
| | DO X113:8 | Single output X113:8 | |
| | DO X113:9 | Single output X113:9 | |
| | DO X114:7 | Single output X114:7 | |
| | DO X114:8 | Single output X114:8 | |
| | DO X114:9 | Single output X114:9 | |
| SSMx.41 | SSM4 input | Sets the digital input connected to the SSM4 function. | <i>None</i> |
| | None | No input connected | |
| | DI X113:1 & X114:1 | Redundant input X113:1 & X114:1 | |
| | DI X113:2 & X114:2 | Redundant input X113:2 & X114:2 | |
| | DI X113:3 & X114:3 | Redundant input X113:3 & X114:3 | |
| | DI X113:4 & X114:4 | Redundant input X113:4 & X114:4 | |
| | DI X113:1 | Single input X113:1 | |
| | DI X113:2 | Single input X113:2 | |
| | DI X113:3 | Single input X113:3 | |
| | DI X113:4 | Single input X113:4 | |
| | DI X114:1 | Single input X114:1 | |
| | DI X114:2 | Single input X114:2 | |
| | DI X114:3 | Single input X114:3 | |

| Index | Name/Value | Description | Factory default |
|---------|---------------------|--|-----------------|
| | DI X114:4 | Single input X114:4 | |
| | Always on | The SSM4 function is always on. | |
| SSMx.42 | SSM4 limit negative | Sets the negative speed limit for the SSM4 function. | 0.0 rpm |
| | -35880.0 ...0.0 rpm | Speed | |
| SSMx.43 | SSM4 limit positive | Sets the positive speed limit for the SSM4 function. | 0.0 rpm |
| | 0.0...35880.0 rpm | Speed | |
| SSMx.44 | SSM4 output | Sets the digital output connected to the SSM4 function. Active when the motor speed is within the SSM4 speed limits. | <i>None</i> |
| | None | No output connected | |
| | DO X113:7 & X114:7 | Redundant output X113:7 & X114:7 | |
| | DO X113:8 & X114:8 | Redundant output X113:8 & X114:8 | |
| | DO X113:9 & X114:9 | Redundant output X113:9 & X114:9 | |
| | DO X113:7 | Single output X113:7 | |
| | DO X113:8 | Single output X113:8 | |
| | DO X113:9 | Single output X113:9 | |
| | DO X114:7 | Single output X114:7 | |
| | DO X114:8 | Single output X114:8 | |
| | DO X114:9 | Single output X114:9 | |

| S_ENCGEN | | General parameters for safety pulse encoders | |
|-----------------|---------------------------------------|---|-----------------|
| S_ENCGEN. | Safe pulse encoder
01 version | Activates or deactivates the safety encoder and shows the version of parameter group S_ENCGEN and parameters FSOGEN.52 and SBC.14 . | <i>Disabled</i> |
| | Disabled | Deactivates the safety pulse encoder. | |
| | Version 1 | Activates the safety pulse encoder. | |
| S_ENCGEN. | FSE diagnostic
11 failure reaction | Sets the action taken when there is a problem with the FSE module or the safety encoder. | <i>STO</i> |
| | STO | The FSO module goes into the Fail-safe mode and activates the drive STO function. | |
| | No STO | If there are no active safety functions, the FSO module sends a warning to the drive. If there are active safety functions, the FSO module goes into the Fail-safe mode. | |

| Index | Name/Value | Description | Factory default |
|-----------|-----------------------------------|---|-----------------|
| | Est switch not active load | <p>With some restrictions, the FSO module sends a warning to the drive and starts to use an estimated value of the motor speed until the failure is fixed.</p> <p>For more information, see section Motor speed feedback on page 44.</p> <p>Note: Do not use this selection in applications with active load. See section Safe speed estimate on page 44.</p> <p>Note: Safe speed estimate cannot be used with a DCS880 drive.</p> | |
| S_ENCGEN. | Enc speed cross 14 comp tolerance | <p>Sets the encoder speed cross comparison tolerance. This defines how much the motor shaft speed can change within 1 ms. If the tolerance is exceeded, the FSO module reaction depends on the S_ENCGEN.11 selection.</p> <p>Note: This parameter is used for the encoder diagnostic. It defines how large the difference between the speed information from channel A and B of the encoder can be. If the difference between these two values is greater than the value set to this parameter, FSO will safely stop the system (STO).</p> <p>The suitable value depends on the configuration (motor / load). Typically this value is set to 2-10 rpm; a very low value will cause an encoder fault (A7D8) whereas too high a value will prevent encoder diagnostic related to this parameter.</p> | 0.0 rpm |
| | 0.0 ...500.0 rpm | Speed | |
| S_ENCGEN. | Gear numerator 41 encoder 1 | Sets the rotation direction for the safety encoder. With this parameter, you can change the rotation direction of the motor. | 1 |
| | 1 | Positive direction. | |
| | -1 | Negative direction. | |

| Enc module settings | | Parameters for the safety encoder interface module | |
|---------------------|---------------|--|-------------|
| 91.11 | Module 1 type | Sets the type of the safety encoder interface module 1. | <i>None</i> |
| | None | The safety encoder interface module is not in use. | |
| | FSE-31 | The type of the safety encoder interface module is FSE-31. | |

| Index | Name/Value | Description | Factory default |
|-------|-------------------|--|-----------------|
| 91.12 | Module 1 location | Sets the slot in which the safety encoder interface module is located. | 2 |
| | 1 | Slot 1 on the drive control board. | |
| | 2 | Slot 2 on the drive control board. | |
| | 3 | Slot 3 on the drive control board. | |

| Encoder 1 configuration | | Parameters for safety encoder 1 | |
|-------------------------|----------------------------------|---|----------|
| 92.01 | Encoder 1 type | Activates the communication with the safety encoder interface module 1 and sets the type for the safety encoder. | HTL1 |
| | HTL1 | Communication active.
Module type: FSE-31.
Input: HTL encoder input (X31). | |
| 92.02 | Encoder 1 source | Sets the safety encoder interface module that the safety encoder 1 is connected to. | Module 1 |
| | Module 1 | The safety encoder 1 is connected to interface module 1. | |
| 92.10 | Pulses/revolution | Sets the number of HTL pulses per revolution for safety encoder 1. | 0 |
| | 0...65535 | Pulse rate of the encoder used | |
| 92.17 | Accepted pulse freq of encoder 1 | Sets the maximum pulse frequency of encoder 1 (see Configuring the safety encoder interface on page 315).
If the measured pulse frequency of the safety encoder is higher than the value set here, the FSO module reaction depends on the S_ENCGEN.11 selection. | 0.0 kHz |
| | 0...300 kHz | Frequency | |

| SAFEIO | | Parameters for FSO inputs and outputs | |
|-----------|-------------------------------|--|-------------------------------|
| SAFEIO.11 | M/F mode for cascade | Sets the master/follower mode of the FSO module for both cascade connections A and B separately. | A = follower,
B = follower |
| | A = follower,
B = follower | The module is a follower on cascade connection A and a follower on cascade connection B. | |
| | A = master,
B = follower | The module is the master on cascade connection A and a follower on cascade connection B. | |
| | A = follower,
B = master | The module is a follower on cascade connection A and the master on cascade connection B. | |
| | A = master,
B = master | The module is the master on cascade connection A and the master on cascade connection B. | |

| Index | Name/Value | Description | Factory default |
|-----------|---------------------------------------|---|-----------------|
| SAFEIO.12 | Cascade A | Sets the cascade connection A for the FSO module. For each FSO module in cascade A, the digital input connected to the safety function is also internally connected to the corresponding digital output of the FSO module (digital input -> digital output). This resembles a master/follower connection. See section Cascade on page 63. | <i>None</i> |
| | None | Not cascaded | |
| | X113:1 & X114:1 ->
X113:7 & X114:7 | Redundant cascade X113:1 & X114:1 ->
X113:7 & X114:7 | |
| | X113:2 & X114:2 ->
X113:8 & X114:8 | Redundant cascade X113:2 & X114:2 ->
X113:8 & X114:8 | |
| | X113:3 & X114:3 ->
X113:9 & X114:9 | Redundant cascade X113:3 & X114:3 ->
X113:9 & X114:9 | |
| | X113:1 -> X113:7 | Single cascade X113:1 -> X113:7 | |
| | X113:2 -> X113:8 | Single cascade X113:2 -> X113:8 | |
| | X113:3 -> X113:9 | Single cascade X113:3 -> X113:9 | |
| | X114:1 -> X114:7 | Single cascade X114:1 -> X114:7 | |
| | X114:2 -> X114:8 | Single cascade X114:2 -> X114:8 | |
| | X114:3 -> X114:9 | Single cascade X114:3 -> X114:9 | |
| SAFEIO.13 | Cascade B | Sets the cascade connection B for the FSO module. For each FSO module in cascade B, the digital input connected to the safety function is also internally connected to the corresponding digital output of the FSO module (digital input -> digital output). See section Cascade on page 63. | <i>None</i> |
| | None | Not cascaded | |
| | X113:1 & X114:1 ->
X113:7 & X114:7 | Redundant cascade X113:1 & X114:1 ->
X113:7 & X114:7 | |
| | X113:2 & X114:2 ->
X113:8 & X114:8 | Redundant cascade X113:2 & X114:2 ->
X113:8 & X114:8 | |
| | X113:3 & X114:3 ->
X113:9 & X114:9 | Redundant cascade X113:3 & X114:3 ->
X113:9 & X114:9 | |
| | X113:1 -> X113:7 | Single cascade X113:1 -> X113:7 | |
| | X113:2 -> X113:8 | Single cascade X113:2 -> X113:8 | |
| | X113:3 -> X113:9 | Single cascade X113:3 -> X113:9 | |
| | X114:1 -> X114:7 | Single cascade X114:1 -> X114:7 | |
| | X114:2 -> X114:8 | Single cascade X114:2 -> X114:8 | |
| | X114:3 -> X114:9 | Single cascade X114:3 -> X114:9 | |

| Index | Name/Value | Description | Factory default |
|-----------|---------------------------------|---|--|
| SAFEIO.21 | Safety relay 1 output | <p>Sets the digital output connected to the safety relay 1.</p> <p>To connect the safety relay to a certain safety function, you must set the same digital outputs in the output parameter for that safety function. For example, if you set parameter <i>SAFEIO.21 SBC output</i> to the same value as you set for the safety relay output, the safety relay is active when the SBC function is active.</p> <p>Note: The output must always be redundant. Otherwise the feedback signal of the safety relay is not used (see parameter <i>SAFEIO.22 Safety relay 1 feedback</i>).</p> | <i>None</i> |
| | None | No output connected | |
| | DO X113:7 & X114:7 | Redundant output X113:7 & X114:7 | |
| | DO X113:8 & X114:8 | Redundant output X113:8 & X114:8 | |
| | DO X113:9 & X114:9 | Redundant output X113:9 & X114:9 | |
| SAFEIO.22 | Safety relay 1 feedback | <p>Sets the digital feedback input of safety relay 1.</p> <p>Parameter <i>SAFEIO.23 Safety relay 1 feedback type</i> sets the type of the feedback input.</p> | <i>None</i> |
| | None | No input connected | |
| | DI X113:1 | Single input X113:1 | |
| | DI X113:2 | Single input X113:2 | |
| | DI X113:3 | Single input X113:3 | |
| | DI X113:4 | Single input X113:4 | |
| | DI X114:1 | Single input X114:1 | |
| | DI X114:2 | Single input X114:2 | |
| | DI X114:3 | Single input X114:3 | |
| | DI X114:4 | Single input X114:4 | |
| SAFEIO.23 | Safety relay 1 feedback type | <p>Sets the type of the feedback signal for safety relay 1.</p> <p>Note: FSO reads the feedback signal in every state change situation, ie, when STO is activated. The feedback delay is 800 ms for both feedback types, that is, a feedback signal from the safety relay must be received within 800 ms.</p> | <i>Mechanically linked NC contacts</i> |
| | Mechanically linked NC contacts | Feedback of the safety relay is NC (inverted state compared with the relay). | |
| | Mechanically linked NO contacts | Feedback of the safety relay is NO (same state compared with the relay). | |

| Index | Name/Value | Description | Factory default |
|-----------|---------------------------------|--|--|
| SAFEIO.24 | Safety relay 2 output | Sets the digital output for safety relay 2.
See also parameter SAFEIO.21 Safety relay 1 output .
Note: The output must always be redundant. Otherwise the feedback signal of the safety relay is not used (see SAFEIO.25 Safety relay 2 feedback). | <i>None</i> |
| | None | No output connected | |
| | DO X113:7 & X114:7 | Redundant output X113:7 & X114:7 | |
| | DO X113:8 & X114:8 | Redundant output X113:8 & X114:8 | |
| | DO X113:9 & X114:9 | Redundant output X113:9 & X114:9 | |
| SAFEIO.25 | Safety relay 2 feedback | Sets the digital feedback input of safety relay 2.
Parameter SAFEIO.26 Safety relay 2 feedback type sets the type of the feedback input. | <i>None</i> |
| | None | No input connected | |
| | DI X113:1 | Single input X113:1 | |
| | DI X113:2 | Single input X113:2 | |
| | DI X113:3 | Single input X113:3 | |
| | DI X113:4 | Single input X113:4 | |
| | DI X114:1 | Single input X114:1 | |
| | DI X114:2 | Single input X114:2 | |
| | DI X114:3 | Single input X114:3 | |
| | DI X114:4 | Single input X114:4 | |
| SAFEIO.26 | Safety relay 2 feedback type | Sets the type of the feedback signal for safety relay 2.
Note: The feedback delay is 800 ms for both feedback types, that is, a feedback signal from the safety relay must be received within 800 ms. | <i>Mechanically linked NC contacts</i> |
| | Mechanically linked NC contacts | Feedback of the safety relay is NC (inverted state compared with the relay). | |
| | Mechanically linked NO contacts | Feedback of the safety relay is NO (same state compared with the relay). | |
| SAFEIO.31 | DI diagnostic pulse length | Sets the length of the diagnostic pulse for digital inputs. | <i>1 ms</i> |
| | 0.5 ms | Length of the diagnostic pulse is 0.5 ms. | |
| | 1 ms | Length of the diagnostic pulse is 1 ms. | |
| | 2 ms | Length of the diagnostic pulse is 2 ms. | |
| SAFEIO.32 | DI diagnostic pulse period | Sets the time during which the FSO module must receive at least one whole diagnostic pulse. | 10,000 ms |

| Index | Name/Value | Description | Factory default |
|-----------|-----------------------------|---|-----------------|
| | 50...59,000 ms | Time | |
| SAFEIO.33 | DI X113:1 diag pulse on/off | Sets the diagnostic pulse of digital input X113:1 on or off. | <i>On</i> |
| | Off | Diagnostic pulse off | |
| | On | Diagnostic pulse on | |
| SAFEIO.34 | DI X113:2 diag pulse on/off | Sets the diagnostic pulse of digital input X113:2 on or off. | <i>On</i> |
| | Off | Diagnostic pulse off | |
| | On | Diagnostic pulse on | |
| SAFEIO.35 | DI X113:3 diag pulse on/off | Sets the diagnostic pulse of digital input X113:3 on or off. | <i>On</i> |
| | Off | Diagnostic pulse off | |
| | On | Diagnostic pulse on | |
| SAFEIO.36 | DI X113:4 diag pulse on/off | Sets the diagnostic pulse of digital input X113:4 on or off | <i>On</i> |
| | Off | Diagnostic pulse off | |
| | On | Diagnostic pulse on | |
| SAFEIO.37 | DI X114:1 diag pulse on/off | Sets the diagnostic pulse of digital input X114:1 on or off. | <i>On</i> |
| | Off | Diagnostic pulse off | |
| | On | Diagnostic pulse on | |
| SAFEIO.38 | DI X114:2 diag pulse on/off | Sets the diagnostic pulse of digital input X114:2 on or off. | <i>On</i> |
| | Off | Diagnostic pulse off | |
| | On | Diagnostic pulse on | |
| SAFEIO.39 | DI X114:3 diag pulse on/off | Sets the diagnostic pulse of digital input X114:3 on or off | <i>On</i> |
| | Off | Diagnostic pulse off | |
| | On | Diagnostic pulse on | |
| SAFEIO.40 | DI X114:4 diag pulse on/off | Sets the diagnostic pulse of digital input X114:4 on or off | <i>On</i> |
| | Off | Diagnostic pulse off | |
| | On | Diagnostic pulse on | |
| SAFEIO.51 | DO diagnostic pulse length | Sets the length of the diagnostic pulse for digital outputs. | <i>1 ms</i> |
| | 0.5 ms | Length of the diagnostic pulse is 0.5 ms. | |
| | 1 ms | Length of the diagnostic pulse is 1 ms. | |
| | 2 ms | Length of the diagnostic pulse is 2 ms. | |
| SAFEIO.52 | DO diagnostic pulse period | Sets the time during which the FSO module must receive at least one whole diagnostic pulse. | 10,000 ms |
| | 50...59,000 ms | Time | |

| Index | Name/Value | Description | Factory default |
|-----------|-----------------------------|---|-------------------|
| SAFEIO.53 | DO X113:7 diag pulse on/off | Sets the diagnostic pulse of digital output X113:7 on or off. | <i>On</i> |
| | Off | Diagnostic pulse off | |
| | On | Diagnostic pulse on | |
| SAFEIO.54 | DO X113:8 diag pulse on/off | Sets the diagnostic pulse of digital output X113:8 on or off. | <i>On</i> |
| | Off | Diagnostic pulse off | |
| | On | Diagnostic pulse on | |
| SAFEIO.55 | DO X113:9 diag pulse on/off | Sets the diagnostic pulse of digital output X113:9 on or off. | <i>On</i> |
| | Off | Diagnostic pulse off | |
| | On | Diagnostic pulse on | |
| SAFEIO.56 | DO X114:7 diag pulse on/off | Sets the diagnostic pulse of digital output X114:7 on or off. | <i>On</i> |
| | Off | Diagnostic pulse off | |
| | On | Diagnostic pulse on | |
| SAFEIO.57 | DO X114:8 diag pulse on/off | Sets the diagnostic pulse of digital output X114:8 on or off. | <i>On</i> |
| | Off | Diagnostic pulse off | |
| | On | Diagnostic pulse on | |
| SAFEIO.58 | DO X114:9 diag pulse on/off | Sets the diagnostic pulse of digital output X114:9 on or off. | <i>On</i> |
| | Off | Diagnostic pulse off | |
| | On | Diagnostic pulse on | |
| SAFEIO.71 | DO X113:7 logic state | Sets the logic state of digital output X113:7. | <i>Active low</i> |
| | Active low | Active state of the output is low voltage. | |
| | Active high | Active state of the output is high voltage. | |
| SAFEIO.72 | DO X113:8 logic state | Sets the logic state of digital output X113:8. | <i>Active low</i> |
| | Active low | Active state of the output is low voltage. | |
| | Active high | Active state of the output is high voltage. | |
| SAFEIO.73 | DO X113:9 logic state | Sets the logic state of digital output X113:9. | <i>Active low</i> |
| | Active low | Active state of the output is low voltage. | |
| | Active high | Active state of the output is high voltage. | |
| SAFEIO.74 | DO X114:7 logic state | Sets the logic state of digital output X114:7. | <i>Active low</i> |
| | Active low | Active state of the output is low voltage. | |
| | Active high | Active state of the output is high voltage. | |
| SAFEIO.75 | DO X114:8 logic state | Sets the logic state of digital output X114:8. | <i>Active low</i> |
| | Active low | Active state of the output is low voltage. | |

| Index | Name/Value | Description | Factory default |
|-----------|-----------------------|--|-------------------|
| | Active high | Active state of the output is high voltage. | |
| SAFEIO.76 | DO X114:9 logic state | Sets the logic state of digital output X114:9. | <i>Active low</i> |
| | Active low | Active state of the output is low voltage. | |
| | Active high | Active state of the output is high voltage. | |

| SBUSGEN | | General parameters for safety fieldbuses | |
|------------|----------------------------------|---|-----------------|
| SBUSGEN.01 | SBUS activity and version | Activates or deactivates the safety fieldbus. | <i>Disabled</i> |
| | Disabled | Deactivates the safety fieldbus. | |
| | Version 1 | Activates version 1 of the safety fieldbus. | |
| SBUSGEN.06 | Safety fieldbus speed scaling | Sets the rpm value that corresponds to 20000 for safety fieldbus communication. | 1500.0 rpm |
| | 0.10...30000.0 | | |
| SBUSGEN.07 | Safety fieldbus position scaling | Sets the scaling value for the shaft rotation (base unit 1/1000 grad). If this parameter is set to 1000, value 400 in the safety fieldbus equals to one full shaft revolution.
Note: This parameter is relevant only when an encoder is used. | 1.0 |
| | 0.01...30000.0 | | |
| SBUSGEN.10 | STO indication passivation | Sets the type of the event that the FSO module generates when the FSO module is passivated due to safety fieldbus problems. | <i>Fault</i> |
| | None | No event generated | |
| | Fault | Fault generated | |
| | Warning | Warning generated | |
| | Event | Pure event generated | |

| PROFIsafe | | Parameters for PROFIsafe | |
|--------------|-------------------------|---|--------------|
| PROFIsafe.11 | PROFIsafe F_Dest_Add | Sets the PROFIsafe destination address for FSO which is used in the safety communication network.
Note: This address must be the same as is set in the F-Parameters for the PROFIsafe module properties (F_Dest_Add). For more information, see section Configuring the safety PLC on page 233. | 1 |
| | 1...65534 | | |
| PROFIsafe.12 | PROFIsafe telegram type | Shows the PROFIsafe telegram type. | <i>0x221</i> |
| | 0x221 | PROFIsafe telegram 0x221 (545). Corresponds to profile ABB_PS1 in the GSD file. See section Downloading the GSD file on page 233. | |

| Index | Name/Value | Description | Factory default |
|-------|------------|---|-----------------|
| | 0x222 | <p>PROFIsafe telegram 0x222 (546).
Corresponds to profile ABB_PS2 in the GSD file. See section Downloading the GSD file on page 233.</p> <p>Note: This profile requires that an encoder is used.</p> | |

Status and control words

This table lists the FSO module and drive status and control words. You can view these in the ACS880/DCS880 parameter tab of Drive Composer pro.



WARNING! This data is purely informative. Do not use it for any functional safety purposes.

| Index | Name/Value | Description | | | | | | | | | | | | | | | | | | | | | | | | | | | | | | |
|---------------|---------------|--|-----|------|--------|---|--------------|-----------------|---|--------------|-----------------|---|--------------|-----------------|---|--------------|-----------------|---|--------------|-----------------|---|--------------|-----------------|---|--------------|-----------------|---|--------------|-----------------|------|----------|--|
| Safety | | | | | | | | | | | | | | | | | | | | | | | | | | | | | | | | |
| 200.01 | FSO speed ch1 | Shows the motor speed estimate 1 of the FSO module. The FSO module reads the value from the drive via communication channel 1.
When safety encoder is used with FSE-31 module, this parameter shows the speed measured with the safety encoder. | | | | | | | | | | | | | | | | | | | | | | | | | | | | | | |
| | 0.00 ... rpm | Speed
FbEq16: 1 = 1 rpm; FbEq32: 100 = 1 rpm | | | | | | | | | | | | | | | | | | | | | | | | | | | | | | |
| 200.02 | FSO speed ch2 | Shows the motor speed estimate 2 of the FSO module. The FSO module reads the source data from the drive via communication channel 2 and calculates the speed estimate 2 using the data.
When safety encoder is used with FSE-31 module, this parameter shows the speed measured with the safety encoder.
Note: For a DCS880 drive, the value of this parameter is always 0 when no encoder is used. | | | | | | | | | | | | | | | | | | | | | | | | | | | | | | |
| | 0.00 ... rpm | Speed
FbEq16: 1 = 1 rpm; FbEq32: 100 = 1 rpm | | | | | | | | | | | | | | | | | | | | | | | | | | | | | | |
| 200.03 | FSO DI status | Shows the states of the FSO digital inputs. | | | | | | | | | | | | | | | | | | | | | | | | | | | | | | |
| | | <table border="1"> <thead> <tr> <th>Bit</th> <th>Name</th> <th>Values</th> </tr> </thead> <tbody> <tr> <td>0</td> <td>Input X113:1</td> <td>0 = Off, 1 = On</td> </tr> <tr> <td>1</td> <td>Input X113:2</td> <td>0 = Off, 1 = On</td> </tr> <tr> <td>2</td> <td>Input X113:3</td> <td>0 = Off, 1 = On</td> </tr> <tr> <td>3</td> <td>Input X113:4</td> <td>0 = Off, 1 = On</td> </tr> <tr> <td>4</td> <td>Input X114:1</td> <td>0 = Off, 1 = On</td> </tr> <tr> <td>5</td> <td>Input X114:2</td> <td>0 = Off, 1 = On</td> </tr> <tr> <td>6</td> <td>Input X114:3</td> <td>0 = Off, 1 = On</td> </tr> <tr> <td>7</td> <td>Input X114:4</td> <td>0 = Off, 1 = On</td> </tr> <tr> <td>8-15</td> <td>Reserved</td> <td></td> </tr> </tbody> </table> | Bit | Name | Values | 0 | Input X113:1 | 0 = Off, 1 = On | 1 | Input X113:2 | 0 = Off, 1 = On | 2 | Input X113:3 | 0 = Off, 1 = On | 3 | Input X113:4 | 0 = Off, 1 = On | 4 | Input X114:1 | 0 = Off, 1 = On | 5 | Input X114:2 | 0 = Off, 1 = On | 6 | Input X114:3 | 0 = Off, 1 = On | 7 | Input X114:4 | 0 = Off, 1 = On | 8-15 | Reserved | |
| Bit | Name | Values | | | | | | | | | | | | | | | | | | | | | | | | | | | | | | |
| 0 | Input X113:1 | 0 = Off, 1 = On | | | | | | | | | | | | | | | | | | | | | | | | | | | | | | |
| 1 | Input X113:2 | 0 = Off, 1 = On | | | | | | | | | | | | | | | | | | | | | | | | | | | | | | |
| 2 | Input X113:3 | 0 = Off, 1 = On | | | | | | | | | | | | | | | | | | | | | | | | | | | | | | |
| 3 | Input X113:4 | 0 = Off, 1 = On | | | | | | | | | | | | | | | | | | | | | | | | | | | | | | |
| 4 | Input X114:1 | 0 = Off, 1 = On | | | | | | | | | | | | | | | | | | | | | | | | | | | | | | |
| 5 | Input X114:2 | 0 = Off, 1 = On | | | | | | | | | | | | | | | | | | | | | | | | | | | | | | |
| 6 | Input X114:3 | 0 = Off, 1 = On | | | | | | | | | | | | | | | | | | | | | | | | | | | | | | |
| 7 | Input X114:4 | 0 = Off, 1 = On | | | | | | | | | | | | | | | | | | | | | | | | | | | | | | |
| 8-15 | Reserved | | | | | | | | | | | | | | | | | | | | | | | | | | | | | | | |

| Index | Name/Value | Description | | |
|--------|----------------------|--|----------------------|-----------------|
| 200.04 | FSO DO status | Shows the states of the FSO digital outputs. | | |
| | | Bit | Name | Values |
| | | 0 | Output X113:7 | 0 = Off, 1 = On |
| | | 1 | Output X113:8 | 0 = Off, 1 = On |
| | | 2 | Output X113:9 | 0 = Off, 1 = On |
| | | 4 | Output X114:7 | 0 = Off, 1 = On |
| | | 5 | Output X114:8 | 0 = Off, 1 = On |
| | | 6 | Output X114:9 | 0 = Off, 1 = On |
| | 7-15 | Reserved | | |
| 200.05 | FSO control word 1 | Shows the states of the FSO commands. | | |
| | | Bit | Name | Values |
| | | 0 | STO request | 0 = Off, 1 = On |
| | | 1 | SSE request | 0 = Off, 1 = On |
| | | 2 | SS1 request | 0 = Off, 1 = On |
| | | 3 | Reserved | |
| | | 4 | SAR0 request | 0 = Off, 1 = On |
| | | 5 | SAR1 request | 0 = Off, 1 = On |
| | | 6 | Reserved | |
| | | 7 | Reserved | |
| | | 8 | Reserved | |
| | | 9 | Reserved | |
| | | 10 | SLS1 request | 0 = Off, 1 = On |
| | | 11 | SLS2 request | 0 = Off, 1 = On |
| | | 12 | SLS3 request | 0 = Off, 1 = On |
| | | 13 | SLS4 request | 0 = Off, 1 = On |
| 14 | Reserved | | | |
| 15 | SDI positive request | 0 = Off, 1 = On | | |
| 200.06 | FSO control word 2 | Shows the states of the FSO commands. | | |
| | | Bit | Name | Values |
| | | 0 | SDI negative request | 0 = Off, 1 = On |
| | | 1 | CRC request | 0 = Off, 1 = On |
| | | 2 | FSO brake | 0 = Off, 1 = On |
| | | 3 | Variable SLS request | 0 = Off, 1 = On |
| | | 4 | SS1 modoff allowed | 0 = Off, 1 = On |
| | | 5 | SSE modoff allowed | 0 = Off, 1 = On |
| | 6-15 | Reserved | | |

| Index | Name/Value | Description | | |
|--------|-------------------|------------------------------|-----------------|--|
| 200.07 | FSO status word 1 | Shows the FSO status word 1. | | |
| | | Bit | Name | Values |
| | | 0 | FSO mode bit 1 | 0 = Undefined |
| | | 1 | FSO mode bit 2 | 1 = Start-up mode |
| | | 2 | FSO mode bit 3 | 2 = Running mode
3 = Fail-safe mode
4 = Configuration mode |
| | | 3 | FSO state bit 1 | 0 = Safe state
1 = Operational state |
| | | 4 | FSO state bit 2 | |
| | | 5 | FSO STO active | 0 = Off, 1 = On |
| | | 6 | Brake state | 0 = Off, 1 = On |
| | | 7 | POUS monitoring | 0 = Off, 1 = On |
| | | 8 | SSE monitoring | 0 = Off, 1 = On |
| | | 9 | SS1 monitoring | 0 = Off, 1 = On |
| | | 10 | Reserved | |
| | | 11 | SAR0 monitoring | 0 = Off, 1 = On |
| | | 12 | SAR1 monitoring | 0 = Off, 1 = On |
| | | 13 | Reserved | |
| 14 | Reserved | | | |
| 15 | Reserved | | | |

| Index | Name/Value | Description | | | | | | | | | | | | | | | | | | | | | | | | | | | | | | | | | | | | | | | | | | | | | | | | | | | |
|--------|--|--|-----|------|--------|---|----------|--|---|-----------------|-----------------|---|-----------------|-----------------|---|-----------------|-----------------|---|-----------------|-----------------|---|----------|--|---|--|-----------------|---|---|-----------------|---|--|-----------------|---|--|-----------------|----|--|-----------------|----|--|-----------------|----|----------------|-----------------|----|----------|--|----|--------------------|-----------------|----|----------|--|
| 200.08 | FSO status word 2 | Shows the FSO status word 2. | | | | | | | | | | | | | | | | | | | | | | | | | | | | | | | | | | | | | | | | | | | | | | | | | | | |
| | | <table border="1"> <thead> <tr> <th>Bit</th> <th>Name</th> <th>Values</th> </tr> </thead> <tbody> <tr> <td>0</td> <td>Reserved</td> <td></td> </tr> <tr> <td>1</td> <td>SLS1 monitoring</td> <td>0 = Off, 1 = On</td> </tr> <tr> <td>2</td> <td>SLS2 monitoring</td> <td>0 = Off, 1 = On</td> </tr> <tr> <td>3</td> <td>SLS3 monitoring</td> <td>0 = Off, 1 = On</td> </tr> <tr> <td>4</td> <td>SLS4 monitoring</td> <td>0 = Off, 1 = On</td> </tr> <tr> <td>5</td> <td>Reserved</td> <td></td> </tr> <tr> <td>6</td> <td>SDI positive monitoring active and rotation direction correct.</td> <td>0 = Off, 1 = On</td> </tr> <tr> <td>7</td> <td>SDI negative monitoring active and rotation direction correct</td> <td>0 = Off, 1 = On</td> </tr> <tr> <td>8</td> <td>SSM1 monitoring active and speed within limits</td> <td>0 = Off, 1 = On</td> </tr> <tr> <td>9</td> <td>SSM2 monitoring active and speed within limits</td> <td>0 = Off, 1 = On</td> </tr> <tr> <td>10</td> <td>SSM3 monitoring active and speed within limits</td> <td>0 = Off, 1 = On</td> </tr> <tr> <td>11</td> <td>SSM4 monitoring active and speed within limits</td> <td>0 = Off, 1 = On</td> </tr> <tr> <td>12</td> <td>SMS monitoring</td> <td>0 = Off, 1 = On</td> </tr> <tr> <td>13</td> <td>Reserved</td> <td></td> </tr> <tr> <td>14</td> <td>var SLS monitoring</td> <td>0 = Off, 1 = On</td> </tr> <tr> <td>15</td> <td>Reserved</td> <td></td> </tr> </tbody> </table> | Bit | Name | Values | 0 | Reserved | | 1 | SLS1 monitoring | 0 = Off, 1 = On | 2 | SLS2 monitoring | 0 = Off, 1 = On | 3 | SLS3 monitoring | 0 = Off, 1 = On | 4 | SLS4 monitoring | 0 = Off, 1 = On | 5 | Reserved | | 6 | SDI positive monitoring active and rotation direction correct. | 0 = Off, 1 = On | 7 | SDI negative monitoring active and rotation direction correct | 0 = Off, 1 = On | 8 | SSM1 monitoring active and speed within limits | 0 = Off, 1 = On | 9 | SSM2 monitoring active and speed within limits | 0 = Off, 1 = On | 10 | SSM3 monitoring active and speed within limits | 0 = Off, 1 = On | 11 | SSM4 monitoring active and speed within limits | 0 = Off, 1 = On | 12 | SMS monitoring | 0 = Off, 1 = On | 13 | Reserved | | 14 | var SLS monitoring | 0 = Off, 1 = On | 15 | Reserved | |
| Bit | Name | Values | | | | | | | | | | | | | | | | | | | | | | | | | | | | | | | | | | | | | | | | | | | | | | | | | | | |
| 0 | Reserved | | | | | | | | | | | | | | | | | | | | | | | | | | | | | | | | | | | | | | | | | | | | | | | | | | | | |
| 1 | SLS1 monitoring | 0 = Off, 1 = On | | | | | | | | | | | | | | | | | | | | | | | | | | | | | | | | | | | | | | | | | | | | | | | | | | | |
| 2 | SLS2 monitoring | 0 = Off, 1 = On | | | | | | | | | | | | | | | | | | | | | | | | | | | | | | | | | | | | | | | | | | | | | | | | | | | |
| 3 | SLS3 monitoring | 0 = Off, 1 = On | | | | | | | | | | | | | | | | | | | | | | | | | | | | | | | | | | | | | | | | | | | | | | | | | | | |
| 4 | SLS4 monitoring | 0 = Off, 1 = On | | | | | | | | | | | | | | | | | | | | | | | | | | | | | | | | | | | | | | | | | | | | | | | | | | | |
| 5 | Reserved | | | | | | | | | | | | | | | | | | | | | | | | | | | | | | | | | | | | | | | | | | | | | | | | | | | | |
| 6 | SDI positive monitoring active and rotation direction correct. | 0 = Off, 1 = On | | | | | | | | | | | | | | | | | | | | | | | | | | | | | | | | | | | | | | | | | | | | | | | | | | | |
| 7 | SDI negative monitoring active and rotation direction correct | 0 = Off, 1 = On | | | | | | | | | | | | | | | | | | | | | | | | | | | | | | | | | | | | | | | | | | | | | | | | | | | |
| 8 | SSM1 monitoring active and speed within limits | 0 = Off, 1 = On | | | | | | | | | | | | | | | | | | | | | | | | | | | | | | | | | | | | | | | | | | | | | | | | | | | |
| 9 | SSM2 monitoring active and speed within limits | 0 = Off, 1 = On | | | | | | | | | | | | | | | | | | | | | | | | | | | | | | | | | | | | | | | | | | | | | | | | | | | |
| 10 | SSM3 monitoring active and speed within limits | 0 = Off, 1 = On | | | | | | | | | | | | | | | | | | | | | | | | | | | | | | | | | | | | | | | | | | | | | | | | | | | |
| 11 | SSM4 monitoring active and speed within limits | 0 = Off, 1 = On | | | | | | | | | | | | | | | | | | | | | | | | | | | | | | | | | | | | | | | | | | | | | | | | | | | |
| 12 | SMS monitoring | 0 = Off, 1 = On | | | | | | | | | | | | | | | | | | | | | | | | | | | | | | | | | | | | | | | | | | | | | | | | | | | |
| 13 | Reserved | | | | | | | | | | | | | | | | | | | | | | | | | | | | | | | | | | | | | | | | | | | | | | | | | | | | |
| 14 | var SLS monitoring | 0 = Off, 1 = On | | | | | | | | | | | | | | | | | | | | | | | | | | | | | | | | | | | | | | | | | | | | | | | | | | | |
| 15 | Reserved | | | | | | | | | | | | | | | | | | | | | | | | | | | | | | | | | | | | | | | | | | | | | | | | | | | | |

| Index | Name/Value | Description | | | |
|--------|---------------------|--------------------------------|--------------------|-------------------------------|-----------------|
| 200.09 | Drive status word 1 | Shows the drive status word 1. | | | |
| | | Bit | Name | Description | Values |
| | | 0 | Drive status bit 1 | | 0 = Disabled |
| | | 1 | Drive status bit 2 | | 1 = Readyon |
| | | 2 | Drive status bit 3 | | 2 = Readyrun |
| | | 3 | Drive status bit 4 | | 3 = Starting |
| | | | | | 4 = Readyref |
| | | | | | 5 = Stopping |
| | | | | | 6 = Faulted |
| | | 4 | Reserved | | |
| | | 5 | Encoder present | An encoder is present. | 0 = Off, 1 = On |
| | | 6 | Modulation | Drive modulation on or off. | 0 = Off, 1 = On |
| | | 7 | STO circuit 1 | State of drive STO circuit 1. | 0 = Off, 1 = On |
| | | 8 | STO circuit 2 | State of drive STO circuit 2. | 0 = Off, 1 = On |
| | | 9 | SS1 active | State on the drive side | 0 = Off, 1 = On |
| | | 10 | Reserved | | |
| | | 11 | SAR0 active | | 0 = Off, 1 = On |
| | | 12 | SAR1 active | | 0 = Off, 1 = On |
| | | 13 | Reserved | | |
| | | 14 | Reserved | | |
| | | 15 | Reserved | | |
| | | | | | |

| Index | Name/Value | Description | | | |
|--------|---------------------|--------------------------------|---------------------|--|-----------------|
| 200.10 | Drive status word 2 | Shows the drive status word 2. | | | |
| | | Bit | Name | Description | Values |
| | | 0 | Reserved | | |
| | | 1 | SLS1 active | State on the drive side | 0 = Off, 1 = On |
| | | 2 | SLS2 active | | 0 = Off, 1 = On |
| | | 3 | SLS3 active | | 0 = Off, 1 = On |
| | | 4 | SLS4 active | | 0 = Off, 1 = On |
| | | 5 | Reserved | | |
| | | 6 | SDI positive active | | 0 = Off, 1 = On |
| | | 7 | SDI negative active | | 0 = Off, 1 = On |
| | | 8 | Drive brake state | State of the drive operational brake. | 0 = Off, 1 = On |
| | | 9 | STO 1 diag | The drive has noticed an STO diagnostic pulse on circuit 1 or 2. | 0, 1 |
| | | 10 | STO 2 diag | | 0, 1 |
| 11-15 | Reserved | | | | |

12

Start-up

Contents of this chapter

This chapter describes the general precautions to be taken before starting up the safety system for the first time.

Safety considerations

The start-up must be done by a qualified electrical professional who has appropriate knowledge on functional, machine and process safety. The safety instructions must be followed during the start-up. See the drive and the safety component specific safety instructions in the individual product manuals.



WARNING! Until all the safety functionality is validated, the system must not be considered safe.



Note: The safety of the machine users must be ensured in each phase of the application life cycle (for example, commissioning, start-up, maintenance, etc.).

Checks

Before starting the system for the first time, make sure that

- the installation has been checked, according to the individual product checklists (drive, safety component) and the checklists provided in this document (see chapter [Installation checklists](#)).
- all necessary configuration steps have been completed
- all tools are cleared from the installation area to prevent short circuits and projectiles
- starting the system does not cause any danger
- all safety functions which are configured into use, are validated according to chapter [Verification and validation](#) on page [459](#).



13

Verification and validation

Contents of this chapter

This chapter describes verification and validation of the implemented safety functionality.

Verification and validation produce documented proof of the compliance of the implementation with specified safety requirements.

Further information can be found in *Technical guide No. 10 - Functional safety* (3AUA0000048753 [English]).

Verifying the achieved SIL/PL level

Verification of the functional safety system demonstrates and ensures that the implemented safety system meets the requirements specified for the system in the safety requirements specification phase.

The most convenient way to verify the required SIL/PL level reached with the implemented system is to use a specific safety calculator software.

Purpose of the validation testing

The purpose of the validation testing is to verify that the safety functions which are used in the safety system, operate as required in the application, and that the safety requirements specification (SRS) arising from the risk assessment is fulfilled. By testing, the plausibility of the safety functions is ensured against the SRS requirements. All situations relevant to the application according to the risk assessment must be tested. For example, possible configuration errors of the safety functions should be found by the validation testing.

Preconditions for validation testing

Validation testing is done for the entire and complete safety system. It is recommended to do all the verification and validation tests so that the real load of the application is connected to the motor. The whole safety system (for example, emergency stop buttons, light curtains, etc.) must be installed, set-up, and the drives commissioned and ready to use before the safety system can be tested. All safety functions in use must be tested with each of the drive, and/or as a whole section of drives (span of control of safety function).

Validation procedure

■ General

It is always the responsibility of the machine builder/designer/integrator to ensure that the operation of all the required safety functions has been appropriately verified and validated.

It is necessary to validate first the general settings of the FSO module and the safety encoder (if in use) before the validation of the safety functions.

Always configure and validate the STO and SSE functions. An internal monitoring of the FSO module can trigger the STO or SSE function even if you have not defined an external request signal for them.



WARNING! The system must not be considered safe until the safety functionality, which is necessary for safe use of the application based on the risk assessment, is validated. Validation of each safety function must be performed before the application is taken into the use.

The validation tests using the start-up checklists later in this section must be performed:

- at initial configuration of the safety function
 - after any changes related to the safety function (wiring, components, settings, etc.)
 - after any maintenance work related to the safety function.
-

The validation test must include at least the following steps:

- preparing a validation test plan
- testing all commissioned functions for proper operation in the final complete safety system
- testing all used inputs for proper operation, also for the input redundancy. See also [Validation of redundant inputs](#) on page 466.
- testing all used outputs for proper operation
- documenting all validation tests performed
- testing person signing and archiving the validation test report for further reference.

■ Validation test reports

You must store the signed acceptance test reports in the logbook of the machine. The report must include, as required by the referred standards:

- description of the safety application (including a figure)
- a description and revisions of safety components that are used in the safety application
- a list of all safety functions that are used in the safety application
- a list of all safety related parameters and their values (the drive STO has no safety-related parameters, but listing the non-safety related parameter *31.22 STO indication run/stop* and its setting is recommended)
- documentation of start-up activities, references to failure reports and resolution of failures
- the test results for each safety function, all safety parameter values including the CRC value of the safety configuration (parameter [200.254](#)), date of the tests and confirmation by the test personnel.

You must store any new acceptance test reports performed due to changes or maintenance in the logbook of the machine.

■ Competence

The validation test of the safety function must be carried out by a competent person with expertise and knowledge of the safety function as well as functional safety, as required by IEC 61508-1 clause 6. The test procedures and report must be documented and signed by this person.

■ Tools

You need the Drive Composer pro PC tool to perform the validation procedures.

■ Validation of the PROFIsafe connection

Follow the steps below to validate the PROFIsafe connection:

1. Make sure that the PROFIsafe communication is enabled in FSO parameter [200.222 Safety bus type](#).
 2. Make sure that the fieldbus module (FENA-21 or FPNO-21) is configured into use in the drive. See *ACS880 primary control program firmware manual* or *DCS880 firmware manual*, and *FENA-01/-11/-21 Ethernet adapter module user's manual* (3AUA0000093568 [English]) or *FPNO-21 PROFINET fieldbus adapter module user's manual* (3AXD50000158614 [English]).
 3. Make sure that correct option slot is configured for PROFIsafe. The value of FSO module parameter [200.223 Safety fieldbus adapter slot](#) must correspond to the FBA channel of the fieldbus interface (FBA A or FBA B).
 4. Make sure that the fieldbus module is configured correctly in drive parameter group 51 or 54 (depends on which FBA channel [FBA A or FBA B] is used). See the appropriate fieldbus module manual for details. Most importantly:
 - parameter *51.02/54.02 Protocol/Profile* must be set to configure one of the PROFINET profiles,
 - parameter *51.21* or *54.21* must be set to *Enabled* (0) to enable sending of the PROFIsafe diagnosis messages.
 5. Make sure that the PROFIsafe watchdog time for the fieldbus module that is configured in the controller station is calculated as specified in section [Calculating the watchdog time](#) on page 229.
 6. Make sure that the PROFIsafe address (F_Dest_Add) of the FSO module is unique in the network and the same value is set in FSO parameter [PROFIsafe.11 PROFIsafe F_Dest_Add](#) and in the safety controller station.
 7. Make sure that the PROFIsafe address (F_Source_Add) of the safety PLC is unique in the network.
 8. Make sure that the PROFIsafe speed scaling value in FSO parameter [SBUSGEN.06 Safety fieldbus speed scaling](#) is calculated as specified in section [Configuring the safety fieldbus communication](#) on page 320.
 9. Make sure that the safety controller station is commissioned according to its instructions. Make sure that the correct GSD-file is in use, for example, a correct PS profile is in use.
 10. Make sure that the communication between controller and PROFINET/PROFIsafe devices is established properly.
 11. Verify by activating some suitable safety function in each of the FSOs modules in PROFIsafe network, that the safety function is activated in correct drive.
-

12. Verify by disconnecting the PROFINET cable from the fieldbus adapter that correct FSO module is passivated and SSE function is activated.
13. Make sure that the drive event log does not contain any unexpected entries. See chapter [Fault tracing](#) for details.
14. Make sure that the diagnostic messages at the safety controller station (PLC) do not contain any unexpected entries.

■ Validation of the safety encoder interface

It is necessary to validate the encoder interface and the safety functions using the safe speed information from the safety encoder.

Make sure that the FSE-31 safety encoder interface and the safety encoder are commissioned correctly according to the FSE module manual and the instructions of the encoder manufacturer. See the commissioning test chapter in the FSE module manual.

The following steps validate the diagnostic reaction of the FSO and FSE modules in case of cable faults of the safety encoder.

If an encoder or FSE module failure occurs, the reaction depends on the value of parameter [S_ENCGEN.11 FSE diagnostic failure reaction](#) (*STO*, *No STO*, or *Est switch not active load*).

Validation procedure:

1. Make sure that the correct installation instructions are followed when installing the safety encoder (see the FSE module manual and the encoder manual).
 2. Make sure that safety encoder is configured into use via FSO-21 parameters according to the instructions given in section [Configuring the safety encoder interface](#) on page 315.
 3. Make sure that there are no configuration or sanity check errors present in the safety configuration.
 4. Make sure that the encoder resolution (parameter [92.10 Pulses/revolution](#) in the safety configuration of the FSO module) is set according to the specification of the installed encoder.
 5. Make sure that the encoder diagnostics parameters [S_ENCGEN.11](#), [S_ENCGEN.14](#), and [92.17](#) are configured according to the encoder, and the application requirements.
 6. Make sure that drive parameter [90.45 Motor feedback fault](#) = *Warning*. **Note:** For a DCS880 drive, the equivalent parameter/setting is [31.35 Motor feedback fault](#) = *EMF/Warning*.
-

7. Make sure that drive parameters 92.1, 92.2, 92.10, 92.17, 91.11 and 91.12 match with the safety configuration of the FSO module (safety settings view) and that these parameters are locked by the FSO module in the drive parameter view.
8. Make sure that you can run and stop the motor freely.
9. Start the drive to the motor speed typical for the application.
10. To confirm via the FSO module auto-diagnostics that the pulse count (92.10) is correct, it is necessary to do the encoder commissioning test so that the encoder does 11 full rotations. The FSO module requires 11 z-pulses to verify the pulse count of the safety encoder.

If this is not possible, use this alternative method:

Compare the speed estimation of the drive and measured speed from the encoder to make sure that the installation is correct, and the measurement shows correct speed value. Monitor the following actual values of the drive and FSO module:

| ACS880 | DCS880 |
|--|--|
| <i>01.02 Motor speed estimated</i> | <i>01.02 EMF speed filtered</i> |
| <i>01.04 Encoder 1 speed filtered</i> | <i>01.04 OnBoard encoder speed filtered</i> |
| <i>90.01 Motor speed for control</i> | <i>90.01 Motor speed for control</i> |
| <i>90.10 Encoder 1 speed</i> | <i>90.10 Encoder 1 speed</i> |
| <i>200.01 FSO speed ch1.</i> | <i>200.01 FSO speed ch1</i> |
| <i>200.02 FSO speed ch2.</i> | <i>200.02 FSO speed ch2.</i> |

11. Make sure that the encoder rotation direction is correct. See the parameters in the previous step. If it is not correct, exchange one differential pair in the cabling.

If you have configured [*S_ENCGEN.11 FSE diagnostic failure reaction*](#) to be *STO* or *No STO*, follow the steps below:

12. Make sure that system is safe for the coast stop test (follows).
13. a) If you have configured FSE diagnostic failure reaction ([*S_ENCGEN.11*](#)) to be *STO*:
 1. Cause an encoder failure by disconnecting the one encoder signal channel wire from the FSE module.
 2. Make sure the FSO module goes into the Fail-safe state, FSO general fault ([*7A8B*](#)) and FSO communication fault ([*A7D5*](#)) are indicated in the event log, the STO function of the drive is activated, and the drive trips for the encoder failure.

OR

b) If you have configured FSE diagnostic failure reaction ([S_ENCGEN.11](#)) to be *No STO*:

1. Cause an encoder failure by disconnecting the one encoder signal channel wire from the FSE module.
2. Activate any safety function except POUS or SSM.
3. Make sure the FSO module goes into the Fail-safe state, FSO general fault ([7A8B](#)) and FSO safety encoder fault ([A7D8](#)) are indicated in the event log, the STO function of the drive is activated, and the drive trips for the encoder failure.

Repeat steps 1...3 after step 13 with no safety functions active to make sure that the system does not trip to encoder fault.

14. Make sure that there are no unwanted faults in the drive event log.
15. Reconnect the encoder signal channel.
16. Re-boot the FSO module to exit the Fail-safe mode.
17. Restart the drive and make sure that the motor runs normally.

If you have configured FSE diagnostic failure reaction ([S_ENCGEN.11](#)) to be *Est switch not active load*, follow the steps below to validate the safety encoder interface:

12. Make sure that you can run and stop the motor freely.
13. Start the drive to the motor speed typical for the application.
14. Cause an encoder failure by disconnecting the one encoder signal channel wire from the FSE module.
15. Make sure that the correct warnings are generated: Encoder warning ([A7D8](#)), FSO general warning ([A7D0](#)), FSE Ch1 diag event ([B793](#)) and FSE Ch12 diag event ([B794](#)).
16. Activate a safety function (any other safety function except SDI, POUS or SSM).
17. Make sure that the system does not trip to encoder fault.
18. Reconnect the encoder signal channel.

All safety functions that are in use, must be validated both with the safe speed estimation and with the safety encoder when [S_ENCGEN.11 FSE diagnostic failure reaction](#) = *Est switch not active load*. Validation test about the transition from the encoder to the safe speed estimate must be done by disconnecting the encoder signal.

■ Validation of safety functions

Once the system is fully configured and wired for the safety functions, and the initial checks have been done, you must do the following functional test procedure for each safety function:

1. Run the system to the operational state, and make sure that the drive and FSO module are ready for the safety function validation. There are no active faults in the drive or FSO module.
2. Make sure that the acknowledgement method has been configured as required in the risk assessment of the application (manual or automatic acknowledgement).
3. Activate the safety function, for example through PROFIsafe or by an activating safety switch.
4. Verify that the desired functionality takes place, and the system behaves safely according to the requirements of the risk assessment.
5. Document the test results to the validation test report.
6. Sign and file the validation test report.

■ Validation of redundant inputs

If a safety function is configured to use redundant inputs, the diagnostic function of each redundant input must be verified.

This is an example of validation with the SS1 function. Inputs X113:1 and X114:1 are set for the SS1 input. Validation procedure:

1. Remove one channel from the FSO input 1 for SS1 function (for example, input X113:1).
2. Make sure that the FSO module activates the SS1 function (FSO SS1 request).
3. Make sure that the warning of redundant inputs (*A7D0*) appears.
4. Connect the disconnected input channel back to the FSO input 1 for SS1.
5. Verify that it is not possible to acknowledge the SS1 function.
6. Request SS1 function by activating both input channels.
7. Make sure that the warning of the redundant inputs (*A7D0*) disappears.
8. Deactivate SS1 function.
9. Acknowledge the function.

Repeat this procedure for all redundant input(s), and with all safety functions that use the inputs.

■ Validation of safety I/O's

The safety I/O configuration (SAFEIO.xx parameters) and functionality including the test pulsing must be verified according to the application requirements. If safety relay outputs and their feedbacks are used in the application, the related diagnostic functions must also be verified.

■ Validation of the general settings

Make sure that the general settings of the safety functions are configured correctly according to your design. For a configuration example, see section [Configuring general settings](#) on page 314. Check the values of these parameters:

- [FSOGEN.41 Power-up acknowledgement](#)
 - [FSOGEN.42 Acknowledgement button input](#)
 - [FSOGEN.22 Motor nominal frequency](#)
 - [FSOGEN.21 Motor nominal speed](#)
 - [FSOGEN.51 Zero speed without encoder](#)
 - [FSOGEN.52 Zero speed with encoder](#)
 - [FSOGEN.61 STO indication ext request](#)
 - [FSOGEN.62 STO indication safety limit](#)
 - [FSOGEN.11 Stop completed output.](#)
-

■ Validation of the STO function



WARNING! Configure and validate the STO function independently and before other safety functions.

General validation principles:

- The STO function is the basic safety function. It must always be configured and validated before (and independent of) other safety functions. This is essential because the internal diagnostics of the FSO module can trigger the STO function even if no external request signal has been defined for the function.
- The STO function must always be tested with a separate request signal. The signal is connected to a suitable FSO module input, and the input is configured to be the interface for the STO request.
- If the stop by coast time from the maximum process speed to zero speed is not known, it must be measured, and parameter [STO.14 Time to zero speed with STO and modoff](#) set accordingly.
- If an encoder is not used, it must be ensured by other means (for example, by a visual check) that the motor shaft stops within the [STO.14](#) delay time and that the STO function cannot be acknowledged before the motor shaft has stopped. The only exception to this is when [STO.13 Restart delay after STO](#) has been set shorter than [STO.14](#) delay time. In that case, the fly-start of the motor is possible.

To validate the STO function:

1. Make sure that the input for the STO function is configured according to the wiring diagram.
2. Make sure that the output to indicate the drive STO state ([STO.21 STO output](#)) is configured correctly according to your design.
3. Make sure that the STO function is configured correctly according to your design. For a configuration example, see chapter [Configuring STO](#) on page 333. Check these settings:

Activation:

- [STO.11 STO input A](#)
- [STO.12 STO input B](#)
- **Note:** Activation can also come from the PROFIsafe.

Acknowledgement:

- [STO.02 STO acknowledgement](#)
- [FSOGEN.42 Acknowledgement button input](#) if manual acknowledgement is used.

Functionality:

- [STO.13 Restart delay after STO](#) (if fly-start is used)
-

- *STO.14 Time to zero speed with STO and modoff.* (This is the estimated time in which the motor coasts to a stop from the maximum process speed.)
- If with safety encoder: *FSOGEN.52 Zero speed with encoder.*

Indication:

- *STO.21 STO output*
 - *STO.22 STO completed output*
 - *FSOGEN.11 Stop completed output*
4. If you made any changes, download and validate the configuration with the Drive Composer pro PC tool.
 5. Make sure that you can run and stop the motor freely.
 6. Activate the STO function. For example, by pressing an emergency stop button, which is wired to an FSO input for the STO function request.
 7. Remove the STO function request.
 8. Make sure that the drive STO is activated immediately after the STO request.
 9. Make sure that STO output (*STO.21*) shows the state of the drive STO correctly.
 10. a) If manual acknowledgement (or safebus acknowledgement) is in use: Verify by trying to acknowledge the function, that it is not possible before the motor speed is low enough:

With safe speed estimation:

 - Acknowledgement is not possible before coast time defined by parameter *STO.14 Time to zero speed with STO and modoff*
 - If fly start is allowed, acknowledgement is not possible before the time defined by parameter *STO.13 Restart delay after STO* has elapsed.

With safety encoder:

 - Acknowledgement is not possible before the speed is below safety zero speed limit *FSOGEN.52 Zero speed with encoder.*
 - If fly start is allowed, acknowledgement is not possible before the time defined by parameter *STO.13 Restart delay after STO* has elapsed.
 - b) If automatic acknowledgement is in use: Verify that STO function is not acknowledged before the motor is in safe state. See the conditions above.
-

■ Validation of the SBC function

SBC function always uses the drive STO.

Drive STO is always activated immediately in the following cases/situations:

- FSO STO function
- SSE, when it is configured to be immediate STO
- SSE ramp or SS1 function is completed.

Validation of the delayed brake function

1. Check the wiring between the FSO module and safe brake, and make sure that they are done correctly according to the design.
2. Make sure that the SBC function is configured correctly according to your design. For a configuration example, see section [How to configure the SBC in the STO function](#) on page 331. Check these settings:

Functionality:

- [SBC.11 STO SBC usage](#) = *Delayed brake*
 - [SBC.12 STO SBC delay](#)
 - [SBC.13 SBC time to zero speed](#)
 - [SBC.21 SBC output](#)
 - [SBC.22 SBC feedback action](#)
 - [SAFEIO.22 Safety relay 1 feedback](#)
 - [SAFEIO.23 Safety relay 1 feedback type](#).
3. Check that the drive STO and the SBC are activated correctly based on your application needs.
 - a) When positive STO SBC delay ([SBC.12](#)) is used: Check that the drive STO is activated first and the SBC after the delay has elapsed.

Note: When an encoder is used: If the zero speed limit ([FSOGEN.52](#)) is reached before the positive STO SBC delay ([SBC.12](#)) has elapsed, the FSO module activates the SBC immediately when the motor speed is below the zero speed limit.
 - b) When [SBC.12 STO SBC delay](#) is 0 ms, Check that the drive STO is activated at the same time as the SBC.
 - c) When negative STO SBC delay ([SBC.12](#)) is used: Check that the SBC is activated first and the drive STO after the delay has elapsed.
 4. Make sure that the required failure reaction ([SBC.22](#)) takes place if there is no SBC feedback signal ([SAFEIO.22](#)). For example, disconnect the SBC feedback cable to verify.
-

Validation of the speed limit activated SBC

This feature is possible with:

- the safe speed estimate with the SS1 or SSE ramp
- the safety encoder with the SS1 or SSE ramp, and with the STO function.

Procedure:

1. Check the wiring between the FSO module and safe brake, and make sure that they are done correctly according to the design.
2. Make sure that the SBC function is configured correctly according to your design. For a configuration example, see chapter [How to configure the SBC in the STO function](#) on page 331. Check these settings:

Functionality:

- [SBC.11 STO SBC usage](#) = speed limit
 - [SBC.12 STO SBC delay](#)
 - [SBC.13 SBC time to zero speed](#)
 - [SBC.14 STO SBC speed](#) speed > 0 rpm
 - [SBC.15 SSE/SS1 SBC speed](#) > 0 rpm
 - [SBC.21 SBC output](#)
 - [SBC.22 SBC feedback action](#)
 - [SAFEIO.22 Safety relay 1 feedback](#)
 - [SAFEIO.23 Safety relay 1 feedback type](#).
3. Check that the drive STO and the SBC are activated correctly based on your application needs.
 4. Check that the brake is activated at the correct speed.
 - a) When [SBC.12 STO SBC delay](#) is 0 ms or greater, check that the SBC and drive STO is activated at the same time at the speed limit. With the STO function this parameter does not have any effect.
 - b) When a negative [SBC.12 STO SBC delay](#) is used: Check that the SBC is activated at the speed limit, and the drive STO after the delay has elapsed. This parameter is only relevant for the SS1 or SSE ramp and for the STO function in the encoder failure situation.
 5. Make sure that the required failure reaction ([SBC.22](#)) takes place if there is no SBC feedback signal ([SAFEIO.22](#)). For example, disconnect the SBC feedback cable to verify.
-

■ Validation of the SSE function

Always configure and validate the SSE function. Test the SSE function always with a separate function request, for example by activating it via a suitable input configured for the SSE.

Internal diagnostics of the FSO module, trip limit hit cases and PROFIsafe passivation will trigger the SSE function even if you have not defined an external request signal for the SSE. For example, the FSO module activates the SSE function if an SLS trip limit hit occurs. The SSE function must be configured as SSE with STO, SSE with ramp stop, or SSE with time monitoring, based on the risk assessment of the application. The configuration must also cover the worst-case situation in case any of the issues above triggers the SSE function, or in case any stopping function with the SSE triggers the SSE.

Validation of the SSE with immediate STO function with safe speed estimation

1. Make sure that the input for the SSE function is configured according to the wiring diagram.
2. Make sure that the SSE function is configured correctly according to your design. For a configuration example, see chapter [How to configure SSE with immediate STO](#) on page 353). Check these settings:

Activation:

- [SSE.11 SSE input A](#)
- [SSE.12 SSE input B](#).
- **Note:** Activation can also come from the PROFIsafe.

Acknowledgement:

- [STO.02 STO acknowledgement](#)
- [FSOGEN.42 Acknowledgement button input](#) if manual acknowledgement is used.

Functionality:

- [SSE.13 SSE function](#) = *Immediate STO*
- [STO.14 Time to zero speed with STO and modoff](#). ([STO.14](#) is the time in which the motor coasts to a stop from the maximum speed.)

Indication:

- [SSE.21 SSE output](#)
- [SSE.22 SSE completed output](#)
- [FSOGEN.11 Stop completed output](#).

3. If you made any changes, download and validate the configuration with the Drive Composer pro PC tool.
 4. Make sure that you can run and stop the motor freely. Start the drive.
-

5. Activate the SSE function. For example, press the emergency stop button, which is wired to the FSO input for the SSE function.
6. Make sure that the drive STO is activated immediately after the SSE request.
7. Remove the SSE function user request.
8. a) If manual acknowledgement (or safebus acknowledgement) is in use: Verify by trying to acknowledge the function, that it is not possible before the motor is in safe state.
b) If automatic acknowledgement is in use: Make sure that the function is not acknowledged and that the delays are correctly configured by verifying that the drive cannot be restarted before the motor is in safe state.

Validation of the SSE with emergency ramp function

1. Make sure that the input for the SSE function is configured according to the wiring diagram.
2. Make sure that the SSE function and SAR0 setting or time monitoring limit is configured correctly according to your design. For a configuration example see section [How to configure SSE with time monitoring](#) on page 356 or [How to configure SSE with ramp monitoring](#) on page 357. Check these settings:

Activation:

- [SSE.11 SSE input A](#)
- [SSE.12 SSE input B](#).
- **Note:** activation can also come from the PROFIsafe

Acknowledgement:

- [STO.02 STO acknowledgement](#)
- [FSOGEN.42 Acknowledgement button input](#) if manual acknowledgement is used.

Functionality:

- [SSE.13 SSE function = Emergency ramp](#)
- [200.202 SAR speed scaling](#)
- [200.201 SAR0 ramp time to zero](#)
- [SSE.16 SSE ramp zero speed delay for STO](#), if used
- With safe speed estimation: [FSOGEN.51 Zero speed without encoder](#)
- With safety encoder: [FSOGEN.52 Zero speed with encoder](#)
- a) With ramp monitoring:
 - [SSE.14 SSE monitoring method = Ramp](#)
 - [SARx.02 SAR initial allowed range](#)
 - [SARx.11 SAR0 max ramp time to zero](#)
 - [SARx.12 SAR0 max ramp time to zero](#).

OR

b) With time monitoring:

- *SSE.14 SSE monitoring method = Time*
- *SSE.15 SSE delay for STO.*

Indication:

- *SSE.21 SSE output*
 - *SSE.21 SSE completed output*
 - *FSOGEN.11 Stop completed output.*
3. If you made any changes, download and validate the configuration with the Drive Composer pro PC tool.
 4. Make sure that you can run and stop the motor freely. Start the drive and accelerate the motor to the maximum speed of the application.
 5. Activate the SSE function. For example, press the emergency stop button which is wired to FSO module input for the SSE function.
 6. Remove the SSE function user request.
 7. a) If manual acknowledgement (or safebus acknowledgement) is in use: Verify by trying to acknowledge the function, that it is not possible before the motor speed is low enough:
 - With safe speed estimation: *FSOGEN.51 Zero speed without encoder.*
 - With safety encoder: *FSOGEN.52 Zero speed with encoder.*
 - b) If automatic acknowledgement is in use: Verify that the function is not acknowledged before the motor is in safe state, see the conditions above.
 8. Make sure that the motor speed decelerates as expected and the FSO does not trip to the monitoring limit (ramp or time).
 9. Start the drive and accelerate the motor to the maximum speed of the application.
 10. Activate the SSE function. For example, press the emergency stop button which is wired to the FSO module input for the SSE function.
 11. Remove the SSE function user request.
 12. Activate the coast stop of the drive.

You can, for example, cause an external fault trip in the drive. For more information, see the drive firmware manual (Group 31 *Fault functions*).
 13. Make sure that the FSO trips the drive, and activates the STO function according to the application requirements.
 14. Make sure that the acknowledgement of the STO function is not possible before the motor is in safe state
-

■ Validation of the SS1 function

1. Make sure that the input for the SS1 function is configured according to the wiring diagram.
2. Make sure that the SS1 function, and SAR1 setting or time monitoring limit is configured correctly according to your design. For a configuration example, see chapter *How to configure SS1 with time monitoring (SS1-t)* on page 342, or *How to configure SS1 with ramp monitoring (SS1-r)* on page 344. Check these settings:

Activation:

- [SS1.11 SS1 input A](#)
- [SS1.12 SS1 input B](#).
- **Note:** activation can also come from the PROFIsafe

Acknowledgement:

- [STO.02 STO acknowledgement](#)
- [FSOGEN.42 Acknowledgement button input](#) if manual acknowledgement is used.

Functionality:

- [SS1.01 SS1 activity and version](#) = Version 1
- [SS1.15 SS1-r ramp zero speed delay for STO](#) (if used)
- [200.202 SAR speed scaling](#)
- [200.112 SAR1 ramp time to zero](#)
- drive parameter [23.23 emergency stop time](#), if [200.112](#) = 0 ms
- if with safe speed estimation: [FSOGEN.51 Zero speed without encoder](#)
- if with safety encoder: [FSOGEN.52 Zero speed with encoder](#)
- a) If ramp monitoring is in use:
 - [SS1.13 SS1 type](#) = SS1-r
 - [SARx.02 SAR initial allowed range](#)
 - [SARx.21 SAR1 min ramp time to zero](#)
 - [SARx.22 SAR1 max ramp time to zero](#)

OR

b) If time monitoring is in use:

- [SS1.13 SS1 type](#) = SS1-t
- [SS1.14 SS1-t delay for STO](#).

Indication:

- [SS1.21 SS1 output](#)
- [SS1.22 SS1 completed output](#)
- [FSOGEN.11 Stop completed output](#).

3. If you made any changes, download and validate the configuration with the Drive Composer pro PC tool.

Note: SAR1 is common with the SS1, SLS and SDI functions. Any changes to the SAR1 values will have impact on these functions.

4. Make sure that you can run and stop the motor freely. Start the drive and accelerate to the maximum speed of the application.
5. Activate the SS1 function. For example, press an emergency stop button which is wired to FSO module input for the SS1 function.
6. Remove the SS1 function user request.
7. a) If manual acknowledgement (or safebus acknowledgement) is in use: Try to acknowledge the function and verify, that it is not possible before the motor is in safe state (the motor speed is not dangerously high for the application):
 - With safe speed estimation: Safety zero speed limit for *FSOGEN.51 Zero speed without encoder*
 - With safety encoder: *FSOGEN.52 Zero speed with encoder*

OR

- b) If automatic acknowledgement is in use: Verify that the function is not acknowledged before the motor speed is low enough. See the conditions above.
 8. Make sure that the motor speed decelerates as it is designed, and the FSO module does not trip to the monitoring limit (ramp or time).
 9. After the motor is in safe state and the function is acknowledged, start the drive again and accelerate to the maximum speed of the application.
 10. Activate the SS1 function. For example, by pressing the emergency stop button which is wired to FSO module input for the SS1 function.
 11. Remove the SS1 function user request.
 12. Activate the coast stop.

You can, for example, cause an external fault trip in the drive. For more information, see the drive firmware manual (Group 31 *Fault functions*).
 13. Make sure that the FSO module trips the drive and activates the STO function according to the application requirements.
 14. Make sure that the acknowledgement of the STO function is not possible before the motor is in safe state.
-

■ Validation of the SLS functions

Note: STO and SSE validation test must always be done before SLS or any other validation tests.

Follow these steps to validate all SLS functions (SLS1...4) that are used in the application. SLS1 is used as an example later in this section.

Note: If SLS4 limits are changed, this will have an impact on varSLS function also, which means that both of these functions must be validated.

1. Make sure that the input for the SLS1 function is wired and configured according to the wiring diagram.
2. Make sure that the SLS1 function is configured according to your design. For a configuration example, see section [Configuring SLS](#) on page 364. Check these settings:

Activation:

- [200.21 SLS1 activity and version](#)
- [SLSx.11 SLS1 input A](#)
- [SLSx.12 SLS1 input B](#) (only for SLS1).

Functionality for the SLS function:

- [200.22 SLS1 limit negative](#)
- [200.23 SLS1 limit positive](#)
- [SLSx.13 SLS1 trip limit negative](#)
- [SLSx.14 SLS1 trip limit positive.](#)

Acknowledgement:

- [SLSx.02 SLS acknowledgement](#)
- [FSOGEN.42 Acknowledgement button input](#) if manual acknowledgement is used.

Functionality:

a) with ramp monitoring:

- [SLSx.03 SLS activation monitoring method](#) = Ramp
- [200.202 SAR speed scaling](#)
- [200.112 SAR1 ramp time to zero](#)
- [SARx.02 SAR initial allowed range](#)
- [SARx.21 SAR1 min ramp time to zero](#)
- [SARx.22 SAR1 max ramp time to zero](#)
- drive parameter 23.23 emergency stop time, If [200.112 SAR1 ramp time to zero](#) = 0 ms.

OR

b) with time monitoring:

- *SLSx.03 SLS activation monitoring method = Time*
- drive parameter *23.13 deceleration time 1* (or *23.15 deceleration time 2*)
- *SLSx.04 SLS time delay.*

Indication:

- *SLSx.15 SLS1 output A*
- *SLSx.16 SLS1 output B* (only available for SLS1).

Test the SLS function as it is used in the application. Pay attention to the testing of the relevant fault situations for the application, for example, tripping fault in the drive, safety encoder fault, etc.

3. Start the drive and accelerate it to a suitable speed. Activate the SLS function with an FSO module input, or via the safety bus.

If you activate the function at a speed higher than the SLS limit (*200.23* or *200.22*), make sure that the deceleration ramp operates as required and no tripping fault occurs during the deceleration.

4. Make sure that SLS function limits the motor speed to the required limit. Give a speed reference higher than the SLS limit. Make sure that the drive does not follow speed references that are higher than the SLS limit.
5. Make sure that the SLS indication output (*SLSx.15* or *SLSx.16*) indicates safe speed when motor speed is within SLS limits.
6. Deactivate the SLS function. Make sure that the SLS indication (*SLSx.15* or *SLSx.16*) goes off, and the drive runs the motor according to the given user reference (outside the SLS speed limits).

Note: If the SLS function can be activated at a higher motor speed than the SLS limit (*200.23* or *200.22*), validate the correct operation as follows:

7. Activate SLS function at a motor speed above the SLS limit (*200.23* or *200.22*).
 8. Activate the coast stop of the drive.
 9. Make sure that the FSO module reacts according to your application requirements. For example, it trips the drive with the STO.
 10. Make sure that the following events occur only after the motor is in safe state:
 - the SLS indication (*SLSx.15*) goes on, if it is configured.
 - Acknowledgement of the stopping function (SSE or STO) is possible in case a stopping function was triggered earlier. See step [9](#).
-

■ Validation of the variable SLS function

Note: STO and SSE validation and PROFIsafe interface validation must always be done before SLS or any other validation tests.

Follow these steps to validate the variable SLS function:

1. Make sure that the input for the variable SLS function is configured in use in the safety PLC project.
2. Make sure that the variable SLS function is configured in the FSO module according to your design. For a configuration example, see section [Configuring Variable SLS](#) on page 368. Check these settings:

Activation:

- [200.61 SLS variable activity and version](#)

Functionality for the SLS function

- [200.52 SLS4 limit negative](#)
- [200.53 SLS4 limit positive](#)
- [SLSx.42 SLS4 trip limit negative](#)
- [SLSx.43 SLS4 trip limit positive](#)

Acknowledgement:

- [SLSx.02 SLS acknowledgement](#)
- [FSOGEN.42 Acknowledgement button input](#) if manual acknowledgement is used.

Functionality for the deceleration ramp:

a) with ramp monitoring:

- [SLSx.03 SLS activation monitoring method = Ramp](#)
- [200.202 SAR speed scaling](#)
- [200.112 SAR1 ramp time to zero](#)
- [SARx.02 SAR initial allowed range](#)
- [SARx.21 SAR1 min ramp time to zero](#)
- [SARx.22 SAR1 max ramp time to zero](#)
- drive parameter 23.23 *emergency stop time*, If [200.112](#) = 0 ms.

OR

b) with time monitoring:

- [SLSx.03 SLS activation monitoring method = Time](#)
- drive parameter 23.13 *deceleration time 1* (or 23.15 *deceleration time 2*)
- [SLSx.04 SLS time delay](#)

Indication:

- [SLSx.51 Variable SLS output](#)

3. Check from the safety PLC project that variable SLS scaling is set correctly.

Octet 3 for enabling the scaling:

- bit 6 negative scaling
- bit 7 positive scaling

Octets 4 and 5 for the variable SLS speed scaling value.

Test the variable SLS function as used in the application. Pay attention to the testing of the relevant fault situations for the application, for example the tripping fault in the drive, safety encoder fault, etc:

4. Start the drive with suitable speed reference. Activate the variable SLS function via the safety bus.
5. Make sure that the variable SLS function limits the motor speed to the required variable SLS limit by the application. Try to give a speed reference higher than the limit. Make sure that the drive does not follow speed references higher than the scaled SLS limit.
6. Make sure that *SLSx.51 Variable SLS output* indicates safe speed when motor speed is within the limits.
7. Scale down the variable SLS limit by various test scaling values.
8. Make sure that the deceleration ramp operates as required and no tripping fault occurs during the deceleration and that the reference SLS4 limits (100% scaling) are set according to the application requirements.
9. Make sure that *SLSx.51 Variable SLS output* indicates safe speed when motor speed is within the scaled variable SLS limits.
10. Deactivate variable SLS function. Make sure that the variable SLS indication goes off, and the drive runs the motor according to the given user reference.

Note: If the variable SLS function can be activated at a higher speed than the variable SLS limit, validate the correct operation as follows:

11. Activate the variable SLS function at a motor speed above the variable SLS limit (or scale down the variable SLS limit).
 12. Activate the coast stop of the drive.
 13. Make sure that the FSO module reacts according to your application requirements, for example, it trips the drive with the STO.
 14. Make sure that the following events occur only after the motor is in safe state:
 - SLS indication (*SLSx.51*) goes on, if it is configured.
 - Acknowledgement of the stopping function (SSE or STO) is possible in case a stopping function was triggered earlier. See step [13](#).
-

■ Validation of the SMS functions



WARNING! If the SMS validation is to be performed with the machinery coupled to the motor, make sure that the machinery is able to withstand the fast speed changes and the set maximum speed.

Validation of the SMS functions, version 1

1. Make sure that the SMS function is configured correctly according to your design. For a configuration example, see section [How to configure SMS, version 1](#) on page 376. Check these settings:

Activation:

- [200.71 SMS activity and version](#).

Functionality:

- [SMS.13 SMS trip limit negative](#)
- [SMS.13 SMS trip limit positive](#).

If possible, test the SMS trip limit in practice:

2. Make sure that you can run and stop the motor freely.
3. Start the drive and accelerate to a speed higher than [SMS.14 SMS trip limit positive](#).
4. Make sure that the FSO module detects the over speed and activates the SSE function.
5. Make sure that the SSE is configured according to the application safety requirements.
6. Make sure that the acknowledgement of the SSE function is only possible when the motor is in safe state.

Validation of the SMS function, version 2

1. Make sure that the SMS function is configured correctly according to your design. For a configuration example, see section [How to configure SMS, version 2](#) on page 377. Check these settings:

Activation:

- [200.71 SMS activity and version](#)

Functionality:

- [200.72 SMS limit negative](#)
 - [200.73 SMS limit positive](#)
 - [SMS.13 SMS trip limit negative](#)
 - [SMS.14 SMS trip limit positive](#)
-

2. Make sure that you can run and stop the motor freely.
 3. Start the drive and accelerate to a speed higher than the SMS limit positive ([200.73](#)).
 4. Make sure that SMS function limits the motor speed to the required limit by the application. Try to give a speed reference higher than the limit. Make sure that the drive does not follow speed reference if it is higher than the SMS limit. Repeat the test for both SMS limits (if in use in the application).
 5. Make sure that also SMS trip limits ([200.72](#), [200.73](#)) are set according to the application requirements. This procedure does not test the trip limits.
-

■ Validation of the POUS function

1. Make sure that the input and output(s) for the POUS function are configured according to the wiring diagram.
 2. Make sure that the POUS function is configured correctly according to your design. For a configuration example, see section [Configuring POUS](#) on page 378. Check these settings:
 - Activation:
 - [POUS.01 POUS activity and version](#)
 - [POUS.11 POUS input](#)
 - **Note:** activation can also come from the PROFIsafe.
 - Acknowledgement:
 - [POUS.02 POUS acknowledgement](#)
 - [FSOGEN.42 Acknowledgement button input](#) if the manual acknowledgement is used.
 - Functionality:
 - [POUS.13 POUS delay for completion](#).
 - Indication:
 - [POUS.21 POUS output](#)
 - [POUS.22 POUS completed output](#).
 6. Make sure that the motor is stopped.
 7. Activate the POUS function.
 8. Make sure that you cannot start the drive.
 9. Make sure that POUS output ([POUS.21](#)) activates immediately when POUS function is requested according to the system design.
 10. Make sure that the POUS indication lamp goes on according to the system design. The delay is defined by parameter POUS delay for completion ([POUS.13](#)).
 11. Make sure that you cannot start the drive.
 12. Deactivate the POUS function request and give acknowledgement signal if the manual acknowledgement is used.
 13. Make sure that the POUS output ([POUS.21](#)) and indication lamp goes off.
 14. Start the drive and make sure that the motor runs normally.
-

■ Validation of the SSM functions

Follow these steps to validate the SSM1...4 functions. Repeat the test procedure to all SSM functions that are in use. The SSM1 function is used later in this section as an example.

1. Make sure that the input and output(s) for the SSM function are configured according to the wiring diagram
2. Make sure that the SSM function is configured according to your design. For a configuration example, see section [Configuring SSM](#) on page 389. Check these settings:

Activation:

- [SSMx.01 SSM1 activity and version](#)
- [SSMx.11 SSM1 input](#).
- **Note:** Activation can also come from the PROFIsafe.

Functionality:

- [SSMx.13 SSM1 limit positive](#)
- [SSMx.12 SSM1 limit negative](#).

Indication:

- [SSMx.14 SSM1 output](#).

3. Make sure that you can run and stop the motor freely.
 4. Start the drive and accelerate the motor to a higher speed than the speed defined by [SSMx.13 SSM1 limit positive](#).
 5. Activate the SSM1 monitoring.
 6. Check that the status of the [SSMx.14 SSM1 output](#) is inactive until the motor speed is within the SSM1 limits.
 7. Give a speed reference that is lower than SSM1 limit.
 8. Check that the status of the [SSMx.14 SSM1 output](#) is active when motor speed is within SSM1 limits.
 9. If the motor can be rotated in the reverse direction, repeat the test procedure in the reverse direction.
-

■ Validation of the SDI function

Note: STO, SSE and safety encoder and encoder interface validation tests must always be done before SDI or any other validation tests.

Follow these steps to validate the SDI functions that are used in the application:

1. Make sure that the input for the SDI function is configured according to the wiring diagram
2. Make sure that the SDI function is configured according to your design. For a configuration example, see the section [Configuring SDI](#) on page 391. Check these settings:

Activation:

- [SDI.01 SDI version](#)
- [SDI.21 SDI positive input A](#)
- [SDI.22 SDI positive input B](#)
- [SDI.31 SDI negative input A](#)
- [SDI.32 SDI negative input B](#)
- **Note:** The activation can also come from the PROFIsafe.

Functionality for SDI function:

- [SDI.14 SDI tolerance limit degree](#)
- [SDI.02 SDI positive activity](#)
- [SDI.03 SDI negative activity](#).

Acknowledgement:

- [SDI.13 SDI acknowledgement](#)
- [FSOGEN.42 Acknowledgement button input](#) if the manual acknowledgement is used.

Functionality for the deceleration ramp:

- a) with ramp monitoring:
 - [SDI.10 SDI activation monitoring method](#) = Ramp
 - [200.202 SAR speed scaling](#)
 - [200.112 SAR1 ramp time to zero](#)
 - [SARx.02 SAR initial allowed range](#)
 - [SARx.21 SAR1 min ramp time to zero](#)
 - [SARx.22 SAR1 max ramp time to zero](#)
 - drive parameter 23.23 *emergency stop time*, if [200.112 SAR1 ramp time to zero](#) is = 0 ms

OR

b) with time monitoring:

- *SDI.10 SDI activation monitoring method* = Time
- drive parameter 23.13 *deceleration time 1* (or 23.15 *deceleration time 2*)
- *SDI.12 SDI delay*.

Indication:

- *SDI.23 SDI positive output A*
- *SDI.24 SDI positive output B*
- *SDI.33 SDI negative output A*
- *SDI.34 SDI negative output B*.

Test the SDI function as used in the application. Pay attention to testing of the relevant fault situations for the application, for example a fault in the drive, safety encoder fault, etc.

Check that the correct monitoring direction and limiting degree is configured according to the application.

Start the drive and make sure that you can run the motor in both directions if possible.

If the positive direction is your allowed direction, test the SDI function to the positive direction as described below. Otherwise do the validation test to the other direction by replacing all directions below to opposite values in the procedure.

1. Run motor to the positive direction.
 2. Activate SDI function to positive direction.
 3. Make sure that the SDI positive indication (*SDI.23*) activates.
 4. Stop the motor, or give 0 rpm user reference, and make sure that the motor shaft is stopped correctly and it is not crawling too much to the forbidden direction, and the SDI is not tripped to tolerance limit.
 5. Restart the drive to the positive user reference.
 6. Remove the positive SDI request.
 7. Acknowledge SDI function if manual acknowledgement is used.
 8. Activate the negative SDI request.
 9. Make sure that the motor decelerates as required and no tripping fault occurs during the deceleration.
 10. Make sure that the SDI negative indication (*SDI.33*) activates when the motor speed reaches zero rpm, or when the motor rotates to the allowed direction.
-

11. Make sure that you can run the motor only into the correct (negative) direction.

12. Deactivate the SDI negative request.

Repeat the same procedure for reverse SDI direction if it possible and if it is in use in your application.

■ Validation of the cascaded safety function

Without a PROFIsafe communication bus, you can cascade only safety functions which have a primary and a secondary digital input: STO, SS1, SSE, SLS1, SDI positive and SDI negative. Repeat the cascading validation procedure to all cascaded safety functions in your application.

This example shows how to validate the SSE function in a cascaded system (Cascade A) as shown in section [Cascade](#) on page 63.

1. Make sure that the cascaded safety function(s) are configured according to the wiring diagram.
2. Make sure that the cascaded safety functions are configured correctly according to your design. For a configuration example see chapter [How to configure a cascaded system](#) on page 324. Check these settings:

Master FSO:

- [SAFEIO.11 M/F mode for cascade](#)
- [SAFEIO.12 Cascade A](#)
- [STO.02 STO acknowledgement = automatic](#)
- [SSE.11 SSE input A](#)
- [SSE.12 SSE input B](#)
- [SSE.21 SSE output](#)
- [FSOGEN.42 Acknowledgement button input](#)

Follower FSO modules (check the settings in each follower FSO module in the cascade chain):

- [SAFEIO.11 M/F mode for cascade](#)
 - [STO.02 STO acknowledgement = Automatic](#)
 - [SSE.11 SSE input A](#) or [SSE.12 SSE input B](#)
 - [SSE.21 SSE output](#)
3. Activate cascaded safety function from the master FSO module.
 4. Check that the correct safety function is activated in the whole cascaded chain.
 5. Check that all cascaded safety functions are operating correctly according to the design in each of the cascaded FSO module.
 6. Deactivate cascaded safety functions from the master FSO, and acknowledge the safety function by using manual acknowledgement if in use.
 7. Check that the follower FSO modules are acknowledged.

Repeat this procedure for the Cascade B chain if in use.

Proof test intervals during operation

Proof tests are intended to ensure that the safety integrity of a safety system is maintained continuously and does not deteriorate over time. Proof tests are often required for mechanical brakes, for example. Proof tests are used mainly for parts of the system that cannot be automatically diagnosed.

The proof test interval is the interval between two proof tests. When the proof test interval has elapsed, the safety system has to be tested and restored to an "as new condition". The proof test must also be part of the regular maintenance plan.

For some of the components (electronics), the proof test interval is the same as the expected life time of the system.

A specific safety calculator software can assist in determining the requirements for the proof tests.

Residual risks

The safety functions are used to reduce the recognized hazardous conditions. In spite of this, it is not always possible to eliminate all potential hazards. Therefore the warnings for the residual risks must be given to the operators.

14

Fault tracing

Contents of this chapter

This chapter describes the status LEDs and provides generic diagnostics and troubleshooting tips for the FSO module related faults generated by the drive. It contains a list of the warning and fault messages with possible causes and corrective actions. The causes of most warnings and faults can be identified and corrected using the information in this chapter. If not, contact an ABB service representative.

Warnings and faults are listed in separate tables. Each table is sorted by warning/fault code.

Status LEDs

The status LEDs are situated on the front of the FSO module. The table below describes the status LED indications.

| LED | LED off | LED on and steady | | LED flashing | |
|--------------|--|-------------------|--|--------------|---|
| POWER | No power | Green | Power to the FSO is on. | - | - |
| RUN | FSO is in the Fail-safe mode and Safe state (STO activated). | Green | FSO is in the Operational or Safe state. | Green | FSO is in the Configuration or Start-up mode. |
| STATUS/FAULT | The drive is in normal operation, without active safety functions and no faults. | Green | A safety function is active. | Green | Request for a safety function has ended but it has not been acknowledged. |
| | | Red | FSO is in the Fail-safe mode. | Red | FSO is in the Configuration mode (RUN LED is also blinking). |

| LED | LED off | LED on and steady | | LED flashing | |
|-----|--|-------------------|---|--------------|--|
| STO | The drive STO circuit is closed and the drive is in operation. | Green | The drive STO circuit is open. | - | - |
| FB | Safety communication to the fieldbus has stopped. | Green | FSO is ready to start safety communication to the fieldbus. | Green | Safety communication to the fieldbus is running. |

Event types

The FSO module generates three types of events to the drive:

- Pure events, which are just informative data
- Warnings, which are shown to the user
- Faults, which stop the drive and are shown to the user.

Warnings do not need to be reset; they stop showing when the cause of the warning ceases. Warnings will not trip the drive and the drive will continue to run the motor. Faults cause the drive to trip and the motor to stop. For information on how to recover from a fault, see section [FSO recovery](#) on page 506.

The user can select the event type (warning, fault or event) for certain function requests, limit hits and special events:

- Parameter [FSOGEN.61 STO indication ext request](#) defines the event type for the STO, SS1 and SSE function external requests. The same parameter also defines the event type that the FSO module generates when the function is completed.
- Parameter [FSOGEN.62 STO indication safety limit](#) defines the event type for the limit hits of:
 - SLS1, ..., SLS4, Variable SLS, SMS and SDI functions
 - ramp monitoring and time monitoring of the safety ramps SAR0 and SAR1.
- Parameter [SBUSGEN.10 STO indication passivation](#) defines the event type for the FSO module passivation due to safety fieldbus problems.

Event code decoding with Drive Composer pro PC tool

Check the reason for the event from the event log of the Drive Composer PC tool by keeping the mouse over the AUX-code. For additional information, see the table below.

Faults, warnings and events

| Code (hex) | Name | Cause | What to do | |
|---------------|----------------------|---|--|-------|
| Faults | | | | |
| 7A81 | TUCSO fault | FSO subsystem fault | Contact your local ABB representative. | |
| 7A8B | FSO general fault | FSO module is in the Configuration mode.
FSO module also generates this fault after certain malfunctions which the FSO module indicates by warnings. First the FSO module generates a warning indication which allows the drive to control the system to a safe state. After this the drive trips. | See the warning log for more information on the actual cause. | 3) |
| 7A90 | FSO stop completed | FSO module has completed the STO, SS1 or SSE function. | - | 1) |
| 7A91 | FSO safe speed limit | FSO module detected an SLS or SMS speed trip limit violation. | Check the separate code related to SLS and SMS functions.
See section User-selectable events for limit hits and special events on page 503. | 2) 3) |
| 7A92 | FSO out of eme ramp | Motor speed was not inside the ramp window during the SSE function. | Make sure that the drive can decelerate the load using the ramp time (200.102 SAR0 ramp time to zero). | 2) |
| 7A93 | FSO ramp coasted | Drive coasted the motor to stop instead of using the ramp. | Check that the FSO module speed limit for stopping the ramp deceleration is not excessive (FSOGEN.51 Zero speed without encoder). | 2) |
| 7A94 | FSO out of safe ramp | Motor speed was not inside the ramp window during the SS1 function. | Make sure that the drive can decelerate the load using the ramp time (200.112 SAR1 ramp time to zero). | 2) |
| 7A96 | FSO out of SDI | SDI positive or SDI negative exceeded the tolerance limit to the forbidden direction. | Make sure that SDI tolerance values are defined properly.
Check limits of the drive. For example, see the usage of DC hold from the drive firmware manual. | 2) |

| Code (hex) | Name | Cause | What to do | |
|-----------------|---------------------------|--|--|-------|
| 7A97 | FSO premature POUS | FSO received an external POUS request while the drive was still modulating. | It is recommended to activate the POUS function only when the drive is stopped. | |
| 7A98 | FSO undefined fault | FSO new version, undefined fault in the dive event system. | Contact your local ABB representative. | |
| 7A99 | FSO passivated | FSO module was passivated due to safety fieldbus problems. | Check the fieldbus connection and fieldbus controller for passivation cause. | 5) |
| Warnings | | | | |
| A7D0 | FSO general warnings | Warning from the FSO module, for example: <ul style="list-style-type: none"> • acknowledgement button not operated correctly • I/O redundancy fault • safety relay feedback fault • motor speed from the safety encoder lost | See the tips in the Drive Composer PC tool. | 3) |
| A7D1 | FSO internal fault | Internal fault in the FSO module | Reboot the FSO module. If the problem still exists, replace the FSO module. Contact your local ABB representative. | 5) 3) |
| A7D2 | FSO IO fault | Problems in the I/O cabling or safety relays | Check the FSO I/O cabling. | 4) 3) |
| A7D3 | FSO STO fault | Problems in the STO cabling or inside the drive | Check the FSO STO cabling. | 4) |
| A7D4 | FSO STO request | FSO module received an external STO request. | - | 1) |
| A7D5 | FSO communication fault | Fault in FSO communication | Check all connections. | 4) 3) |
| A7D6 | FSO safety fieldbus fault | Fault in FSO safety fieldbus communication | Check all connections. | 4) 3) |
| A7D7 | FSO configuration fault | Fault in FSO configuration | Check the FSO module parameter settings using Drive Composer pro. | 4) |
| A7D8 | FSO safety encoder fault | Fault in the safety encoder connected to the FSE module | Check the safety encoder and the connections and parameter settings. | |

| Code (hex) | Name | Cause | What to do | |
|------------|-----------------------|---|--|-------|
| A7D9 | FSO encoderless fault | Speed estimates differ too much. | <ul style="list-style-type: none"> • Check the behavior of the driven load compared with the drive control parameter settings. • Check that the drive is suitable for the drive train and the motor. • Adapt control parameters if gear play or torsional rigidity causes problems. | 4) |
| A7DA | FSO temperature fault | FSO module temperature is too high. | <ul style="list-style-type: none"> • Check ambient conditions. Reboot the FSO module (switch the power off and on or use drive parameter <i>96.09 FSO reboot</i>, see the drive firmware manual). • Make sure that cooling is sufficient. Contact your local ABB representative. | 4) |
| A7DB | FSO undefined warning | FSO new version, undefined warning in the drive event system. | Contact your local ABB representative. | |
| AA90 | FSO stop completed | FSO module has completed the STO, SS1 or SSE function. | - | 1) |
| AA91 | FSO safe speed limit | FSO module detected an SLS or SMS speed trip limit violation. | Check the separate code related to SLS and SMS functions.
See section <i>User-selectable events for limit hits and special events</i> on page 503. | 2) 3) |
| AA92 | FSO out of eme ramp | Motor speed was not inside the ramp window during the SSE function. | Make sure that the drive can decelerate the load using the ramp time (<i>200.102 SAR0 ramp time to zero</i>). | 2) |
| AA93 | FSO ramp coasted | Drive coasted the motor to stop instead of using the ramp. | Check that the FSO module zero speed limit for the deceleration ramp is not excessive (<i>FSOGEN.51 Zero speed without encoder</i> or <i>FSOGEN.52 Zero speed with encoder</i>). | 2) |
| AA94 | FSO out of safe ramp | Motor speed was not inside the ramp window during the SS1 function. | Make sure that the drive can decelerate the load using the ramp time (<i>200.112 SAR1 ramp time to zero</i>). | 2) |

| Code (hex) | Name | Cause | What to do | |
|------------|------------------|---|---|-------|
| AA96 | FSO out of SDI | SDI positive or SDI negative exceeded the tolerance limit to the forbidden direction. | Make sure that SDI tolerance values are defined properly.
Check limits of the drive. For example, see the usage of DC hold from the drive firmware manual. | 2) |
| AA97 | FSO POUS request | FSO module received an external POUS request and activated POUS. | - | |
| AA99 | FSO passivated | FSO module was passivated due to safety fieldbus problems. | Check the fieldbus connection and fieldbus controller for passivation cause. | 5) |
| AAA1 | FSO STO request | FSO module received an external STO request. | - | 1) |
| AAA2 | FSO SSE request | FSO module received an external SSE request. | - | 1) |
| AAA3 | FSO SS1 request | FSO module received an external SS1 request. | - | 1) |
| AAA4 | FSO SLS1 hit | FSO module detected an SLS1 speed trip limit violation. | Investigate the reason for trip from the application point of view. If application is OK, then make sure that SLS is configured properly.
Make sure that SLS trip limits are defined properly.
Check that mute time values are defined properly (FSOGEN.31 or SLSx.17 if enabled, and FSOGEN.33). | 2) 6) |
| AAA5 | FSO SLS2 hit | FSO module detected an SLS2 speed trip limit violation. | Investigate the reason for trip from the application point of view. If application is OK, then make sure that SLS is configured properly.
Make sure that SLS trip limits are defined properly.
Check that mute time values are defined properly (FSOGEN.31 or SLSx.27 if enabled, and FSOGEN.33). | 2) 6) |

| Code (hex) | Name | Cause | What to do | |
|------------|----------------------|---|---|-------|
| AAA6 | FSO SLS3 hit | FSO module detected an SLS3 speed trip limit violation. | Investigate the reason for trip from the application point of view. If application is OK, then make sure that SLS is configured properly.
Make sure that SLS trip limits are defined properly.
Check that mute time values are defined properly (FSOGEN.31 or SLSx.37 if enabled, and FSOGEN.33). | 2) 6) |
| AAA7 | FSO SLS4 hit | FSO module detected an SLS4 speed trip limit violation. | Investigate the reason for trip from the application point of view. If application is OK, then make sure that SLS is configured properly.
Make sure that SLS trip limits are defined properly.
Check that mute time values are defined properly (FSOGEN.31 or SLSx.47 if enabled, and FSOGEN.33). | 2) 6) |
| AAA8 | FSO SMS hit | FSO module detected an SMS speed trip limit violation. | Investigate the reason for trip from the application point of view. If application is OK, then make sure that SMS is configured properly.
Make sure that SMS trip limits are defined properly.
Check that mute time values are defined properly (FSOGEN.31 or SMS.17 if enabled). | 2) 6) |
| AAA9 | FSO SAR0 hit | FSO module detected an SAR0 limit violation. | Make sure that the drive can decelerate the load using the ramp time (200.102 SAR0 ramp time to zero). | 2) |
| AAAA | FSO SAR1 hit | FSO module detected an SAR1 limit violation. | Make sure that the drive can decelerate the load using the ramp time (200.112 SAR1 ramp time to zero). | 2) |
| AAB0 | FSO SDI positive hit | SDI positive exceeded the tolerance limit to the forbidden direction. | Make sure that SDI tolerance values are defined properly.
Check limits of the drive. For example, see the usage of DC hold from the drive firmware manual. | 2) |

| Code (hex) | Name | Cause | What to do | |
|------------|-------------------------|--|---|-------|
| AAB1 | FSO SDI negative hit | SDI negative exceeded the tolerance limit to the forbidden direction. | Make sure that SDI tolerance values are defined properly.
Check limits of the drive. For example, see the usage of DC hold from the drive firmware manual. | 2) |
| AAB2 | FSO ramp time hit | FSO module detected a violation of a time monitored ramp. | Make sure that the drive can decelerate the load within the time defined for ramp time monitoring. <ul style="list-style-type: none"> • Check the drive ramp time settings. • Check that the drive can in fact accomplish the deceleration along the ramp defined. Make sure that the limit for ramp time monitoring of the FSO module exceeds the actual drive ramp time. The parameter varies depending on the safety function. For the SS1 function it is SS1.14 SS1-t delay for STO . | 2) |
| AAB3 | FSO zero spd hit | Drive speed rushed during zero speed delay (SSE.16 SSE ramp zero speed delay for STO or SS1.15 SS1-r ramp zero speed delay for STO). | Check the drive. | 2) |
| AAB4 | FSO speed sync fail | FSO module detected a difference between the two monitored motor speed values (200.01 FSO speed ch1 and 200.02 FSO speed ch2). | Restart the drive and FSO module. | 2) |
| AAB5 | FSO varSLS hit | FSO module detected a Variable SLS speed trip limit violation. | Investigate the reason for trip from the application point of view. If application is OK, then make sure that Variable SLS is configured properly.
Make sure that Variable SLS trip limits are defined properly.
Check that mute time values are defined properly (FSOGEN.31 or SLsX.57 if enabled, and FSOGEN.33). | 2) 6) |
| AAB6 | FSO safebus passivation | FSO module was passivated due to communication problems. | Check the fieldbus connection and fieldbus controller for passivation cause. | 5) |

| Code (hex) | Name | Cause | What to do | |
|---------------|----------------------|---|--|-------|
| Events | | | | |
| B790 | FSO general event | FSO module generated an event other than a fault or a warning. | See the tips in the Drive Composer PC tool. | 3) |
| B792 | FSO undefined event | FSO new version, undefined event in the drive event system. | Contact your local ABB representative. | |
| B793 | FSE Ch1 diag event | Encoder failure. | Check the encoder. In case of an encoder event <i>A7E1 Encoder warning</i> exists in the drive event log, fix the encoder fault. FSO module reset is also needed if the FSO module is in the Fail safe mode. | |
| B794 | FSE Ch2 diag event | Encoder failure. | Check the encoder. In case of an encoder event <i>A7E1 Encoder warning</i> exists in the drive event log, fix the encoder fault. FSO module reset is also needed if the FSO module is in the Fail safe mode. | |
| BA90 | FSO stop completed | FSO module has completed the STO, SS1 or SSE function. | - | 1) |
| BA91 | FSO safe speed limit | FSO module detected an SLS or SMS speed trip limit violation. | Check the separate code related to SLS and SMS functions.
See section <i>User-selectable events for limit hits and special events</i> on page 503. | 2) 3) |
| BA92 | FSO out of eme ramp | Motor speed was not inside the ramp window during the SSE function. | Make sure that the drive can decelerate the load using the ramp time (<i>200.102 SAR0 ramp time to zero</i>). | 2) |
| BA93 | FSO ramp coasted | Drive coasted the motor to stop instead of using the ramp. | Check that the FSO module zero speed limit for the deceleration ramp is not excessive (<i>FSOGEN.51 Zero speed without encoder</i> or <i>FSOGEN.52 Zero speed with encoder</i>). | 2) |
| BA94 | FSO out of safe ramp | Motor speed was not inside the ramp window during the SS1 function. | Make sure that the drive can decelerate the load using the ramp time (<i>200.112 SAR1 ramp time to zero</i>). | 2) |

| Code (hex) | Name | Cause | What to do | |
|------------|-----------------|---|---|-------|
| BA96 | FSO out of SDI | SDI positive or SDI negative exceeded the tolerance limit to the forbidden direction. | Make sure that SDI tolerance values are defined properly.
Check limits of the drive. For example, see the usage of DC hold from the drive firmware manual. | |
| BA99 | FSO passivated | FSO module was passivated due to safety fieldbus problems. | Check the fieldbus connection and fieldbus controller for passivation cause. | 5) |
| BAA1 | FSO STO request | FSO module received an external STO request. | - | 1) |
| BAA2 | FSO SSE request | FSO module received an external SSE request. | - | 1) |
| BAA3 | FSO SS1 request | FSO module received an external SS1 request. | - | 1) |
| BAA4 | FSO SLS1 hit | FSO module detected an SLS1 speed trip limit violation. | Investigate the reason for trip from the application point of view. If application is OK, then make sure that SLS is configured properly.
Make sure that SLS trip limits are defined properly.
Check that transient mute time values are defined properly (FSOGEN.31 or SLSx.17 if enabled, and FSOGEN.33). | 2) 6) |
| BAA5 | FSO SLS2 hit | FSO module detected an SLS2 speed trip limit violation. | Investigate the reason for trip from the application point of view. If application is OK, then make sure that SLS is configured properly.
Make sure that SLS trip limits are defined properly.
Check that transient mute time values are defined properly (FSOGEN.31 or SLSx.27 if enabled, and FSOGEN.33). | 2) 6) |
| BAA6 | FSO SLS3 hit | FSO module detected an SLS3 speed trip limit violation. | Investigate the reason for trip from the application point of view. If application is OK, then make sure that SLS is configured properly.
Make sure that SLS trip limits are defined properly.
Check that transient mute time values are defined properly (FSOGEN.31 or SLSx.37 if enabled, and FSOGEN.33). | 2) 6) |

| Code (hex) | Name | Cause | What to do | |
|------------|----------------------|---|---|-------|
| BAA7 | FSO SLS4 hit | FSO module detected an SLS4 speed trip limit violation. | Investigate the reason for trip from the application point of view. If application is OK, then make sure that SLS is configured properly.
Make sure that SLS trip limits are defined properly.
Check that transient mute time values are defined properly (FSOGEN.31 or SLSx.47 if enabled, and FSOGEN.33). | 2) 6) |
| BAA8 | FSO SMS hit | FSO module detected an SMS speed trip limit violation. | Investigate the reason for trip from the application point of view. If application is OK, then make sure that SMS is configured properly.
Make sure that SMS trip limits are defined properly.
Check that transient mute time values are defined properly (FSOGEN.31 or SMS.17 if enabled). | 2) 6) |
| BAA9 | FSO SAR0 hit | FSO module detected an SAR0 limit violation. | Make sure that the drive can decelerate the load using the ramp time (200.102 SAR0 ramp time to zero). | 2) |
| BAAA | FSO SAR1 hit | FSO module detected an SAR1 limit violation. | Make sure that the drive can decelerate the load using the ramp time (200.112 SAR1 ramp time to zero). | 2) |
| BAB0 | FSO SDI positive hit | SDI positive exceeded the tolerance limit to the forbidden direction. | Make sure that SDI tolerance values are defined properly.
Check limits of the drive. For example, see the usage of DC hold from the drive firmware manual. | 2) |
| BAB1 | FSO SDI negative hit | SDI negative exceeded the tolerance limit to the forbidden direction. | Make sure that SDI tolerance values are defined properly.
Check limits of the drive. For example, see the usage of DC hold from the drive firmware manual. | 2) |

| Code (hex) | Name | Cause | What to do | |
|------------|-------------------------|--|--|-------|
| BAB2 | FSO ramp time hit | FSO module detected a violation of a time monitored ramp. | <p>Make sure that the drive can decelerate the load within the time defined for ramp time monitoring.</p> <ul style="list-style-type: none"> • Check the drive ramp time settings. • Check that the drive can in fact accomplish the deceleration along the ramp defined. <p>Make sure that the limit for ramp time monitoring of the FSO module exceeds the actual drive ramp time. The parameter varies depending on the safety function. For the SS1 function it is SS1.14 SS1-t delay for STO.</p> | 2) |
| BAB3 | FSO zero spd hit | Drive speed rushed during zero speed delay (SSE.16 SSE ramp zero speed delay for STO or SS1.15 SS1-r ramp zero speed delay for STO). | Check the drive. | 2) |
| BAB4 | FSO speed sync fail | FSO module detected a difference between the two monitored motor speed values (200.01 FSO speed ch1 and 200.02 FSO speed ch2). | Restart the drive and FSO module. | 2) |
| BAB5 | FSO varSLS hit | FSO module detected a Variable SLS speed trip limit violation. | <p>Investigate the reason for trip from the application point of view. If application is OK, then make sure that Variable SLS is configured properly.</p> <p>Make sure that Variable SLS trip limits are defined properly.</p> <p>Check that transient mute time values are defined properly (FSOGEN.31 or SLSx.57 if enabled, and FSOGEN.33).</p> | 2) 6) |
| BAB6 | FSO safebus passivation | FSO module was passivated due to communication problems. | Check the fieldbus connection and fieldbus controller for passivation cause. | 5) |

¹⁾ This is a user-selectable event for a function request. See parameter [FSOGEN.61 STO indication ext request](#) and section [User-selectable events for function requests](#) on page 503.

²⁾ This is a user-selectable event for a limit hit or a special event. See parameter [FSOGEN.62 STO indication safety limit](#) and section [User-selectable events for limit hits and special events](#) on page 503.

³⁾ For more information, see the tips in the Drive Composer PC tool.

⁴⁾ This warning indicates a fault actually. However, the FSO module generates a warning indication first to

allow the drive to control the system to a safe state. When the system is in the safe state, the drive trips. Fault indication is [7A8B FSO general fault](#).

⁵⁾ This is a user-selectable event for a safety fieldbus failure. See parameter [SBUSGEN.10 STO indication passivation](#) and section [User-selectable events for safety fieldbus failures](#) on page 506.

⁶⁾ See section [Configuring mute times](#) on page 395.

■ User-selectable events for function requests

The table below lists the user-selectable events related to function requests.

| Function/
Incident | Events depending on
the event type selection (parameter FSOGEN.61) | | |
|-----------------------|--|---|---|
| | Fault | Warning | Event |
| STO function | | | |
| STO request | AAA1 FSO STO request
(warning) ¹⁾ | AAA1 FSO STO request | BAA1 FSO STO request |
| STO completed | 7A90 FSO stop completed | AA90 FSO stop completed | BA90 FSO stop completed |
| SS1 function | | | |
| SS1 request | AAA3 FSO SS1 request
(warning) ¹⁾ | AAA3 FSO SS1 request | BAA3 FSO SS1 request |
| SS1 completed | 7A90 FSO stop completed | AA90 FSO stop completed | BA90 FSO stop completed |
| SSE function | | | |
| SSE request | AAA2 FSO SSE request
(warning) ¹⁾ | AAA2 FSO SSE request | BAA2 FSO SSE request |
| SSE completed | 7A90 FSO stop completed | AA90 FSO stop completed | BA90 FSO stop completed |

¹⁾ If you select Fault for parameter [FSOGEN.61 STO indication ext request](#), the FSO module generates a warning at the function request, and a fault trip only after the function is completed. The fault trip is delayed because the drive must be able to control the system to the Safe state first.

Note: If you select None for parameter [FSOGEN.61 STO indication ext request](#), the FSO module generates no event when it receives a function request or detects that the function is completed.

■ User-selectable events for limit hits and special events

The table below lists user-selectable events related to limit hits and special events.

| Limit/Incident | Events depending on
the event type selection (parameter FSOGEN.62) | | |
|----------------------|--|---|---|
| | Fault | Warning | Event |
| SLS1 | | | |
| SLS1 limit hit | AAA4 FSO SLS1 hit
(warning) ¹⁾ | AAA4 FSO SLS1 hit | BAA4 FSO SLS1 hit |
| System at safe state | 7A91 FSO safe speed limit | AA91 FSO safe speed limit | BA91 FSO safe speed limit |

| Limit/Incident | Events depending on the event type selection (parameter <i>FSOGEN.62</i>) | | |
|----------------------|--|----------------------------------|----------------------------------|
| | Fault | Warning | Event |
| SLS2 | | | |
| SLS2 limit hit | <i>AAA5 FSO SLS2 hit (warning)¹⁾</i> | <i>AAA5 FSO SLS2 hit</i> | <i>BAA5 FSO SLS2 hit</i> |
| System at safe state | <i>7A91 FSO safe speed limit</i> | <i>AA91 FSO safe speed limit</i> | <i>BA91 FSO safe speed limit</i> |
| SLS3 | | | |
| SLS2 limit hit | <i>AAA6 FSO SLS3 hit (warning)¹⁾</i> | <i>AAA6 FSO SLS3 hit</i> | <i>BAA6 FSO SLS3 hit</i> |
| System at safe state | <i>7A91 FSO safe speed limit</i> | <i>AA91 FSO safe speed limit</i> | <i>BA91 FSO safe speed limit</i> |
| SLS4 | | | |
| SLS4 limit hit | <i>AAA7 FSO SLS4 hit (warning)¹⁾</i> | <i>AAA7 FSO SLS4 hit</i> | <i>BAA7 FSO SLS4 hit</i> |
| System at safe state | <i>7A91 FSO safe speed limit</i> | <i>AA91 FSO safe speed limit</i> | <i>BA91 FSO safe speed limit</i> |
| Variable SLS | | | |
| varSLS limit hit | <i>AAB5 FSO varSLS hit (warning)¹⁾</i> | <i>AAB5 FSO varSLS hit</i> | <i>BAB5 FSO varSLS hit</i> |
| System at safe state | <i>7A91 FSO safe speed limit</i> | <i>AA91 FSO safe speed limit</i> | <i>BA91 FSO safe speed limit</i> |
| SMS | | | |
| SMS limit hit | <i>AAA8 FSO SMS hit (warning)¹⁾</i> | <i>AAA8 FSO SMS hit</i> | <i>BAA8 FSO SMS hit</i> |
| System at safe state | <i>7A91 FSO safe speed limit</i> | <i>AA91 FSO safe speed limit</i> | <i>BA91 FSO safe speed limit</i> |
| SDI positive | | | |
| SDI positive hit | <i>AAB0 FSO SDI positive hit (warning)¹⁾</i> | <i>AAB0 FSO SDI positive hit</i> | <i>BAB0 FSO SDI positive hit</i> |
| System at safe state | <i>7A96 FSO out of SDI</i> | <i>AA96 FSO out of SDI</i> | <i>BA96 FSO out of SDI</i> |
| SDI negative | | | |
| SDI negative hit | <i>AAB1 FSO SDI negative hit (warning)¹⁾</i> | <i>AAB1 FSO SDI negative hit</i> | <i>BAB1 FSO SDI negative hit</i> |
| System at safe state | <i>7A96 FSO out of SDI</i> | <i>AA96 FSO out of SDI</i> | <i>BA96 FSO out of SDI</i> |

| Limit/Incident | Events depending on the event type selection (parameter <i>FSOGEN.62</i>) | | |
|--------------------------------------|--|---------------------------------|---------------------------------|
| | Fault | Warning | Event |
| SAR0 | | | |
| SAR0 limit hit | <i>AAA9 FSO SAR0 hit (warning)¹⁾</i> | <i>AAA9 FSO SAR0 hit</i> | <i>BAA9 FSO SAR0 hit</i> |
| System at safe state | <i>7A92 FSO out of eme ramp</i> | <i>AA92 FSO out of eme ramp</i> | <i>BA92 FSO out of eme ramp</i> |
| SAR1 | | | |
| SAR1 limit hit | <i>AAAA FSO SAR1 hit (warning)¹⁾</i> | <i>AAAA FSO SAR1 hit</i> | <i>BAAA FSO SAR1 hit</i> |
| System at safe state | <i>7A92 FSO out of eme ramp</i> | <i>AA92 FSO out of eme ramp</i> | <i>BA92 FSO out of eme ramp</i> |
| Ramp time hit | | | |
| Ramp time hit | <i>AAB2 FSO ramp time hit (warning)¹⁾</i> | <i>AAB2 FSO ramp time hit</i> | <i>BAB2 FSO ramp time hit</i> |
| System at safe state | <i>7A92 FSO out of eme ramp</i> | <i>AA92 FSO out of eme ramp</i> | <i>BA92 FSO out of eme ramp</i> |
| Zero speed hit | | | |
| Zero speed hit | <i>AAB3 FSO zero spd hit (warning)¹⁾</i> | <i>AAB3 FSO zero spd hit</i> | <i>BAB3 FSO zero spd hit</i> |
| System at safe state | <i>7A92 FSO out of eme ramp</i> | <i>AA92 FSO out of eme ramp</i> | <i>BA92 FSO out of eme ramp</i> |
| Speed values not in synchrony | | | |
| Speeds not in sync. | <i>AAB4 FSO speed sync fail (warning)¹⁾</i> | <i>AAB4 FSO speed sync fail</i> | <i>BAB4 FSO speed sync fail</i> |
| System at safe state | <i>7A90 FSO stop completed</i> | <i>AA90 FSO stop completed</i> | <i>BA90 FSO stop completed</i> |

¹⁾ If you select Fault for parameter *FSOGEN.62 STO indication safety limit*, the FSO module generates a warning at the limit hit, and a fault only after the system is at the Safe state.

Note: If you select None for parameter *FSOGEN.62 STO indication safety limit*, the FSO module generates no event when it detects a limit hit.

■ User-selectable events for safety fieldbus failures

The table below lists user-selectable events related to safety fieldbus failures.

| Incident | Events depending on the event type selection (parameter <i>SBUSGEN.10</i>) | | |
|--|---|-------------------------------------|-------------------------------------|
| | Fault | Warning | Event |
| Problem in the safety fieldbus communication | <i>AAB6 FSO safebus passivation</i> (warning) ¹⁾ | <i>AAB6 FSO safebus passivation</i> | <i>BAB6 FSO safebus passivation</i> |
| System at safe state | <i>7A99 FSO passivated</i> | <i>AA99 FSO passivated</i> | <i>BA99 FSO passivated</i> |

¹⁾ If you select Fault for parameter *SBUSGEN.10 STO indication passivation*, the FSO module generates a warning at the passivation, and a fault only after the system is at the Safe state.

Note: If you select None for parameter *SBUSGEN.10 STO indication passivation*, the FSO module generates no event when it detects a failure in the safety fieldbus communication.

Auxiliary codes

Faults, warnings and events have 32-bit auxiliary codes, which help in finding the problem. See the tips in the Drive Composer PC tool for more information on the auxiliary codes.

FSO recovery

■ External fault

An external fault in a safety circuit can lead either to safe state or fail-safe state activation in FSO module. Safe state means STO activation with software indication according to *Faults, warnings and events* table on page 493. Resetting the drive is needed before resuming normal operation.

With fail-safe state, STO is activated and a relevant fault code is shown, and in this case, drive reset and FSO reboot are required before resuming normal operation.

If FSO enters the fail-safe state because of external fault that can be repaired, resuming to normal operation can take place after FSO reboot. The steps for recovering from the fault situation are as follows:

1. Check the reason for the event from the Drive Composer event log.
2. Repair the cause of the fault. See the instructions in section *Faults, warnings and events* on page 493.
3. Reboot the FSO with one of the methods below:
 - Disconnect the X112 connector and reconnect it (power off and on), or
 - Use the **Reboot FSO** button in the Drive Composer pro PC tool (Safety settings), or

- Use the drive parameter *96.09 FSO reboot* (with Drive Composer or control panel).

Note: The FSO accepts a 'soft boot' if it is in Fail-safe mode and the motor is stopped.

If necessary, also reset the fault in the drive using the control panel (by pressing the Reset button) or the Drive Composer pro PC tool, or through the fieldbus.

Note: When using FSO with an FSE and a safety encoder: if an internal safety encoder failure occurs, the safety encoder goes into a safe state. To recover from these situations, you may have to reboot the safety encoder (for example, by switching the power off and on).

If FSO is not recovering from the fault, contact your local ABB representative.

■ Internal fault

If there is an internal fault in FSO or FSE module that leads to a permanent defect, the module must be replaced. The FSO and FSE modules are not repairable.

Reporting problems and failures

If you detect a failure in the safety module or safety function that prevents FSO fault recovery, contact your local ABB representative. Provide the support package file of your configuration and the safety file of the FSO module. For more information, see the Drive Composer pro PC tool manual.

15

Maintenance

Contents of this chapter

This chapter contains maintenance information related to the FSO module:

- instructions for component replacement in the safety circuit (for example, replacement of the FSO or FSE module, control unit, memory unit, power unit, or FB module)
- how to reset the FSO module to factory settings
- how to recover the FSO module from fail-safe mode
- information about updates to the safety system
- information about proof tests.



WARNING! Obey the instructions in chapter [Safety instructions](#). If you ignore them, injury or death, or damage to the equipment can occur.

Planning

All maintenance and repair actions on a safety critical system must be planned, performed and documented accordingly.

Tools

You need the Drive Composer pro PC tool to perform the maintenance procedures.

Component replacement in the safety circuit



WARNING! During maintenance and repair, if the FSO module is removed, the functional safety of the machinery must be ensured by other means.

Note: If the FSO module fails to operate, you have to replace it with a new one. The module is not repairable. Remember to make a backup of the safety configuration file during the first commissioning and after the successfully performed validation tests for the safety functions.

Note: When the FSO module is in the Fail-safe mode, it can be recovered by a reboot. See section [FSO recovery](#) on page [506](#) for rebooting instructions.

■ Before component replacement



WARNING! Read and obey the instructions in chapter [Safety instructions](#). If you ignore them, injury or death, or damage to the equipment can occur.

1. Stop the driven machinery and prevent an unexpected start-up.
2. Upload the FSO parameters from the FSO to the Drive Composer pro PC tool and save the safety file. If this is not possible, use a backup from a previous commissioning.
3. Disconnect the supply with the supply disconnecting device. For instructions on how to do this safely, see the drive hardware manual.

■ Replacing the FSO module



WARNING: Do not bypass the FSO module, or the safety functions of the FSO module under any circumstances.

1. Disconnect IO wiring, data cable and STO cable and remove the FSO module.
 2. Mark clearly on the FSO module that it is decommissioned.
 3. Install the new FSO module and wiring according to chapter Installation.
 4. Download the FSO parameters from the Drive Composer pro PC tool to the FSO according to chapter [Configuration](#) on page [309](#).
 5. If you are updating the module from revision G (or earlier) to revision H (or later), there are new parameters that you must set. See [SLsX.05](#) and [SLsX.06](#) on page
-

[425](#). If you download an old configuration, the new parameters will get the default values. It is recommended to download, upload, and check the parameters.

6. Update the revision and the serial number of the new FSO module to the logbook of the driven machine.

■ **Reinstalling the FSO module to another drive**

1. Install the FSO module and wiring to the new drive according to chapter [Installation](#) on page [297](#).
2. Restore the drive parameter backup if available.
3. Download the correct safety configuration file to the spare part FSO module.

■ **Replacing the control unit of the drive**

1. Replace the control unit.
2. Install the FSO module and connect data and STO cables to the control unit. Connect FSO IO connectors and power supply connector.
3. Restore the drive configuration:
 - install the previously used memory unit to the new control unit, or
 - install a new memory unit, read the configuration from FSO and restore it to the control unit with Drive Composer pro.
4. Do the start-up and validation procedures. See section [Start-up and validation test](#) on page [512](#).

■ **Replacing the memory unit or updating the firmware of the drive**

1. Backup the drive parameter settings, if possible.
2. Download the drive firmware to the memory unit.
3. Restore drive parameter backup, if available.
4. Reboot the FSO module.
5. Reset the drive.
6. Upload and download the FSO configuration file if the drive firmware is updated from an older version than 2.60.

■ **Replacing a power unit, or its circuit boards or wirings**

1. Replace the relevant part or power unit.
 2. Do the start-up and validation procedures. See section [Start-up and validation test](#) on page [512](#).
-

■ Replacing the FB module in PROFIsafe network

1. Replace the FB module according to the instructions in *FPNO-21 PROFINET fieldbus adapter module user's manual* (3AXD50000158614 [English]), or *FENA-01/-11/-21 Ethernet adapter module user's manual* (3AUA0000093568 [English]).
2. Assign the device name for the FB module from the safety PLC (see section [Configuring the ABB AC500-S Safety PLC](#) on page 233 or section [Configuring the Siemens SIMATIC Fail-safe S7 PLC](#) on page 251).
3. Update the revision and the serial number of the new FB module to the logbook of the driven machine.

■ Replacing the FSE module

1. Disconnect the encoder connector and power supply connector, then remove the FSE module.
2. Replace the FSE module according to the instructions in *FSE-31 pulse encoder interface module user's manual* (3AXD50000016597 [English]).
3. Update the revision and the serial number of the new FSE module to the logbook of the driven machine.

■ Replacing the safety encoder

1. If the new encoder is not identical with the old encoder: Make sure that the encoder meets the requirements in section [Safety encoders](#) on page 43.
2. Install the new encoder according to the installation instructions given by the encoder manufacturer and the instructions given in the FSO-21 module and FSE-31 module user's manuals.
3. Make sure that the safety encoder related parameter settings in FSO-21 module, for example, pulse count, are set according to the new encoder.
4. Do the start-up and validation procedures. See section [Start-up and validation test](#) on page 512.

■ Start-up and validation test

1. Do the start-up procedure according to chapter [Start-up](#).
 2. Do the validation procedure for each safety function according to chapter [Verification and validation](#).
-

Factory reset

Do a factory reset if

- you forget the password
- you want to do the configuration again from scratch.

Note: The factory reset clears the configuration and takes the factory default values back in use. These factory default values are not the same as the pre-set values in a delivered FSO (ordered with a plus code). The factory default values are invalid for restart. The FSO needs a full reconfiguration before it can be restarted. You can also use the safety file that was saved at the first start-up (see page 312).

1. Make sure that the motor is stopped.
2. Lift the Factory reset label on the right side of the I/O terminals. Push the button underneath with, for example, a pen until the LEDs start to flash (approximately 5 seconds). This returns the factory settings (parameters, including the password) to the FSO.

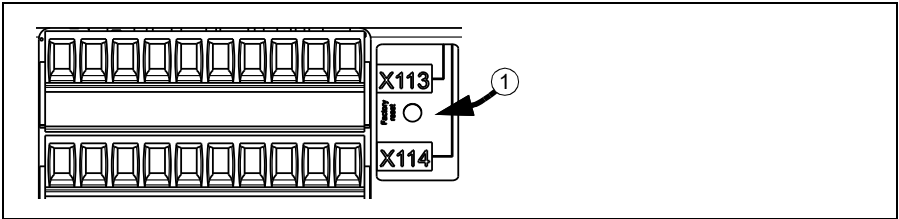

3. Reconfigure the safety functions with the Drive Composer pro PC tool. To be able to restart the drive, make sure that at least these parameters are set to suitable values according to your application:

| Parameter index | Name | Factory default value | Pre-set value (with option +Q972) |
|------------------|--|-----------------------|-----------------------------------|
| <i>FSOGEN.21</i> | Motor nominal speed | 100.0 rpm | 1500.0 rpm |
| <i>FSOGEN.22</i> | Motor nominal frequency | 1 Hz | 50 Hz |
| <i>FSOGEN.41</i> | Power-up acknowledgement | Manual | Automatic |
| <i>STO.02</i> | STO acknowledgement | Manual | Automatic |
| <i>STO.13</i> | Restart delay after STO | 3,600,000 ms | 2000 ms |
| <i>STO.14</i> | Time to zero speed with STO and modoff | 3,600,000 ms | 2000 ms |
| <i>SBC.11</i> | STO SBC usage | Delayed brake | None |
| <i>SLSx.02</i> | SLS acknowledgement | Manual | Automatic |

4. Set a new password with the tool.

Drive control board boot

If you reboot the drive control board (for example, by cycling the power or with parameter *96.08 Control board boot* (in DCS880 drives: *96.27 Control board boot*)), the FSO module goes into the Fail-safe mode.

To exit the Fail-safe mode:

- switch the FSO module power off and then switch it back on, or
- reboot the FSO module with drive parameter *96.09 FSO reboot* (in DCS880 drives: *96.28 FSO reboot*), or
- click the **Reboot FSO** button in Drive Composer pro.

Note: The STO function must be completed before you can reboot the FSO module with parameter *96.09 FSO reboot* (in DCS880 drives: *96.28 FSO reboot*) or with the **Reboot FSO** button. See section [Safe torque off \(STO\)](#) on page 68.

Updates

After any changes in the safety application or the safety system configuration, you must perform the acceptance tests to verify that the safety functionality is maintained. See chapter [Verification and validation](#).

Proof tests

Periodic proof testing of the safety system may be required in order to maintain the claimed SIL / PL level of the system, to ensure that the safety integrity of a safety system is maintained continuously and does not deteriorate over time.

If proof testing is required, it must be taken into consideration in the safety calculations, maintenance manuals, user documentation, and it must be done periodically.

In high demand mode of operation, the maximum proof test interval for the FSO module is 20 years. In low demand mode of operation, the maximum proof test interval for FSO is 20, 5 or 2 years. You must select the proof test interval according to the application where the modules are used. See section [Safety data](#) on page 522.

Proof testing of the FSO module can be done by following the instructions in section [Validation of safety functions](#) on page 466. A reboot of the FSO module is necessary for the proof test.

Decommissioning



WARNING! Obey the instructions in chapter [Safety instructions](#). If you ignore them, injury or death, or damage to the equipment can occur.

When you decommission the FSO or FSE module, make sure that the safety of the machine is maintained until the decommissioning is complete. Mark clearly on the module that it is decommissioned.

If you use the SMS function, version 2, obey the instructions in section [SMS function, version 2](#) on page [180](#).



Technical data

Contents of this chapter

This chapter contains the technical specifications of the FSO-21 module.

Electrical data

| | |
|----------------------------|--|
| Supply voltage | +24 ± 3 V DC (SELV/PELV) |
| Current consumption | Maximum 1000 mA (external power supply) |
| Inputs | 4 redundant or 8 single, or combinations of redundant and single, 24 V DC NPN
Maximum time delay between redundant input channels: 300 ms
Maximum test pulse tolerance: 2 ms |
| Outputs | 3 redundant or 6 single, or combinations of redundant and single, 24 V DC PNP |
| EMC | Complies with EMC standards EN 61800-3:2004 and IEC 61000-6-7:2014. Max. STO cable length: see STO cable and data cable between FSO module and drive on page 519. |

PROFIsafe and related network devices

All network devices used in conjunction with this device shall meet the requirements of IEC 61010-1 or IEC 61131-2.

Control connection data

| | |
|--|---|
| Logic levels | "0" < 5 V, "1" > 15 V |
| Digital input impedance | 4 kohm |
| Digital output capability | 150 mA @ 20 V each, 700 mA @ 20 V total when all outputs are in use |
| Max. cable length between digital input/output and external device | 250 m (820 ft) |
| Max. current through signal ground terminals (X113:5, X113:6, X114:5, X114:6) | 1000 mA |

Terminal and cable entry data for the control cables

| Conductor size | | | | | | Tightening torque | |
|-------------------|---------|--|---------|---------------------------------------|---------|-------------------|--------|
| Solid or stranded | | Stranded, ferrule without plastic sleeve | | Stranded, ferrule with plastic sleeve | | | |
| Min/Max | Min/Max | Min/Max | Min/Max | Min/Max | Min/Max | N·m | lbf·in |
| mm ² | AWG | mm ² | AWG | mm ² | AWG | | |
| 0.14/1.5 | 26/16 | 0.25/1.5 | 23/16 | 0.25/0.5 | 23/21 | 0.24 | 2.1 |

| Conductor size, two conductors with the same cross section | | | | | | | | Tightening torque | |
|--|---------|-----------------|---------|---|---------|---|---------|-------------------|--------|
| Solid | | Stranded | | Stranded, ferrules without plastic sleeve | | Stranded, TWIN ferrules with plastic sleeve | | | |
| Min/Max | Min/Max | Min/Max | Min/Max | Min/Max | Min/Max | Min/Max | Min/Max | N·m | lbf·in |
| mm ² | AWG | mm ² | AWG | mm ² | AWG | mm ² | AWG | | |
| 0.08/0.5 | 28/21 | 0.08/0.75 | 28/19 | 0.25/0.34 | 23/22 | 0.5/0.5 | 21/21 | 0.24 | 2.1 |

STO cable and data cable between FSO module and drive

| | |
|-------------------|--|
| STO cable | <p>ABB recommends to use the cable included in the delivery.
User-defined cable:</p> <ul style="list-style-type: none"> • Maximum length: 1 m (3.28 ft) • Use the connectors of the original STO cable. Tightening torque is 0.24 N·m (2.1 lbf-in). • See pin order in section Terminals on page 301. • Installation must comply with good installation practices (routing, shielding, supporting, strain relief). |
| Data cable | Use only the data cable included in the delivery. |

Tightening torques

| Image | No. | Description | Torque |
|-------|-----|--|-----------------------|
| | 1. | Grounding screw, FSO module electronics | 1.2 N·m (10.6 lbf-in) |
| | - | Screws that attach mounting plate to FSO module, 4 pcs. On the back. | 0.96 N·m (8.5 lbf-in) |
| | 3. | Screws that ground the mounting plate to drive (metal to metal). | 1.2 N·m (10.6 lbf-in) |
| | OR | Screws that attach the mounting plate to drive (metal to plastic). | 0.79 N·m (7.0 lbf-in) |

Size and weight

| | mm | in | kg | lb |
|----------------------------|-----|------|-------|-------|
| Length | 100 | 3.94 | - | - |
| Width | 60 | 2.36 | - | - |
| Depth (with wiring) | 50 | 1.97 | - | - |
| Weight | - | - | 0.230 | 0.507 |

Cooling

| | |
|-----------------------|------------------------------------|
| Cooling method | Dry clean air (natural convection) |
|-----------------------|------------------------------------|

Compatible motor types

| | |
|---------------------------|---|
| Motor type | Induction motor (IM), Permanent magnet motor (PM), Synchronous reluctance motor (SynRM), DC motor |
| Motor control mode | FSO can be used in Direct Torque Control (DTC) or scalar mode. |

Speed estimation

| | |
|------------------------------|--|
| Speed range | Allowed range depends on the used motor.
Maximum range: $(-35880...+35880 \text{ rpm})/(\text{number of motor pole pairs})$. |
| Accuracy | The speed estimation error is \pm motor slip.
There can also be estimation ripples at the zero speed region (below 2 Hz / 3% of the nominal speed). For more information, see section Safe speed estimate on page 44. |
| Operational frequency | Drive output up to 598 Hz |

Ambient conditions

| | Operation
installed for
stationary use | Storage
in the protective
package | Transportation
in the protective
package |
|------------------------|--|--|---|
| Altitude | 0...1000 m
(0...3300 ft) above
sea level, no derating
required

1000...2000 m
(3300...6600 ft)
above sea level, air
outside the module
derated to
-15...+49 °C
(+5...+120 °F)

2000...4000 m
(6600...13200 ft)
above sea level, air
outside the module
derated to
-15...+40 °C
(+5...+104 °F) | - | - |
| Air temperature | -15...+70 °C
(+5...+158 °F) | -40...+70 °C
(-40...+158 °F) | -40...+70 °C
(-40...+158 °F) |

| | Operation
installed for
stationary use | Storage
in the protective
package | Transportation
in the protective
package |
|---|--|--|---|
| Relative humidity | 5...95%, no condensation allowed. If corrosive gases are present, the maximum allowed humidity is 60%. | | |
| Contamination levels
IEC 60721-3-x | No contaminants, conductive dust or corrosive dust allowed.
Use at least IP54 enclosure in an environment where conductive dust or corrosive dust exists. | | |
| Chemical gases | Class 3C2 | Class 1C2 | Class 2C2 |
| Solid particles | Class 3S2. No
conductive dust
allowed. | Class 1S3 | Class 2S2 |
| Vibration
IEC 60068-2-6,
Test Fc (2007-12) | Frequency range:
2...9 Hz: Constant deflection = 7 mm
9...200 Hz: Constant acceleration = 20 m/s ² | | |
| Shock IEC 60068-2-27
Test Ea (2008-02) | Peak acceleration 50 m/s ² . Pulse duration 30 ms, 3 pulses in each direction with STO and SS1 functions activated. | | |
| Atmospheric pressure | 70 ... 106 kPa (0.7 ... 1.05 atmospheres) | | |

For the environmental limits for the drive, refer to the hardware manual of your drive.

Safety functions

| Stopping functions | |
|--------------------------------|--|
| STO | Safe torque off |
| SBC | Safe brake control |
| SS1 | Safe stop 1 |
| SSE | Safe stop emergency |
| Speed-related functions | |
| SLS | Safely-limited speed |
| Variable SLS | Variable Safely-limited speed |
| SMS | Safe maximum speed |
| SSM | Safe speed monitor |
| SDI | Safe direction |
| SAR | Safe acceleration range - SAR is used only for deceleration with SS1, SSE, SDI and SLS and Variable SLS functions. |
| Other | |
| POUS | Prevention of unexpected start-up |

Safety data

General

To determine the SIL/PL capability of the whole safety function where the FSO is included, the failure rates (PFD_{avg}/PFH) of all components implementing the safety function (see the figure below) must be added.

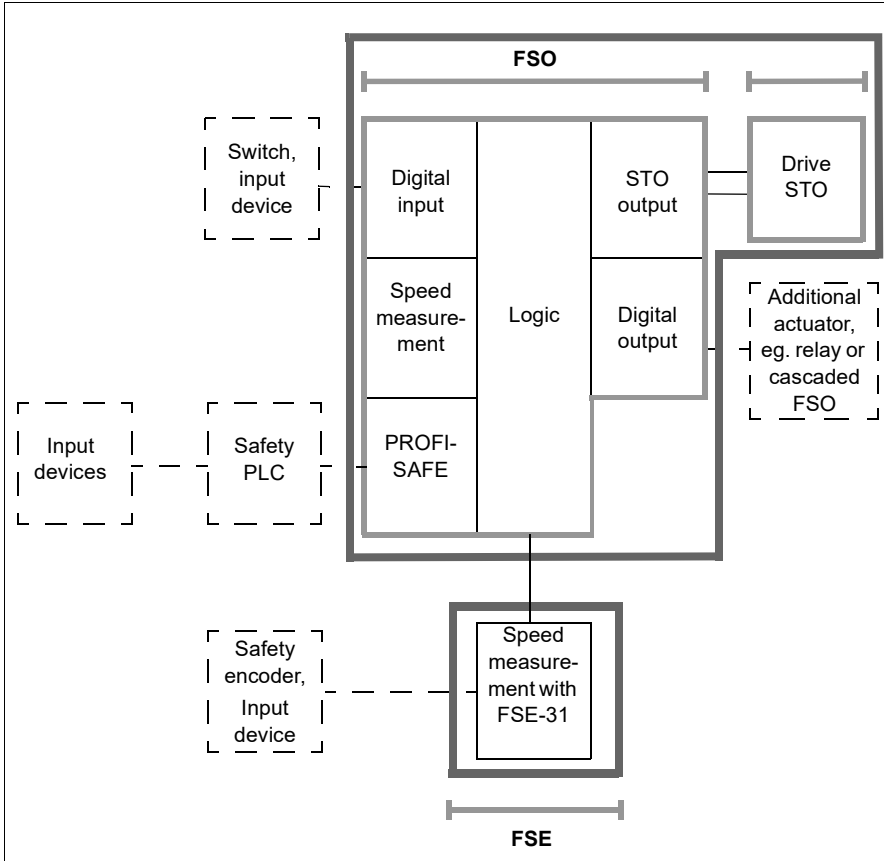

- **FSO module with its subsystems.** The FSO acts as the logic part in the safety function. The safety data for the safety function where FSO and drive are used is composed of the safety data of the subsystems. Safety data for different subsystems is shown in section [Basic safety data](#) on page 524.
- **Digital inputs and outputs.** Subsystems for the digital inputs and outputs of the FSO. Can be used as single or dual channel and with or without diagnostic pulses.

- **Speed measurement subsystem** is a mix of two different safety data as the speed estimation is calculated independently by the FSO and the drive. In the safety data tables, these two safety data are already combined in the safety data of this subsystem. This subsystem can be used together with the following safety functions: STO (with or without SBC), SS1, SSE, SLS, varSLS, SMS, and SSM.
Note: POUS does not use any speed measurement subsystem.
- **PROFIsafe** is a subsystem for the reliability of PROFIsafe connection. This subsystem is used in case the PROFIsafe connection is in use in the application through FENA-21 or FPNO-21 module. FSO module takes care of the reliability and safety of this connection.
- **Logic subsystem** is included in each safety function implemented with the FSO.
- **STO output from the FSO** to the Drive STO. STO is a critical subsystem for all safety functions other than SSM. Therefore it shall be included in safety calculations of those functions.
- **Drive STO** is the actuator for the STO of the drive. For the safety data, see the drive hardware manual.
Note: All safety functions (except SSM) have the capability to activate STO. This means that STO subsystems (STO output and Drive STO) are always part of the safety function's calculations even though it might not be activated in normal use.
- **Speed measurement with FSE-31** is a subsystem for safety encoder interface, FSE-31. This subsystem can be used with following safety functions: STO (with or without SBC), SS1, SSE, SLS, varSLS, SMS, SSM, and SDI. SDI and STO with speed limit activated SBC always use speed measurement with encoder.
- **Sensors, input devices, encoders, PLCs, and possible additional actuators.** See section [FSO safety calculations guide \(without PROFIsafe\)](#) on page 526. For the safety data, see the manufacturer's documentation.

After calculating the total PFDavg/PFH for the safety function, it must be verified that the PFDavg/PFH of the safety function fulfills the requirement for the targeted SIL/PL.

For additional information on safety calculations, see standards EN ISO 13849-1, EN/IEC 62061, IEC 61508, IEC 61511, or *ABB Drives Technical guide No. 10, Functional safety* (3AUA0000048753 [English]).

Basic safety data

The FSO-21 module is a type B safety component as defined in IEC 61508-2.

The FSO-21 data related to safety standards IEC 61508, EN/IEC 61800-5-2, EN ISO 13849-1, IEC 61511, and EN/IEC 62061 is listed below for the different subsystems within the FSO module.

The maximum useful mission time (T_m) for the FSO module is 20 years. After 20 years, the module must be replaced.

The given safety data is applicable with these proof test intervals:

- T1 = 20 years (high demand and continuous mode of operation)
- T1 = 2, 5, or 20 years (low demand mode of operation).

Make sure that the proof test is performed within this time (see also section [Proof tests](#) on page 514).

| EN/IEC 61508 | | EN ISO 13849-1 | | EN/IEC 62061 | |
|--------------|---------|----------------|---------|--------------|---|
| SIL | up to 3 | PL | up to e | SIL | 3 |

3AXD10001287182 C

| | 1-ch. DI, pulses | 2-ch. DI, pulses | 1-ch. DI, no pulses | 2-ch. DI, no pulses | Logic | PROFI-safe ¹⁾ |
|-----------------------------------|------------------|------------------|---------------------|---------------------|---------|--------------------------|
| SIL | 3 | 3 | 2 | 3 | 3 | 3 |
| PL | d | e | c | e | e | e |
| PFH (1/h)
(T1 = 20 a) | 1.1E-10 | 5.5E-12 | 1.1E-08 | 2.9E-11 | 1.1E-11 | 1.0E-09 |
| PFD _{avg}
(T1 = 2 a) | 5.8E-08 | 5.9E-08 | 5.7E-06 | 6.7E-07 | 9.9E-08 | 8.8E-06 |
| PFD _{avg}
(T1 = 5 a) | 1.4E-07 | 1.5E-07 | 1.4E-05 | 1.7E-06 | 2.5E-07 | 2.2E-05 |
| PFD _{avg}
(T1 = 20 a) | 5.8E-07 | 5.9E-07 | 5.8E-05 | 6.7E-06 | 9.9E-07 | 8.8E-05 |
| MTTF _D (a) | 10747 | 10431 | 10628 | 10738 | 11290 | 114155 |
| HFT | 0 | 1 | 0 | 1 | 1 | - |
| Cat. | 2 | 3 | 1 | 3 | 3 | 4 |
| SFF (%) | 99.7 | 99.7 | 73.5 | 98.6 | 99.0 | 99.0 |
| DC (%) | 99.0 | 99.0 | 1.4 | 94.6 | 96.7 | 99.0 |

3AXD10001287182 C

1) We assume conservatively that PFH = $\lambda d = 1$, FIT = $1e-9$ 1/h, $MTTF_D = 1/\lambda d = 1/(1e-9$ 1/h) = $1e9$ h = 114155 a. Based on the BGIA Report 2/2008e: Functional Safety of Machine Controls – Application of EN ISO 13849, ch. 6.2.17.

| | 1-ch. DO, pulses | 2-ch. DO, pulses | 1-ch. DO, no pulses | 2-ch. DO, no pulses | STO output | Speed estimate, worst case values | Speed measurement with FSE-31 |
|---|------------------|------------------|---------------------|---------------------|------------|-----------------------------------|-------------------------------|
| SIL | 3 | 3 | 1 | 3 | 3 | 3 | 3 |
| PL | d | e | c | e | e | e | e |
| PFH (1/h)
(T1 = 20 a) | 6.3E-10 | 1.7E-10 | 4.9E-09 | 2.2E-10 | 1.8E-11 | 1.0E-08 | 6.4E-08 |
| PFD_{avg}
(T1 = 2 a) | 3.8E-07 | 1.5E-06 | 2.3E-06 | 2.4E-06 | 1.6E-07 | 1.4E-04 | 9.7E-05 |
| PFD_{avg}
(T1 = 5 a) | 9.6E-07 | 3.7E-06 | 5.7E-06 | 5.9E-06 | 3.9E-07 | 2.7E-04 | 9.9E-04 |
| PFD_{avg}
(T1 = 20 a) | 3.8E-06 | 1.5E-05 | 2.3E-05 | 2.4E-05 | 1.6E-06 | 5.0E-04 | - |
| MTTF_D (a) | 2412 | 2406 | 2412 | 2412 | 321699 | 164 | 3360 |
| HFT | 0 | 1 | 0 | 1 | 1 | 0 | 1 |
| Cat. | 2 | 3 | 1 | 3 | 3 | 3 | 3 |
| SFF (%) | 99.5 | 97.5 | 96.2 | 96.6 | 99.4 | 99.0 | 96.8 |
| DC (%) | 98.7 | 92.9 | 89.6 | 90.7 | 99.0 | 99.0 | 96.6 |

3AXD10001287182 C

■ FSE-31 pulse encoder interface module

The FSE-31 module is a type B safety component as defined in IEC 61508-2.

The FSE-31 data related to safety standards IEC 61508, EN/IEC 61800-5-2, EN ISO 13849-1 and EN/IEC 62061 is listed below.

The maximum useful mission time (T_m) for the FSE module is 20 years. After 20 years, the module must be replaced.

The given safety data is applicable with proof test interval $T1 = 20$ years (high demand and continuous mode of operation), or $T1 = 2$ or 5 years (low demand mode of operation). Make sure that the proof test is performed within this time (see also section [Proof test intervals during operation](#) on page 489).

| SIL | PL | SFF (%) | PFH (T1 = 20 a) (1/h) | PFD _{avg} (T1 = 2 a) | PFD _{avg} (T1 = 5 a) | MTTF _D (a) | DC (%) | SC | Cat. | HFT | CCF |
|-----|----|---------|-----------------------|-------------------------------|-------------------------------|-----------------------|--------|----|------|-----|-----|
| 3 | e | 99.06 | 1.87E-08 | 8.54E-06 | 8.68E-05 | 16695 | 99 | 3 | 3 | 1 | 80 |

3AXD10000289254 M

■ FSO safety calculations guide (without PROFIsafe)

STO, SS1-t, SSE-t and SSE with immediate STO

Block diagram for single channel solution:

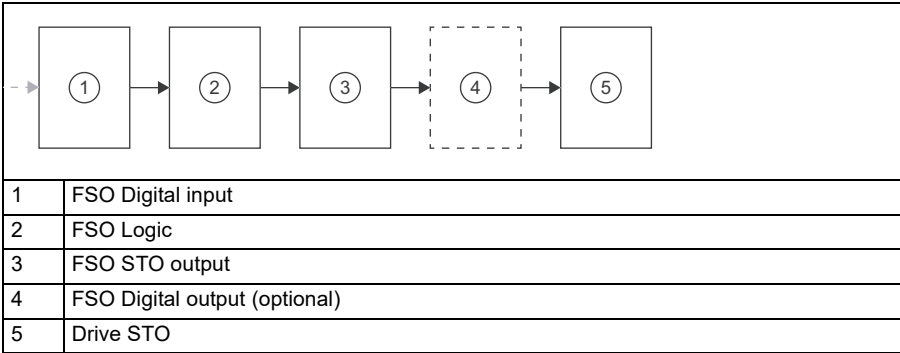

Block diagram for dual channel solution:

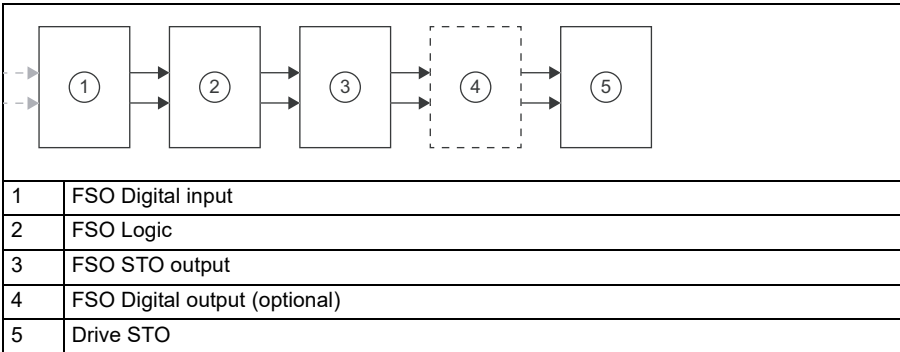

STO and other stopping functions with FSO include FSO subsystems Digital input, Logic, possible Digital output and STO output, and Drive STO. In the figure above, safety function is implemented with 1-channel and non-pulsed signals. Figure 2 shows a 2-channel solution. Signals may be either pulsed or non-pulsed. However, all choices have an effect on safety values. Block diagrams are equal to SS1-t, SSE-t and SSE with immediate STO functions. Same approach for the logic subsystems applies in all safety functions below.

Note: ABB's safety data component libraries do not contain any subsystems for external (non-ABB) components.

Note: All safety functions in FSO can be activated either through safety IOs or through PROFIsafe. In case PROFIsafe is used, safety IOs are optional.

Encoderless SLS or SS1-r

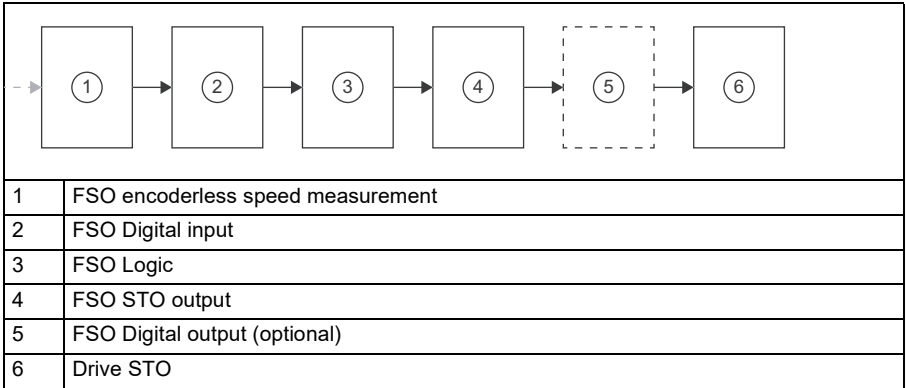

Safely-limited speed (SLS) without encoder includes the following subsystems: FSO encoderless speed measurement, FSO Digital input, FSO Logic, FSO STO output, FSO digital output (optional), and Drive STO. Block diagram is equal to SS1-r function.

SLS with encoder, SDI and SS1-r

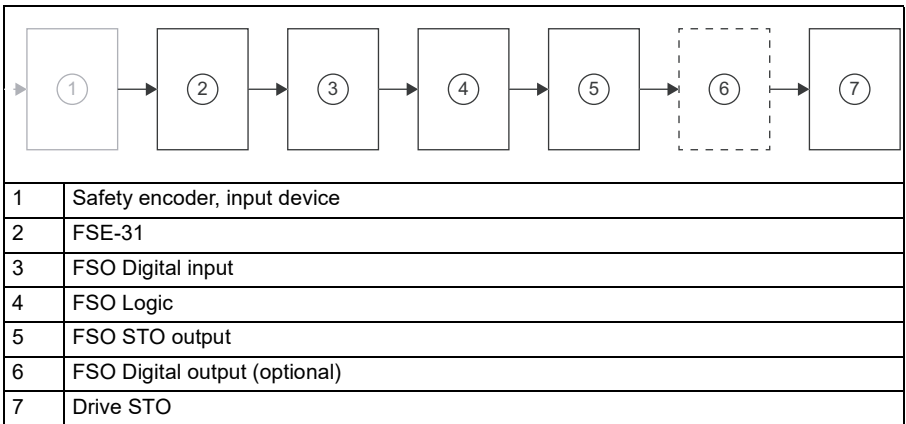

Safely-limited speed (SLS) with encoder includes the following subsystems: safety encoder (not provided by ABB), FSE-31, FSO Digital input, FSO Logic, FSO STO output, FSO Digital output (optional), and Drive STO. Block diagram is equal to SDI and SS1-r.

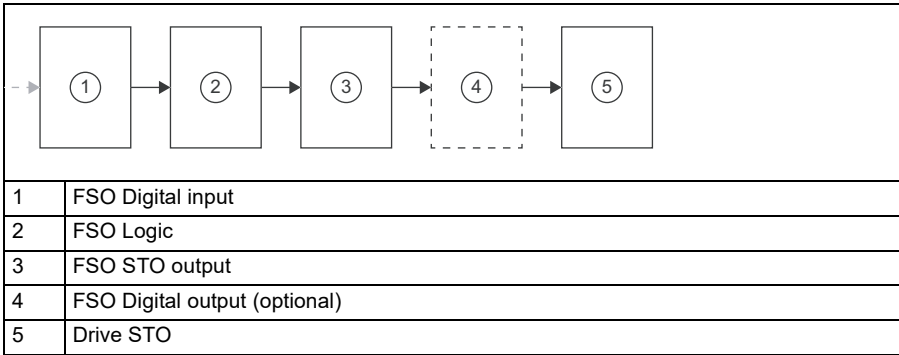
POUS

Prevention of unexpected start-up (POUS) includes the following subsystems: FSO Digital input, FSO Logic, FSO STO output, FSO Digital output (optional), and Drive STO.

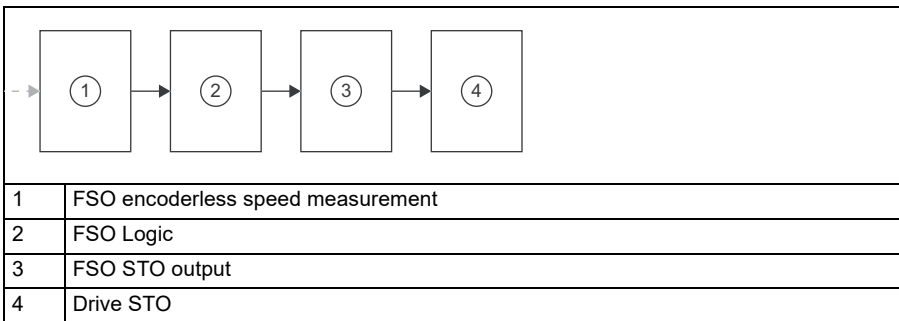
SMS without encoder

Safe maximum speed (SMS) includes the following subsystems: FSO encoderless speed measurement, FSO Logic, FSO STO output, and Drive STO.

SMS with encoder

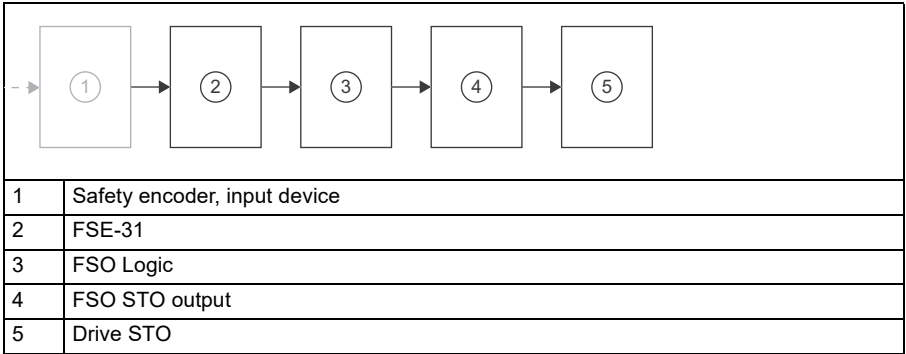

Safe maximum speed (SMS) includes the following subsystems: safety encoder (not provided by ABB), FSE-31, FSO Logic, FSO STO output, and Drive STO.

SBC

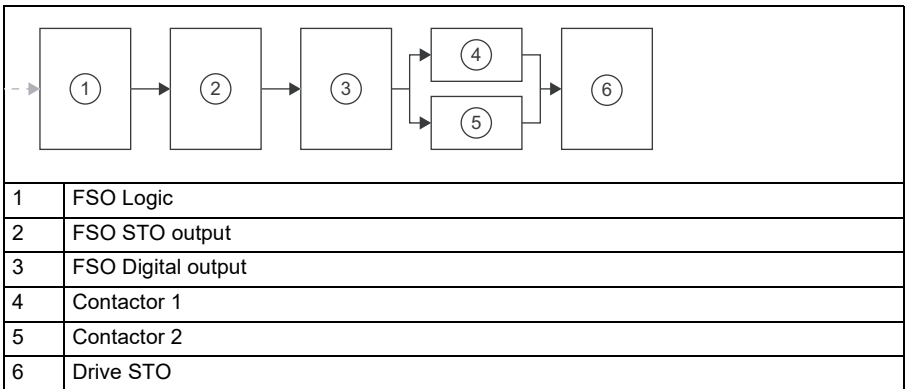

Safe brake control (SBC) includes the following subsystems: FSO Logic, FSO STO output, FSO Digital output, Contactor 1 and 2 (can be provided by ABB), and Drive STO.

Note: SBC is used together with other safety functions, and a triggering subsystem must be included in the calculation.

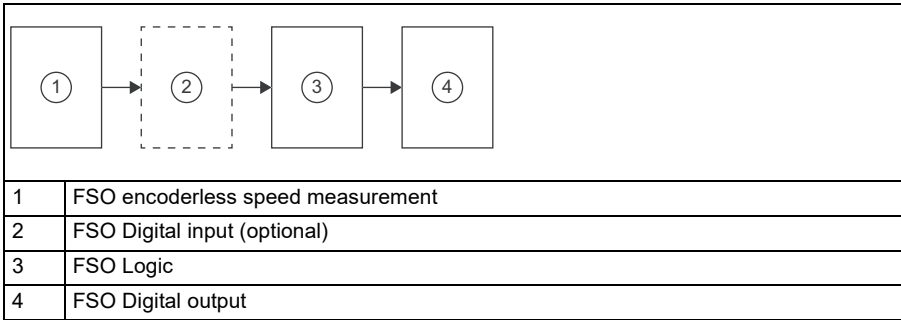
SSM without encoder

Encoderless SSM includes the following subsystems: FSO encoderless speed measurement, FSO Digital input (optional), FSO Logic, and FSO Digital output.

Note: This safety function, SSM without encoder, can be configured so that it is permanently on. In this case digital input is not included in the safety calculation.

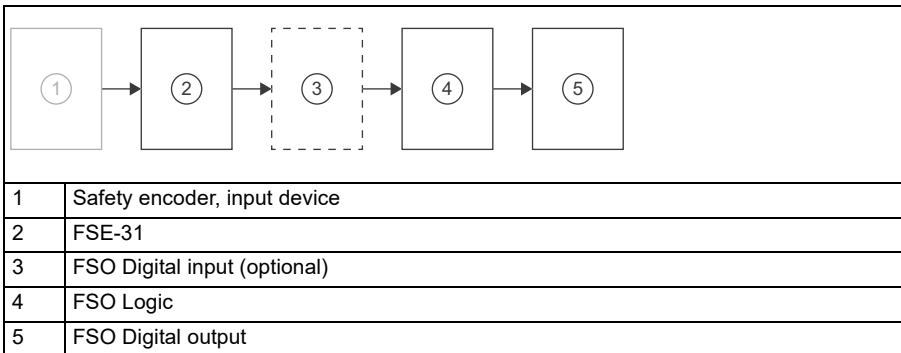
SSM with encoder

Safe speed monitor (SSM) with encoder includes the following subsystems: safety encoder (not provided by ABB), FSE-31, FSO Digital input (optional), FSO Logic, and FSO Digital output.

Note: This safety function, SSM with encoder, can be configured so that it is always active. In this case digital input is not included in the safety calculation.

FSO safety calculations guide (with PROFIsafe)

Safety functions can also be implemented with PROFIsafe over PROFINET connectivity. FSO has own subsystem for PROFIsafe communication which is used together with other FSO internal subsystems.

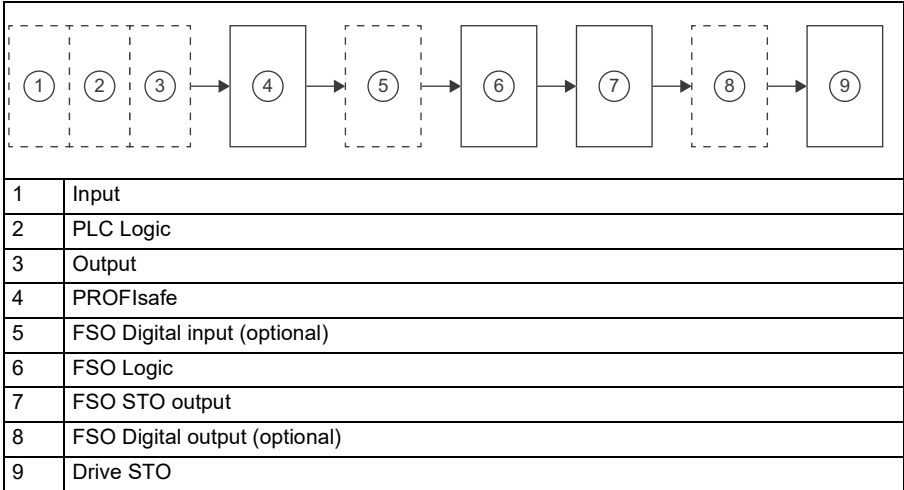

PROFIsafe can replace digital inputs and/or digital outputs of the FSO. For example, it is possible to use PROFIsafe input and FSO output in the same configuration.

It is also possible to read and activate FSO I/O's through the PROFIsafe connection. In this case, the safety block diagram must contain either the FSO input or the FSO output subsystem.

It is also possible that customer's PLC uses safe position information to operate a safety function. In this case, FSE-31 subsystem should be added in the calculation.

Relevant failure modes

The following failure modes related to the outputs of the FSO-21 with or without FSE-31 have been considered in the design:

- STO output
- PROFIsafe
- Digital outputs.

The relevant dangerous failure mode due to internal random hardware failure of FSO-21 with/without FSE-31 are that these outputs are not activated on command.

The probabilities of the dangerous undetected failures of the safety functions are given in the basic safety table.

FSO-21 and FSE-31 implement several diagnostics to detect internal random hardware failures. The diagnostics cycle time for each of the channels is 10 hours or less. The diagnostics of each channel is separate and independent of the other channel.

The relevant failure mode of the diagnostics is that, due to a random hardware fault in the diagnostic system, the fault reaction is not performed while a detectable fault in the safety function is present.

Response times

| | |
|---|--|
| <p>Safety function response time</p> | <p>ACS880 drives: Maximum response time of the FB module (FPNO or FENA), FSO, FSE and drive combination is 100 ms.
DCS880 drives: Maximum response time is 550 ms.
Note: Mute time usage increases the response time.</p> |
| <p>FSO-21 response time</p> <ul style="list-style-type: none"> from an FSO input to an FSO digital output activation | <p>Maximum 35 ms</p> |
| <p>Cascade response time</p> <ul style="list-style-type: none"> from FSO's STO activation to the cascade output activation from the cascade input to the cascade output activation | <p>Maximum 35 ms
Maximum 35 ms

If the STO is cascaded, safety function response time for the cascaded units is $(n-1) \times 35 \text{ ms} + 100 \text{ ms}$, where n is the number of cascaded FSO modules.</p> |
| <p>PROFIsafe</p> <ul style="list-style-type: none"> Worst-case delay time (WCDT) Device acknowledgement time (DAT) | <p>54 ms (FSO and FB module combination)
54 ms</p> |

Example 1 - Response times

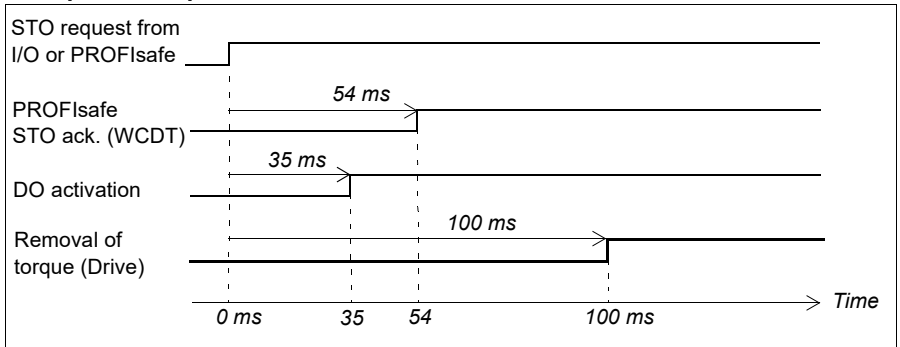

Note: The values shown above are applicable to ACS880 drives. The maximum response time for DCS880 drives is 550 ms.

Example 2 - Response times for cascading

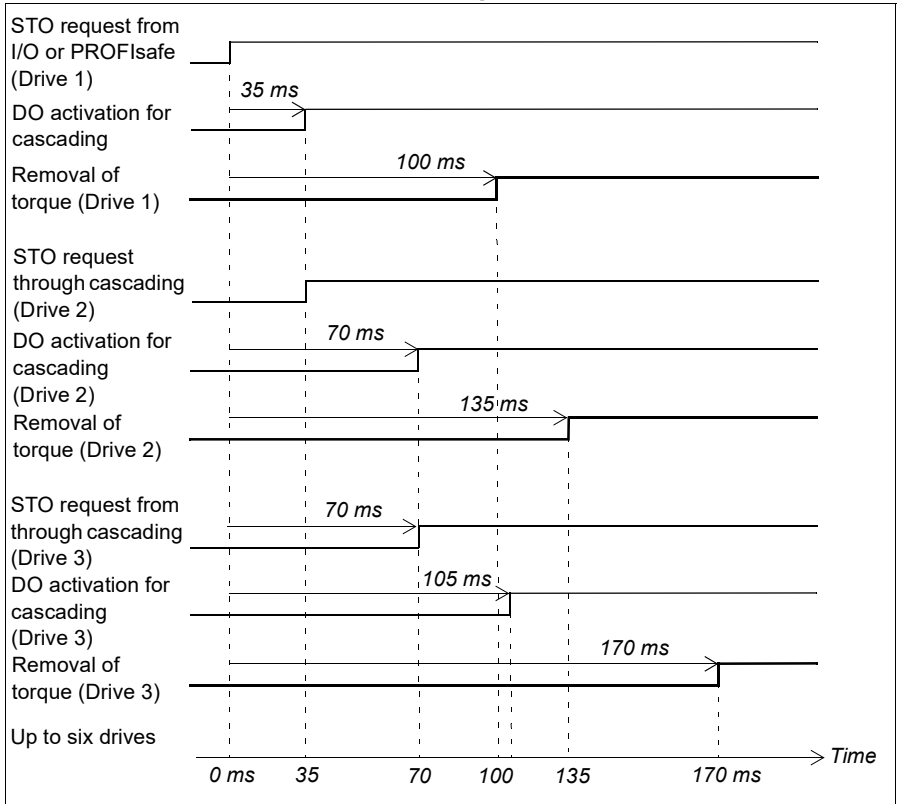

Note: The values shown above are applicable to ACS880 drives. The maximum response time for DCS880 drives is 550 ms.

Ordering information

Ordering codes for related kits:

| | |
|------------|-----------------|
| FSO-21 kit | 3AXD50000023987 |
| FSE-31 kit | 3AXD50000023272 |
| FENA-21 | 3AUA0000089109 |
| FPNO-21 | 3AXD50000192779 |

Option codes (plus codes) when ordered together with drive:

| | |
|------------|-------|
| FSO-21 | +Q972 |
| FSE-31 kit | +L521 |
| FENA-21 | +K475 |
| FPNO-21 | +K492 |

Related standards and directives

Referenced standards are listed in the table below.

| Standard | Name |
|---|---|
| EN 60204-1:2018
IEC 60204-1:2016 | <i>Safety of machinery – Electrical equipment of machines – Part 1: General requirements</i> |
| IEC 61508 Parts 1-3,
Ed. 2.0:2010 | <i>Functional safety of electrical/electronic/programmable electronic safety-related systems</i> |
| IEC 61800-5-2:2016
EN 61800-5-2:2007 | <i>Adjustable speed electrical power drive systems – Part 5-2: Safety requirements – Functional</i> |
| IEC 62061:2021
EN 62061:2005
+AC:2010+A1:2013+
A2:2015 | <i>Safety of machinery – Functional safety of safety-related electrical, electronic and programmable electronic control systems</i> |
| EN ISO 12100:2010 | <i>Safety of machinery – General principles for design – Risk assessment and risk reduction</i> |
| EN ISO 13849-1:2015 | <i>Safety of machinery – Safety-related parts of control systems – Part 1: General principles for design.</i> |
| EN ISO 13849-2:2012 | <i>Safety of machinery – Safety-related parts of control systems – Part 2: Validation</i> |
| IEC 61800-3:2004
+A1:2011 | <i>Adjustable Speed Electrical Power Drive Systems - Part 3: EMC requirements and specific test methods</i> |
| IEC 61000-6-7:2014 | <i>Electromagnetic compatibility (EMC) - Part 6-7: Generic standards - Immunity requirements for equipment intended to perform functions in a safety-related system (functional safety) in industrial locations</i> |
| IEC 60533:2015 | <i>Electrical and electronic installations in ships - Electromagnetic compatibility (EMC) - Ships with a metallic hull</i> |
| EN ISO 13850:2015 | <i>Safety of machinery - Emergency stop function - Principles for design</i> |
| ISO 14118:2017 | <i>Safety of machinery - Prevention of unexpected start-up</i> |
| 2006/42/EC | <i>European Machinery Directive</i> |
| | <i>PROFIsafe System Description – Safety Technology and Application. Version November 2010. Order Number 4.342.</i> |
| | <i>PROFIsafe - Profile for Safety Technology on PROFIBUS DP and PROFINET IO, V2.4</i> |
| Other | Sector-specific C-type standards |



Dimension drawings

The dimension drawings of the FSO-21 module with two different bottom plates for different drive control unit types are shown below. The dimensions are given in millimeters and [inches].

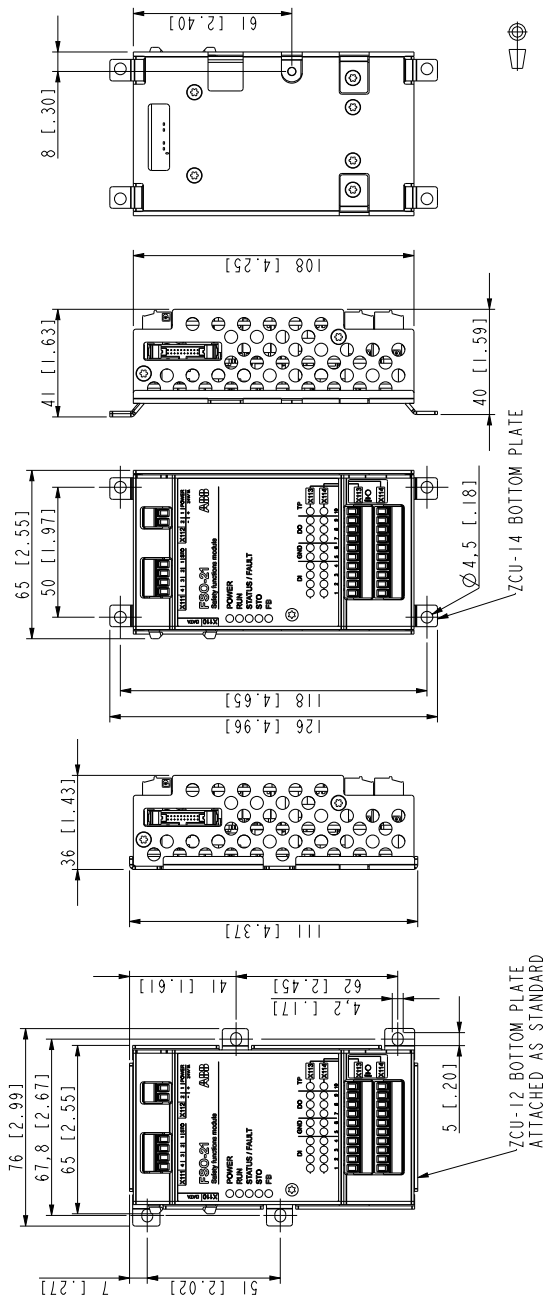

3AXD50000018513

Further information

Product and service inquiries

Address any inquiries about the product to your local ABB representative, quoting the type designation and serial number of the unit in question. A listing of ABB sales, support and service contacts can be found by navigating to abb.com/searchchannels.

Product training

For information on ABB product training, navigate to new.abb.com/service/training.

Providing feedback on ABB Drives manuals

Your comments on our manuals are welcome. Navigate to new.abb.com/drives/manuals-feedback-form.

Document library on the Internet

You can find manuals and other product documents in PDF format on the Internet at abb.com/drives/documents.



abb.com



3AXD50000015614J