PRODUCT BROCHURE

E-Klips[®] rail heater fixings and cable management systems

E-Klips[®]



E-Klips® is a UK-based spring steel fastener brand, delivering robust, flexible and easy to install fixing solutions for a wide range of applications. It offers a quick, easy and reliable method of fixing services to steelwork without the need for bracket making, drilling holes or the use of nuts and bolts.

E-Klips® rail heater fixings and cable management systems

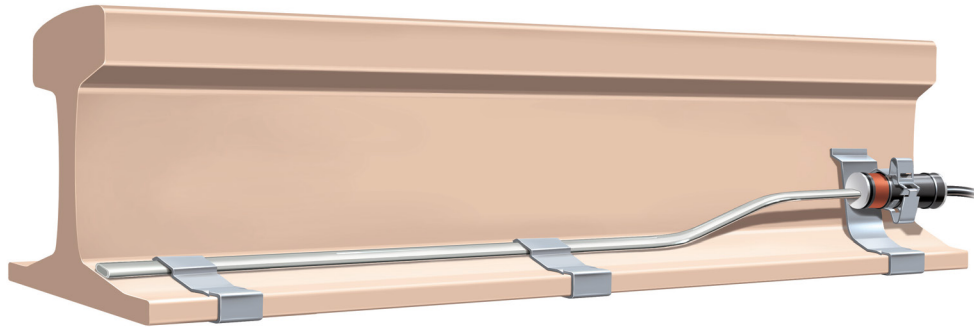

The E-Klips® range of rail heater fixings has been designed based on the latest market demands and installation requirements. Strong, easy to install and lightweight, the range includes clips for a variety of rail profiles.

Materials

The fixings are manufactured from carbon spring steel, which has excellent shape retention properties. The material can cope with the extreme temperatures under which the clips operate, and allows the heater strip to efficiently transfer heat to the rail section.

Heat treatment

After being formed, the fixings are heat treated to create a clip with good spring qualities, a strong grip and the ability to take the force applied during installation without damage.

Surface finish

The zinc based, chromium-free coating used on the fixings has the ability to withstand a 600 hour salt spray test. It is environmentally friendly and meets the requirements for a low solvent content material.

Strength

The fixings have been designed for maximum strength. On flat-bottomed rails, the multiple points of contact exert a balanced force and their wedge shape prevents the clips from moving, even under extreme conditions. Tests have shown that the fixings can withstand a pull-off force in excess of similar products. The unique one-piece bull head clips wrap around the rail profile to give unrivalled strength.

E-Klips® rail heater fixings - Product selector

Rail type (mm)	Foot mount	Tie wrap	Barrel clamp	Head mount	Web mount	Cable clip	Temp. sensor
UIC 60 (11 x 150 x 172)	FRC-60-F 055/009155	FRC-60-C 055/009194	FRC-60-B 055/009158	-	FRC-60-LU -	FRC-54-LU -	FRC-60-S 055/009175
UIC 54 (11 x 140 x 159)	FRC-60-F 055/009155	FRC-60-C 055/009194	FRC-60-B 055/009158	FRC-54-H 055/009161	FRC-60-LU -	FRC-54-LU -	FRC-60-S 055/009175
BS 110 (11 x 139 x 158)	FRC-60-F 055/009155	FRC-60-C 055/009194	FRC-60-B 055/009158	-	FRC-60-LU -	FRC-54-LU -	FRC-60-S 055/009175
BS 113 (11 x 139 x 158)	FRC-60-F 055/009155	FRC-60-C 055/009194	FRC-60-B 055/009158	-	FRC-60-LU -	FRC-54-LU -	FRC-60-S 055/009175
UIC 54B (20 x 147 x 129)	FRC-54B-F 055/009157	FRC-54B-C 055/009193	FRC-54B-B 055/009160	-	-	-	-
UIC 60B (20 x 140 x 134)	FRC-60B-F 055/009166	FRC-60B-C 055/009192	FRC-60B-B 055/009167	-	-	-	-
BS 95RBH (18 x 69 x 145)	FRC-95-F 055/009168	FRC-95-C 055/09191	FRC-95-B 005/009172	FRC-95-H 055/009169	-	FRC-95-LU -	-

Rail heater fixings

UIC 60, UIC 54, BS 113, BS 110

Designed specifically to suit UIC 60, UIC 54, BS 113 and BS 110 rail section, these rail heater clips are simple to install. Like the rest of the E-Klips® range, they are manufactured from carbon spring steel and finished with our unique Z600+ coating, giving them a market leading level of corrosion resistance.

Foot mount (FRC-60-F)

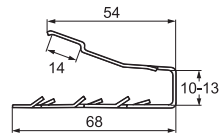

Temp. sensor (FRC-60-S)

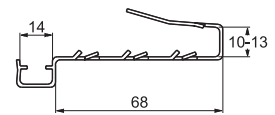
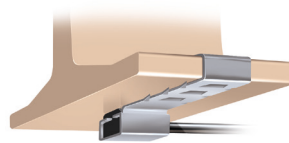

Tie wrap (FRC-60-C)*

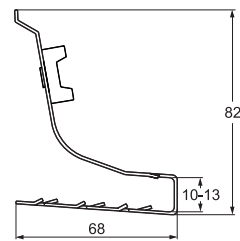
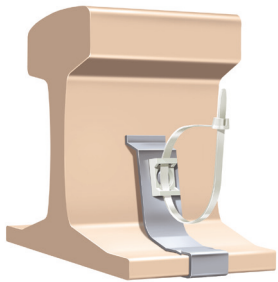

Web mount (FRC-60-W)

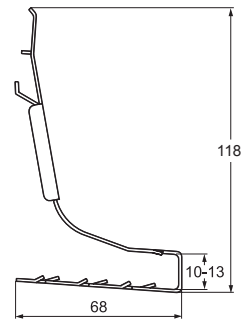
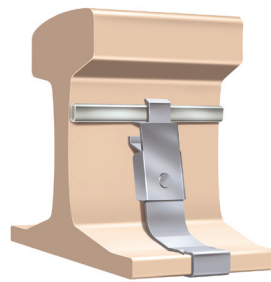

Barrel clamp (FRC-60-B)

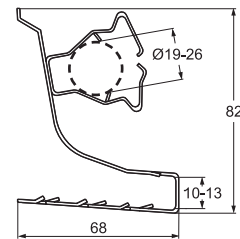
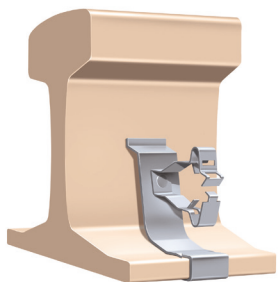

Cable clip (FRC-54-LU)*

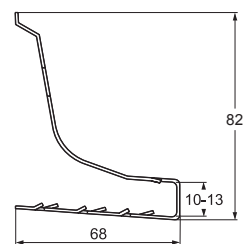
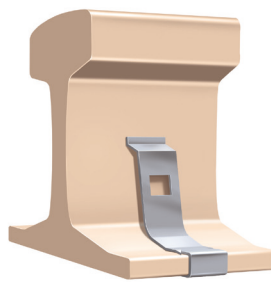

Head mount (FRC-54-H)

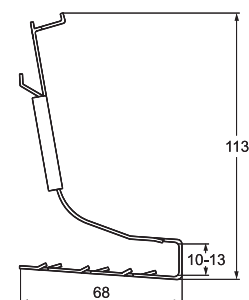
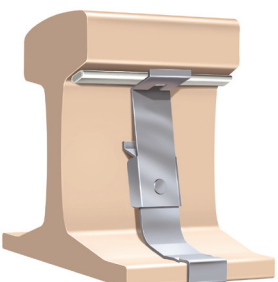

*See page 7 for cable tie & cable clip options.

Rail heater fixings

UIC 60B

Designed specifically to suit the UIC 60B rail section, these rail heater clips are simple to install. Like the rest of the E-Klips® range, they are manufactured from carbon spring steel and finished with our unique Z600+ coating, giving them a market leading level of corrosion resistance.

Foot mount (FRC-60B-F)

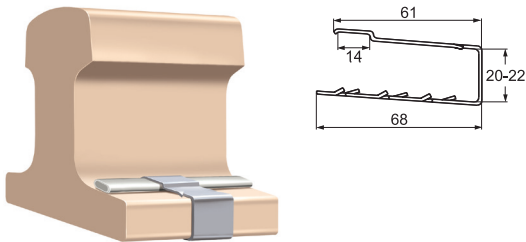

Tie wrap (FRC-60B-C)*

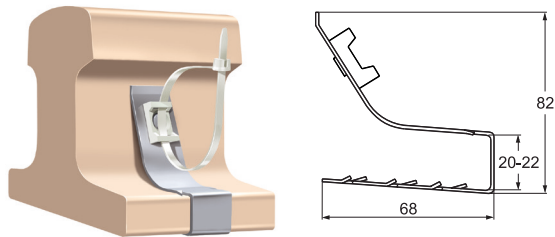

Barrel clamp (FRC-60B-B)

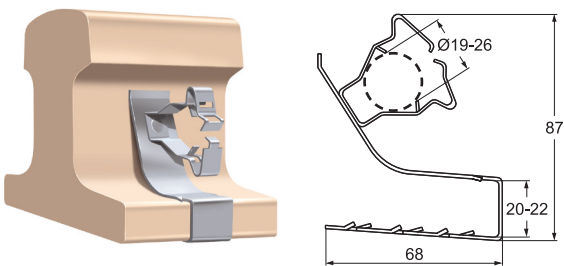

Rail heater fixings

UIC 54B

Designed specifically to suit the UIC 54B rail section, these rail heater clips are simple to install. Like the rest of the E-Klips® range, they are manufactured from carbon spring steel and finished with our unique Z600+ coating, giving them a market leading level of corrosion resistance.

Foot mount (FRC-54B-F)

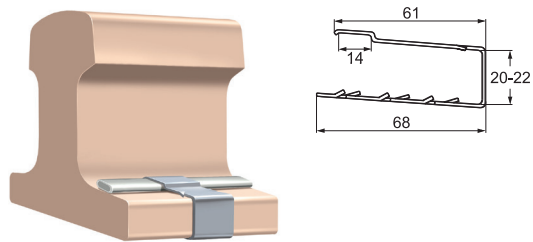

Tie wrap (FRC-54B-C)*

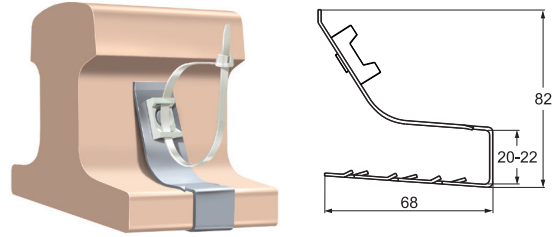

Barrel clamp (FRC-54B-B)

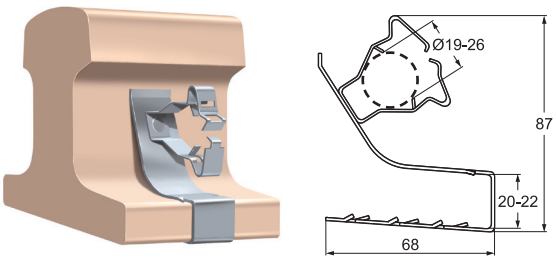

*See page 7 for cable tie options.

Rail heater fixings

BS 95 RBH

Designed specifically to suit the BS 95RBH rail section, these rail heater clips are simple to install (using tool FRC-95-T). Like the rest of the E-Klips® range, they are manufactured from carbon spring steel and finished with our unique Z600+ coating, giving them a market leading level of corrosion resistance.

Foot mount (FRC-95-F)

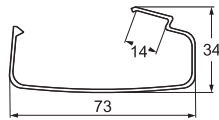
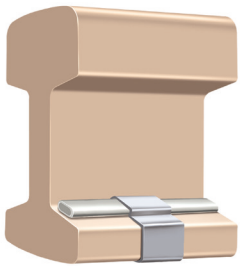

Cable clip (FRC-95-LU)*

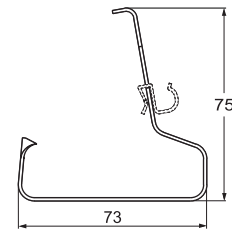
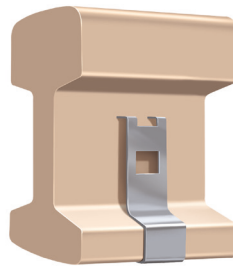

Tie wrap (FRC-95-C)*

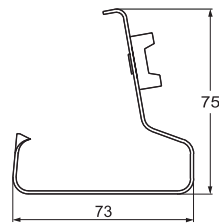
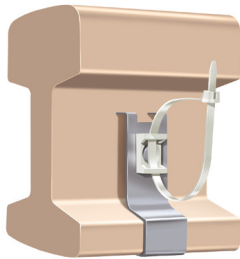

Fixing tool (FRC-95-T)

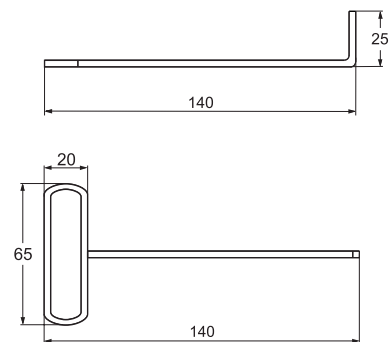

Barrel clamp (FRC-95-B)

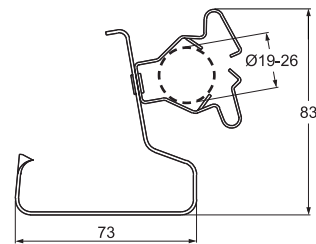
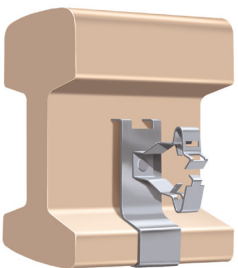

Head mount [FRC-95-H]

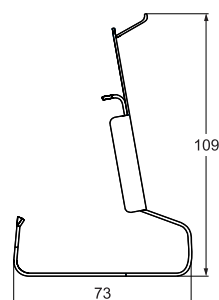
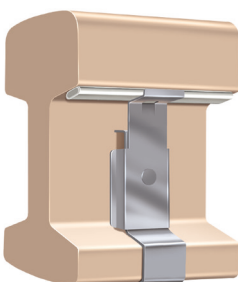

*See page 7 for cable tie & cable clip options.

Cable clips and ties

EH & ECS cable clips and Ty-Rap® cable ties

As well as the clips dedicated to securing heater strips to the rail, additional clips are available for cable management.

EH cable clip

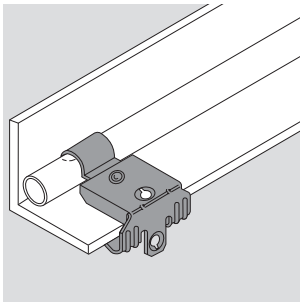

Part No.	T (mm)	A (mm)	Quantity (pieces)
EH38-RCC13	3-8	13	25
EH38-RCC15	3-8	15	25
EH814-RCC13	8-14	13	25
EH814-RCC15	8-14	15	25
EH1420-RCC13	14-20	13	25
EH1420-RCC15	14-20	15	25

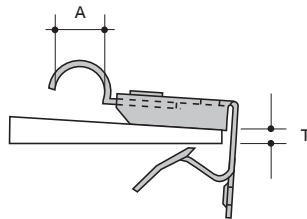

ECS cable clip

For use with rail fixing clip:

- FRC-54-LU
- FRC-95-LU

ECS cable clip

Part No.	A (mm)	Quantity (pieces)
ECS-67	6-7	100
ECS-89	8-9	100
ECS-1011	10-11	100
ECS-1214	12-14	100
ECS-1519	15-19	100
ECS-2024	20-24	100
ECS-2532	25-32	100

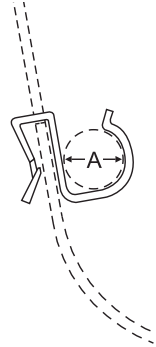

Ty-Rap® Cable ties - Premium cable ties with steel locking barb:

- Manufactured from Polyamide 6.6
- Available in natural and UV resistant black
- Corrosion-proof, 316 grade steel barb anchored inside the tie head guarantees a strong and durable fastening
- Low-profile head allows secure tying in tight spaces
- Vibration and shock proof



Ty-Rap® Cable ties

Part No.	Colour	L (mm)	Bundle dia. (mm)	Quantity (pieces)
TY271M	Natural	150	6-31	500
TY271MX	Black	150	6-31	500
TY272M	Natural	222	6-50	500
TY272MX	Black	222	6-50	500

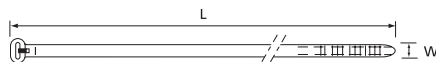

The ERG 297 hand tool both tensions and cuts plastic cable ties. The advanced cutting mechanism allows the strap end of Ty-Rap cable ties to retract in the tie head upon cutting:

- Adjustable tension setting
- Automatic cutting and 360° rotating nose
- Anti-recoil mechanism reduces vibration shock

Tooling

Part No.	Quantity (pieces)
ERG 297	1





—
ABB Installation Products

Wilford Road

Nottingham, UK

NG2 1EB

Tel: +44 (0) 115 964 3700

Fax: +44 (0) 115 986 0538

Sales Tel: +44 (0) 115 964 3800

Sales Fax: +44 (0) 115 986 0071

E-Mail: enquiry@e-klips.com

www.e-klips.com