

PRODUCT BROCHURE

 elastimold™

Advanced shear bolt connection system

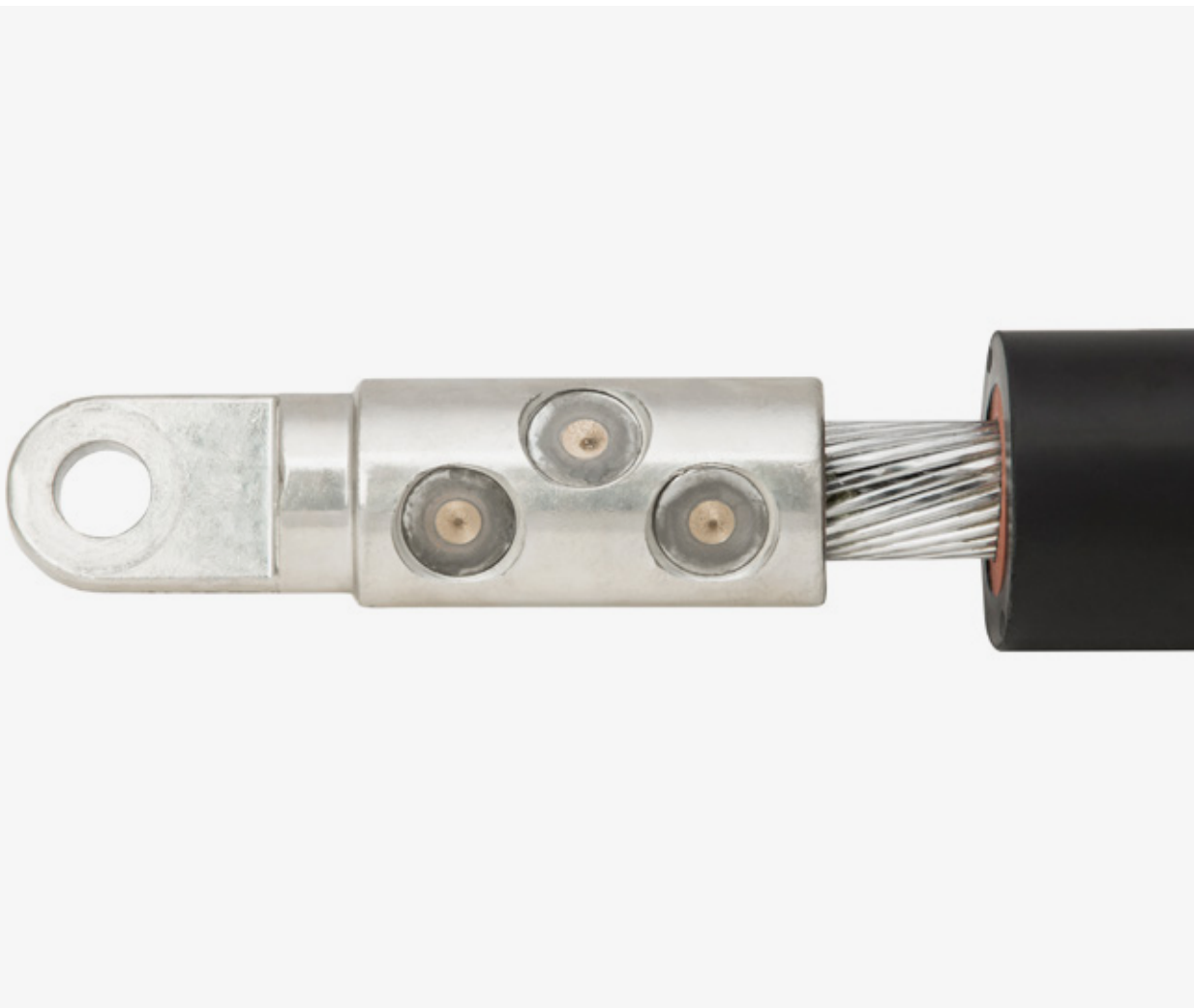

Elastimold™ cable accessories

The Elastimold advanced shear bolt connection system is the latest solution to be incorporated into the Elastimold portfolio of separable connectors. It's consistent with the system's overall purpose in providing safe, reliable and flexible separable connectors for underground cable.



—
01 Elastimold advanced
shear bolt connection
system

Overview

Reliable solution that helps reduce the potential of human error. Bolt heads shear off at the correct torque using a standard wrench. Leaves a smooth, flush finish with no protruding edges.

- Simplifies and speeds installations — only a standard wrench is needed; no dies or pneumatic tools
- Only five range-taking shear bolt connectors are needed to accommodate multiple wire sizes #2 AWG to 1500 kcmil*
- Applicable for 600 amp and 900 amp current rating
- Compatible with aluminum and copper conductors

Applications

Shear bolt connectors are available in a range-taking selection of five sizes, which substantially reduces the chance of accidentally installing the wrong connector.

- IEEE 386 separable connectors
- 600/900 amp elbow connectors, vault stretchers and straight receptacles from 15 kV up to 35 kV
- Aluminum or copper conductors
- Cables from #2 AWG to 1500 kcmil*

Installation

Installation with a standard wrench and no additional components, as well as easy shearing at the correct torque, make the Elastimold advanced shear bolt connection system quick to install, saving time and resources.

- Circuit must be de-energized before installation
- Brush conductor to break up the oxide layer
- Fully insert conductor into barrel
- Torque bolts steadily with wrench until head shears off, beginning with bolt farthest from the connector head and working toward the head
- Follow detailed instructions provided with the product

*1500 kcmil only with 35 kV.

Leaves a smooth finish that fits flush against the body of the connector — no sharp edges.

Benefits

Connectivity

- Increased clamping area results in a tighter, more secure connection

Reliability

- Meets IEEE386 latest revision
- No filing or extra components needed
- Electro tin plated
- Pre-lubricated bolts
- Head always shears off at the required torque, leaving no exposed jagged edges that could potentially injure personnel or equipment
- Special design with grooves for improved contact

Flexibility

- Compatible with Elastimold T-body, vault stretcher and straight receptacles
- Range-taking in each connector
- Installation using a standard wrench and socket
- Designed and tested for use on both aluminum and copper conductors
- Self-centering rings for lower diameter conductor for each connector

—
02 Shear bolt
connector family



Increased clamping area with three set screws.

—
02

Stand-alone shear bolt connectors

Conductor size	A		B		C		D		Part number
	in	mm	in	mm	in	mm	in	mm	
#2–300 kcmil	1.18	30	6.10	155	1.42	36	0.689	17.5	EACT-0300
4/0–500 kcmil	1.30	33	6.10	155	1.42	36	0.689	17.5	EACT-0500
350–750 kcmil	1.65	42	6.10	155	1.42	36	0.689	17.5	EACT-0750
750–1250 kcmil	2.05	52	6.10	155	1.42	36	0.689	17.5	EACT-1250
1500 kcmil	2.36	60	6.69	170	1.30	35	0.689	15.5	EACT-1500

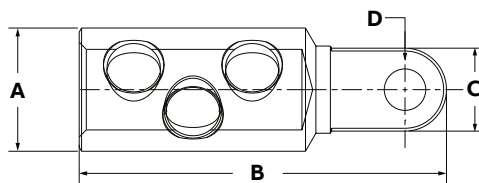

Note: To hold the connector securely in place during the shearing process, it is recommended to use the connector vise, part number CV1000.
*Shear bolt options now available with separable cable joints.

Ordering information

600 amp deadbreak elbow



T-body 600 amp LR kit

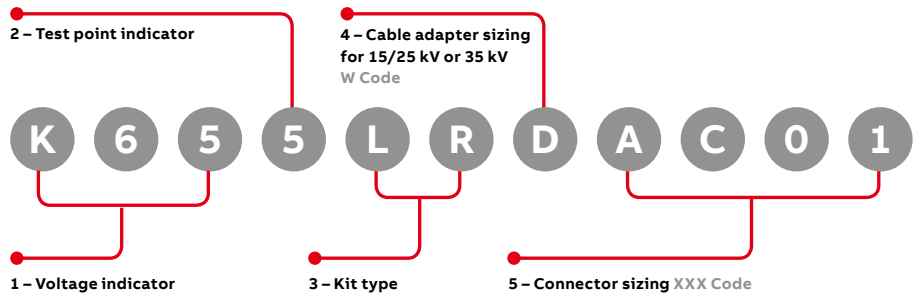

Catalog number selection

Step 1

- Select voltage class and ampacity
- Select the option of capacity test point (with or without)
- Select the kit type

1 - Voltage indicator

Description	Code
600 A 15/25 kV	K 6 5
600 A 35kV	7 5
900 A 15/25 kV	K 6 7
900 A 35kV	7 7

3 - Kit type

Description	Code
Elbow (w/ insul. plug, cap, stud lug and cable adapter)	L R
Direct test elbow (w/ insul. plug, cap, stud lug and cable adapter)	D L R

4 - Cable adapter sizing for 15/25 kV

Table W7				
Cable insulation dia. range				
Cable insulation diameter in inches		Cable insulation diameter in millimeters		Code for W
min	max	min	max	
0.42	0.66	10.7	16.8	D
0.53	0.68	13.5	17.3	E
0.64	0.82	16.3	20.8	F
0.76	0.95	19.3	24.1	G
0.85	1.05	21.6	26.7	H
0.98	1.18	24.9	4.6	J
1.09	1.31	27.7	33.3	K
1.18	1.465	30	37.2	L
1.28	1.43	32.5	36.3	L M
1.37	1.63	34.8	41.4	M
1.55	1.78	39.4	45.2	N
1.725	1.935	43.8	49.1	P

Step 2 (W)

- According to the voltage class, select the proper code for W; for 15/25 kV system use table W7 and for 35 kV use table W9

2 - Test point indicator

Description	Code
No test point	5
With test point	6

4 - Cable adapter sizing for 35 kV

Table W9				
Cable insulation dia. range				
Cable insulation diameter in inches		Cable insulation diameter in millimeters		Code for W
min	max	min	max	
0.76	0.95	19.3	24.1	G
0.85	1.05	21.6	26.7	H
0.98	1.18	24.9	30	J
1.09	1.31	27.7	33.3	K
1.18	1.465	30	37.2	L
1.37	1.63	34.8	41.4	M
1.515	1.78	38.5	45.2	N
1.725	1.935	43.8	49.1	P
1.9	2.12	48.3	53.8	Q
2.115	2.235	53.7	56.8	R

Step 3 (X)

- Choose the proper shear bolt lug code according to the conductor size from the conductor code table
- Insert the code into catalog number

LR and DLR kit contains

- 1 Elbow connector housing
- 1 Shear bolt lug
- 1 Stud
- 1 Insulated plug w/cap
- 3 Tube, lubricant
- 1 Cable adapter

5 - Connector sizing

Table X				
AWG or kcmil				
Stranded/ compressed/ compact	Code			
#2	A C O 1			
#1	A C O 1			
1/0	A C O 1			
2/0	A C O 1			
3/0	A C O 1			
4/0	A C O 1	A C O 2		
250	A C O 1	A C O 2		
300	A C O 1	A C O 2		
350		A C O 2		
400		A C O 2		
450		A C O 2		
500		A C O 2	A C O 3	
550			A C O 3	
600			A C O 3	
650			A C O 3	
700			A C O 3	
750			A C O 3	A C O 4
800				A C O 4
900				A C O 4
1000				A C O 4
1500*				A C O 5

*1500 kcmil — 35 kV only

Ordering information

Separable cable joints

Now available with I, Y's and H's.

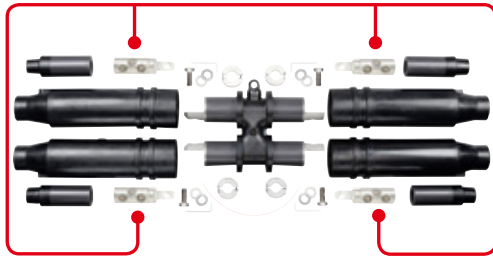

4 Ways compact H shown

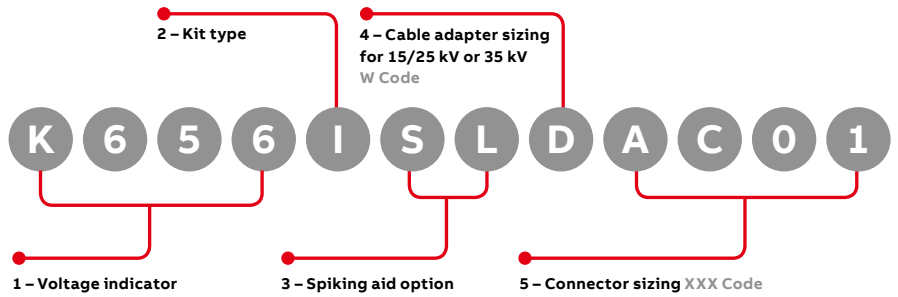

Catalog number selection

Step 1

- Select voltage class
- Select the kit type
- Select spiking aid option

Step 2 (W)

- According to the voltage class, select the proper code for W; for 15/25 kV system use table W7 and for 35 kV use table W9

Step 3 (X)

- Choose the proper shear bolt lug code according to the conductor size from the conductor code table
- Insert the code into catalog number

Each bus bar kit contains

	2 Ways	3 Ways	4 Ways
Bus housing	"I"	"CY"	"CH"
Straight receptacle	2	3	4
Aluminum shear bolt	2	3	4
Adapter retaining ring	2	3	4
Cable adapter	2	3	4

1 - Voltage indicator

Description	Code
600 A 15/25 kV	K 6 5 6
600 A 35kV	M 6 5 6

2 - Kit type

Description	Code
2 Ways	I
3 Ways	C Y
4 Ways	C H

3 - Spiking aid option

Description	Code
Yes	S L
No	Blank

5 - Connector sizing

Table X

AWG or kcmil	Stranded/ compressed/ compact			Code
#2	A C O 1			
#1	A C O 1			
1/0	A C O 1			
2/0	A C O 1			
3/0	A C O 1			
4/0	A C O 1	A C O 2		
250	A C O 1	A C O 2		
300	A C O 1	A C O 2		
350		A C O 2		
400		A C O 2		
450		A C O 2		
500		A C O 2	A C O 3	
550			A C O 3	
600			A C O 3	
650			A C O 3	
700			A C O 3	
750			A C O 3	A C O 4
800				A C O 4
900				A C O 4
1000				A C O 4
1250				A C O 4

4 - Cable adapter sizing for 15/25 kV

Table W7

Cable insulation dia. range		Cable insulation diameter in millimeters		Code for W
min	max	min	max	
0.42	0.66	10.7	16.8	D
0.53	0.68	13.5	17.3	E
0.64	0.82	16.3	20.8	F
0.76	0.95	19.3	24.1	G
0.85	1.05	21.6	26.7	H
0.98	1.18	24.9	4.6	J
1.09	1.31	27.7	33.3	K
1.18	1.465	30	37.2	L
1.28	1.43	32.5	36.3	L M
1.37	1.63	34.8	41.4	M
1.55	1.78	39.4	45.2	N
1.725	1.935	43.8	49.1	P

4 - Cable adapter sizing for 35 kV

Table W9

Cable insulation dia. range		Cable insulation diameter in millimeters		Code for W
min	max	min	max	
0.76	0.95	19.3	24.1	G
0.85	1.05	21.6	26.7	H
0.98	1.18	24.9	30	J
1.09	1.31	27.7	33.3	K
1.18	1.465	30	37.2	L
1.37	1.63	34.8	41.4	M
1.515	1.78	38.5	45.2	N
1.725	1.935	43.8	49.1	P
1.9	2.12	48.3	53.8	Q
2.115	2.235	53.7	56.8	R

Ordering information

Vault stretcher



Stacked vault stretcher 3 ways kit

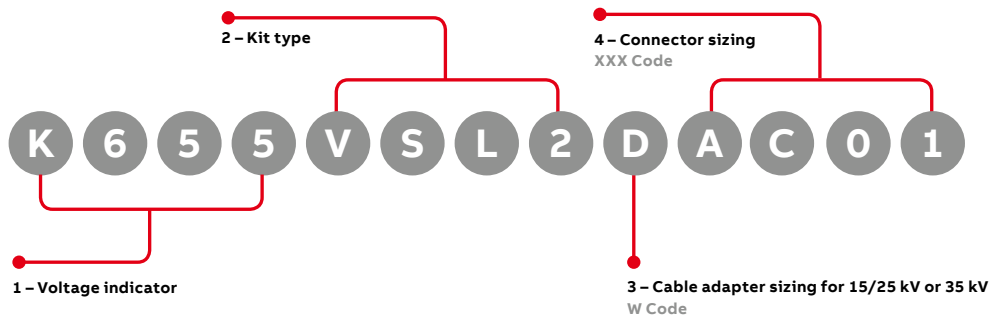

Catalog number selection

Step 1

- Select voltage class and ampacity
- Select the kit type

Step 2 (W)

- According to the voltage class, select the proper code for W; for 15/25/35 kV system use table W7

Step 3 (X)

- Choose the proper shear bolt lug code according to the conductor size from the conductor code table
- Insert the code into catalog number

Each vault stretcher kit contains

	2 Ways	3 Ways	4 Ways
Vault stretcher housing	1	1	2
T-body housing		1	
Aluminum shear bolt	2	3	4
Connecting plug		1	1
Cable adapter	2	3	4
Insulated plug with cap	2	2	2

1 - Voltage indicator

Description	Code
600 A 15/25 kV	K 6 5 5
600 A 35kV	7 5 5
900 A 15/25 kV	K 6 7 5
900 A 35kV	7 7 5

2 - Kit type

Description	Code
2 Ways	V S L 2
3 Ways	V S L 3
4 Ways	V S L 4

3 - Cable adapter sizing for 15/25/35 kV

Cable insulation dia. range		Cable insulation diameter in millimeters		Code for W
min	max	min	max	
0.42	0.66	10.7	16.8	D
0.53	0.68	13.5	17.3	E
0.64	0.82	16.3	20.8	F
0.76	0.95	19.3	24.1	G
0.85	1.05	21.6	26.7	H
0.98	1.18	24.9	4.6	J
1.09	1.31	27.7	33.3	K
1.18	1.465	30	37.2	L
1.28	1.43	32.5	36.3	L M
1.37	1.63	34.8	41.4	M
1.55	1.78	39.4	45.2	N
1.725	1.935	43.8	49.1	P

4 - Connector sizing

Table X

AWG or kcmil	Code			
Stranded/ compressed/ compact	A	C	0	1
#2	A	C	0	1
#1	A	C	0	1
1/0	A	C	0	1
2/0	A	C	0	1
3/0	A	C	0	1
4/0	A	C	0	1
250	A	C	0	1
300	A	C	0	1
350		A	C	0
400		A	C	0
450		A	C	0
500		A	C	0
550		A	C	0
600		A	C	0
650		A	C	0
700		A	C	0
750		A	C	0
800			A	C
900			A	C
1000			A	C
1500*				A

*1500 kcmil — 35 kV only

Ordering information

Combo T



Elastimold advanced connection system

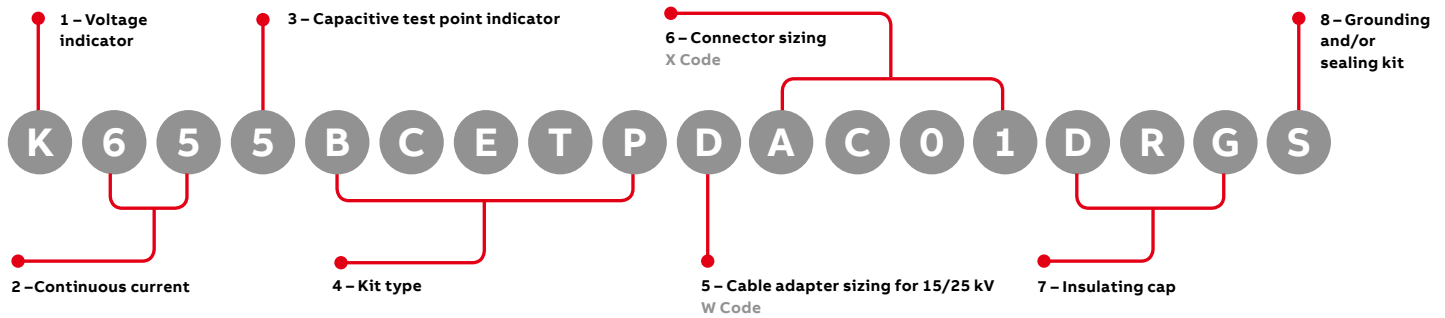

1 – Voltage indicator

Description	Code
15kV CETP only	(Blank)
25kV CETP only	K
15/25kV	K

2 – Continuous current

Description	Code
600Amp (base aluminum)	6 5
900Amp (copper)	6 7

3 – Capacitive test point indicator

Description	Code
No test point	5
Includes test point	6

4 – Kit type

Description	Code
Basic Combo T elbow reducing tap plug with stud	B C E T P
Combo T elbow reducing tap plug with stud, cable adapter, lug, and insulated cap kit	C E T P
Basic Combo T connecting plug with stud	B C C P
Combo T connecting plug with stud, cable adapter, and lug kit	C C P
Basic Combo T bushing well with stud	B C B W
Combo T bushing well with stud, cable adapter, and lug kit	C B W

5 – Cable adapter sizing for 15/25 kV

Table W7				
Cable insulation dia. range				
Cable insulation diameter in inches		Cable insulation diameter in millimeters		Code for W
min	max	min	max	
0.42	0.66	10.7	16.8	D
0.53	0.68	13.5	17.3	E
0.64	0.82	16.3	20.8	F
0.76	0.95	19.3	24.1	G
0.85	1.05	21.6	26.7	H
0.98	1.18	24.9	4.6	J
1.09	1.31	27.7	33.3	K
1.18	1.465	30	37.2	L
1.28	1.43	32.5	36.3	L M
1.37	1.63	34.8	41.4	M
1.55	1.78	39.4	45.2	N
1.725	1.935	43.8	49.1	P

6 – Connector sizing

Table X										
AWG or kcmil										
Stranded/ compressed/ compact	Code									
	A	C	O	1						
#2	A	C	O	1						
#1	A	C	O	1						
1/0	A	C	O	1						
2/0	A	C	O	1						
3/0	A	C	O	1						
4/0	A	C	O	1	A	C	O	2		
250	A	C	O	1	A	C	O	2		
300	A	C	O	1	A	C	O	2		
350		A	C	O	2					
400		A	C	O	2					
450		A	C	O	2					
500		A	C	O	2	A	C	O	3	
550			A	C	O	3				
600			A	C	O	3				
650			A	C	O	3				
700			A	C	O	3				
750			A	C	O	3	A	C	O	4
800				A	C	O	4			
900				A	C	O	4			
1000				A	C	O	4			
1250				A	C	O	4			

7 – Insulating cap

Description	Code
None	(Blank)
With insulated cap	D R G
With bushing well plug	B W P

8 – Grounding and/or sealing kit

Description	Code
None	(Blank)
Shrink-fit jacket seal kit	9
Shrink-fit jacket seal kit with copper braid and constant force spring	5 G 3



—
US

ABB Installation Products Inc.
Electrification business

electrification.us.abb.com
tnb.abb.com

—
We reserve the right to make technical changes or modify the contents of this document without prior notice. With regard to purchase orders, the agreed particulars shall prevail. ABB Installation Products Inc. does not accept any responsibility whatsoever for potential errors or possible lack of information in this document.

We reserve all rights in this document and in the subject matter and illustrations contained therein. Any reproduction or utilization of its contents – in whole or in parts – is forbidden without prior written consent of ABB Installation Products Inc. © 2020 ABB Installation Products Inc. and/or its related companies. All rights reserved