

Navigator 540

Transmitter



Measurement made easy

— Navigator 540 transmitter

Introduction

The Navigator 500 range of analyzers from ABB are designed for high purity water treatment applications and power cycle chemistry monitoring.

The analysis and signal conditioning is conducted within the Navigator 550's advanced wet-section that houses the sensing technology. The accurate measurement result is transmitted digitally to the Navigator AWT540 transmitter.

The following parameters are available in the Navigator 500 range:

- Dissolved oxygen
- Hydrazine
- Sodium

This publication provides PROFIBUS®, Modbus® and Ethernet connection/configuration details together with PROFIBUS and Modbus reference tables for the Navigator AWT540 transmitter.

For more information

Further publications for the Navigator 500 series are available for free download from

www.abb.com/analytical

or by scanning these codes:



Navigator ADS550
Dissolved oxygen
analyzer



Navigator AHM550
Hydrazine analyzer



Navigator ASO550
Sodium analyzer

Search for or click on

Navigator 500 dissolved oxygen analyzer	Data Sheet Navigator 500 Dissolved oxygen analyzer	DS/ADS550-EN
	Commissioning Instruction Navigator 550 Low level dissolved oxygen wet-section	CI/ADS550-EN
	Operating Instruction Navigator 500 Low level dissolved oxygen analyzer	OI/ADS550-EN
	Data Sheet Navigator 500 Hydrazine analyzer	DS/AHM550-EN
	Commissioning Instruction Navigator 550 Hydrazine wet-section	CI/AHM550-EN
	Operating Instruction Navigator 500 Hydrazine analyzer	OI/AHM550-EN
Navigator 500 sodium analyzer	Data Sheet Navigator 500 Sodium analyzer	DS/ASO550-EN
	Commissioning Instruction Navigator 550 Sodium wet-section	CI/ASO550-EN
	Operating Instruction Navigator 500 Sodium analyzer	OI/ASO550-EN
	Addendum RoHS Directive 2011/65/EU (RoHS II)	ADD/MEASUREMENT/001-EN

Contents

1 Health & Safety	4	A.1.7 Slot 1 – multistream sensor diagnostics	19
1.1 Document symbols	4	A.1.8 Slot 1 – relay status	20
1.2 Safety precautions	4	A.1.9 Slot 1 – alarm status	20
1.3 Potential safety hazards	4	A.1.10 Slot 1 – digital I/O status	20
1.3.1 Navigator AWT540 transmitter – electrical	4	A.2 Alarm acknowledge	21
1.4 Safety standards	4	A.2.1 Slot 2 – alarm acknowledge	21
1.5 Product symbols	5	A.3 Action commands	21
1.6 Product recycling and disposal (Europe only)	5	A.3.1 Slot 3 – action commands	21
1.6.1 End-of-life battery disposal	5	A.4 Read-only, float	22
1.7 Restriction of Hazardous Substances (RoHS)	5	A.4.1 Slot 4 – measured values	22
		A.4.2 Slot 4 – range limits	23
		A.4.3 Slot 4 – analog O/P values	23
2 Communications overview	6	A.5	24
2.1 Cyber security	6	A.5.1 Slot 5 – device info	24
2.2 Ethernet	6	A.6	24
2.3 RS485 Modbus	6	A.6.1 Slot 6 – device info	24
2.4 PROFIBUS	6	A.7	25
2.4.1 PROFIBUS DP	6	A.7.1 Slot 7 – sensor type and hardware options	25
2.4.2 PROFIBUS and ABB products	6	A.8	26
		A.8.1 Slot 8 – device info	26
3 Communication level	7	A.9 Not used	26
		A.10	26
4 PROFIBUS communications	8	A.10.1 Slot 10 – device configuration	26
4.1 PROFIBUS DP transmission technology	8	A.10.2 Slot 10 – alarm settings	27
4.2 Acronyms and abbreviations	8	A.10.3 Slot 10 – analog output settings	27
4.3 PROFIBUS interface	8	A.11	28
4.4 Installation	8	A.11.1 Slot 11 – sensor settings	28
4.4.1 Installation overview	8	A.11.2 Slot 11 – alarm time and hysteresis	28
4.4.2 Cable length	9	A.12	29
4.4.3 Cable specification	9	A.12.1 Slot 12 – single stream sensor configuration	29
4.5 Network connection	9	A.12.2 Slot 12 – multi stream sensor configuration	33
4.5.1 Terminal block network connections	9	A.12.3 Slot 12 – operator page template	34
4.6 Configuration	10	A.12.4 Slot 12 – view/log enables	34
4.6.1 Setting the PROFIBUS station address	10	A.12.5 Slot 12 – date/time settings	35
4.6.2 Integration using GSD	10	A.12.6 Slot 12 – alarm settings	36
4.6.3 Configuration from the Navigator AWT540 transmitter	11	A.12.7 Slot 12 – analog output settings	37
4.7 Navigator AWT540-DP PROFIBUS datasheet	11	A.12.8 Slot 12 – digital I/O settings	38
4.8 Declaration of PROFIBUS conformance	12	A.12.9 Slot 12 – relay settings	39
		A.13	39
		A.13.1 Slot 13 – tags	39
5 Modbus communications	13	Appendix B – Modbus tables	40
5.1 Host computer serial communications	13	B.1 Register tables	40
5.2 Two-wire and four-wire connection	14	B.2 Digital I/O status	41
5.3 Pull-up and pull-down resistors	14	B.3 Alarm acknowledgement	41
5.4 Termination resistor	14	B.4 Action commands	41
5.5 Serial connections	14	B.5 Read-only, single precision float	41
		B.6 Read-only, 32 bits	43
6 Ethernet communications	15	B.7 Read-only, 16 bits	43
6.1 Ethernet connection	15	B.8 Read-only 8 bits	44
		B.9 Read-only strings	44
Appendix A – PROFIBUS tables	16	B.10 Writable floats	45
A.1 Module definitions in GSD file for cyclic read	16	B.11 Writable, 16 bits	46
A.1.1 Slot 1 – digital inputs	16	B.12 Writable, 8 bits	46
A.1.2 Slot 1 – transmitter diagnostics	16	B.13 Writable strings	51
A.1.3 Slot 1 – sensor 1/stream 1 diagnostics	17		
A.1.4 Slot 1 – sensor 2/stream 2 diagnostics	17	Appendix C – Ranges and signals	52
A.1.5 Slot 1 – sensor 3/stream 3 diagnostics	18		
A.1.6 Slot 1 – sensor 4/stream 4 diagnostics	18		

1 Health & Safety

1.1 Document symbols

Symbols that appear in this document are explained below:



DANGER – Serious damage to health / risk to life

This symbol in conjunction with the signal word 'DANGER' indicates an imminent electrical hazard. Failure to observe this safety information will result in death or severe injury.



WARNING – Bodily injury

This symbol in conjunction with the signal word 'WARNING' indicates a potential electrical hazard. Failure to observe this safety information will result in death or severe injury.



CAUTION – Minor injuries

This symbol in conjunction with the signal word 'CAUTION' indicates a potentially dangerous situation. Failure to observe this safety information may result in minor or moderate injury. The symbol may also be used for property damage warnings.



NOTICE – Property damage

This symbol indicates a potentially damaging situation. Failure to observe this safety information may result in damage to or destruction of the product and / or other system components.



IMPORTANT (NOTE)

This symbol indicates operator tips, particularly useful information or important information about the product or its further uses. The signal word 'IMPORTANT (NOTE)' does not indicate a dangerous or harmful situation.

1.2 Safety precautions

Be sure to read, understand and follow the instructions contained within this manual before and during use of the equipment. Failure to do so could result in bodily harm or damage to the equipment.



WARNING – Bodily injury Installation, operation, maintenance and servicing must be performed:

- by suitably trained personnel only
 - in accordance with the information provided in this manual
 - in accordance with relevant local regulations
-

1.3 Potential safety hazards

1.3.1 Navigator AWT540 transmitter – electrical



WARNING – Bodily injury

To ensure safe use when operating this equipment, the following points must be observed:

- Up to 240 V AC may be present. Be sure to isolate the supply before removing the terminal cover.
- Normal safety precautions must be taken to avoid the possibility of an accident occurring when operating in conditions of high pressure and / or temperature.







Safety advice concerning the use of the equipment described in this manual or any relevant Material Safety Data Sheets (where applicable) can be obtained from the Company, together with servicing and spares information.

1.4 Safety standards

This product has been designed to satisfy the requirements of IEC61010-1:2010 3rd edition 'Safety Requirements for Electrical Equipment for Measurement, Control and Laboratory Use' and complies with US NEC 500, NIST and OSHA.

1.5 Product symbols

Symbols that appear on this product are shown below:

	Functional earth (ground) terminal.
	Alternating current supply only.
	This symbol, when noted on a product, indicates a potential hazard which could cause serious personal injury and / or death. The user should reference this instruction manual for operation and / or safety information.
	This symbol, when noted on a product enclosure or barrier, indicates that a risk of electrical shock and / or electrocution exists and indicates that only individuals qualified to work with hazardous voltages should open the enclosure or remove the barrier.
	The equipment is protected through double insulation.
	Recycle separately from general waste under the WEEE directive.

1.6 Product recycling and disposal (Europe only)



ABB is committed to ensuring that the risk of any environmental damage or pollution caused by any of its products is minimized as far as possible. The European Waste Electrical and Electronic Equipment (WEEE) Directive that initially came into force on 13 August 2005 aims to reduce the waste arising from electrical and electronic equipment; and improve the environmental performance of all those involved in the life cycle of electrical and electronic equipment. In conformity with European local and national regulations, electrical equipment marked with the above symbol may not be disposed of in European public disposal systems after 12th August 2005.



IMPORTANT (NOTE) For return for recycling, please contact the equipment manufacturer or supplier for instructions on how to return end-of-life equipment for proper disposal.

1.6.1 End-of-life battery disposal

The transmitter contains a small lithium battery (located on the processor / display board) that must be removed and disposed of responsibly in accordance with local environmental regulations.

1.7 Restriction of Hazardous Substances (RoHS)



The European Union RoHS Directive and subsequent regulations introduced in member states and other countries limits the use of six hazardous substances used in the manufacturing of electrical and electronic equipment. Currently, monitoring and control instruments do not fall within the scope of the RoHS Directive, however ABB has taken the decision to adopt the recommendations in the Directive as the target for all future product design and component purchasing.

2 Communications overview

Extensive communication options enable the Navigator AWT540 transmitter to be integrated into larger control systems easily or connected to other process instrumentation. The following sub-sections describe the options available.

2.1 Cyber security

This product is designed to be connected to and to communicate information and data via a digital communication interface. It is your sole responsibility to provide and continuously ensure a secure connection between the product and your network or any other network (as the case may be). You shall establish and maintain any appropriate measures (such as but not limited to the application of authentication measures etc.) to protect the product, the network, its system and the interface against any kind of security breaches, unauthorized access, interference, intrusion, leakage and/or theft of data or information.

ABB Ltd and its affiliates are not liable for damages and/or losses related to such security breaches, any unauthorized access, interference, intrusion, leakage and/or theft of data or information.

The Modbus protocol is an unsecured protocol, as such the intended application should be assessed to ensure that these protocols are suitable before implementation.

The PROFIBUS PA protocol is an unsecured protocol, as such the intended application should be assessed to ensure that these protocols are suitable before implementation.

The PROFIBUS DP protocol is an unsecured protocol, as such the intended application should be assessed to ensure that these protocols are suitable before implementation.

2.2 Ethernet

Optional Ethernet communications enable the Navigator AWT540 to be integrated in to an Ethernet network quickly.

The following functionality is provided:

- **Email**
Notification of a critical process event or status can be made by email. Multiple events can trigger an email that can be sent to multiple recipients.
- **Webserver**
Navigator AWT540's integrated webserver enables the current status of the process and controller to be viewed remotely using a standard web browser.

2.3 RS485 Modbus

Using RS485 Modbus, values and status can be communicated between a master (or host) computer and the Navigator AWT540 in real-time via an RS485 connection.

2.4 PROFIBUS

PROFIBUS is a manufacturer-independent, open Fieldbus standard for a wide range of applications in manufacturing, process and building automation. Manufacturer independence and openness are ensured by the international standard EN 50170.

Using the PROFIBUS protocol, devices from different manufacturers exchange information on the same communications bus without the need for special interface equipment.

For further information on PROFIBUS, refer to: www.profibus.com.

2.4.1 PROFIBUS DP

PROFIBUS DP is designed for high-speed data exchange and is commonly used by complex or externally-powered devices. The central controller or 'master' device (for example, PLC or PC) utilizes PROFIBUS DP as a fast serial connection with distributed (slave) PROFIBUS-enabled field devices.

The master device reads the input information cyclically in a defined, recurring order from the slave(s). When configuring the bus system, the user assigns an address in the range 0 to 125 to each slave device and also defines which of the slaves are to be included in, or excluded from, the data acquisition cycle.



2.4.2 PROFIBUS and ABB products

Navigator AWT540 utilizes PROFIBUS DP as this protocol is optimized for high speed and low connection costs (see www.abb.com/fieldbus and follow the PROFIBUS link).

3 Communication level

i IMPORTANT (NOTE) *Communication* level menus are enabled only if an optional communications module is fitted and the parameters displayed are specific to the type of module fitted. For example, if a Modbus module is fitted, Modbus parameters are enabled, but Ethernet parameters are neither enabled nor displayed.

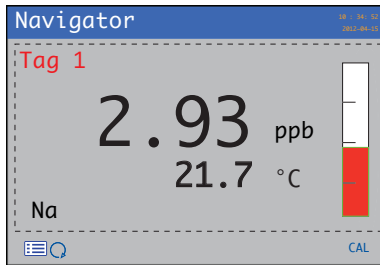

The *Communication* level is accessed from the *Advanced* access level. To access the communication level and the configuration parameters for the communications module fitted:

1. Press the  key (below the  icon on any *Operator* page).



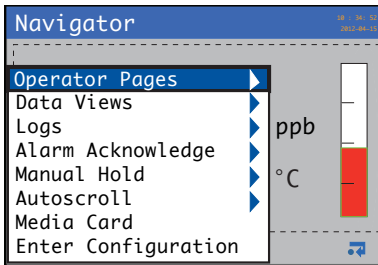

The *Operator* menu is displayed:



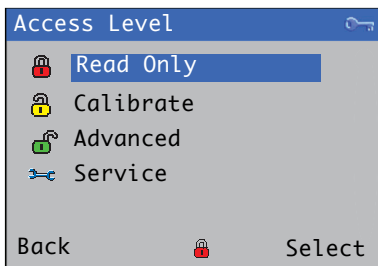

2. Press the  key to scroll to *Enter Configuration* and press the  key.

The *Access Level* page is displayed:



3. Use the  key to scroll to *Advanced* and press the  key (below the *Select* prompt).

4. Use the  and  keys to scroll to the *Communication* level:

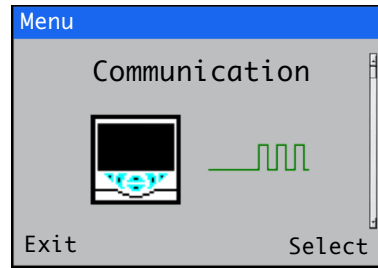

5. Press the  key (below the *Select* prompt).

The *Communication* page appropriate to the communication module fitted is displayed:

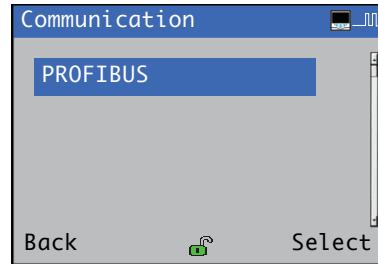

PROFIBUS – refer to Section 4, page 8.

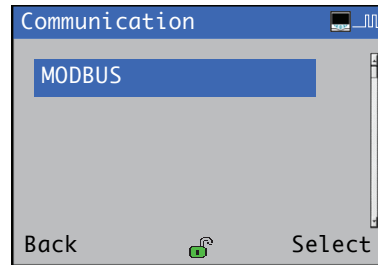

MODBUS – refer to Section 5, page 13.

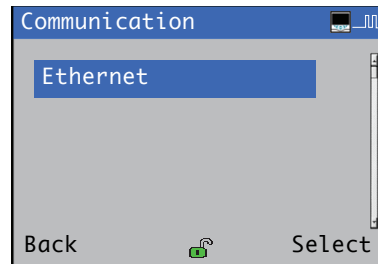

Ethernet – refer to Section 6, page 15.

4 PROFIBUS communications

This section contains information specific to the PROFIBUS®-enabled Navigator AWT540 with RS485 physical layer.

It must be read in conjunction with the associated Operating instructions:

- Sodium: OI/ASO550-EN
- Dissolved oxygen: OI/ADS550-EN
- Hydrazine: OI/AHM550-EN

Refer the associated data sheets for details of specific order codes:

- Sodium: DS/ASO550-EN
- Dissolved oxygen: DS/ADS550-EN
- Hydrazine: DS/AHM550-EN

4.1 PROFIBUS DP transmission technology

The most common transfer method of PROFIBUS-DP is RS485 – a proven technology. A twisted, shielded, 2-wire copper cable is used as the transfer medium.

The bus structure enables addition and removal of stations or step-by-step commissioning of the system without affecting other stations. Later expansion has no influence on stations already in operation.

Transmission speeds from 9.6 kbps up to 12 Mbps are supported. One uniform transmission speed is selected for all devices on the bus when the system is commissioned.

4.2 Acronyms and abbreviations

Input	Data passed into a Master device (for example, from a Slave device)
I&M	PROFIBUS identification and maintenance function
MS1	Class 1 Master-Slave acyclic transaction
Output	Data passed out of a Master device (for example, to a Slave device)
PCS/DCS	Process control system / distributed control system
PI/PNO	PROFIBUS International / PROFIBUS User Organization (www.profibus.com)

Table 4.1: Acronyms and abbreviations

4.3 PROFIBUS interface

Physical layer	RS485
Supported baud rates	9.6 kbps to 12 Mbps
Supported DP Protocol services	DPV0, DPV1
Concurrent MS2 connections	2
Device stub length	250 mm (9.8 in.)
Master components available	GSD

Table 4.2: PROFIBUS interface

4.4 Installation

4.4.1 Installation overview

All devices are connected in a bus structure ('line') as shown in Fig 4.1. Up to 32 stations (master or slaves) can be linked to create one 'segment', although it is recommended not to install more than 16 devices on a single segment.

Each end of a segment must be terminated by an active bus terminating resistor. Both bus terminators must always be powered to ensure fault-free operation, therefore it is strongly recommended that they are connected to a back-up power supply. The use of bus amplifiers (repeaters) and segment couplers can be used to extend the network.

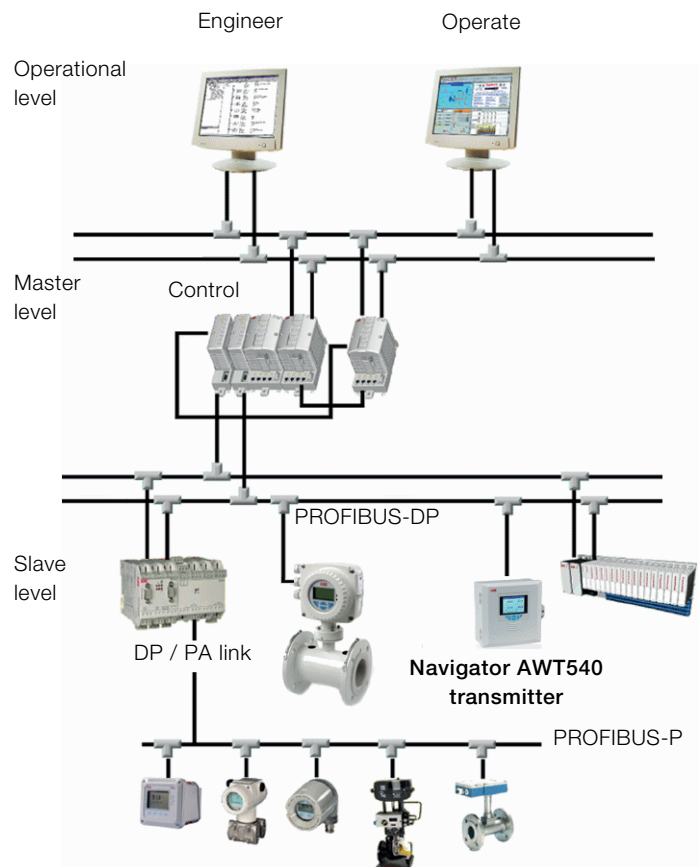

Fig. 4.1: Typical PROFIBUS network

4.4.2 Cable length

The maximum cable length of a segment is determined by the transmission speed (see Table 4.3). The cable length specified can be extended using repeaters, but it is recommended that no more than 3 repeaters are connected in series.

Transmission rate	Maximum segment length (m [ft.])	Maximum total network length (m [ft.])
9.6 to 93.75 kbps	1200 (3937)	4800 (15748)
187.5 kbps	1000 (3280)	4000 (13123)
500 kbps	400 (1312)	1600 (5249)
1.5 Mbps	200 (656)	800 (2624)
3 to 12 Mbps	100 (328)	400 (1312)

Table 4.3: Cable length

4.4.3 Cable specification

The cable lengths in Table 4.3 refer to the following cable type:

Characteristic impedance	135 to 165 Ω
Capacitance per unit length	<30 pf/m
Loop resistance	110 Ω /km
Core diameter	0.64 mm
Core cross section	>0.34 mm ²

Table 4.4: Cable Specification

Suitable PROFIBUS cable (part numbers PCA010, PCA011 and PCA012) can be obtained from ABB. Refer to Data Sheet 10/63-6.46 EN.

4.5 Network connection



WARNING – Bodily injury

When connecting a Navigator AWT540 to a PROFIBUS-DP RS485 network:

- Refer to the Navigator AWT540 Operating instructions before making electrical connections and for all other installation and connection details:
 - Sodium: OI/ASO550-EN
 - Dissolved oxygen: OI/ADS550-EN
 - Hydrazine: OI/AHM550-EN
- Use cable that meets PROFIBUS specifications for reliable RS485 communications.
- Ensure RS485 signals are not reversed.
- Ensure a PROFIBUS active terminator is fitted each end of the RS485 bus segment.
- Route data lines clear of the source of any strong electrical and magnetic fields.

4.5.1 Terminal block network connections

PROFIBUS network connections are made to the terminal blocks on the Navigator AWT540 PCB located behind the PCB terminal cover – refer to the transmitter connections section in the Operating instructions:

- Sodium: OI/ASO550-EN
- Dissolved oxygen: OI/ADS550-EN
- Hydrazine: OI/AHM550-EN

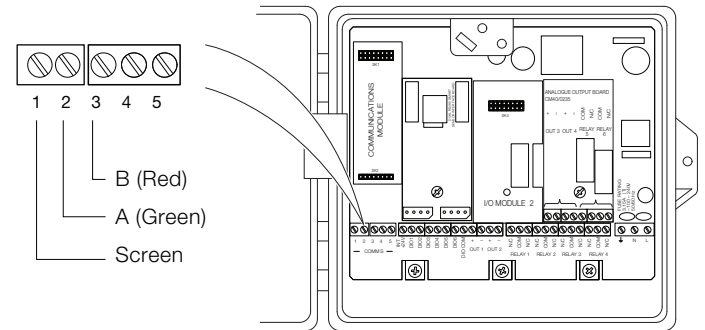

Fig. 4.2: Navigator AWT540 PCB connections to PROFIBUS network

Data signal	Cable color	Description
A	Green	Negative (–) data line: connect to pin 8 on PROFIBUS DP equipment with 9-way D-type connectors.
B	Red	Positive (+) data line: connect to pin 3 on PROFIBUS DP equipment with 9-way D-type connectors.
Braided screen	N / A	Cable screen – usually connected to the D-type shell or pin 1 on PROFIBUS DP equipment with 9-way D-type connectors.

Table 4.5: PROFIBUS DP data cable signals

4.6 Configuration

4.6.1 Setting the PROFIBUS station address

The PROFIBUS station address for a Navigator AWT540 transmitter can be set locally via the keypad and menus or remotely by a master using the SET_SLAVE_ADDRESS service.

When the PROFIBUS Master sets the transmitter's station address, the address is stored and overwrites the address value previously held in the instrument.

i IMPORTANT (NOTE) The transmitter reboots after its PROFIBUS station address parameter is changed. During this period it is not visible to any PROFIBUS masters.

To change the *Station Address*:

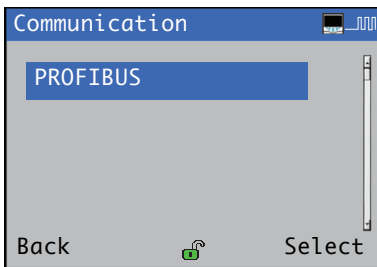

1. Access the PROFIBUS *Communication* page – see Section 3, page 7.



2. Press the  key (below the *Select* prompt).

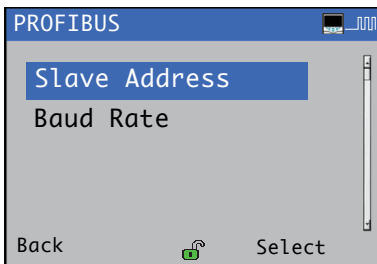



The *PROFIBUS* page is displayed:







3. Use the  and  keys to scroll to *Slave Address* and press the  key (below the *Select* prompt).

i IMPORTANT (NOTE) The *Baud Rate* is a read-only value.

The current *Slave Address* setting (for example 70) is displayed.

4. Press the  key to enter the *Slave Address* edit page.
5. Use the  key to move between editable numbers and use the  and  keys to increment / decrement each number.

Press the  key to accept the new value and exit the *Station Address* page, then press the  key repeatedly to return to the *Operator* page.

i IMPORTANT (NOTE) To cancel a changed value, press and hold the  (*Next*) key (or press repeatedly) until the **Cancel** prompt is displayed at the bottom right side of the page, then press the  key to return to the previous page.

4.6.2 Integration using GSD

PROFIBUS devices differ with respect to available functionality and parameters for each device type and manufacturer. In order to obtain 'Plug-and-Play' configuration for PROFIBUS, characteristic device communication features such as manufacturer name, device name, hardware / software versions, baud rate and the number and nature of inputs / outputs are defined in an electronic device data sheet known as a GSD (Generic Station Description) file.

A GSD file is readable ASCII text file that contains both general and device-specific specifications for communication. Each of the entries describes a feature supported by a device. By using keywords, a configuration tool reads the device identification, the adjustable parameters, the corresponding data type and the permitted limit values for the configuration of the device from the GSD. Some keywords are mandatory, for example, *Vendor_Name*; others are optional, for example, *Sync_Mode_supported*.

The GSD file for Navigator AWT540 transmitters specifies the device-specific Ident No. 3402. It conforms to the PROFIBUS standard, providing a clear and comprehensive description of each instrument in a precisely defined format. This enables the system configuration tool to use the information automatically when configuring a PROFIBUS bus system.

The ABB GSD file (Ident No. 3402) is divided into 2 sections:

– **General specifications**

Identification of the device, together with hardware and software versions, baud rates supported and the possible time intervals for monitoring times.

– **DP Slave-related specifications**

Information about the user parameter block for device-specific configuration and modules containing details of the input and output data that can be exchanged cyclically with a PROFIBUS master.

The Navigator AWT540 GSD file (ABB_3402.gsd) is available for download from the ABB website at: www.abb.com/fieldbus (follow the link for PROFIBUS DP field devices).

4.6.3 Configuration from the Navigator AWT540 transmitter
 PROFIBUS-related parameters are configured from the Navigator AWT540's *Communication / PROFIBUS* page – see Section 3, page 7 for access details.

PROFIBUS parameters are readable at all access levels. Write access to secure (writable) parameters is possible only at *Advanced* level. Refer to associated Operating instructions (OI/ASO550-EN [sodium], OI/ADS550-EN [dissolved oxygen], OI/AHM550-EN [hydrazine]) for details of *Access Level* page parameters.

PROFIBUS parameters options are described in Table 4.6.

Parameter	Description
Station Address	Sets the PROFIBUS <i>Station Address</i> value – see Section 4.6.1, page 10.
Baud Rate	Indicates the baud rate (in kbps) the transmitter has locked on to (read-only parameter).

Table 4.6: PROFIBUS parameter descriptions

4.7 Navigator AWT540-DP PROFIBUS datasheet

Item	Detail
PROFIBUS device name	NAVIGATOR 500 (product: Navigator AWT540)
Applicable standards	IEC61158 (Type 3) IEC61784 (CPF3/1)
Protocols supported	PROFIBUS-DP (DPV0) PROFIBUS-DP extensions (DPV1 Class 1 and 2 supported)
Support	Device specific: 0x3402
PROFIBUS unit type	PROFIBUS DPV1 Slave
PROFIBUS media type	RS485 (EIA-485), galvanically isolated
PROFIBUS bus connection	Wiring terminals A1/B1 (in) and A2/B2 (out)
PROFIBUS slot / index	PROFIBUS commands must include length (in bytes) as well as slot / index. This is so that multiple values from the same slot (except strings) can be read / written in a single transaction (up to the maximum of 240 bytes). The length must be a multiple of the 'Bytes value for the required slot. The index specifies the starting index for the values returned. The starting index plus the number of bytes must not go beyond the end of the table. Strings must also specify the correct length in bytes but only single strings can be accessed in one transaction.
Bus address range	1 to 126 via local display interface 1 to 125 via Set_Slave_Addr service
Baud rates supported	9.6 kbps 500 kbps 19.2 kbps 1.5 Mbps 45.45 kbps 3 Mbps 93.75 kbps 6 Mbps 187.5 kbps 12 Mbps
Master Class 1 – Slave cyclic services (MS0)	Set_Prm Get_Diag Chk_Cfg Get_Cfg Set_Slave_Addr Rd_Inp Data_Exchange Rd_Outp
Master Class 1 – Slave acyclic services (MS1)	MS1_Read MS1_Write
Device-specific GSD file	ABB_3402.gsd
Configuration support	Local display interface

Table 4.7: PROFIBUS datasheet

4.8 Declaration of PROFIBUS conformance

Navigator 500 is the PNO registered model name for PROFIBUS-enabled Navigator AWT540 transmitters (RS485 physical layer) approved by an independent authorized certification laboratory for connection and use in PROFIBUS networks.

Certification of PROFIBUS specification conformance covers the following areas:

- RS485 bus interface electrical characteristics.
- DPV0 and DPV1 protocol services.
- Navigator AWT540-DP device-specific GSD file (ABB_3402.gsd).

A copy of the conformance certificate is available for download from the Navigator AWT540 product pages of the ABB website www.abb.com.

5 Modbus communications



IMPORTANT (NOTE)

Modbus menus are enabled only if a Modbus communications module is fitted.

This section describes the connection of serial data cables between the master (host computer) and slave (Navigator AWT540 transmitter) on a Modbus serial link.

Menu	Comment	Default
MODBUS		
Device Address	Set a device-specific address (from 1 to 247) to identify the transmitter on a Modbus link.	
RS485 Setup		
Mode	Select the Modbus serial communication serial link type: <i>2 Wire, 4 Wire</i> or <i>Off</i>	4 Wire
Baud Rate	Select a communication transfer rate: <i>1200, 2400, 4800, 9600, 19200, 38400</i> or <i>115200</i> baud.	19200
Parity	Select the parity bit (transmission error-checking) condition: <i>No Parity, Odd Parity</i> or <i>Even Parity</i>	No Parity
Tx Delay	Set a delay to the response from the transmitter in milliseconds. Maximum delay 100 ms.	50 ms

5.1 Host computer serial communications

The serial interface option module operates using the Modbus Remote Terminal Unit (RTU) Master / Slave protocol. An appropriate RS422 / 485 communications driver must be fitted to the host (master) computer. It is strongly recommended that the interface has galvanic isolation to protect the computer from lightning damage and to increase signal immunity to noise pick-up.



IMPORTANT (NOTE)

The Modbus option provides the following facilities:

- Standard RS422/485 communications.
- Modbus RTU protocol – the transmitter is designed to operate as a Remote Terminal Unit (RTU) slave when communicating with a master (host) system.
- 500V DC isolation from external connections to the instrument.
- Two- or four-wire communication (selected at the *RS485 Setup / Mode* parameter).
- 1200, 2400, 4800, 9600, 19200, 38400, or 115200 baud transmission rate.
- Parity-checking (odd, even or none).



WARNING – Bodily injury

Refer to the Navigator AWT540 Commissioning instruction (CI/AWT540-EN) before making electrical connections.

5.2 Two-wire and four-wire connection

Modbus serial communications can be configured as either 2-wire or 4-wire serial links – see Fig. 5.1. The transmitter must be added to the link configuration on the host system – refer to information supplied with the host system.

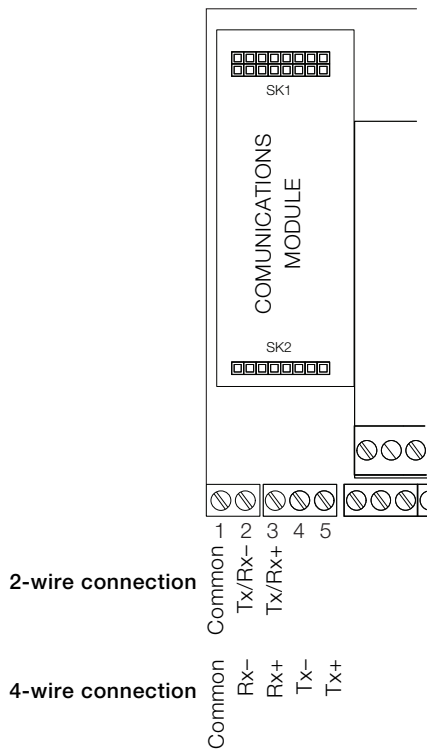

Fig. 5.1: 2-wire and 4-wire Modbus serial links

5.3 Pull-up and pull-down resistors

To prevent false triggering of slaves when the master (host computer) is inactive, fit pull-up and pull-down resistors to the RS422/485 interface in the host computer.

Resistors are normally connected to the interface by hard-wired links or switches – refer to the manufacturer's instructions

5.4 Termination resistor

For long transmission lines, fit 120 Ω termination resistors to the last slave in the chain and the master receiver – see Fig. 5.2.

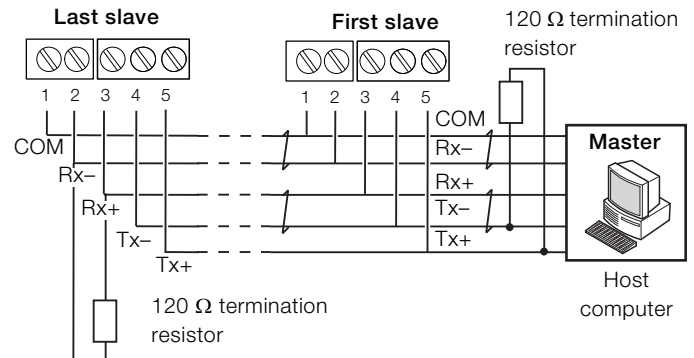

Fig. 5.2: Connecting multiple slaves

5.5 Serial connections

Make connections to the Modbus serial board as shown in Fig. 5.1. On systems with multiple slaves, make connections to two- or four-wire link configurations in parallel as shown in Fig. 5.2. When connecting cable screens, ensure that ground loops are not introduced.

The maximum serial data transmission line length for both RS422 and RS485 systems is 1200 m (3937 ft.).

The types of cable that can be used are determined by the total line length:

- Up to 6 m (19.7 ft.) – standard screened or twisted pair cable.
- Up to 300 m (984 ft.) – twin twisted pair with overall foil screen and an integral drain wire.
- Up to 1200 m (3937 ft.) – twin twisted pair with separate foil screens and integral drain wires.

6 Ethernet communications

Ethernet and email menus are enabled only if an Ethernet communications module is fitted.

Menu	Comment	Default
Ethernet		
DHCP	Select to enable or disable DHCP (Dynamic Host Control Protocol). <i>Enabled</i> – select if the IP address is to be allocated dynamically by the network. <i>Disabled</i> – select if the IP address is defined statically.	Enabled
IP Address *	Enter an IP address assigned to the transmitter. The IP address is used by the TCP/IP protocol to distinguish between different devices. The address is a 32-bit value expressed with 4 values (0 to 255), each separated by a period (.)	000.000. 000.000
* Displayed only if DHCP is set to <i>Disabled</i>		
Subnet Mask	Enter a subnet mask to indicate which part of the IP address is used for the network ID and which part is used for the host ID. Set each bit that is part of the network ID as '1's, for example: 255.255.255.0 indicates the first 24 bits are for the network ID.	Class Default
Default Gateway	Enter the IP address for the Default Gateway (router or switch) used to communicate with other networks. Note. This setting is required only if a router (or switch) is used.	000.000. 000.000
Email		
SMTP Server ID	Enter the IP address of the SMTP (Simple Mail Transport Protocol) server used to distribute emails.	000.000. 000.000
Recipients		
Email Address 1 (to 3)	Enter the email address(es) of the recipient(s).	
Triggers		
Tag 1 (to 4)	Enter an alphanumeric tag (16 characters maximum) that appears in the subject title to identify the trigger.	
Source 1 (to 4)	Select to enable up to 4 independently-configurable triggers to generate an email when the selected source becomes active (the email can be sent to up to 3 recipients).	
Invert 1 (to 4)	If enabled, an email is generated when the <i>Source</i> becomes inactive instead of active.	

6.1 Ethernet connection

Referring to Fig. 6.1:

1. Isolate the transmitter from the power supply.
2. Using a suitable screwdriver, release transmitter door retaining screw (A) and open the door.
3. Unscrew terminal cover screw (B) and remove terminal cover.
4. Route ethernet cable through a suitable cable entry hole (C).

i IMPORTANT (NOTE) Fit cable gland to ethernet cable to maintain IP rating, as required.

5. Connect ethernet cable plug to socket on ethernet board (D).
6. Refit terminal cover and secure with screw (B).
7. Close transmitter door and secure with door retaining screw (A).
8. Restore the transmitter's power supply.

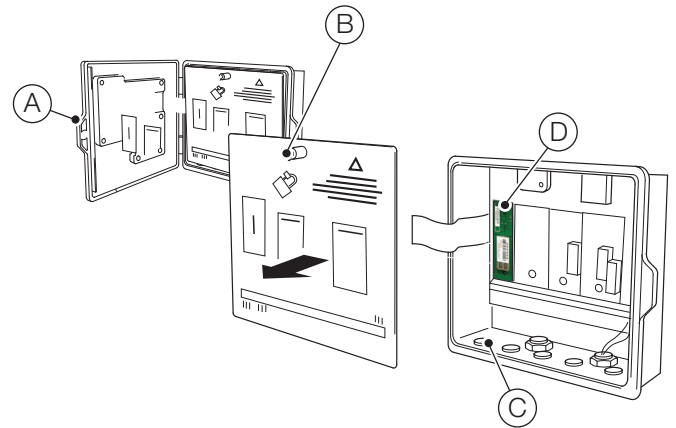

Fig. 6.1: Ethernet connection

Appendix A – PROFIBUS tables

A.1 Module definitions in GSD file for cyclic read

Module 1	Sensor 1 PV (4-bytes float)	Sensor 1 SV (4-bytes float)						
Module 2	Sensor 1 PV (4-bytes float)	Sensor 1 SV (4-bytes float)	Sensor 2 PV (4-bytes float)	Sensor 2 SV (4-bytes float)				
Module 3	Sensor 1 PV (4-bytes float)	Sensor 1 SV (4-bytes float)	Sensor 2 PV (4-bytes float)	Sensor 2 SV (4-bytes float)	Sensor 3 PV (4-bytes float)	Sensor 3 SV (4-bytes float)		
Module 4	Sensor 1 PV (4-bytes float)	Sensor 1 SV (4-bytes float)	Sensor 2 PV (4-bytes float)	Sensor 2 SV (4-bytes float)	Sensor 3 PV (4-bytes float)	Sensor 3 SV (4-bytes float)	Sensor 4 PV (4-bytes float)	Sensor 4 SV (4-bytes float)

A.1.1 Slot 1 – digital inputs

Description	Slot	Index	Object type	Data type	Bytes	Store	Access	Default	Valid range
Sensor 1 concentration value status	1	0	Simple	Unsigned 8	1	D	R	Inactive	0 – Inactive 1 – Active
Sensor 1 temperature value status	1	1	Simple	Unsigned 8	1	D	R	Inactive	
Sensor 2 concentration value status	1	2	Simple	Unsigned 8	1	D	R	Inactive	
Sensor 2 temperature value status	1	3	Simple	Unsigned 8	1	D	R	Inactive	
Sensor 3 concentration value status	1	4	Simple	Unsigned 8	1	D	R	Inactive	
Sensor 3 temperature value status	1	5	Simple	Unsigned 8	1	D	R	Inactive	
Sensor 4 concentration value status	1	6	Simple	Unsigned 8	1	D	R	Inactive	
Sensor 4 temperature value status	1	7	Simple	Unsigned 8	1	D	R	Inactive	
Transmitter failure diagnostic	1	8	Simple	Unsigned 8	1	D	R	Inactive	
Transmitter out of specification diagnostic	1	9	Simple	Unsigned 8	1	D	R	Inactive	
Transmitter maintenance diagnostic	1	10	Simple	Unsigned 8	1	D	R	Inactive	
Transmitter function check diagnostic	1	11	Simple	Unsigned 8	1	D	R	Inactive	
Sensor 1 failure diagnostic	1	12	Simple	Unsigned 8	1	D	R	Inactive	
Sensor 1 out of specification diagnostic	1	13	Simple	Unsigned 8	1	D	R	Inactive	
Sensor 1 maintenance diagnostic	1	14	Simple	Unsigned 8	1	D	R	Inactive	
Sensor 1 function check diagnostic	1	15	Simple	Unsigned 8	1	D	R	Inactive	
Sensor 2 failure diagnostic	1	16	Simple	Unsigned 8	1	D	R	Inactive	
Sensor 2 out of specification diagnostic	1	17	Simple	Unsigned 8	1	D	R	Inactive	
Sensor 2 maintenance diagnostic	1	18	Simple	Unsigned 8	1	D	R	Inactive	
Sensor 2 function check diagnostic	1	19	Simple	Unsigned 8	1	D	R	Inactive	
Sensor 3 failure diagnostic	1	20	Simple	Unsigned 8	1	D	R	Inactive	
Sensor 3 out of specification diagnostic	1	21	Simple	Unsigned 8	1	D	R	Inactive	
Sensor 3 maintenance diagnostic	1	22	Simple	Unsigned 8	1	D	R	Inactive	
Sensor 3 function check diagnostic	1	23	Simple	Unsigned 8	1	D	R	Inactive	
Sensor 4 failure diagnostic	1	24	Simple	Unsigned 8	1	D	R	Inactive	
Sensor 4 out of specification diagnostic	1	25	Simple	Unsigned 8	1	D	R	Inactive	
Sensor 4 maintenance diagnostic	1	26	Simple	Unsigned 8	1	D	R	Inactive	
Sensor 4 function check diagnostic	1	27	Simple	Unsigned 8	1	D	R	Inactive	

A.1.2 Slot 1 – transmitter diagnostics

Description	Slot	Index	Object type	Data type	Bytes	Store	Access	Default	Valid range
NV Error Proc Bd	1	28	Simple	Unsigned 8	1	D	R	Inactive	0 – Inactive 1 – Active
NV Error Main Bd	1	29	Simple	Unsigned 8	1	D	R	Inactive	
NV Error Comm Bd	1	30	Simple	Unsigned 8	1	D	R	Inactive	
NV Error SW Key1	1	31	Simple	Unsigned 8	1	D	R	Inactive	
Int. Comms error	1	32	Simple	Unsigned 8	1	D	R	Inactive	
Excessive power	1	33	Simple	Unsigned 8	1	D	R	Inactive	
Config. error	1	34	Simple	Unsigned 8	1	D	R	Inactive	
Simulation on	1	35	Simple	Unsigned 8	1	D	R	Inactive	
In manual test	1	36	Simple	Unsigned 8	1	D	R	Inactive	
In configuration	1	37	Simple	Unsigned 8	1	D	R	Inactive	
Media card full	1	38	Simple	Unsigned 8	1	D	R	Inactive	
Media near full	1	39	Simple	Unsigned 8	1	D	R	Inactive	

A.1.3 Slot 1 – sensor 1/stream 1 diagnostics

Description	Slot	Index	Object type	Data type	Bytes	Store	Access	Default	Valid range
Temperature sensor failure	1	40	Simple	Unsigned 8	1	D	R	Inactive	0 – Inactive 1 – Active
ADC failure	1	41	Simple	Unsigned 8	1	D	R	Inactive	
Non_Vol memory error	1	42	Simple	Unsigned 8	1	D	R	Inactive	
No sample	1	43	Simple	Unsigned 8	1	D	R	Inactive	
Calibration in progress	1	44	Simple	Unsigned 8	1	D	R	Inactive	
Recovery in progress	1	45	Simple	Unsigned 8	1	D	R	Inactive	
Regeneration in progress	1	46	Simple	Unsigned 8	1	D	R	Inactive	
In hold mode	1	47	Simple	Unsigned 8	1	D	R	Inactive	
Last calibration failed	1	48	Simple	Unsigned 8	1	D	R	Inactive	
Missed schedule calibration	1	49	Simple	Unsigned 8	1	D	R	Inactive	
Sample temperature is hot	1	50	Simple	Unsigned 8	1	D	R	Inactive	
Sample temperature is hot	1	51	Simple	Unsigned 8	1	D	R	Inactive	
Concentration value is out of range	1	52	Simple	Unsigned 8	1	D	R	Inactive	
Type error	1	53	Simple	Unsigned 8	1	D	R	Inactive	
No sample	1	54	Simple	Unsigned 8	1	D	R	Inactive	
No low calibration solution	1	55	Simple	Unsigned 8	1	D	R	Inactive	
No high calibration solution	1	56	Simple	Unsigned 8	1	D	R	Inactive	
No regeneration solution	1	57	Simple	Unsigned 8	1	D	R	Inactive	
Flow error	1	58	Simple	Unsigned 8	1	D	R	Inactive	

A.1.4 Slot 1 – sensor 2/stream 2 diagnostics

Description	Slot	Index	Object type	Data type	Bytes	Store	Access	Default	Valid range
Temperature sensor failure	1	59	Simple	Unsigned 8	1	D	R	Inactive	0 – Inactive 1 – Active
ADC failure	1	60	Simple	Unsigned 8	1	D	R	Inactive	
Non_Vol memory error	1	61	Simple	Unsigned 8	1	D	R	Inactive	
No sample	1	62	Simple	Unsigned 8	1	D	R	Inactive	
Calibration in progress	1	63	Simple	Unsigned 8	1	D	R	Inactive	
Recovery in progress	1	64	Simple	Unsigned 8	1	D	R	Inactive	
Regeneration in progress	1	65	Simple	Unsigned 8	1	D	R	Inactive	
In hold mode	1	66	Simple	Unsigned 8	1	D	R	Inactive	
Last calibration failed	1	67	Simple	Unsigned 8	1	D	R	Inactive	
Missed schedule calibration	1	68	Simple	Unsigned 8	1	D	R	Inactive	
Sample temperature is hot	1	69	Simple	Unsigned 8	1	D	R	Inactive	
Sample temperature is hot	1	70	Simple	Unsigned 8	1	D	R	Inactive	
Concentration value is out of range	1	71	Simple	Unsigned 8	1	D	R	Inactive	
Type error	1	72	Simple	Unsigned 8	1	D	R	Inactive	
No sample	1	73	Simple	Unsigned 8	1	D	R	Inactive	
No low calibration solution	1	74	Simple	Unsigned 8	1	D	R	Inactive	
No high calibration solution	1	75	Simple	Unsigned 8	1	D	R	Inactive	
No regeneration solution	1	76	Simple	Unsigned 8	1	D	R	Inactive	
Flow error	1	77	Simple	Unsigned 8	1	D	R	Inactive	

A.1.5 Slot 1 – sensor 3/stream 3 diagnostics

Description	Slot	Index	Object type	Data type	Bytes	Store	Access	Default	Valid range
Temperature sensor failure	1	78	Simple	Unsigned 8	1	D	R	Inactive	0 – Inactive 1 – Active
ADC failure	1	79	Simple	Unsigned 8	1	D	R	Inactive	
Non_Vol memory error	1	80	Simple	Unsigned 8	1	D	R	Inactive	
No sample	1	81	Simple	Unsigned 8	1	D	R	Inactive	
Calibration in progress	1	82	Simple	Unsigned 8	1	D	R	Inactive	
Recovery in progress	1	83	Simple	Unsigned 8	1	D	R	Inactive	
Regeneration in progress	1	84	Simple	Unsigned 8	1	D	R	Inactive	
In hold mode	1	85	Simple	Unsigned 8	1	D	R	Inactive	
Last calibration failed	1	86	Simple	Unsigned 8	1	D	R	Inactive	
Missed schedule calibration	1	87	Simple	Unsigned 8	1	D	R	Inactive	
Sample temperature is hot	1	88	Simple	Unsigned 8	1	D	R	Inactive	
Sample temperature is hot	1	89	Simple	Unsigned 8	1	D	R	Inactive	
Concentration value is out of range	1	90	Simple	Unsigned 8	1	D	R	Inactive	
Type error	1	91	Simple	Unsigned 8	1	D	R	Inactive	
No sample	1	92	Simple	Unsigned 8	1	D	R	Inactive	
No low calibration solution	1	93	Simple	Unsigned 8	1	D	R	Inactive	
No high calibration solution	1	94	Simple	Unsigned 8	1	D	R	Inactive	
No regeneration solution	1	95	Simple	Unsigned 8	1	D	R	Inactive	
Flow error	1	96	Simple	Unsigned 8	1	D	R	Inactive	

A.1.6 Slot 1 – sensor 4/stream 4 diagnostics

Description	Slot	Index	Object type	Data type	Bytes	Store	Access	Default	Valid range
Temperature sensor failure	1	97	Simple	Unsigned 8	1	D	R	Inactive	0 – Inactive 1 – Active
ADC failure	1	98	Simple	Unsigned 8	1	D	R	Inactive	
Non_Vol memory error	1	99	Simple	Unsigned 8	1	D	R	Inactive	
No sample	1	100	Simple	Unsigned 8	1	D	R	Inactive	
Calibration in progress	1	101	Simple	Unsigned 8	1	D	R	Inactive	
Recovery in progress	1	102	Simple	Unsigned 8	1	D	R	Inactive	
Regeneration in progress	1	103	Simple	Unsigned 8	1	D	R	Inactive	
In hold mode	1	104	Simple	Unsigned 8	1	D	R	Inactive	
Last calibration failed	1	105	Simple	Unsigned 8	1	D	R	Inactive	
Missed schedule calibration	1	106	Simple	Unsigned 8	1	D	R	Inactive	
Sample temperature is hot	1	107	Simple	Unsigned 8	1	D	R	Inactive	
Sample temperature is hot	1	108	Simple	Unsigned 8	1	D	R	Inactive	
Concentration value is out of range	1	109	Simple	Unsigned 8	1	D	R	Inactive	
Type error	1	110	Simple	Unsigned 8	1	D	R	Inactive	
No sample	1	111	Simple	Unsigned 8	1	D	R	Inactive	
No low calibration solution	1	112	Simple	Unsigned 8	1	D	R	Inactive	
No high calibration solution	1	113	Simple	Unsigned 8	1	D	R	Inactive	
No regeneration solution	1	114	Simple	Unsigned 8	1	D	R	Inactive	
Flow error	1	115	Simple	Unsigned 8	1	D	R	Inactive	

A.1.7 Slot 1 – multistream sensor diagnostics

Description	Slot	Index	Object type	Data type	Bytes	Store	Access	Default	Valid range
Temperature sensor failure	1	116	Simple	Unsigned 8	1	D	R	Inactive	0 – Inactive 1 – Active
ADC failure	1	117	Simple	Unsigned 8	1	D	R	Inactive	
Non_Vol memory error	1	118	Simple	Unsigned 8	1	D	R	Inactive	0 – Inactive 1 – Active
No sample	1	119	Simple	Unsigned 8	1	D	R	Inactive	
Calibration in progress	1	120	Simple	Unsigned 8	1	D	R	Inactive	
Recovery in progress	1	121	Simple	Unsigned 8	1	D	R	Inactive	
Regeneration in progress	1	122	Simple	Unsigned 8	1	D	R	Inactive	
In hold mode	1	123	Simple	Unsigned 8	1	D	R	Inactive	
Last calibration failed	1	124	Simple	Unsigned 8	1	D	R	Inactive	
Missed schedule calibration	1	125	Simple	Unsigned 8	1	D	R	Inactive	
Sample temperature is hot	1	126	Simple	Unsigned 8	1	D	R	Inactive	
Sample temperature is hot	1	127	Simple	Unsigned 8	1	D	R	Inactive	
Concentration value is out of range	1	128	Simple	Unsigned 8	1	D	R	Inactive	
No sample stream 1	1	129	Simple	Unsigned 8	1	D	R	Inactive	
No sample stream 2	1	130	Simple	Unsigned 8	1	D	R	Inactive	
No sample stream 3	1	131	Simple	Unsigned 8	1	D	R	Inactive	
No low calibration solution	1	132	Simple	Unsigned 8	1	D	R	Inactive	
No high calibration solution	1	133	Simple	Unsigned 8	1	D	R	Inactive	
No regeneration solution	1	134	Simple	Unsigned 8	1	D	R	Inactive	
Flow error stream 1	1	135	Simple	Unsigned 8	1	D	R	Inactive	
Flow error stream 2	1	136	Simple	Unsigned 8	1	D	R	Inactive	
Flow error stream 3	1	137	Simple	Unsigned 8	1	D	R	Inactive	
Relay 1 state	1	138	Simple	Unsigned 8	1	D	R	Deactivated	0 – Deactivated 1 – Activated
Relay 2 state	1	139	Simple	Unsigned 8	1	D	R	Deactivated	
Relay 3 state	1	140	Simple	Unsigned 8	1	D	R	Deactivated	0 – Deactivated 1 – Activated
Relay 4 state	1	141	Simple	Unsigned 8	1	D	R	Deactivated	
Relay 5 state	1	142	Simple	Unsigned 8	1	D	R	Deactivated	0 – Deactivated 1 – Activated
Relay 6 state	1	143	Simple	Unsigned 8	1	D	R	Deactivated	
Alarm 1 state	1	144	Simple	Unsigned 8	1	D	R	Deactivated	0 – Deactivated 1 – Activated
Alarm 2 state	1	145	Simple	Unsigned 8	1	D	R	Deactivated	
Alarm 3 state	1	146	Simple	Unsigned 8	1	D	R	Deactivated	
Alarm 4 state	1	147	Simple	Unsigned 8	1	D	R	Deactivated	
Alarm 5 state	1	148	Simple	Unsigned 8	1	D	R	Deactivated	
Alarm 6 state	1	149	Simple	Unsigned 8	1	D	R	Deactivated	
Alarm 7 state	1	150	Simple	Unsigned 8	1	D	R	Deactivated	
Alarm 8 state	1	151	Simple	Unsigned 8	1	D	R	Deactivated	
Digital output 1 state	1	152	Simple	Unsigned 8	1	D	R	Low	0 – Low 1 – High
Digital output 2 state	1	153	Simple	Unsigned 8	1	D	R	Low	
Digital output 3 state	1	154	Simple	Unsigned 8	1	D	R	Low	0 – Low 1 – High
Digital output 4 state	1	155	Simple	Unsigned 8	1	D	R	Low	
Digital output 5 state	1	156	Simple	Unsigned 8	1	D	R	Low	
Digital output 6 state	1	157	Simple	Unsigned 8	1	D	R	Low	
Digital input 1 state	1	158	Simple	Unsigned 8	1	D	R	Low	
Digital input 2 state	1	159	Simple	Unsigned 8	1	D	R	Low	
Digital input 3 state	1	160	Simple	Unsigned 8	1	D	R	Low	
Digital input 4 state	1	161	Simple	Unsigned 8	1	D	R	Low	
Digital input 5 state	1	162	Simple	Unsigned 8	1	D	R	Low	
Digital input 6 state	1	163	Simple	Unsigned 8	1	D	R	Low	

A.1.8 Slot 1 – relay status

Description	Slot	Index	Object type	Data type	Bytes	Store	Access	Default	Valid range
Relay 1 state	1	138	Simple	Unsigned 8	1	D	R	Deactivated	0 – Deactivated 1 – Activated
Relay 2 state	1	139	Simple	Unsigned 8	1	D	R	Deactivated	
Relay 3 state	1	140	Simple	Unsigned 8	1	D	R	Deactivated	0 – Deactivated 1 – Activated
Relay 4 state	1	141	Simple	Unsigned 8	1	D	R	Deactivated	
Relay 5 state	1	142	Simple	Unsigned 8	1	D	R	Deactivated	0 – Deactivated 1 – Activated
Relay 6 state	1	143	Simple	Unsigned 8	1	D	R	Deactivated	

A.1.9 Slot 1 – alarm status

Description	Slot	Index	Object type	Data type	Bytes	Store	Access	Default	Valid range
Alarm 1 state	1	144	Simple	Unsigned 8	1	D	R	Deactivated	0 – Deactivated 1 – Activated
Alarm 2 state	1	145	Simple	Unsigned 8	1	D	R	Deactivated	
Alarm 3 state	1	146	Simple	Unsigned 8	1	D	R	Deactivated	
Alarm 4 state	1	147	Simple	Unsigned 8	1	D	R	Deactivated	
Alarm 5 state	1	148	Simple	Unsigned 8	1	D	R	Deactivated	
Alarm 6 state	1	149	Simple	Unsigned 8	1	D	R	Deactivated	
Alarm 7 state	1	150	Simple	Unsigned 8	1	D	R	Deactivated	
Alarm 8 state	1	151	Simple	Unsigned 8	1	D	R	Deactivated	

A.1.10 Slot 1 – digital I/O status

Description	Slot	Index	Object type	Data type	Bytes	Store	Access	Default	Valid range
Digital output 1 state	1	152	Simple	Unsigned 8	1	D	R	Low	0 – Low 1 – High
Digital output 2 state	1	153	Simple	Unsigned 8	1	D	R	Low	
Digital output 3 state	1	154	Simple	Unsigned 8	1	D	R	Low	0 – Low 1 – High
Digital output 4 state	1	155	Simple	Unsigned 8	1	D	R	Low	
Digital output 5 state	1	156	Simple	Unsigned 8	1	D	R	Low	
Digital output 6 state	1	157	Simple	Unsigned 8	1	D	R	Low	
Digital input 1 state	1	158	Simple	Unsigned 8	1	D	R	Low	
Digital input 2 state	1	159	Simple	Unsigned 8	1	D	R	Low	
Digital input 3 state	1	160	Simple	Unsigned 8	1	D	R	Low	
Digital input 4 state	1	161	Simple	Unsigned 8	1	D	R	Low	
Digital input 5 state	1	162	Simple	Unsigned 8	1	D	R	Low	
Digital input 6 state	1	163	Simple	Unsigned 8	1	D	R	Low	

A.2 Alarm acknowledge

A.2.1 Slot 2 – alarm acknowledge

Description	Slot	Index	Object type	Data type	Bytes	Store	Access	Default	Valid range
Alarm acknowledge state 1	2	0	Simple	Unsigned 8	1	D	R/W	Unacknowledged	0 – Unacknowledged 1 – Acknowledged
Alarm acknowledge state 2	2	1	Simple	Unsigned 8	1	D	R/W	Unacknowledged	
Alarm acknowledge state 3	2	2	Simple	Unsigned 8	1	D	R/W	Unacknowledged	
Alarm acknowledge state 4	2	3	Simple	Unsigned 8	1	D	R/W	Unacknowledged	
Alarm acknowledge state 5	2	4	Simple	Unsigned 8	1	D	R/W	Unacknowledged	
Alarm acknowledge state 6	2	5	Simple	Unsigned 8	1	D	R/W	Unacknowledged	
Alarm acknowledge state 7	2	6	Simple	Unsigned 8	1	D	R/W	Unacknowledged	
Alarm acknowledge state 8	2	7	Simple	Unsigned 8	1	D	R/W	Unacknowledged	
Acknowledge alarm 1	2	8	Simple	Unsigned 8	1	D	R/W	Unacknowledged	
Acknowledge alarm 2	2	9	Simple	Unsigned 8	1	D	R/W	Unacknowledged	
Acknowledge alarm 3	2	10	Simple	Unsigned 8	1	D	R/W	Unacknowledged	
Acknowledge alarm 4	2	11	Simple	Unsigned 8	1	D	R/W	Unacknowledged	
Acknowledge alarm 5	2	12	Simple	Unsigned 8	1	D	R/W	Unacknowledged	
Acknowledge alarm 6	2	13	Simple	Unsigned 8	1	D	R/W	Unacknowledged	
Acknowledge alarm 7	2	14	Simple	Unsigned 8	1	D	R/W	Unacknowledged	
Acknowledge alarm 8	2	15	Simple	Unsigned 8	1	D	R/W	Unacknowledged	

A.3 Action commands

A.3.1 Slot 3 – action commands

Description	Slot	Index	Object type	Data type	Bytes	Store	Access	Default	Valid range	Notes
Start zero calibration sensor 1	3	0	Simple	Unsigned 8	1	D	W	0	0 to 255	Writing any value starts the procedure
Start span calibration sensor 1	3	1	Simple	Unsigned 8	1	D	W	0	0 to 255	
Start two point calibration sensor 1	3	2	Simple	Unsigned 8	1	D	W	0	0 to 255	
Start regeneration sensor 1	3	3	Simple	Unsigned 8	1	D	W	0	0 to 255	
Start zero calibration sensor 2	3	4	Simple	Unsigned 8	1	D	W	0	0 to 255	
Start span calibration sensor 2	3	5	Simple	Unsigned 8	1	D	W	0	0 to 255	
Start two point calibration sensor 2	3	6	Simple	Unsigned 8	1	D	W	0	0 to 255	
Start regeneration sensor 2	3	7	Simple	Unsigned 8	1	D	W	0	0 to 255	
Start zero calibration sensor 3	3	8	Simple	Unsigned 8	1	D	W	0	0 to 255	
Start span calibration sensor 3	3	9	Simple	Unsigned 8	1	D	W	0	0 to 255	
Start two point calibration sensor 3	3	10	Simple	Unsigned 8	1	D	W	0	0 to 255	
Start regeneration sensor 3	3	11	Simple	Unsigned 8	1	D	W	0	0 to 255	
Start zero calibration sensor 4	3	12	Simple	Unsigned 8	1	D	W	0	0 to 255	
Start span calibration sensor 4	3	13	Simple	Unsigned 8	1	D	W	0	0 to 255	
Start two point calibration sensor 4	3	14	Simple	Unsigned 8	1	D	W	0	0 to 255	
Start regeneration sensor 4	3	15	Simple	Unsigned 8	1	D	W	0	0 to 255	

A.4 Read-only, float

A.4.1 Slot 4 – measured values

Description	Slot	Index	Object type	Data type	Bytes	Store	Access	Notes
Sensor 1 – Concentration	4	0	Simple	Float	4	D	R	See engineering ranges
Sensor 1 – Temperature	4	1	Simple	Float	4	D	R	
Sensor 2 – Concentration	4	2	Simple	Float	4	D	R	
Sensor 2 – Temperature	4	3	Simple	Float	4	D	R	
Sensor 3 – Concentration	4	4	Simple	Float	4	D	R	
Sensor 3 – Temperature	4	5	Simple	Float	4	D	R	
Sensor 4 – Concentration	4	6	Simple	Float	4	D	R	
Sensor 4 – Temperature	4	7	Simple	Float	4	D	R	
Sensor 1 – Concentration	4	8	Simple	Float	4	D	R	Single-stream – sensor 1
Sensor 1 – Temperature	4	9	Simple	Float	4	D	R	
Sensor 1 – Raw signal	4	10	Simple	Float	4	D	R	
Sensor 1 – Flow rate	4	11	Simple	Float	4	D	R	
Sensor 1 – Active calibration slope	4	12	Simple	Float	4	D	R	
Sensor 1 – Active calibration offset	4	13	Simple	Float	4	D	R	
Sensor 1 – Last calibration slope	4	14	Simple	Float	4	D	R	
Sensor 1 – Last calibration offset	4	15	Simple	Float	4	D	R	
Sensor 2 – Concentration	4	16	Simple	Float	4	D	R	Single-stream – sensor 2
Sensor 2 – Temperature	4	17	Simple	Float	4	D	R	
Sensor 2 – Raw signal	4	18	Simple	Float	4	D	R	
Sensor 2 – Flow rate	4	19	Simple	Float	4	D	R	
Sensor 2 – Active calibration slope	4	20	Simple	Float	4	D	R	
Sensor 2 – Active calibration offset	4	21	Simple	Float	4	D	R	
Sensor 2 – Last calibration slope	4	22	Simple	Float	4	D	R	
Sensor 2 – Last calibration offset	4	23	Simple	Float	4	D	R	
Sensor 3 – Concentration	4	24	Simple	Float	4	D	R	Single-stream – sensor 3
Sensor 3 – Temperature	4	25	Simple	Float	4	D	R	
Sensor 3 – Raw signal	4	26	Simple	Float	4	D	R	
Sensor 3 – Flow rate	4	27	Simple	Float	4	D	R	
Sensor 3 – Active calibration slope	4	28	Simple	Float	4	D	R	
Sensor 3 – Active calibration offset	4	29	Simple	Float	4	D	R	
Sensor 3 – Last calibration slope	4	30	Simple	Float	4	D	R	
Sensor 3 – Last calibration offset	4	31	Simple	Float	4	D	R	
Sensor 4 – Concentration	4	32	Simple	Float	4	D	R	Single-stream – sensor 4
Sensor 4 – Temperature	4	33	Simple	Float	4	D	R	
Sensor 4 – Raw signal	4	34	Simple	Float	4	D	R	
Sensor 4 – Flow rate	4	35	Simple	Float	4	D	R	
Sensor 4 – Active calibration slope	4	36	Simple	Float	4	D	R	
Sensor 4 – Active calibration offset	4	37	Simple	Float	4	D	R	
Sensor 4 – Last calibration slope	4	38	Simple	Float	4	D	R	
Sensor 4 – Last calibration offset	4	39	Simple	Float	4	D	R	
Stream 1 – Concentration	4	40	Simple	Float	4	D	R	Two-stream
Stream 1 – Temperature	4	41	Simple	Float	4	D	R	
Stream 2 – Concentration	4	42	Simple	Float	4	D	R	
Stream 2 – Temperature	4	43	Simple	Float	4	D	R	
Raw signal	4	44	Simple	Float	4	D	R	
Stream 1 – Flow rate	4	45	Simple	Float	4	D	R	
Stream 2 – Flow rate	4	46	Simple	Float	4	D	R	
Active calibration slope	4	47	Simple	Float	4	D	R	
Active calibration offset	4	48	Simple	Float	4	D	R	
Last calibration slope	4	49	Simple	Float	4	D	R	
Last calibration offset	4	50	Simple	Float	4	D	R	

Description	Slot	Index	Object type	Data type	Bytes	Store	Access	Notes
Stream 1 – Concentration	4	51	Simple	Float	4	D	R	Three-stream
Stream 1 – Temperature	4	52	Simple	Float	4	D	R	
Stream 2 – Concentration	4	53	Simple	Float	4	D	R	
Stream 2 – Temperature	4	54	Simple	Float	4	D	R	
Stream 3 – Concentration	4	55	Simple	Float	4	D	R	
Stream 3 – Temperature	4	56	Simple	Float	4	D	R	
Raw signal	4	57	Simple	Float	4	D	R	
Stream 1 – Flow rate	4	58	Simple	Float	4	D	R	
Stream 2 – Flow rate	4	59	Simple	Float	4	D	R	
Stream 3 – Flow rate	4	60	Simple	Float	4	D	R	
Active calibration slope	4	61	Simple	Float	4	D	R	
Active calibration offset	4	62	Simple	Float	4	D	R	
Last calibration slope	4	63	Simple	Float	4	D	R	
Last calibration offset	4	64	Simple	Float	4	D	R	

A.4.2 Slot 4 – range limits

Description	Slot	Index	Object type	Data type	Bytes	Store	Access	Notes
Sensor 1 – Concentration range high	4	65	Simple	Float	4	C	R	See engineering ranges
Sensor 1 – Concentration range low	4	66	Simple	Float	4	C	R	
Sensor 2 – Concentration range high	4	67	Simple	Float	4	C	R	
Sensor 2 – Concentration range low	4	68	Simple	Float	4	C	R	
Sensor 3 – Concentration range high	4	69	Simple	Float	4	C	R	
Sensor 3 – Concentration range low	4	70	Simple	Float	4	C	R	
Sensor 4 – Concentration range high	4	71	Simple	Float	4	C	R	
Sensor 4 – Concentration range low	4	72	Simple	Float	4	C	R	
Sensor 1 – Temperature range high	4	73	Simple	Float	4	C	R	
Sensor 1 – Temperature range low	4	74	Simple	Float	4	C	R	
Sensor 2 – Temperature range high	4	75	Simple	Float	4	C	R	
Sensor 2 – Temperature range low	4	76	Simple	Float	4	C	R	
Sensor 3 – Temperature range high	4	77	Simple	Float	4	C	R	
Sensor 3 – Temperature range low	4	78	Simple	Float	4	C	R	
Sensor 4 – Temperature range high	4	79	Simple	Float	4	C	R	
Sensor 4 – Temperature range low	4	80	Simple	Float	4	C	R	

A.4.3 Slot 4 – analog O/P values

Description	Slot	Index	Object type	Data type	Bytes	Store	Access	Notes
Analog output 1 – mA value	4	81	Simple	Float	4	D	R	
Analog output 2 – mA value	4	82	Simple	Float	4	D	R	
Analog output 3 – mA value	4	83	Simple	Float	4	D	R	
Analog output 4 – mA value	4	84	Simple	Float	4	D	R	
Analog output 1 – % of range	4	85	Simple	Float	4	D	R	
Analog output 2 – % of range	4	86	Simple	Float	4	D	R	
Analog output 3 – % of range	4	87	Simple	Float	4	D	R	
Analog output 4 – % of range	4	88	Simple	Float	4	D	R	

A.5

A.5.1 Slot 5 – device info

Description	Slot	Index	Object type	Data type	Bytes	Store	Access	Notes
Transmitter – Date of manufacture	5	0	Simple	Unsigned 32	4	D	R	Number of seconds since January 1 st 2000
Sensor 1 – Date of manufacture	5	1	Simple	Unsigned 32	4	D	R	
Sensor 2 – Date of manufacture	5	2	Simple	Unsigned 32	4	D	R	
Sensor 3 – Date of manufacture	5	3	Simple	Unsigned 32	4	D	R	
Sensor 4 – Date of manufacture	5	4	Simple	Unsigned 32	4	D	R	
Sensor 1 – Next calibration time	5	5	Simple	Unsigned 32	4	D	R	
Sensor 2 – Next calibration time	5	6	Simple	Unsigned 32	4	D	R	
Sensor 3 – Next calibration time	5	7	Simple	Unsigned 32	4	D	R	
Sensor 4 – Next calibration time	5	8	Simple	Unsigned 32	4	D	R	
Stream 1 – Update time	5	9	Simple	Unsigned 32	4	D	R	
Stream 2 – Update time	5	10	Simple	Unsigned 32	4	D	R	
Stream 3 – Update time	5	11	Simple	Unsigned 32	4	D	R	

A.6

A.6.1 Slot 6 – device info

Description	Slot	Index	Object type	Data type	Bytes	Store	Access	Default	Valid range
Sensor 1 – Hardware version number	6	0	Simple	Unsigned 16	2	D	R	Current hardware version	1 to 9
Sensor 2 – Hardware version number	6	1	Simple	Unsigned 16	2	D	R		
Sensor 2 – Hardware version number	6	2	Simple	Unsigned 16	2	D	R		
Sensor 2 – Hardware version number	6	3	Simple	Unsigned 16	2	D	R		

A.7

A.7.1 Slot 7 – sensor type and hardware options

Description	Slot	Index	Object type	Data type	Bytes	Store	Access	Default	Valid range
Sensor 1 – Type	7	0	Simple	Unsigned 8	1	D	R		0 – Unrecognized 12 – Sodium 13 – Sodium two-stream 14 – Sodium three-stream 15 – Low level dissolved oxygen 16 – Hydrazine 255 – No sensor fitted
Sensor 1 – Flow sensor fitted	7	1	Simple	Unsigned 8	1	D	R		0 – Disabled 1 – Enabled
Sensor 1 – Regeneration hardware fitted	7	2	Simple	Unsigned 8	1	D	R		0 – Disabled 1 – Enabled
Sensor 2 – Type	7	3	Simple	Unsigned 8	1	D	R		0 – Unrecognized 12 – Sodium 13 – Sodium two-stream 14 – Sodium three-stream 15 – Low level dissolved oxygen 16 – Hydrazine 255 – No sensor fitted
Sensor 2 – Flow sensor fitted	7	4	Simple	Unsigned 8	1	D	R		0 – Disabled 1 – Enabled
Sensor 2 – Regeneration hardware fitted	7	5	Simple	Unsigned 8	1	D	R		0 – Disabled 1 – Enabled
Sensor 3 – Type	7	6	Simple	Unsigned 8	1	D	R		0 – Unrecognized 12 – Sodium 13 – Sodium two-stream 14 – Sodium three-stream 15 – Low level dissolved oxygen 16 – Hydrazine 255 – No sensor fitted
Sensor 3 – Flow sensor fitted	7	7	Simple	Unsigned 8	1	D	R		0 – Disabled 1 – Enabled
Sensor 3 – Regeneration hardware fitted	7	8	Simple	Unsigned 8	1	D	R		0 – Disabled 1 – Enabled
Sensor 4 – Type	7	9	Simple	Unsigned 8	1	D	R		0 – Unrecognized 12 – Sodium 13 – Sodium two-stream 14 – Sodium three-stream 15 – Low level dissolved oxygen 16 – Hydrazine 255 – No sensor fitted
Sensor 4 – Flow sensor fitted	7	10	Simple	Unsigned 8	1	D	R		0 – Disabled 1 – Enabled
Sensor 4 – Regeneration hardware fitted	7	11	Simple	Unsigned 8	1	D	R		0 – Disabled 1 – Enabled
Media card hardware version number	7	12	Simple	Unsigned 8	1	D	R	Current hardware version	1 to 9

A.8

A.8.1 Slot 8 – device info

Description	Slot	Index	Object type	Data type	Bytes	Store	Access	Default	Valid range
Transmitter software revision number	8	0	Simple	Visible string	19	C	R	Current revision	ASCII String
Transmitter serial number	8	1	Simple	Visible string	14	C	R	Device serial number	
Sensor 1 software revision number	8	2	Simple	Visible string	19	C	R	Current revision	
Sensor 1 serial number	8	3	Simple	Visible string	14	C	R	Device serial number	
Sensor 2 software revision number	8	4	Simple	Visible string	19	C	R	Current revision	
Sensor 2 serial number	8	5	Simple	Visible string	14	C	R	Device serial number	
Sensor 3 software revision number	8	6	Simple	Visible string	19	C	R	Current revision	
Sensor 3 serial number	8	7	Simple	Visible string	14	C	R	Device serial number	
Sensor 4 software revision number	8	8	Simple	Visible string	19	C	R	Current revision	
Sensor 4 serial number	8	9	Simple	Visible string	14	C	R	Device serial number	
Media card software version number	8	10	Simple	Visible string	19	C	R	Current revision	

A.9 Not used

A.10

A.10.1 Slot 10 – device configuration

Description	Slot	Index	Object type	Data type	Bytes	Store	Access	Default	Valid range	Notes
Chart – Trace 1 – Range high	10	0	Simple	Float	4	D	R/W		Engineering low to engineering high	See engineering ranges
Chart – Trace 1 – Range low	10	1	Simple	Float	4	D	R/W			
Chart – Trace 2 – Range high	10	2	Simple	Float	4	D	R/W			
Chart – Trace 2 – Range low	10	3	Simple	Float	4	D	R/W			
Chart – Trace 3 – Range high	10	4	Simple	Float	4	D	R/W			
Chart – Trace 3 – Range low	10	5	Simple	Float	4	D	R/W			
Chart – Trace 4 – Range high	10	6	Simple	Float	4	D	R/W			
Chart – Trace 4 – Range low	10	7	Simple	Float	4	D	R/W			

A.10.2 Slot 10 – alarm settings

Description	Slot	Index	Object type	Data type	Bytes	Store	Access	Default	Valid range	Notes
Alarm 1 – Trip point	10	8	Simple	Float	4	D	R/W		Engineering low to engineering high	See engineering ranges
Alarm 2 – Trip point	10	9	Simple	Float	4	D	R/W			
Alarm 3 – Trip point	10	10	Simple	Float	4	D	R/W			
Alarm 4 – Trip point	10	11	Simple	Float	4	D	R/W			
Alarm 5 – Trip point	10	12	Simple	Float	4	D	R/W			
Alarm 6 – Trip point	10	13	Simple	Float	4	D	R/W			
Alarm 7 – Trip point	10	14	Simple	Float	4	D	R/W			
Alarm 8 – Trip point	10	15	Simple	Float	4	D	R/W			
Alarm 1 – Hysteresis	10	16	Simple	Float	4	D	R/W			
Alarm 2 – Hysteresis	10	17	Simple	Float	4	D	R/W			
Alarm 3 – Hysteresis	10	18	Simple	Float	4	D	R/W			
Alarm 4 – Hysteresis	10	19	Simple	Float	4	D	R/W			
Alarm 5 – Hysteresis	10	20	Simple	Float	4	D	R/W			
Alarm 6 – Hysteresis	10	21	Simple	Float	4	D	R/W			
Alarm 7 – Hysteresis	10	22	Simple	Float	4	D	R/W			
Alarm 8 – Hysteresis	10	23	Simple	Float	4	D	R/W			

A.10.3 Slot 10 – analog output settings

Description	Slot	Index	Object type	Data type	Bytes	Store	Access	Default	Valid range	Notes
Analog output 1 – Electrical range high	10	24	Simple	Float	4	D	R/W	20 mA	0 to 22 mA	
Analog output 1 – Electrical range low	10	25	Simple	Float	4	D	R/W	4 mA		
Analog output 1 – Engineering range high	10	26	Simple	Float	4	D	R/W		Engineering low to engineering high	See engineering ranges
Analog output 1 – Engineering range low	10	27	Simple	Float	4	D	R/W			
Analog output 2 – Electrical range high	10	28	Simple	Float	4	D	R/W	20 mA	0 to 22 mA	
Analog output 2 – Electrical range low	10	29	Simple	Float	4	D	R/W	4 mA		
Analog output 2 – Engineering range high	10	30	Simple	Float	4	D	R/W		Engineering low to engineering high	See engineering ranges
Analog output 2 – Engineering range low	10	31	Simple	Float	4	D	R/W			
Analog output 3 – Electrical range high	10	32	Simple	Float	4	D	R/W	20 mA	0 to 22 mA	
Analog output 3 – Electrical range low	10	33	Simple	Float	4	D	R/W	4 mA		
Analog output 3 – Engineering range high	10	34	Simple	Float	4	D	R/W		Engineering low to engineering high	See engineering ranges
Analog output 3 – Engineering range low	10	35	Simple	Float	4	D	R/W			
Analog output 4 – Electrical range high	10	36	Simple	Float	4	D	R/W	20 mA	0 to 22 mA	
Analog output 4 – Electrical range low	10	37	Simple	Float	4	D	R/W	4 mA		
Analog output 4 – Engineering range high	10	38	Simple	Float	4	D	R/W		Engineering low to engineering high	See engineering ranges
Analog output 4 – Engineering range low	10	39	Simple	Float	4	D	R/W			

Description	Slot	Index	Object type	Data type	Bytes	Store	Access	Default	Valid range	Notes
Analog output 1 – Failure current	10	40	Simple	Float	4	D	R/W	22 mA	0 to 22 mA	
Analog output 2 – Failure current	10	41	Simple	Float	4	D	R/W	22 mA		
Analog output 3 – Failure current	10	42	Simple	Float	4	D	R/W	22 mA		
Analog output 4 – Failure current	10	43	Simple	Float	4	D	R/W	22 mA		

A.11

A.11.1 Slot 11 – sensor settings

Description	Slot	Index	Object type	Data type	Bytes	Store	Access	Default	Valid range	Notes
Sensor 1 – Recovery time	11	0	Simple	Unsigned 16	2	D	R/W	15	5 to 120 minutes	
Sensor 1 – Salinity correction	11	1	Simple	Unsigned 16	2	D	R/W	0	0 to 80 ppt	Low level dissolved oxygen only
Sensor 1 – Pressure compensation	11	2	Simple	Unsigned 16	2	D	R/W	760	500 to 800 mmHg	
Sensor 1 – Grab sample sampling time	11	3	Simple	Unsigned 16	2	D	R/W	15	10 to 60 minutes	Sodium only
Sensor 2 – Recovery time	11	4	Simple	Unsigned 16	2	D	R/W	15	5 to 120 minutes	
Sensor 2 – Salinity correction	11	5	Simple	Unsigned 16	2	D	R/W	0	0 to 80 ppt	Low level dissolved oxygen only
Sensor 2 – Pressure compensation	11	6	Simple	Unsigned 16	2	D	R/W	760	500 to 800 mmHg	
Sensor 2 – Grab sample sampling time	11	7	Simple	Unsigned 16	2	D	R/W	15	10 to 60 minutes	Sodium only
Sensor 3 – Recovery time	11	8	Simple	Unsigned 16	2	D	R/W	15	5 to 120 minutes	
Sensor 3 – Salinity correction	11	9	Simple	Unsigned 16	2	D	R/W	0	0 to 80 ppt	Low level dissolved oxygen only
Sensor 3 – Pressure compensation	11	10	Simple	Unsigned 16	2	D	R/W	760	500 to 800 mmHg	
Sensor 3 – Grab sample sampling time	11	11	Simple	Unsigned 16	2	D	R/W	15	10 to 60 minutes	Sodium only
Sensor 4 – Recovery time	11	12	Simple	Unsigned 16	2	D	R/W	15	5 to 120 minutes	
Sensor 4 – Salinity correction	11	13	Simple	Unsigned 16	2	D	R/W	0	0 to 80 ppt	Low level dissolved oxygen only
Sensor 4 – Pressure compensation	11	14	Simple	Unsigned 16	2	D	R/W	760	500 to 800 mmHg	
Sensor 4 – Grab sample sampling time	11	15	Simple	Unsigned 16	2	D	R/W	15	10 to 60 minutes	Sodium only
Stream Sample Rate	11	16	Simple	Unsigned 16	2	D	R/W	15	10 to 60 minutes	Sodium multi-stream only

A.11.2 Slot 11 – alarm time and hysteresis

Description	Slot	Index	Object type	Data type	Bytes	Store	Access	Default	Valid range	Notes
Alarm 1 – Time hysteresis	11	17	Simple	Unsigned 16	2	D	R/W	0	0 to 9999 seconds	
Alarm 2 – Time hysteresis	11	18	Simple	Unsigned 16	2	D	R/W	0	0 to 9999 seconds	
Alarm 3 – Time hysteresis	11	19	Simple	Unsigned 16	2	D	R/W	0	0 to 9999 seconds	
Alarm 4 – Time hysteresis	11	20	Simple	Unsigned 16	2	D	R/W	0	0 to 9999 seconds	
Alarm 5 – Time hysteresis	11	21	Simple	Unsigned 16	2	D	R/W	0	0 to 9999 seconds	
Alarm 6 – Time hysteresis	11	22	Simple	Unsigned 16	2	D	R/W	0	0 to 9999 seconds	
Alarm 7 – Time hysteresis	11	23	Simple	Unsigned 16	2	D	R/W	0	0 to 9999 seconds	
Alarm 8 – Time hysteresis	11	24	Simple	Unsigned 16	2	D	R/W	0	0 to 9999 seconds	

A.12

A.12.1 Slot 12 – single stream sensor configuration

Description	Slot	Index	Object type	Data type	Bytes	Store	Access	Default	Valid range	Notes
Transmitter – Temperature units	12	0	Simple	Unsigned 8	1	D	R/W	Deg.C	13 to 14	13 – Deg.C 14 – Deg. F
Sensor 1 – Concentration units	12	1	Simple	Unsigned 8	1	D	R/W	ppb	7 to 9	7 – ppb 8 – ug/l 9 – ug/Kg
Sensor 1 – Filter type	12	2	Simple	Unsigned 8	1	D	R/W	Off	0 to 4	0 – Off 1 – Minimum value 2 – Maximum value 3 – Average value 4 – Sliding average
Sensor 1 – Filter time	12	3	Simple	Unsigned 8	1	D	R/W	5	5 to 100	Samples / seconds
Sensor 1 – Wetting routine procedure	12	4	Simple	Unsigned 8	1	D	R/W	Disabled	0 to 1	0 – Disabled 1 – Enabled
Sensor 1 – Flow measurement	12	5	Simple	Unsigned 8	1	D	R/W	Disabled	0 to 1	0 – Disabled 1 – Enabled
Sensor 1 – Out of sample detection	12	6	Simple	Unsigned 8	1	D	R/W	Disabled	0 to 1	0 – Disabled 1 – Enabled
Sensor 1 – Scheduled Calibration Type	12	7	Simple	Unsigned 8	1	D	R/W	Scheduled calibration disabled	0 to 5	0 – Scheduled calibration disabled 1 – One point calibration (low standard) 2 – One point calibration (high standard) 3 – Two point calibration 4 – Regeneration + two point calibration 5 – One point air calibration
Sensor 1 – Scheduled Calibration Frequency Units	12	8	Simple	Unsigned 8	1	D	R/W	Frequency off	0 to 3	0 – Frequency off 1 – Daily 2 – Weekly 3 – Monthly
Sensor 1 – Scheduled calibration frequency daily	12	9	Simple	Unsigned 8	1	D	R/W	Daily	0 to 6	0 – Daily 1 – Two days 2 – Three days 3 – Four days 4 – Five days 5 – Six days 6 – Seven days
Sensor 1 – Scheduled calibration frequency weekly	12	10	Simple	Unsigned 8	1	D	R/W	Weekly	0 to 7	0 – Weekly 1 – Two weeks 2 – Three weeks 3 – Four weeks 4 – Five weeks 5 – Six weeks 6 – Seven weeks 7 – Eight weeks
Sensor 1 – Scheduled calibration frequency monthly	12	11	Simple	Unsigned 8	1	D	R/W	Monthly	0 to 5	0 – Monthly 1 – Two months 2 – Three months 3 – Four months 4 – Six months 5 – Twelve months

Description	Slot	Index	Object type	Data type	Bytes	Store	Access	Default	Valid range	Notes
Sensor 2 – Concentration units	12	12	Simple	Unsigned 8	1	D	R/W	ppb	7 to 9	7 – ppb 8 – ug/l 9 – ug/Kg
Sensor 2 – Filter type	12	13	Simple	Unsigned 8	1	D	R/W	Off	0 to 4	0 – Off 1 – Minimum value 2 – Maximum value 3 – Average value 4 – Sliding average
Sensor 2 – Filter units	12	14	Simple	Unsigned 8	1	D	R/W	5	5 to 100	Samples / seconds
Sensor 2 – Wetting routine procedure	12	15	Simple	Unsigned 8	1	D	R/W	Disabled	0 to 1	0 – Disabled 1 – Enabled
Sensor 2 – Flow measurement	12	16	Simple	Unsigned 8	1	D	R/W	Disabled	0 to 1	0 – Disabled 1 – Enabled
Sensor 2 – Out of sample detection	12	17	Simple	Unsigned 8	1	D	R/W	Disabled	0 to 1	0 – Disabled 1 – Enabled
Sensor 2 – Scheduled Calibration Type	12	18	Simple	Unsigned 8	1	D	R/W	Scheduled calibration disabled	0 to 5	0 – Scheduled calibration disabled 1 – One point calibration (low standard) 2 – One point calibration (high standard) 3 – Two point calibration 4 – Regeneration + two point calibration 5 – One point air calibration
Sensor 2 – Scheduled calibration frequency units	12	19	Simple	Unsigned 8	1	D	R/W	Frequency off	0 to 3	0 – Frequency off 1 – Daily 2 – Weekly 3 – Monthly
Sensor 2 – Scheduled calibration frequency daily	12	20	Simple	Unsigned 8	1	D	R/W	Daily	0 to 6	0 – Daily 1 – Two days 2 – Three days 3 – Four days 4 – Five days 5 – Six days 6 – Seven days
Sensor 2 – Scheduled calibration frequency weekly	12	21	Simple	Unsigned 8	1	D	R/W	Weekly	0 to 7	0 – Weekly 1 – Two weeks 2 – Three weeks 3 – Four weeks 4 – Five weeks 5 – Six weeks 6 – Seven weeks 7 – Eight weeks
Sensor 2 – Scheduled calibration frequency monthly	12	22	Simple	Unsigned 8	1	D	R/W	Monthly	0 to 5	0 – Monthly 1 – Two months 2 – Three months 3 – Four months 4 – Six months 5 – Twelve months

Description	Slot	Index	Object type	Data type	Bytes	Store	Access	Default	Valid range	Notes
Sensor 3 – Concentration units	12	23	Simple	Unsigned 8	1	D	R/W	ppb	7 to 9	7 – ppb 8 – ug/l 9 – ug/Kg
Sensor 3 – Filter type	12	24	Simple	Unsigned 8	1	D	R/W	Off	0 to 4	0 – Off 1 – Minimum value 2 – Maximum value 3 – Average value 4 – Sliding average
Sensor 3 – Filter units	12	25	Simple	Unsigned 8	1	D	R/W	5	5 to 100	Samples / seconds
Sensor 3 – Wetting routine procedure	12	26	Simple	Unsigned 8	1	D	R/W	Disabled	0 to 1	0 – Disabled 1 – Enabled
Sensor 3 – Flow measurement	12	27	Simple	Unsigned 8	1	D	R/W	Disabled	0 to 1	0 – Disabled 1 – Enabled
Sensor 3 – Out of sample detection	12	28	Simple	Unsigned 8	1	D	R/W	Disabled	0 to 1	0 – Disabled 1 – Enabled
Sensor 3 – Scheduled calibration type	12	29	Simple	Unsigned 8	1	D	R/W	Scheduled calibration disabled	0 to 5	0 – Scheduled calibration disabled 1 – One point calibration (low standard) 2 – One point calibration (high standard) 3 – Two point calibration 4 – Regeneration + two point calibration 5 – One point air calibration
Sensor 3 – Scheduled calibration frequency units	12	30	Simple	Unsigned 8	1	D	R/W	Frequency off	0 to 3	0 – Frequency off 1 – Daily 2 – Weekly 3 – Monthly
Sensor 3 – Scheduled calibration frequency daily	12	31	Simple	Unsigned 8	1	D	R/W	Daily	0 to 6	0 – Daily 1 – Two days 2 – Three days 3 – Four days 4 – Five days 5 – Six days 6 – Seven days
Sensor 3 – Scheduled calibration frequency weekly	12	32	Simple	Unsigned 8	1	D	R/W	Weekly	0 to 7	0 – Weekly 1 – Two weeks 2 – Three weeks 3 – Four weeks 4 – Five weeks 5 – Six weeks 6 – Seven weeks 7 – Eight weeks
Sensor 3 – Scheduled calibration frequency monthly	12	33	Simple	Unsigned 8	1	D	R/W	Monthly	0 to 5	0 – Monthly 1 – Two months 2 – Three months 3 – Four months 4 – Six months 5 – Twelve months

Description	Slot	Index	Object type	Data type	Bytes	Store	Access	Default	Valid range	Notes
Sensor 4 – Concentration units	12	34	Simple	Unsigned 8	1	D	R/W	ppb	7 to 9	7 – ppb 8 – ug/l 9 – ug/Kg
Sensor 4 – Filter type	12	35	Simple	Unsigned 8	1	D	R/W	Off	0 to 4	0 – Off 1 – Minimum value 2 – Maximum value 3 – Average value 4 – Sliding average
Sensor 4 – Filter units	12	36	Simple	Unsigned 8	1	D	R/W	5	5 to 100	Samples / seconds
Sensor 4 – Wetting routine procedure	12	37	Simple	Unsigned 8	1	D	R/W	Disabled	0 to 1	0 – Disabled 1 – Enabled
Sensor 4 – Flow measurement	12	38	Simple	Unsigned 8	1	D	R/W	Disabled	0 to 1	0 – Disabled 1 – Enabled
Sensor 4 – Out of sample detection	12	39	Simple	Unsigned 8	1	D	R/W	Disabled	0 to 1	0 – Disabled 1 – Enabled
Sensor 4 – Scheduled calibration type	12	40	Simple	Unsigned 8	1	D	R/W	Scheduled calibration disabled	0 to 5	0 – Scheduled calibration disabled 1 – One point calibration (low standard) 2 – One point calibration (high standard) 3 – Two point calibration 4 – Regeneration + two point calibration 5 – One point air calibration
Sensor 4 – Scheduled calibration frequency units	12	41	Simple	Unsigned 8	1	D	R/W	Frequency off	0 to 3	0 – Frequency off 1 – Daily 2 – Weekly 3 – Monthly
Sensor 4 – Scheduled calibration frequency daily	12	42	Simple	Unsigned 8	1	D	R/W	Daily	0 to 6	0 – Daily 1 – Two days 2 – Three days 3 – Four days 4 – Five days 5 – Six days 6 – Seven days
Sensor 4 – Scheduled calibration frequency weekly	12	43	Simple	Unsigned 8	1	D	R/W	Weekly	0 to 7	0 – Weekly 1 – Two weeks 2 – Three weeks 3 – Four weeks 4 – Five weeks 5 – Six weeks 6 – Seven weeks 7 – Eight weeks
Sensor 4 – Scheduled calibration frequency monthly	12	44	Simple	Unsigned 8	1	D	R/W	Monthly	0 to 5	0 – Monthly 1 – Two months 2 – Three months 3 – Four months 4 – Six months 5 – Twelve months

A.12.2 Slot 12 – multi stream sensor configuration

Description	Slot	Index	Object type	Data type	Bytes	Store	Access	Default	Valid range	Notes
Transmitter – Temperature units	12	45	Simple	Unsigned 8	1	D	R/W	Deg.C	13 to 14	Multi-stream sodium only
Concentration units	12	46	Simple	Unsigned 8	1	D	R/W	ppb	7 to 9	
Filter type	12	47	Simple	Unsigned 8	1	D	R/W	Off	0 to 4	
Filter units	12	48	Simple	Unsigned 8	1	D	R/W	5	5 to 100	
Wetting routine procedure	12	49	Simple	Unsigned 8	1	D	R/W	Disabled	0 to 1	
Stream 1 – Flow measurement	12	50	Simple	Unsigned 8	1	D	R/W	Disabled	0 to 1	
Stream 2 – Flow measurement	12	51	Simple	Unsigned 8	1	D	R/W	Disabled	0 to 1	
Stream 3 – Flow measurement	12	52	Simple	Unsigned 8	1	D	R/W	Disabled	0 to 1	
Out of sample detection	12	53	Simple	Unsigned 8	1	D	R/W	Disabled	0 to 1	
Stream sequence – Position 1	12	54	Simple	Unsigned 8	1	D	R/W	Daily	0 to 6	
Stream sequence – Position 2	12	55	Simple	Unsigned 8	1	D	R/W	Weekly	0 to 7	
Stream sequence – Position 3	12	56	Simple	Unsigned 8	1	D	R/W	Monthly	0 to 5	
Stream sequence – Position 4	12	57	Simple	Unsigned 8	1	D	R/W	1	0 to 3 0 – End Of Sequence 1 – Stream 1 2 – Stream 2 3 – Stream 3	
Stream sequence – Position 5	12	58	Simple	Unsigned 8	1	D	R/W	2		
Stream sequence – Position 6	12	59	Simple	Unsigned 8	1	D	R/W	1		
Stream sequence – Position 7	12	60	Simple	Unsigned 8	1	D	R/W	2		
Stream sequence – Position 8	12	61	Simple	Unsigned 8	1	D	R/W	1		
Stream 1 – Enable	12	62	Simple	Unsigned 8	1	D	R/W	2		
Stream 2 – Enable	12	63	Simple	Unsigned 8	1	D	R/W	1		
Stream 3 – Enable	12	64	Simple	Unsigned 8	1	D	R/W	2		
Scheduled calibration type	12	65	Simple	Unsigned 8	1	D	R/W	Scheduled calibration disabled	0 to 5	
Scheduled calibration frequency units	12	66	Simple	Unsigned 8	1	D	R/W	Frequency off	0 to 3	
Scheduled calibration frequency daily	12	67	Simple	Unsigned 8	1	D	R/W	Daily	0 to 6	
Scheduled calibration frequency weekly	12	68	Simple	Unsigned 8	1	D	R/W	Weekly	0 to 7	
Scheduled calibration frequency monthly	12	69	Simple	Unsigned 8	1	D	R/W	Monthly	0 to 5	

A.12.3 Slot 12 – operator page template

Description	Slot	Index	Object type	Data type	Bytes	Store	Access	Default	Valid range	Notes
Operator page 2 template	12	70	Simple	Unsigned 8	1	D	R/W	Off	0 to 4	0 – Off 1 – Sensor 1 2 – Sensor 2 3 – Sensor 3 4 – Sensor 4
Operator page 3 template	12	71	Simple	Unsigned 8	1	D	R/W	Off	0 to 4	0 – Off 1 – Sensor 1 2 – Sensor 2 3 – Sensor 3 4 – Sensor 4
Operator page 4 template	12	72	Simple	Unsigned 8	1	D	R/W	Off	0 to 4	0 – Off 1 – Sensor 1 2 – Sensor 2 3 – Sensor 3 4 – Sensor 4
Operator page 5 template	12	73	Simple	Unsigned 8	1	D	R/W	Off	0 to 4	0 – Off 1 – Sensor 1 2 – Sensor 2 3 – Sensor 3 4 – Sensor 4

A.12.4 Slot 12 – view/log enables

Description	Slot	Index	Object type	Data type	Bytes	Store	Access	Default	Valid range	Notes
Diagnostics view	12	74	Simple	Unsigned 8	1	D	R/W	Enabled	0 to 1	0 – Disabled 1 – Enabled
Signals view	12	75	Simple	Unsigned 8	1	D	R/W	Enabled	0 to 1	0 – Disabled 1 – Enabled
Chart view	12	76	Simple	Unsigned 8	1	D	R/W	Disabled	0 to 1	0 – Disabled 1 – Enabled
Alarm view	12	77	Simple	Unsigned 8	1	D	R/W	Disabled	0 to 1	0 – Disabled 1 – Enabled
Analog output view	12	78	Simple	Unsigned 8	1	D	R/W	Disabled	0 to 1	0 – Disabled 1 – Enabled
Calibration log	12	79	Simple	Unsigned 8	1	D	R/W	Disabled	0 to 1	0 – Disabled 1 – Enabled
Alarm log	12	80	Simple	Unsigned 8	1	D	R/W	Disabled	0 to 1	0 – Disabled 1 – Enabled
Audit log	12	81	Simple	Unsigned 8	1	D	R/W	Disabled	0 to 1	0 – Disabled 1 – Enabled
Diagnostics log	12	82	Simple	Unsigned 8	1	D	R/W	Disabled	0 to 1	0 – Disabled 1 – Enabled

A.12.5 Slot 12 – date/time settings

Description	Slot	Index	Object type	Data type	Bytes	Store	Access	Default	Valid range	Notes
Date format	12	83	Simple	Unsigned 8	1	D	R/W	yyyy/mm/dd	0 to 2	0 – dd/mm/yyyy 1 – mm/dd/yyyy 2 – yyyy/mm/dd
Daylight saving – Region	12	84	Simple	Unsigned 8	1	D	R/W	Off	0 to 3	0 – Daylight saving is Off 1 – Europe 2 – USA 3 – Custom
Daylight saving – Start hour for daylight saving	12	85	Simple	Unsigned 8	1	D	R/W	1	0 to 23	
Daylight saving – Start occurrence for daylight saving	12	86	Simple	Unsigned 8	1	D	R/W	Last	1 to 5	1 – First 2 – Second 3 – Third 4 – Fourth 5 – Last
Daylight saving – Start day for daylight saving	12	87	Simple	Unsigned 8	1	D	R/W	Sunday	1 to 7	1 – Sunday 2 – Monday 3 – Tuesday 4 – Wednesday 5 – Thursday 6 – Friday 7 – Saturday
Daylight saving – Start month for daylight saving	12	88	Simple	Unsigned 8	1	D	R/W	March	1 to 12	1 – January 2 – February 3 – March 4 – April 5 – May 6 – June 7 – July 8 – August 9 – September 10 – October 11 – November 12 – December
Daylight saving – End hour for daylight saving	12	89	Simple	Unsigned 8	1	D	R/W	1	0 to 23	
Daylight saving – End Occurance for Daylight Saving	12	90	Simple	Unsigned 8	1	D	R/W	Last	1 to 5	1 – First 2 – Second 3 – Third 4 – Fourth 5 – Last
Daylight saving – End day for daylight saving	12	91	Simple	Unsigned 8	1	D	R/W	Sunday	1 to 7	1 – Sunday 2 – Monday 3 – Tuesday 4 – Wednesday 5 – Thursday 6 – Friday 7 – Saturday

Description	Slot	Index	Object type	Data type	Bytes	Store	Access	Default	Valid range	Notes
Daylight saving – End month for daylight saving	12	92	Simple	Unsigned 8	1	D	R/W	October	1 to 12	1 – January 2 – February 3 – March 4 – April 5 – May 6 – June 7 – July 8 – August 9 – September 10 – October 11 – November 12 – December

A.12.6 Slot 12 – alarm settings

Description	Slot	Index	Object type	Data type	Bytes	Store	Access	Default	Valid range	Notes
Alarm 1 – Type	12	93	Simple	Unsigned 8	1	D	R/W	High process	0 to 4	0 – Off 1 – High process 2 – Low process 3 – High latch 4 – Low latch
Alarm 1 – Source	12	94	Simple	Unsigned 8	1	D	R/W	None	0 to 8	See source list
Alarm 2 – Type	12	95	Simple	Unsigned 8	1	D	R/W	High process	0 to 4	0 – Off 1 – High process 2 – Low process 3 – High latch 4 – Low latch
Alarm 2 – Source	12	96	Simple	Unsigned 8	1	D	R/W	None	0 to 8	See source list
Alarm 3 – Type	12	97	Simple	Unsigned 8	1	D	R/W	High process	0 to 4	0 – Off 1 – High process 2 – Low process 3 – High latch 4 – Low latch
Alarm 3 – Source	12	98	Simple	Unsigned 8	1	D	R/W	None	0 to 8	See source list
Alarm 4 – Type	12	99	Simple	Unsigned 8	1	D	R/W	High process	0 to 4	0 – Off 1 – High process 2 – Low process 3 – High latch 4 – Low latch
Alarm 4 – Source	12	100	Simple	Unsigned 8	1	D	R/W	None	0 to 8	See source list
Alarm 5 – Type	12	101	Simple	Unsigned 8	1	D	R/W	High process	0 to 4	0 – Off 1 – High process 2 – Low process 3 – High latch 4 – Low latch
Alarm 5 – Source	12	102	Simple	Unsigned 8	1	D	R/W	None	0 to 8	See source list
Alarm 6 – Type	12	103	Simple	Unsigned 8	1	D	R/W	High process	0 to 4	0 – Off 1 – High process 2 – Low process 3 – High latch 4 – Low latch
Alarm 6 – Source	12	104	Simple	Unsigned 8	1	D	R/W	None	0 to 8	See source list

Description	Slot	Index	Object type	Data type	Bytes	Store	Access	Default	Valid range	Notes
Alarm 7 – Type	12	105	Simple	Unsigned 8	1	D	R/W	High process	0 to 4	0 – Off 1 – High process 2 – Low process 3 – High latch 4 – Low latch
Alarm 7 – Source	12	106	Simple	Unsigned 8	1	D	R/W	None	0 to 8	See source list
Alarm 8 – Type	12	107	Simple	Unsigned 8	1	D	R/W	High process	0 to 4	0 – Off 1 – High process 2 – Low process 3 – High latch 4 – Low latch
Alarm 8 – Source	12	108	Simple	Unsigned 8	1	D	R/W	None	0 to 8	See source list

A.12.7 Slot 12 – analog output settings

Description	Slot	Index	Object type	Data type	Bytes	Store	Access	Default	Valid range	Notes
Analog output 1 – Source	12	109	Simple	Unsigned 8	1	D	R/W	None	0 to 8	See source list
Analog output 1 – Output type	12	110	Simple	Unsigned 8	1	D	R/W	Linear	0 to 3	0 – Linear 1 – Logarithmic (two decades) 2 – Logarithmic (three decades) 3 – Logarithmic (four decades)
Analog output 1 – Failure current enable	12	111	Simple	Unsigned 8	1	D	R/W	Enabled	0 to 1	0 – Enabled 1 – Disabled
Analog output 2 – Source	12	112	Simple	Unsigned 8	1	D	R/W	None	0 to 8	See source list
Analog output 2 – Output type	12	113	Simple	Unsigned 8	1	D	R/W	Linear	0 to 3	0 – Linear 1 – Logarithmic (two decades) 2 – Logarithmic (three decades) 3 – Logarithmic (four decades)
Analog output 2 – Failure current enable	12	114	Simple	Unsigned 8	1	D	R/W	Enabled	0 to 1	0 – Enabled 1 – Disabled
Analog output 3 – Source	12	115	Simple	Unsigned 8	1	D	R/W	None	0 to 8	See source list
Analog output 3 – Output type	12	116	Simple	Unsigned 8	1	D	R/W	Linear	0 to 3	0 – Linear 1 – Logarithmic (two decades) 2 – Logarithmic (three decades) 3 – Logarithmic (four decades)
Analog output 3 – Failure current enable	12	117	Simple	Unsigned 8	1	D	R/W	Enabled	0 to 1	0 – Enabled 1 – Disabled
Analog output 4 – Source	12	118	Simple	Unsigned 8	1	D	R/W	None	0 to 8	See source list
Analog output 4 – Output type	12	119	Simple	Unsigned 8	1	D	R/W	Linear	0 to 3	0 – Linear 1 – Logarithmic (two decades) 2 – Logarithmic (three decades) 3 – Logarithmic (four decades)
Analog output 4 – Failure current enable	12	120	Simple	Unsigned 8	1	D	R/W	Enabled	0 to 1	0 – Enabled 1 – Disabled

A.12.8 Slot 12 – digital I/O settings

Description	Slot	Index	Object type	Data type	Bytes	Store	Access	Default	Valid range	Notes
Digital I/O 1 – Type	12	121	Simple	Unsigned 8	1	D	R/W	Off	0 to 3	0 – Off 1 – Digital output 2 – Digital input (voltage-free) 3 – Digital input (24 Volt)
Digital I/O 1 – Source	12	122	Simple	Unsigned 8	1	D	R/W	None	0 and 9 to 64	See source list
Digital I/O 1 – Polarity	12	123	Simple	Unsigned 8	1	D	R/W	Non inverted	0 to 1	0 – Inverted 1 – Non inverted
Digital I/O 2 – Type	12	124	Simple	Unsigned 8	1	D	R/W	Off	0 to 3	0 – Off 1 – Digital output 2 – Digital input (voltage-free) 3 – Digital input (24 Volt)
Digital I/O 2 – Source	12	125	Simple	Unsigned 8	1	D	R/W	None	0 and 9 to 64	0 – None 1 – Sensor 1 concentration 2 – Sensor 2 concentration 3 – Sensor 3 concentration 4 – Sensor 4 concentration 5 – Sensor 1 temperature 6 – Sensor 2 temperature 7 – Sensor 3 temperature 8 – Sensor 4 temperature
Digital I/O 2 – Polarity	12	126	Simple	Unsigned 8	1	D	R/W	Non inverted	0 to 1	0 – Inverted 1 – Non inverted
Digital I/O 3 – Type	12	127	Simple	Unsigned 8	1	D	R/W	Off	0 to 3	0 – Off 1 – Digital output 2 – Digital input (voltage-free) 3 – Digital input (24 Volt)
Digital I/O 3 – Source	12	128	Simple	Unsigned 8	1	D	R/W	None	0 and 9 to 64	See source list
Digital I/O 3 – Polarity	12	129	Simple	Unsigned 8	1	D	R/W	Non inverted	0 to 1	0 – Inverted 1 – Non inverted
Digital I/O 4 – Type	12	130	Simple	Unsigned 8	1	D	R/W	Off	0 to 3	0 – Off 1 – Digital output 2 – Digital input (voltage-free) 3 – Digital input (24 Volt)
Digital I/O 4 – Source	12	131	Simple	Unsigned 8	1	D	R/W	None	0 and 9 to 64	See source list
Digital I/O 4 – Polarity	12	132	Simple	Unsigned 8	1	D	R/W	Non inverted	0 to 1	0 – Inverted 1 – Non inverted
Digital I/O 5 – Type	12	133	Simple	Unsigned 8	1	D	R/W	Off	0 to 3	0 – Off 1 – Digital output 2 – Digital input (voltage-free) 3 – Digital input (24 Volt)
Digital I/O 5 – Source	12	134	Simple	Unsigned 8	1	D	R/W	None	0 and 9 to 64	See source list
Digital I/O 5 – Polarity	12	135	Simple	Unsigned 8	1	D	R/W	Non inverted	0 to 1	0 – Inverted 1 – Non inverted
Digital I/O 6 – Type	12	136	Simple	Unsigned 8	1	D	R/W	Off	0 to 3	0 – Off 1 – Digital output 2 – Digital input (voltage-free) 3 – Digital input (24 Volt)
Digital I/O 6 – Source	12	137	Simple	Unsigned 8	1	D	R/W	None	0 and 9 to 64	See source list
Digital I/O 6 – Polarity	12	138	Simple	Unsigned 8	1	D	R/W	Non inverted	0 to 1	0 – Inverted 1 – Non inverted

A.12.9 Slot 12 – relay settings

Description	Slot	Index	Object type	Data type	Bytes	Store	Access	Default	Valid range	Notes
Relay 1 – Source	12	139	Simple	Unsigned 8	1	D	R/W	None	0 and 9 to 44	
Relay 1 – Polarity	12	140	Simple	Unsigned 8	1	D	R/W	Non inverted	0 to 1	0 – Inverted 1 – Non inverted
Relay 2 – Source	12	141	Simple	Unsigned 8	1	D	R/W	None	0 and 9 to 44	
Relay 2 – Polarity	12	142	Simple	Unsigned 8	1	D	R/W	Non inverted	0 to 1	0 – Inverted 1 – Non inverted
Relay 3 – Source	12	143	Simple	Unsigned 8	1	D	R/W	None	0 and 9 to 44	
Relay 3 – Polarity	12	144	Simple	Unsigned 8	1	D	R/W	Non inverted	0 to 1	0 – Inverted 1 – Non inverted
Relay 4 – Source	12	145	Simple	Unsigned 8	1	D	R/W	None	0 and 9 to 44	
Relay 4 – Polarity	12	146	Simple	Unsigned 8	1	D	R/W	Non inverted	0 to 1	0 – Inverted 1 – Non inverted
Relay 5 – Source	12	147	Simple	Unsigned 8	1	D	R/W	None	0 and 9 to 44	
Relay 5 – Polarity	12	148	Simple	Unsigned 8	1	D	R/W	Non inverted	0 to 1	0 – Inverted 1 – Non inverted
Relay 6 – Source	12	149	Simple	Unsigned 8	1	D	R/W	None	0 and 9 to 44	
Relay 6 – Polarity	12	150	Simple	Unsigned 8	1	D	R/W	Non inverted	0 to 1	0 – Inverted 1 – Non inverted

A.13

A.13.1 Slot 13 – tags

Description	Slot	Index	Object type	Data type	Bytes	Store	Access	Default	Valid range
Instrument tag	13	0	Simple	Visible string	16	C	R/W	Navigator	ASCII String
Process tag 1	13	1	Simple	Visible string	16	C	R/W	Tag 1	
Process tag 2	13	2	Simple	Visible string	16	C	R/W	Tag 2	
Process tag 3	13	3	Simple	Visible string	16	C	R/W	Tag 3	
Process tag 4	13	4	Simple	Visible string	16	C	R/W	Tag 4	
Alarm 1 tag	13	5	Simple	Visible string	16	C	R/W	Alarm 1	
Alarm 2 tag	13	6	Simple	Visible string	16	C	R/W	Alarm 2	
Alarm 3 tag	13	7	Simple	Visible string	16	C	R/W	Alarm 3	
Alarm 4 tag	13	8	Simple	Visible string	16	C	R/W	Alarm 4	
Alarm 5 tag	13	9	Simple	Visible string	16	C	R/W	Alarm 5	
Alarm 6 tag	13	10	Simple	Visible string	16	C	R/W	Alarm 6	
Alarm 7 tag	13	11	Simple	Visible string	16	C	R/W	Alarm 7	
Alarm 8 tag	13	12	Simple	Visible string	16	C	R/W	Alarm 8	
Chart config tag 1	13	13	Simple	Visible string	3	C	R/W	Ch 1	
Chart config tag 2	13	14	Simple	Visible string	3	C	R/W	Ch 2	
Chart config tag 3	13	15	Simple	Visible string	3	C	R/W	Ch 3	
Chart config tag 4	13	16	Simple	Visible string	3	C	R/W	Ch 4	

Appendix B – Modbus tables

B.1 Register tables

Table name	Table type	Data type	Start address	End address
Digital I/O status	Input coils	Unsigned 8 bit	0	999
Alarm acknowledgement	Output coils	Unsigned 8 bit	0	499
Action commands	Output coils	Unsigned 8 bit	500	949
Read-only single precision float parameters	Input registers	Float	30000	30999
Read-only 32 bit parameters	Input registers	Unsigned 32 bit	31000	31999
Read-only 16 bit parameters	Input registers	Unsigned 16 bit	32000	32999
Read-only 8 bit parameters	Input registers	Unsigned 8 bit	33000	33999
Read-only string parameters	Input registers	Unsigned 8 bit	34000	34999
Read/Write single precision float parameters	Holding registers	Float	40000	40999
Read/Write 16 bit parameters	Holding registers	Unsigned 16 bit	42000	42999
Read/Write 8 bit parameters	Holding registers	Unsigned 8 bit	43000	43999
Read/Write string parameters	Holding registers	Unsigned 8 bit	44000	44999

B.2 Digital I/O status

Modbus address	Description	Notes
152	Digital output 1 state	0 – Low 1 – High
153	Digital output 2 state	
154	Digital output 3 state	
155	Digital output 4 state	
156	Digital output 5 state	
157	Digital output 6 state	
158	Digital input 1 state	
159	Digital input 2 state	
160	Digital input 3 state	
161	Digital input 4 state	
162	Digital input 5 state	
163	Digital input 6 state	

Table B.1: Digital I/O status (input coils)

B.3 Alarm acknowledgement

Modbus address	Description	Notes
0	Alarm 1 acknowledge state	0 – Unacknowledged 1 – Acknowledged
1	Alarm 2 acknowledge state	
2	Alarm 3 acknowledge state	
3	Alarm 4 acknowledge state	
4	Alarm 5 acknowledge state	
5	Alarm 6 acknowledge state	
6	Alarm 7 acknowledge state	
7	Alarm 8 acknowledge state	
8	Acknowledge alarm 1	
9	Acknowledge alarm 2	
10	Acknowledge alarm 3	
11	Acknowledge alarm 4	
12	Acknowledge alarm 5	
13	Acknowledge alarm 6	
14	Acknowledge alarm 7	
15	Acknowledge alarm 8	

Table B.2: Alarm acknowledgement (output coils)

B.4 Action commands

Modbus address	Description	Notes
500	Start zero calibration sensor 1	Writing any value from 0 to 255 starts the procedure. Calibration through modbus is not possible for ADS551 sensors.
501	Start span calibration sensor 1	
502	Start two point calibration sensor 1	
503	Start regeneration sensor 1	
504	Start zero calibration sensor 2	
505	Start span calibration sensor 2	
506	Start two point calibration sensor 2	
507	Start regeneration sensor 2	
508	Start zero calibration sensor 3	
509	Start span calibration sensor 3	
510	Start two point calibration sensor 3	
511	Start regeneration sensor 3	
512	Start zero calibration sensor 4	
513	Start span calibration sensor 4	
514	Start two point calibration sensor 4	
515	Start regeneration sensor 4	

Table B.3: Action commands (output coils)

B.5 Read-only, single precision float

Modbus address	Description	Notes
30000	Sensor 1 – Concentration	See engineering range table (Appendix C, page 52)
30002	Sensor 1 – Temperature	
30004	Sensor 2 – Concentration	
30006	Sensor 2 – Temperature	
30008	Sensor 3 – Concentration	
30010	Sensor 3 – Temperature	
30012	Sensor 4 – Concentration	
30014	Sensor 4 – Temperature	

Table B.4: Measurement values (input coils)

Modbus address	Description	Notes	
30016	Sensor 1 – Concentration	Single-stream sensor 1	
30018	Sensor 1 – Temperature		
30020	Sensor 1 – Raw signal		
30022	Sensor 1 – Flow rate		
30024	Sensor 1 – Active calibration slope		
30026	Sensor 1 – Active calibration offset		
30028	Sensor 1 – Last calibration slope		
30030	Sensor 1 – Last calibration offset		
30032	Sensor 2 – Concentration		Single-stream sensor 2
30034	Sensor 2 – Temperature		
30036	Sensor 2 – Raw signal		
30038	Sensor 2 – Flow rate		
30040	Sensor 2 – Active calibration slope		
30042	Sensor 2 – Active calibration offset		
30044	Sensor 2 – Last calibration slope		
30046	Sensor 2 – Last calibration offset		
30048	Sensor 3 – Concentration	Single-stream sensor 3	
30050	Sensor 3 – Temperature		
30052	Sensor 3 – Raw signal		
30054	Sensor 3 – Flow rate		
30056	Sensor 3 – Active calibration slope		
30058	Sensor 3 – Active calibration offset		
30060	Sensor 3 – Last calibration slope		
30062	Sensor 3 – Last calibration offset		
30064	Sensor 4 – Concentration		Single-stream sensor 4
30066	Sensor 4 – Temperature		
30068	Sensor 4 – Raw signal		
30070	Sensor 4 – Flow rate		
30072	Sensor 4 – Active calibration slope		
30074	Sensor 4 – Active calibration offset		
30076	Sensor 4 – Last calibration slope		
30078	Sensor 4 – Last calibration offset		
30080	Stream 1 – Concentration	Two-stream sensor	
30082	Stream 1 – Temperature		
30084	Stream 2 – Concentration		
30086	Stream 2 – Temperature		
30088	Raw signal		
30090	Stream 1 – Flow rate		
30092	Stream 2 – Flow rate		
30094	Active calibration slope		
30096	Active calibration offset		
30098	Last calibration slope		
30100	Last calibration offset		

Table B.5: Sensor signals view

Modbus address	Description	Notes
30102	Stream 1 – Concentration	Three-stream sensor
30104	Stream 1 – Temperature	
30106	Stream 2 – Concentration	
30108	Stream 2 – Temperature	
30110	Stream 3 – Concentration	
30112	Stream 3 – Temperature	
30114	Raw signal	
30116	Stream 1 – Flow rate	
30118	Stream 2 – Flow rate	
30120	Stream 3 – Flow rate	
30122	Active calibration slope	
30124	Active calibration offset	
30126	Last calibration slope	
30128	Last calibration offset	

Table B.5: Sensor signals view (Continued)

Modbus address	Description	Notes
30130	Concentration – Eng. range high S1	See engineering range table (Appendix C, page 52)
30132	Concentration – Eng. range low S1	
30134	Temperature – Eng. range high S1	
30136	Temperature – Eng. range low S1	
30138	Concentration – Eng. range high S2	
30140	Concentration – Eng. range low S2	
30142	Temperature – Eng. range high S2	
30144	Temperature – Eng. range low S2	
30146	Concentration – Eng. range high S3	
30148	Concentration – Eng. range low S3	
30150	Temperature – Eng. range high S3	
30152	Temperature – Eng. range low S3	
30154	Concentration – Eng. range high S4	
30156	Concentration – Eng. range low S4	
30158	Temperature – Eng. range high S4	
30160	Temperature – Eng. range low S4	

Table B.6: Measurement range limits

Modbus address	Description
30162	Analog output value (mA) AOUT1
30164	Analog output value (mA) AOUT2
30166	Analog output value (mA) AOUT3
30168	Analog output value (mA) AOUT4
30170	Analog output % of full scale AOUT1
30172	Analog output % of full scale AOUT2
30174	Analog output % of full scale AOUT3
30176	Analog output % of full scale AOUT4

Table B.7: Analog outputs

B.6 Read-only, 32 bits

Modbus address	Description	Notes
31000	Transmitter – Date of manufacture	number of seconds since 01/01/2000

Table B.8: Transmitter date

Modbus address	Description	Notes
31002	Sensor 1 – Date of manufacture	number of seconds since 01/01/2000
31004	Sensor 2 – Date of manufacture	
31006	Sensor 3 – Date of manufacture	
31008	Sensor 4 – Date of manufacture	

Table B.9: Sensor dates

Modbus address	Description	Notes
31010	Sensor 1 – Next scheduled calibration time	number of seconds since 01/01/2000
31012	Sensor 2 – Next scheduled calibration time	
31014	Sensor 3 – Next scheduled calibration time	
31016	Sensor 4 – Next scheduled calibration time	

Table B.10: Next scheduled calibration time

Modbus address	Description	Notes
31018	Stream 1 – Update time	
31020	Stream 2– Update time	
31022	Stream 3 – Update time (3-stream sensor only)	

Table B.11: Multi-Stream sensor sampling time stamps (multi-stream sensors only)

B.7 Read-only, 16 bits

Modbus address	Description
32000	Sensor 1 – Hardware version number
32001	Sensor 2 – Hardware version number
32002	Sensor 3 – Hardware version number
32003	Sensor 4 – Hardware version number

Table B.12: Sensor hardware version (valid range 1 to 9)

B.8 Read-only 8 bits

Modbus address	Description	Notes
33000	Sensor 1 – Type	0 – Unrecognized 12 – Sodium 13 – Sodium two-stream 14 – Sodium three-stream 15, 18 and 19 – Low level dissolved oxygen 16 – Hydrazine 255 – No sensor fitted
33001	Sensor 1 – Flow sensor fitted	0 – Disabled 1 – Enabled
33002	Sensor 1 – Regeneration hardware fitted	0 – Disabled 1 – Enabled
33003	Sensor 2 – Type	0 – Unrecognized 12 – Sodium 13 – Sodium two-stream 14 – Sodium three-stream 15, 18 and 19 – Low level dissolved oxygen 16 – Hydrazine 255 – No sensor fitted
33004	Sensor 2 – Flow sensor fitted	0 – Disabled 1 – Enabled
33005	Sensor 2 – Regeneration hardware fitted	0 – Disabled 1 – Enabled
33006	Sensor 3 – Type	0 – Unrecognized 12 – Sodium 13 – Sodium two-stream 14 – Sodium three-stream 15, 18 and 19 – Low level dissolved oxygen 16 – Hydrazine 255 – No sensor fitted
33007	Sensor 3 – Flow sensor fitted	0 – Disabled 1 – Enabled
33008	Sensor 3 – Regeneration hardware fitted	0 – Disabled 1 – Enabled
33009	Sensor 4 – Type	0 – Unrecognized 12 – Sodium 13 – Sodium two-stream 14 – Sodium three-stream 15, 18 and 19 – Low level dissolved oxygen 16 – Hydrazine 255 – No sensor fitted
33010	Sensor 4 – Flow sensor fitted	0 – Disabled 1 – Enabled
33011	Sensor 4 – Regeneration hardware fitted	0 – Disabled 1 – Enabled

Table B.13: Sensor type and hardware options

Modbus address	Description
33012	Media card hardware version number

Table B.14: Media card version

B.9 Read-only strings

Modbus address	Description	No. of Bytes
34000	Transmitter software revision number	19
34019	Transmitter serial number	14
34033	Sensor 1 software revision number	19
34052	Sensor 1 serial number	14
34066	Sensor 2 software revision number	19
34085	Sensor 2 Serial number	14
34099	Sensor 3 software revision number	19
34118	Sensor 3 Serial number	14
34132	Sensor 4 software revision number	19
34151	Sensor 4 serial number	14
34165	Media card software version number	19

Table B.15: Serial numbers

B.10 Writable floats

Modbus address	Description	Notes
40000	Chart – Trace 1 – range high	Range from engineering range low to engineering range high. See engineering range table – Appendix C, page 52
40002	Chart – Trace 1 – range low	
40004	Chart – Trace 2 – range high	
40006	Chart – Trace 2 – range low	
40008	Chart – Trace 3 – range high	
40010	Chart – Trace 3 – range low	
40012	Chart – Trace 4 – range high	
40014	Chart – Trace 4 – range low	

Table B.16: Chart trace range

Modbus address	Description	Notes
40016	Alarm 1 – Trip point	Range from engineering range low to engineering range high. See engineering range table – Appendix C, page 52
40018	Alarm 2 – Trip point	
40020	Alarm 3 – Trip point	
40022	Alarm 4 – Trip point	
40024	Alarm 5 – Trip point	
40026	Alarm 6 – Trip point	
40028	Alarm 7 – Trip point	
40030	Alarm 8 – Trip point	
40032	Alarm 1 – Hysteresis	
40034	Alarm 2 – Hysteresis	
40036	Alarm 3 – Hysteresis	
40038	Alarm 4 – Hysteresis	
40040	Alarm 5 – Hysteresis	
40042	Alarm 6 – Hysteresis	
40044	Alarm 7 – Hysteresis	
40046	Alarm 8 – Hysteresis	

Table B.17: Alarm settings

Modbus address	Description	Notes
40048	Analog output 1 – Electrical range high	0 – 22 mA
40050	Analog output 1 – Electrical range low	
40052	Analog output 1 – Engineering range high	Range from engineering range low to engineering range high. See engineering range table – Appendix C, page 52
40054	Analog output 1 – Engineering range low	
40056	Analog output 2 – Electrical range high	0 – 22 mA
40058	Analog output 2 – Electrical range low	
40060	Analog output 2 – Engineering range high	Range from engineering range low to engineering range high. See engineering range table – Appendix C, page 52
40062	Analog output 2 – Engineering range low	
40064	Analog output 3 – Electrical range high	0 – 22 mA
40066	Analog output 3 – Electrical range low	
40068	Analog output 3 – Engineering range high	Range from engineering range low to engineering range high. See engineering range table – Appendix C, page 52
40070	Analog output 3 – Engineering range low	
40072	Analog output 4 – Electrical range high	0 – 22 mA
40074	Analog output 4 – Electrical range low	
40076	Analog output 4 – Engineering range high	Range from engineering range low to engineering range high. See engineering range table – Appendix C, page 52
40078	Analog output 4 – Engineering range low	
40080	Analog output 1 – Failure current	0 – 22 mA
40082	Analog output 2 – Failure current	
40084	Analog output 3 – Failure current	
40086	Analog output 4 – Failure current	

Table B.18: Analog output settings

B.11 Writable, 16 bits

Modbus address	Description	Notes
42000	Sensor 1 – Recovery time	
42001	Sensor 1 – Salinity correction	Low level dissolved oxygen sensors only
42002	Sensor 1 – Pressure compensation	
42003	Sensor 1 – Grab sample sampling time	Sodium sensors only
42004	Sensor 2 – Recovery time	
42005	Sensor 2 – Salinity correction	Low level sensors dissolved oxygen only
42006	Sensor 2 – Pressure compensation	
42007	Sensor 2 – Grab sample sampling time	Sodium sensors only
42008	Sensor 3 – Recovery time	
42009	Sensor 3 – Salinity correction	Low level sensors dissolved oxygen only
42010	Sensor 3 – Pressure compensation	
42011	Sensor 3 – Grab sample sampling time	Sodium sensors only
42012	Sensor 4 – Recovery time	
42013	Sensor 4 – Salinity correction	Low level dissolved oxygen sensors only
42014	Sensor 4 – Pressure compensation	
42015	Sensor 4 – Grab sample sampling time	Sodium sensors only
42016	Stream sample rate	Sodium multi-stream sensor only

Table B.19: Writable 16 bits

Modbus address	Description	Notes
42017	Alarm 1 – Time hysteresis	Valid range 0 to 9999 seconds
42018	Alarm 2 – Time hysteresis	
42019	Alarm 3 – Time hysteresis	
42020	Alarm 4 – Time hysteresis	
42021	Alarm 5 – Time hysteresis	
42022	Alarm 6 – Time hysteresis	
42023	Alarm 7 – Time hysteresis	
42024	Alarm 8 – Time hysteresis	

Table B.20: Alarm time hysteresis

B.12 Writable, 8 bits

Modbus address	Description	Valid range
43000	Transmitter – Temperature units	13 – Deg.C 14 – Deg. F
43001	Sensor 1 – Concentration units	7 – ppb 8 – ug/l 9 – ug/Kg
43002	Sensor 1 – Filter type	0 – Off 1 – Minimum value 2 – Maximum value 3 – Average value 4 – Sliding average
43003	Sensor 1 – Filter time	5 to 100 Samples / Seconds
43004	Sensor 1 – Wetting routine procedure	0 – Disabled 1 – Enabled
43005	Sensor 1 – Flow measurement	0 – Disabled 1 – Enabled
43006	Sensor 1 – Out of sample detection	0 – Disabled 1 – Enabled
43007	Sensor 1 – Scheduled calibration type	0 – Scheduled calibration disabled 1 – One point calibration (low standard) 2 – One point calibration (high standard) 3 – Two point calibration 4 – Regeneration + two point calibration 5 – One point air calibration
43008	Sensor 1 – Scheduled calibration frequency units	0 – Frequency off 1 – Daily 2 – Weekly 3 – Monthly
43009	Sensor 1 – Scheduled calibration frequency daily	0 – Daily 1 – Two days 2 – Three days 3 – Four days 4 – Five days 5 – Six days 6 – Seven days
43010	Sensor 1 – Scheduled calibration frequency weekly	0 – Weekly 1 – Two weeks 2 – Three weeks 3 – Four weeks 4 – Five weeks 5 – Six weeks 6 – Seven weeks 7 – Eight weeks
43011	Sensor 1 – Scheduled calibration frequency monthly	0 – Monthly 1 – Two months 2 – Three months 3 – Four months 4 – Six months 5 – Twelve months

Table B.21: Single-stream sensors – Units, filter and scheduled calibration configuration

Modbus address	Description	Valid range
43012	Sensor 2 – Concentration units	7 – ppb 8 – ug/l 9 – ug/Kg
43013	Sensor 2 – Filter type	0 – Off 1 – Minimum value 2 – Maximum value 3 – Average value 4 – Sliding average
43014	Sensor 2 – Filter time	5 to 100 Samples / Seconds
43015	Sensor 2 – Wetting routine procedure	0 – Disabled 1 – Enabled
43016	Sensor 2 – Flow measurement	0 – Disabled 1 – Enabled
43017	Sensor 2 – Out of sample detection	0 – Disabled 1 – Enabled
43018	Sensor 2 – Scheduled calibration type	0 – Scheduled calibration disabled 1 – One point calibration (low standard) 2 – One point calibration (high standard) 3 – Two point calibration 4 – Regeneration + two point calibration 5 – One point air calibration
43019	Sensor 2 – Scheduled calibration frequency units	0 – Frequency off 1 – Daily 2 – Weekly 3 – Monthly
43020	Sensor 2 – Scheduled calibration frequency daily	0 – Daily 1 – Two days 2 – Three days 3 – Four days 4 – Five days 5 – Six days 6 – Seven days
43021	Sensor 2 – Scheduled calibration frequency weekly	0 – Weekly 1 – Two weeks 2 – Three weeks 3 – Four weeks 4 – Five weeks 5 – Six weeks 6 – Seven weeks 7 – Eight weeks
43022	Sensor 2 – Scheduled calibration frequency monthly	0 – Monthly 1 – Two months 2 – Three months 3 – Four months 4 – Six months 5 – Twelve months
43023	Sensor 3 – Concentration units	7 – ppb 8 – ug/l 9 – ug/Kg

Table B.21: Single-stream sensors – Units, filter and scheduled calibration configuration (Continued)

Modbus address	Description	Valid range
43024	Sensor 3 – Filter type	0 – Off 1 – Minimum value 2 – Maximum value 3 – Average value 4 – Sliding average
43025	Sensor 3 – Filter time	5 to 100 Samples / Seconds
43026	Sensor 3 – Wetting routine procedure	0 – Disabled 1 – Enabled
43027	Sensor 3 – Flow measurement	0 – Disabled 1 – Enabled
43028	Sensor 3 – Out of sample detection	0 – Disabled 1 – Enabled
43029	Sensor 3 – Scheduled calibration type	0 – Scheduled calibration disabled 1 – One point calibration (low standard) 2 – One point calibration (high standard) 3 – Two point calibration 4 – Regeneration + two point calibration 5 – One point air calibration
43030	Sensor 3 – Scheduled calibration frequency units	0 – Frequency off 1 – Daily 2 – Weekly 3 – Monthly
43031	Sensor 3 – Scheduled calibration frequency daily	0 – Daily 1 – Two days 2 – Three days 3 – Four days 4 – Five days 5 – Six days 6 – Seven days
43032	Sensor 3 – Scheduled calibration frequency weekly	0 – Weekly 1 – Two weeks 2 – Three weeks 3 – Four weeks 4 – Five weeks 5 – Six weeks 6 – Seven weeks 7 – Eight weeks
43033	Sensor 3 – Scheduled calibration frequency monthly	0 – Monthly 1 – Two months 2 – Three months 3 – Four months 4 – Six months 5 – Twelve months
43034	Sensor 4 – Concentration units	7 – ppb 8 – ug/l 9 – ug/Kg

Table B.21: Single-stream sensors – Units, filter and scheduled calibration configuration (Continued)

Modbus address	Description	Valid range
43035	Sensor 4 – Filter type	0 – Off 1 – Minimum value 2 – Maximum value 3 – Average value 4 – Sliding average
43036	Sensor 4 – Filter time	5 to 100 Samples / Seconds
43037	Sensor 4 – Wetting routine procedure	0 – Disabled 1 – Enabled
43038	Sensor 4 – Flow measurement	0 – Disabled 1 – Enabled
43039	Sensor 4 – Out of sample detection	0 – Disabled 1 – Enabled
43040	Sensor 4 – Scheduled calibration type	0 – Scheduled calibration disabled 1 – One point calibration (low standard) 2 – One point calibration (high standard) 3 – Two point calibration 4 – Regeneration + two point calibration 5 – One point air calibration
43041	Sensor 4 – Scheduled calibration frequency units	0 – Frequency off 1 – Daily 2 – Weekly 3 – Monthly
43042	Sensor 4 – Scheduled calibration frequency daily	0 – Daily 1 – Two days 2 – Three days 3 – Four days 4 – Five days 5 – Six days 6 – Seven days
43043	Sensor 4 – Scheduled calibration frequency weekly	0 – Weekly 1 – Two weeks 2 – Three weeks 3 – Four weeks 4 – Five weeks 5 – Six weeks 6 – Seven weeks 7 – Eight weeks
43044	Sensor 4 – Scheduled calibration frequency monthly	0 – Monthly 1 – Two months 2 – Three months 3 – Four months 4 – Six months 5 – Twelve months

Table B.21: Single-stream sensors – Units, filter and scheduled calibration configuration (Continued)

Modbus address	Description	Valid range
43045	Transmitter – temperature units	13 - Deg.C 14 - Deg. F
43046	Concentration units	7 – ppb 8 – ug/l 9 – ug/Kg
43047	Filter type	0 – Off 1 – Minimum value 2 – Maximum value 3 – Average value 4 – Sliding average
43048	Filter time	5 to 100 Samples / Seconds
43049	Wetting routine procedure	0 – Disabled 1 – Enabled
43050	Stream 1 – Flow measurement	0 – Disabled 1 – Enabled
43051	Stream 2 – Flow measurement	0 – Disabled 1 – Enabled
43052	Stream 3 – Flow measurement	0 – Disabled 1 – Enabled
43053	Out of sample detection	0 – Disabled 1 – Enabled
43054	Stream sequence - Position 1	0 to 3 0 – End of sequence 1 – Stream 1 2 – Stream 2 3 – Stream 3
43055	Stream sequence - Position 2	0 to 3 0 – End of sequence 1 – Stream 1 2 – Stream 2 3 – Stream 3
43056	Stream sequence - Position 3	0 to 3 0 – End of sequence 1 – Stream 1 2 – Stream 2 3 – Stream 3
43057	Stream sequence - Position 4	0 to 3 0 – End of sequence 1 – Stream 1 2 – Stream 2 3 – Stream 3
43058	Stream sequence - Position 5	0 to 3 0 – End of sequence 1 – Stream 1 2 – Stream 2 3 – Stream 3
43059	Stream sequence - Position 6	0 to 3 0 – End of sequence 1 – Stream 1 2 – Stream 2 3 – Stream 3

Table B.22: Multi-stream sensors – units, filter and scheduled calibration configuration

Modbus address	Description	Valid range
43060	Stream sequence - Position 7	0 to 3 0 – End of sequence 1 – Stream 1 2 – Stream 2 3 – Stream 3
43061	Stream sequence - Position 8	0 to 3 0 – End of sequence 1 – Stream 1 2 – Stream 2 3 – Stream 3
43062	Stream 1 - Enable	0 – Disabled 1 – Enabled
43063	Stream 2 - Enable	0 – Disabled 1 – Enabled
43064	Stream 3 - Enable	0 – Disabled 1 – Enabled
43065	Scheduled calibration type	0 – Scheduled calibration disabled 1 – One point calibration (low standard) 2 – One point calibration (high standard) 3 – Two point calibration 4 – Regeneration + two point calibration 5 – One point air calibration
43066	Scheduled calibration frequency units	0 – Frequency off 1 – Daily 2 – Weekly 3 – Monthly
43067	Scheduled calibration frequency daily	0 – Daily 1 – Two days 2 – Three days 3 – Four days 4 – Five days 5 – Six days 6 – Seven days
43068	Scheduled calibration frequency weekly	0 – Weekly 1 – Two weeks 2 – Three weeks 3 – Four weeks 4 – Five weeks 5 – Six weeks 6 – Seven weeks 7 – Eight weeks
43069	Scheduled calibration frequency monthly	0 – Monthly 1 – Two months 2 – Three months 3 – Four months 4 – Six months 5 – Twelve months

Table B.22: Multi-stream sensors – units, filter and scheduled calibration configuration (Continued)

Modbus address	Description	Valid range
43070	Operator page 2 template	0 – Off
43071	Operator page 3 template	1 – Sensor 1
43072	Operator page 4 template	2 – Sensor 2
43073	Operator page 5 template	3 – Sensor 3 4 – Sensor 4

Table B.23: Operator page templates

Modbus address	Description	Valid range
43074	Diagnostics view	0 – Disabled
43075	Signals view	1 – Enabled
43076	Chart view	
43077	Alarm view	
43078	Analog output view	
43079	Calibration log	
43080	Alarm log	
43081	Audit log	
43082	Diagnostics log	

Table B.24: Data view / log enables

Modbus address	Description	Valid range
43083	Date format	0 – dd/mm/yyyy 1 – mm/dd/yyyy 2 – yyyy/mm/dd
43084	Daylight saving – region	0 – Daylight saving Off 1 – Europe 2 – USA 3 – Custom
43085	Daylight saving – start hour for daylight saving	0 to 23
43086	Daylight saving – start occurrence for daylight saving	1 – First 2 – Second 3 – Third 4 – Fourth 5 – Last
43087	Daylight saving – start day for daylight saving	1 – Sunday 2 – Monday 3 – Tuesday 4 – Wednesday 5 – Thursday 6 – Friday 7 – Saturday

Table B.25: Date display settings

Modbus address	Description	Valid range
43088	Daylight saving – start month for daylight saving	1 – January 2 – February 3 – March 4 – April 5 – May 6 – June 7 – July 8 – August 9 – September 10 – October 11 – November 12 – December
43089	Daylight saving – end hour for daylight saving	0 to 23
43090	Daylight saving – end occurrence for daylight saving	1 – First 2 – Second 3 – Third 4 – Fourth 5 – Last
43091	Daylight saving – end day for daylight saving	1 – Sunday 2 – Monday 3 – Tuesday 4 – Wednesday 5 – Thursday 6 – Friday 7 – Saturday
43092	Daylight saving - end month for daylight saving	1 – January 2 – February 3 – March 4 – April 5 – May 6 – June 7 – July 8 – August 9 – September 10 – October 11 – November 12 – December

Table B.25: Date display settings (Continued)

Modbus address	Description	Valid range
43093	Alarm 1 – Type	0 – Off 1 – High process 2 – Low process 3 – High latch 4 – Low latch
43094	Alarm 1 – Source	0 to 8 – see Table C.3, page 52
43095	Alarm 2 – Type	See Alarm 1 – Type
43096	Alarm 2 – Source	See Alarm 1 – Source
43097	Alarm 3 – Type	See Alarm 1 – Type
43098	Alarm 3 – Source	See Alarm 1 – Source
43099	Alarm 4 – Type	See Alarm 1 – Type
43100	Alarm 4 – Source	See Alarm 1 – Source
43101	Alarm 5 – Type	See Alarm 1 – Type
43102	Alarm 5 – Source	See Alarm 1 – Source
43103	Alarm 6 – Type	See Alarm 1 – Type
43104	Alarm 6 – Source	See Alarm 1 – Source
43105	Alarm 7 – Type	See Alarm 1 – Type
43106	Alarm 7 – Source	See Alarm 1 – Source
43107	Alarm 8 – Type	See Alarm 1 – Type
43108	Alarm 8 – Source	See Alarm 1 – Source

Table B.26: Alarm settings

Modbus address	Description	Valid range
43109	Analog output 1 – Source	0 to 8 – see Table C.2, page 52
43110	Analog output 1 – Output type	0 – Linear 1 – Logarithmic (2 decades) 2 – Logarithmic (3 decades) 3 – Logarithmic (4 decades)
43111	Analog output 1 – Failure current enable	0 – Enabled 1 – Disabled
43112	Analog output 2 – Source	See Analog output 1 – Source
43113	Analog output 2 – Output type	See Analog output 1 – Output type
43114	Analog output 2 – Failure current enable	0 – Enabled 1 – Disabled
43115	Analog output 3 – Source	See Analog output 1 – Source
43116	Analog output 3 – Output type	See Analog output 1 – Output type
43117	Analog output 3 – Failure current enable	0 – Enabled 1 – Disabled
43118	Analog output 4 – Source	See Analog output 1 – Source
43119	Analog output 4 – Output type	See Analog output 1 – Output type
43120	Analog output 4 – failure current enable	0 – Enabled 1 – Disabled

Table B.27: Analog output settings

Modbus address	Description	Valid range
43121	Digital I/O 1 – Type	0 – Off 1 – Digital output 2 – Digital input (volt-free) 3 – Digital input (24 V)
43122	Digital I/O 1 – Source	0, and 9 to 52 (output) 0, and 53 to 60 (input) See Table C.3, page 52.
43123	Digital I/O 1 – Polarity	0 – Inverted 1 – Non inverted
43124	Digital I/O 2 – Type	See Digital I/O 1 – Type
43125	Digital I/O 2 – Source	See Digital I/O 1 – Source
43126	Digital I/O 2 – Polarity	0 – Inverted 1 – Non inverted
43127	Digital I/O 3 – Type	See Digital I/O 1 – Type
43128	Digital I/O 3 – Source	See Digital I/O 1 – Source
43129	Digital I/O 3 – Polarity	0 – Inverted 1 – Non inverted
43130	Digital I/O 4 – Type	See Digital I/O 1 – Type
43131	Digital I/O 4 – Source	See Digital I/O 1 – Source
43132	Digital I/O 4 – Polarity	0 – Inverted 1 – Non inverted
43133	Digital I/O 5 – Type	See Digital I/O 1 – Type
43134	Digital I/O 5 – Source	See Digital I/O 1 – Source
43135	Digital I/O 5 – Polarity	0 – Inverted 1 – Non inverted
43136	Digital I/O 6 – Type	See Digital I/O 1 – Type
43137	Digital I/O 6 – Source	See Digital I/O 1 – Source
43138	Digital I/O 6 – Polarity	0 – Inverted 1 – Non inverted

Table B.28: Digital I/O settings

Modbus address	Description	Valid range
43139	Relay 1 – Source	0, and 9 to 44 and 49 to 53 See Table C.3, page 52
43140	Relay 1 – Polarity	0 – inverted 1 – Non inverted
43141	Relay 2 – Source	See Relay 1 – Source
43142	Relay 2 – Polarity	0 – inverted 1 – Non inverted
43143	Relay 3 – Source	See Relay 1 – Source
43144	Relay 3 – Polarity	0 – inverted 1 – Non inverted
43145	Relay 4 – Source	See Relay 1 – Source
43146	Relay 4 – Polarity	0 – inverted 1 – Non inverted
43147	Relay 5 – Source	See Relay 1 – Source
43148	Relay 5 – Polarity	0 – inverted 1 – Non inverted
43149	Relay 6 – Source	See Relay 1 – Source
43150	Relay 6 – Polarity	0 – inverted 1 – Non inverted

Table B.29: Relay settings

B.13 Writable strings

Modbus address	Description	Default
44000	Instrument tag	Navigator 540
44016	Process tag 1	Tag 1
44032	Process tag 2	Tag 2
44048	Process tag 3	Tag 3
44064	Process tag 4	Tag 4
44080	Alarm 1 tag	Alarm 1
44096	Alarm 2 tag	Alarm 2
44112	Alarm 3 tag	Alarm 3
44128	Alarm 4 tag	Alarm 4
44144	Alarm 5 tag	Alarm 5
44160	Alarm 6 tag	Alarm 6
44176	Alarm 7 tag	Alarm 7
44192	Alarm 8 tag	Alarm 8

Table B.30: 16 byte strings

Modbus address	Description	Default
44208	Chart config tag 1	Ch 1
44211	Chart config tag 2	Ch 2
44214	Chart config tag 3	Ch 3
44217	Chart config tag 4	Ch 4

Table B.31: 3 byte strings

Appendix C – Ranges and signals

Source	Range low	Range high	Units
Sodium	0	10000	ppb
Low level dissolved oxygen	0	20000	ppb
Hydrazine	0	1000	ppb
Temperature	5	55	Deg.C
	41	131	Deg.F

Table C.1: Engineering ranges

Signal value	Source name
0	None
1	Sensor 1 concentration
2	Sensor 2 concentration
3	Sensor 3 concentration
4	Sensor 4 concentration
5	Sensor 1 temperature
6	Sensor 2 temperature
7	Sensor 3 temperature
8	Sensor 4 temperature

Table C.2: Analog signal sources

Signal value	Source name
0	None
9	Alarm 1 state
10	Alarm 2 state
11	Alarm 3 state
12	Alarm 4 state
13	Alarm 5 state
14	Alarm 6 state
15	Alarm 7 state
16	Alarm 8 state
17	Sensor 1 failure
18	Sensor 2 failure
19	Sensor 3 failure
20	Sensor 4 failure
21	Sensor 1 out of specification
22	Sensor 2 out of specification
23	Sensor 3 out of specification
24	Sensor 4 out of specification
25	Sensor 1 maintenance
26	Sensor 2 maintenance
27	Sensor 3 maintenance
28	Sensor 4 maintenance
29	Sensor 1 function check
30	Sensor 2 function check
31	Sensor 3 function check
32	Sensor 4 function check
33	Transmitter failure
34	Transmitter out of specification
35	Transmitter maintenance
36	Transmitter function check
37	Sensor 1 calibration in progress
38	Sensor 2 calibration in progress
39	Sensor 3 calibration in progress

Table C.3: Digital signal sources

Signal value	Source name
40	Sensor 4 calibration in progress
41	Sensor 1 calibration failed
42	Sensor 2 calibration failed
43	Sensor 3 calibration failed
44	Sensor 4 calibration failed
45	Sensor 1 low standard calibration
46	Sensor 1 high standard calibration
47	Sensor 1 two point calibration
48	Sensor 1 regeneration + two point calibration
49	Sensor 1 hold
50	Sensor 2 low standard calibration
51	Sensor 2 high standard calibration
52	Sensor 2 two point calibration
53	Sensor 2 regeneration + two point calibration
54	Sensor 2 hold
55	Sensor 3 low standard calibration
56	Sensor 3 high standard calibration
57	Sensor 3 two point calibration
58	Sensor 3 regeneration + two point calibration
59	Sensor 3 hold
60	Sensor 4 low standard calibration
61	Sensor 4 high standard calibration
62	Sensor 4 two point calibration
63	Sensor 4 regeneration + two point calibration
64	Sensor 4 hold

Table C.3: Digital signal sources

Acknowledgements

PROFIBUS is a registered trademark of PROFIBUS and PROFINET International (PI).

Modbus is a registered trademark of the Modbus-IDA organization.

ABB Measurement & Analytics

For your local ABB contact, visit:
www.abb.com/contacts

For more product information, visit:
www.abb.com/measurement

We reserve the right to make technical changes or modify the contents of this document without prior notice. With regard to purchase orders, the agreed particulars shall prevail. ABB does not accept any responsibility whatsoever for potential errors or possible lack of information in this document.

We reserve all rights in this document and in the subject matter and illustrations contained therein. Any reproduction, disclosure to third parties or utilization of its contents – in whole or in parts – is forbidden without prior written consent of ABB.