



brewmaxx

Process Control Systems. MES inside.
The Plant iT™ industry solution for breweries.



The industry solution for the brewing industry

proleit.com

ProLeiT
by Schneider Electric

The industry sector solution for breweries

We started with the development of our process control system brewmaxx over 30 years ago. Today, our PLC-based control system is utilized by over 850 breweries in the areas of automation, information and control technology. Processes can be continuously controlled and monitored with brewmaxx – from production data acquisition, process control technology and recipe-controlled liquid handling to functions for full production management (MES) across locations, and the integration of ERP, LIMS and maintenance systems.

Our process control system brewmaxx was specifically developed to meet the demands of the brewing industry and combines comprehensive IT expertise with brewing know-how. It is perfectly tailored to the day-to-day operations in breweries and enables innovative, user-oriented solutions. brewmaxx can be used for both full-scale or partial automation of a brewery, e.g. for raw material handling, brewhouse, fermentation and storage cellars, yeast management, filter systems, packaging areas, utility plants or CIP stations. Moreover, it is particularly suitable for migration and replacement projects. Implementation of a new brewmaxx system usually occurs in several stages with minimum system downtime or during breaks in production. Impressed by the increasing number of successfully completed projects in this sector, more and more breweries are choosing brewmaxx – the automation solution for breweries that combines experience, trust and efficiency in just one product.

Integrated automation solution

brewmaxx provides master brewers and all other users with invaluable information about all production and business processes. As the foundation for all entrepreneurial decisions, it

links the various processes intelligently and helps to manage a brewery more efficiently and economically.

Development based on principles

Unlike pure system integrators that usually use process visualization system, we focus on industry-specific process automation. Due to our in-house system development, our brewing-specific know-how and our close cooperation with breweries, plant suppliers and universities, we are able to tailor each new version of brewmaxx even better to the requirements of our customers.

Value added with brewmaxx

Process automation with brewmaxx results in considerable savings in time, cost and effort. Resources are used more efficiently. The entire brewery becomes a flexible operation which can react quickly to new conditions and challenges. And last but not least, brewmaxx gives brewers the certainty of always being able to produce beer to the highest possible standards.

MES



ERP



brewmaxx Integrate
Production & Process Monitoring

Plant Management & Scheduling

brewmaxx
Machines & Process Control



CONTROL

Modular system architecture

The brewmaxx product family essentially consists of the brewmaxx process control system and the brewmaxx Integrate MES solution. The process control system can additionally be extended with the following modules:

- brewmaxx material – the process-oriented materials management
 - brewmaxx connect – the interface manager
 - brewmaxx archive manager – the long-term archive solution
 - brewmaxx web portal – web reporting and applications
- brewmaxx Messenger
 - brewmaxx EnMS
 - brewmaxx Visu-Recorder
 - brewmaxx Equipment Modules
 - brewmaxx Routing Management
 - brewmaxx Maintenance
 - brewmaxx LMS
 - brewmaxx Batch Cockpit
 - brewmaxx Workflow
 - brewmaxx Smart Control

The web portal module is already included in the brewmaxx Integrate MES solution.

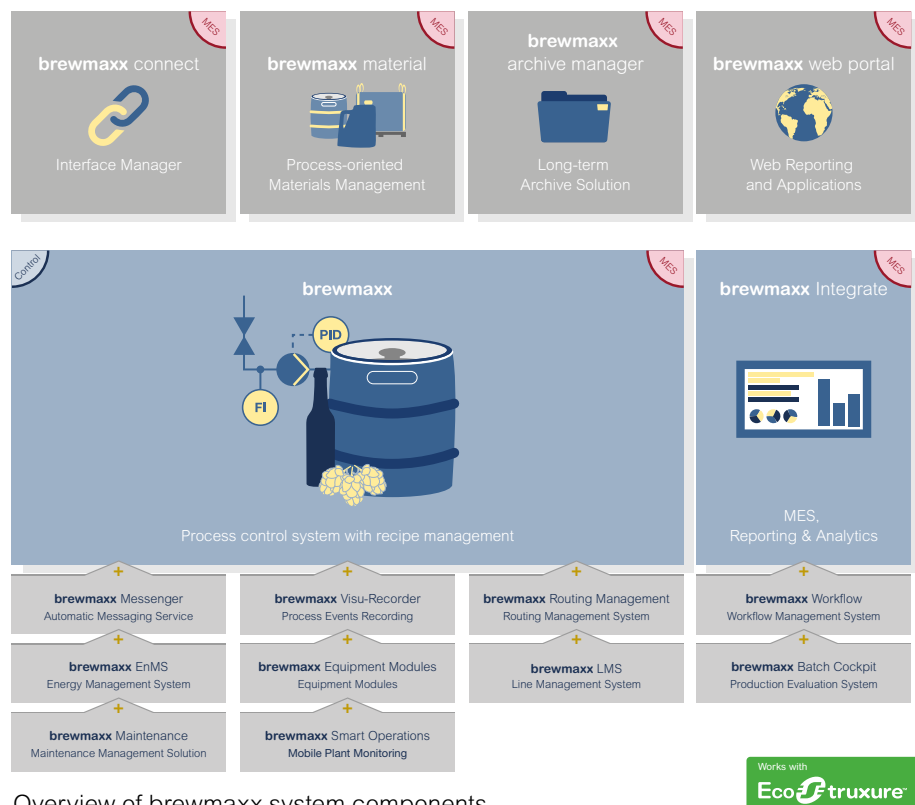



brewmaxx

Process Control System with recipe management

The greatest advantage of brewmaxx is its modular system architecture. The modular system components can map all the process steps of a brewery and offer a seamless and integrated automation solution. The brewmaxx basic system as well as all the modules and add-ons have a centralized engineering infrastructure with a common database and logical user interface for intuitive parameterization. All the brewmaxx modules and add-ons can be retrofitted flexibly at any time. Even the brewmaxx basic system offers an extensive range of services for the specific needs of breweries. Equipped with production data management with a high-performance real-time database, a brewery-specific recipe system for workflow-controlled processes and tank farm management with route control, the brewmaxx process control system is a future-proof solution for handling control and process engineering tasks. As option the following modules and add-ons are available:

Module: brewmaxx material – process-oriented materials management

brewmaxx material enhances the management of order and recipe-controlled production processes through process-related materials management with a transaction-accurate online view of all material transactions. They are recorded on the basis of a process-compliant warehouse structure and besides precise inventory management also enable investigation and evaluations, in particular batch traceability.

Module: brewmaxx connect – interface manager

brewmaxx connect offers an interface with fully configurable parameters for universal data exchange, especially with external systems. Various standard communication channels (e.g. XML/B2MML) are available for linking ERP, laboratory or maintenance systems.



Module: brewmaxx archive manager

The brewmaxx archive manager module offers a solution for archiving all transaction data recorded in the control system. The research requests are executed via existing brewmaxx clients. Various filters (e.g. order number, recipe, receiving goods number) enable convenient search options according to detailed information within the respective batch, including, for instance, recipe parameters, operator intervention or consumption levels.

Module: brewmaxx web portal – web reporting and applications

The browser-based brewmaxx web portal allows users to simply call up reports via a PC, tablet and smartphone. It is not necessary to install third-party software, e.g. Java, Silverlight or Flash. The brewmaxx web portal enables the retrieval of standard production reports (e.g. batch or brew reports) from several production

servers and the retrieval of MES reports. Further, the module features a Software Development Kit (SDK) for generating unique applications.

Add-on: brewmaxx Messenger – automatic messaging service

This add-on sends messages directly from the control system to defined persons. The optional remote messaging system, including escalation management, supports various communication channels, such as emails and text messages.

Add-on: brewmaxx EnMS – energy management system

The qualified energy management system to DIN EN ISO 50001 can be integrated into the process control system at any time. With an appropriate infrastructure, energy consumption within the plant is determined and documented. EnMS therefore forms the basis for continuous process optimization.

Add-on: brewmaxx Visu-Recorder – process events recording

This add-on is a special brewmaxx feature. It records process sequences and outputs them via the standard user interface of the control system. The output function is started directly via the process visualization. Time windows and output speed are freely selectable. User interactions can also be displayed whenever required.

Add-on: brewmaxx Equipment Modules

brewmaxx Equipment Modules (brewmaxx EM) contain technological functions for brewing facilities. Equipment Modules semi-automatically control complex procedures such as tank cooling, for example. One of the major advantages of brewmaxx EM is their high level of standardization, maximum safety as well as their transparency and usability. The option of transferring technological parameters from a higher-order procedure or linking parameters directly to equipment ensures the greatest possible flexibility.

Add-on: brewmaxx Routing Management

The add-on extends the capabilities of the standard route control of the basic system. With this add-on it is possible to integrate rule-based routing orders with dynamic route search and allocation into order processing. Utilizing so-called business rules, it automatically finds a suitable target tank, starts the order and controls the sequence with the corresponding recipe. The use of this add-on usually leads to an increase in plant utilization due to the increase in tank occupancy times.

Add-on: brewmaxx Maintenance

brewmaxx Maintenance is a parameterisable solution for evaluating and planning maintenance tasks. With this add-on, individual automation objects, such as valves, motors and frequency inverters, and entire package units can be managed in a clear and concise manner. Essential functions are the automatic evaluation of system classes, the individual parameterization of maintenance, the graphical evaluation of the switching cycle and – in terms of predictive maintenance – the display of the expected next maintenance date.

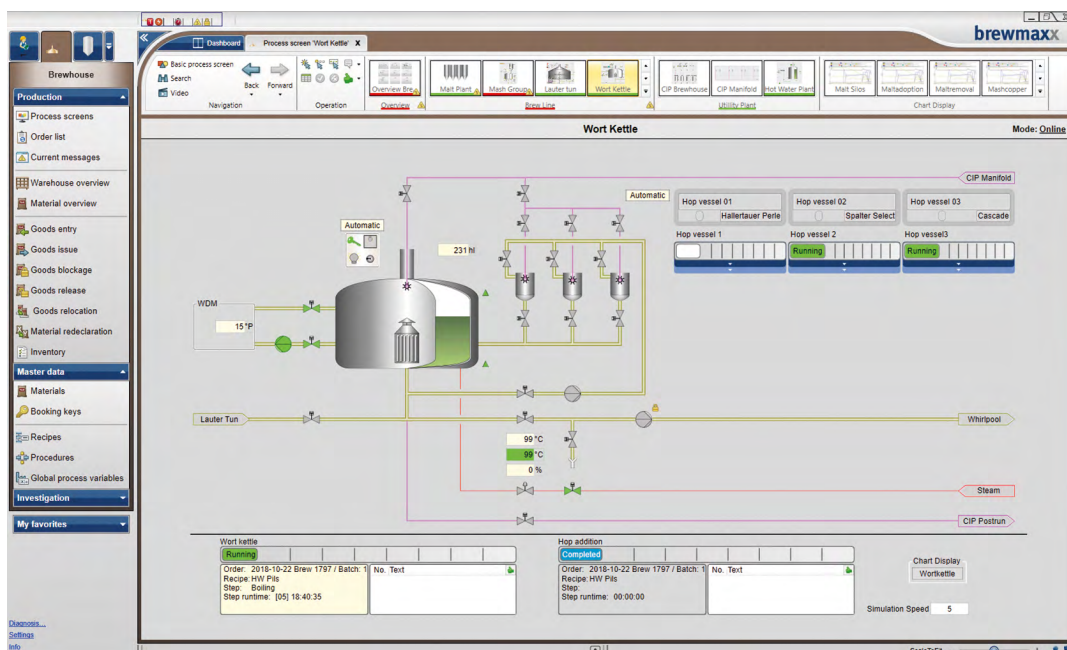

Operation Manager – the central user interface for process operations

Add-on: brewmaxx LMS – line management system

Through brewmaxx LMS, ProLeiT enables simple access into the world of line management. The add-on records the automated downtime of plants and machines. The causes of downtime and other system or order-related data can be entered at any time manually via drop-down boxes. The entire data can be analyzed down to the finest detail with the help of the drill-down-function: Downtime periods can then be arranged hierarchically with varying levels of detail from the overall bottling plant to individual units.

Add-on: brewmaxx Batch Cockpit – production evaluation system

The add-on brewmaxx Batch Cockpit from ProLeiT is a software solution for greater transparency and more effective plant utilization in the brewing industry. The add-on is designed for evaluating, processing and validating production data. It therefore facilitates efficient analysis of the large volumes of batch and process data generated during production proceedings. Process plant operators are provided with a precise overview of their production activities, meaning correlations are detected and potentials fully used. Since data sovereignty, in other words the ability to know which batch is produced when, how and where and at which level of quality, is the key to efficient production processes.

Add-on: brewmaxx Workflow

brewmaxx Workflow is an efficient MES workflow management system that enables the management and monitoring of automatic and manual processes. Order processing, quality assurance (e.g. sampling) and the support of logistics processes are just a few examples. Also possible is the collection and provision of data which arises during production and in the production environment (e.g. in auxiliary plants). This data is used as the basis for production-relevant reporting and as a data source for superordinate systems. The workflow management system can be used for the following MES areas:

- Warehouse and inventory management (e.g. product and material parameters, handling units, stocktaking)
- Production management (e.g. recipe/BOM management, production logistics)
- Quality management (e.g. management of specification values)
- Maintenance and servicing (e.g. operating hours counter, machine maintenance, operating cycle counter)



EcoStruxure™

Innovation At Every Level

Since the merger of ProLeiT and Schneider Electric in August 2020, Plant iT and brewmaxx have been complementing the Schneider Electric EcoStruxure system architecture. Bringing together the expertise of Schneider Electric SE and ProLeiT offers tremendous value to the customers of both companies to increase their productivity and efficiency. The ProLeiT solutions specifically address the consumer packaged goods (CPG) and food & beverage (F&B) sectors and thus enable broad market penetration. Through its own EcoStruxure system architecture, in which the AVEVA software plays an integral role and which is further strengthened by the ProLeiT portfolio, Schneider Electric, a company active in over 100 countries worldwide, has long been successfully driving forward digital transformation in industrial automation.

EcoStruxure is Schneider Electric's open, interoperable, IoT-enabled system architecture and platform. EcoStruxure delivers enhanced value around safety, reliability, efficiency, sustainability, and connectivity for our customers. EcoStruxure leverages advancements in IoT, mobility, sensing, cloud, analytics, and cybersecurity to deliver Innovation at Every Level. This includes Connected Products, Edge Control, and Apps, Analytics & Services which are supported by Customer Lifecycle Software. EcoStruxure has been deployed in almost 500,000 sites with the support of 20,000+ developers, 650,000 service providers and partners, 3,000 utilities and connects over 2 million assets under management.

EcoStruxure™ Innovation At Every Level

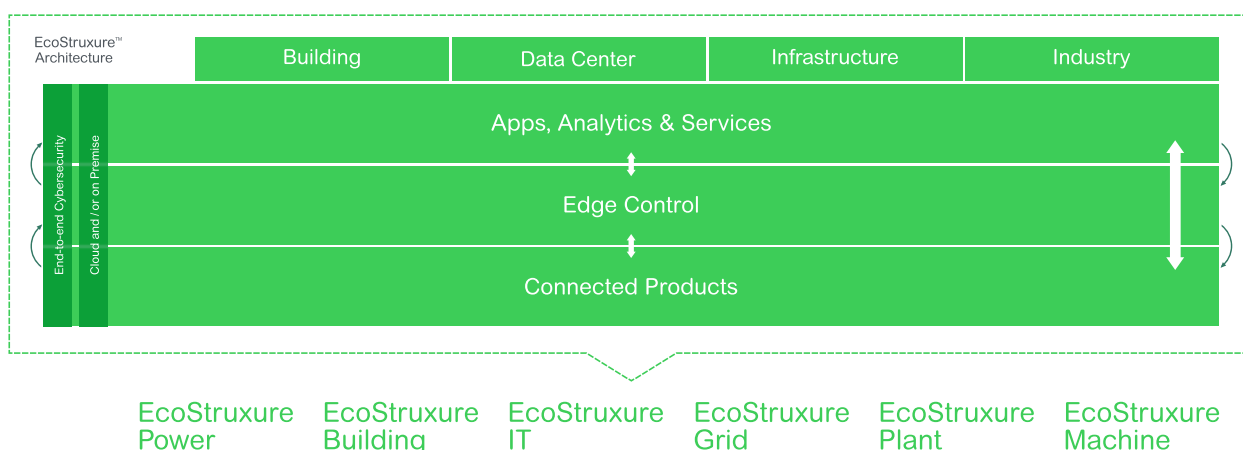

New features of version 9

Usability and design in a perfect harmony

The new Operation Manager is the central user interface for operators and is available not only for the base systems but also for all add-ons and modules. The revamped user interface complies with the latest usability standards and facilitates operation, monitoring and control of production processes.

The presentation of process areas and MES functions, editable menus and numerous new processing functions enables intuitive and effective utilization of the control system. All elements of the new interactive main menu bar and from the slide-out side menu can be added to the new dashboard via drag & drop.

The new function for displaying process pictures on several monitors is particularly convenient. Process pictures can now be moved from the Operation Manager to other monitors. This ensures simpler operation on the latest touch panels with multi-finger operation.

It has never been easier to create complex process images using brewmaxx. The new Process Screen Designer is an integral part of the process control systems and offers

extensive libraries of industry-specific graphic objects which can simply be added via drag & drop.

So called "Prototypes" already have pre-settings (e.g. graphic object, unit) and only have to be linked to one automation object after being added to the process picture.

Automation objects on the other hand already boast all the required settings, e.g. PLC source link. The new vector-based graphical elements are fully scalable and provide optimum display quality for high resolution displays.

With brewmaxx Integrate we have developed new stand-alone MES solution to run with or without our process control system. Production reports can be easily displayed and transferred via a web browser. Based on standard software components (e.g. SSRS from Microsoft) we are able to centrally process and edit information from various sources, whilst ensuring it is displayed in a leading-edge manner on multiple devices.

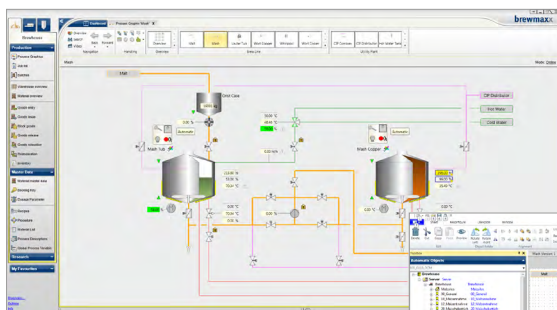

Process screen of a brewery within the Operation Manager

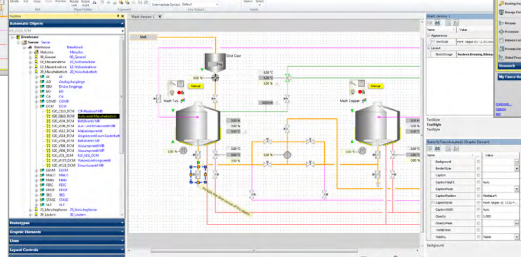

Creation of a process screen with the integrated Process Screen Designer

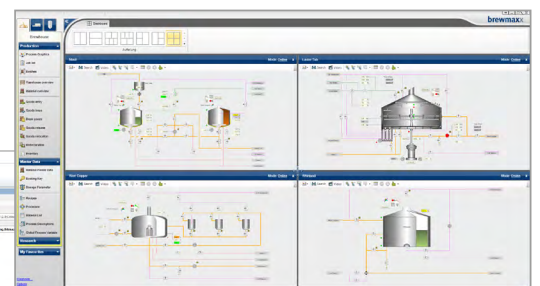

Dashboard of the Operation Manager

Operating dialogues

The new operating dialogues of the Operation Manager have been specially developed for use on touch interfaces. This particularly facilitates the operation of automation objects via mobile end devices, such as controlling valves.

Curve viewer

The new curve viewer of the operation manager optimizes the display of measurement curves while providing additional functions for research, commenting and comparing measured values. This means, for example, that order and batch comparisons from differing time periods can be quickly analysed and displayed.

Process Screen Viewer

The new process screen viewer application enables the display of process images outside the operation manager with an individually adaptable arrangement of the individual process images.



Display of measured values within the Operation Manager

High Attention Library

The new high attention library has been specially developed to graphically highlight messages and faults. The colour contrasts are more visible by discreetly displaying normal states (e.g. white, grey) and indicating alarm states in a bright colour (e.g. red). Faults and warnings can thus be perceived more quickly in complex process images.

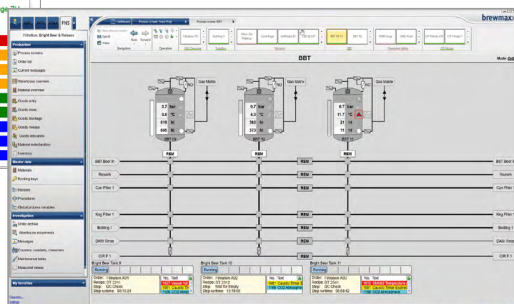

High Attention Library

Stand-alone MES, Webportal & OPC UA server

Stand-alone MES solution

brewmaxx Integrate is a new, stand-alone MES basic systems that can be used together with or without the brewmaxx process control system. Based on standard software components (e.g. SSRS from Microsoft), information from various sources is centrally processed, prepared and displayed on a wide variety of end devices via the web.

Web portal

The brewmaxx web portal ensures the process control system brewmaxx has a host for web applications with standardized user management, language switching and user interface design. This enables the presentation of all types of reports, messages and measured values via web browser. In addition, the web portal contains a software development kit (SDK), which allows the integration of your own websites and third-party components.

New automation classes

In addition to the automation classes for the Modicon M5 series, new classes have been developed specifically for SIMATIC controllers, type S7-1511 to S7-1518. These are particularly suitable for connecting micro plants and package units (e.g. CIP) and provide a further key component for modular automation (MTP).

OPC Unified Architecture Server

OPC UA is the manufacturer-independent communication protocol for automation applications in the process industry. Process and production data can thus be exchanged even faster and more securely with partner systems such as SCADA, ERP or quality management systems, and the continuous communication from individual sensors and actuators to the ERP level is optimized. With OPC UA, the connection of package units or intelligent peripheral modules is fast and simple. Built-in security mechanisms ensure maximum IT security when transferring data points. Secure and ideally prepared for the implementation of Industry 4.0 applications.

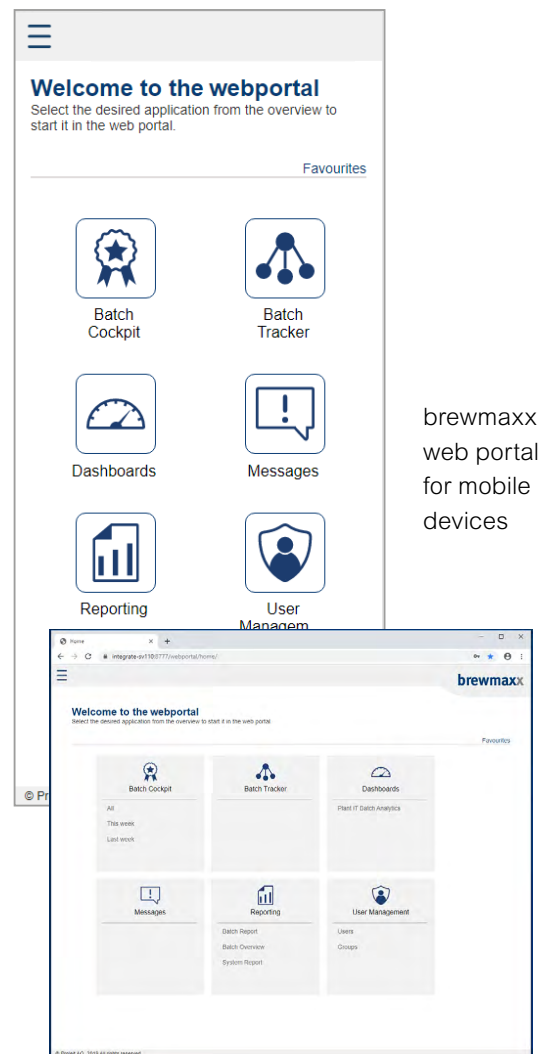

brewmaxx web portal

brewmaxx Smart Control

Mobilize the Control Room

Web applications for mobile devices have the purpose of ensuring a substantial gain of mobility and flexibility for the control and monitoring of fully automated systems.

Our brand-new App Plant iT & brewmaxx Smart Control enables operators to perform production steps such as switching actuators, simulating sensors or acknowledging a fault message via a smartphone, tablet or PC. The newly acquired flexibility allows operators to leave the control room without ever losing sight of the most important plant data. The only requirement is a Plant iT or brewmaxx system version of 9.70 or higher.

Another major advantage of the web application is its quick & simple operation via web browser. Hence, no separate download via App Store is necessary, all that it takes is an installation on the web server.

The key functions of Plant iT/brewmaxx Smart Control:

- **Maximum Flexibility** –
Wherever you are - with Smart Control, the entire plant can be monitored and controlled from any location. Faults and notices can be acknowledged. Sequence controls can be paused and resumed.
- **Optimal Support** –
Our App is not only the ideal support for plant operators and shift supervisors, but also extremely useful in maintenance, commissioning and servicing. Expensive terminals on site are no longer needed.
- **High Data Security Level** –
To ensure a high level of data security, the application is equipped with a wide range of security functions. The entire data exchange between the user and the Plant iT system takes place via TLS encryption. Furthermore, the reading of data and writing of commands is only possible for

authenticated users with enabled user rights.

- **Responsive Design** –
The application is fully adapted to the screen resolutions of smartphones, tablets and PCs, allowing usage on your device of choice.
- **Integrated Help Functions** –
An integrated help function within the app supports the user in case of questions about the app and its operation. Even without prior training or daily use of the control system, smooth handling is guaranteed.
- **Easy Data Exchange** –
The App enables users to assign each object with a unique URL and thus share objects or map their access in the form of a QR code, e.g. to notify maintenance staff about a problem object.

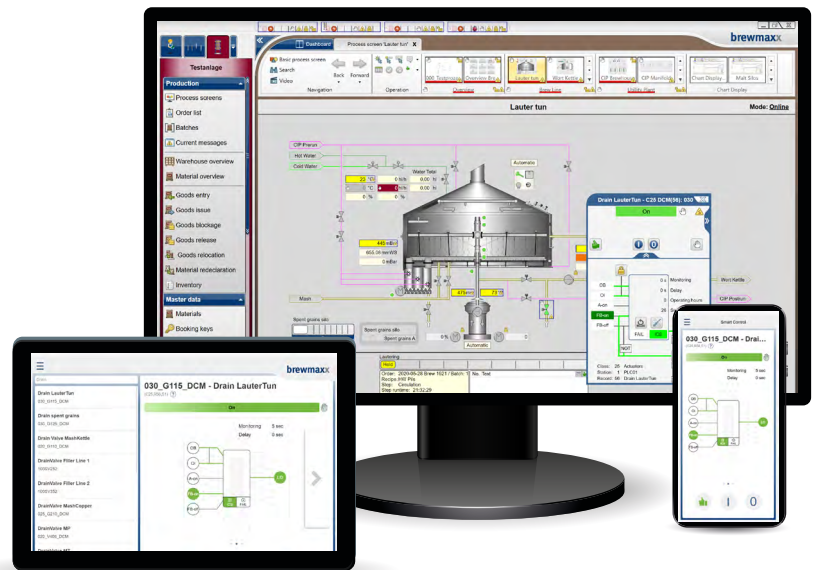

brewmaxx

System requirements



System overview

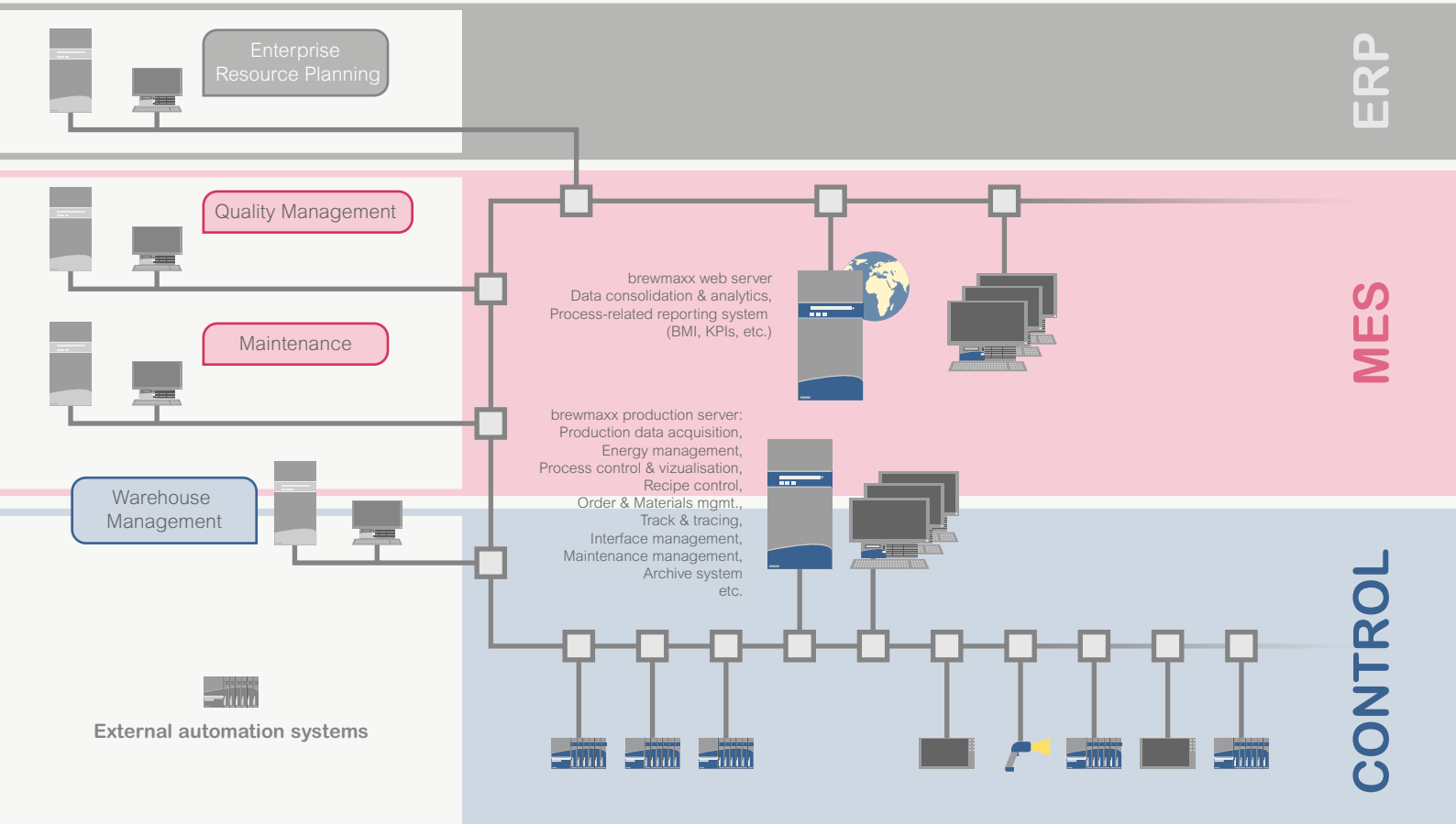

Add-on: brewmaxx Routing Management

Intelligent source, target and route selection

The standard route control, already included in the basic system, can optionally be extended with the Routing Management add-on. This add-on offers automated source and target tank selection as well as a dynamic route search for material transfers. It is based on parameterized routes and uses configured routing rules for selection.

Routing Management provides operators with support for the efficient and reliable selection of routes. Moreover, the add-on guarantees a significant improvement in plant efficiency, since tanks are utilized optimally, for instance. The add-on also offers many advantages with regard to saving resources, e.g. energy or media: Unnecessary cleaning processes can be avoided (e.g. when producing different types of beer) by using the correct routes. Various additional functions such as the automatic compatibility check, status and brand testing as well as the integrated mutation (production of a new brand from various basic products) complete the extensive range of services provided by ProLeiT Routing Management.

Integrated in the standard user interface

Routing Management is controlled via the brewmaxx standard user interface, the Operation Manager. When using Routing Management, every selection can be tracked seamlessly, with three operating options available: fully automatic, semi-automatic (automatic selection and manual confirmation by the operator) and manual.

Comfortable planning of routing orders

Each process area contains a sub-folder for rule-based routing orders. This folder contains a route matrix in which the existing routes are planned per sequence. Several routing rules (so-called business rules) can be created for one rule-based routing order. The plant statuses of the storage and transfer units are evaluated and the material taken into account.

A routing rule defines how the routing process is to be processed and how the order is started in the Operation Manager. Orders can either be created and carried out manually on site or started automatically. The order template is also specified in the routing rule. The order template determines the sub-procedure to be started from the recipe or the procedure. The prerequisite for the planning of routing processes requires a basic parameterization of sequences with respective FIFO objects (First In, First Out), a suitable order template and a procedure or a recipe to be started by the routing process.

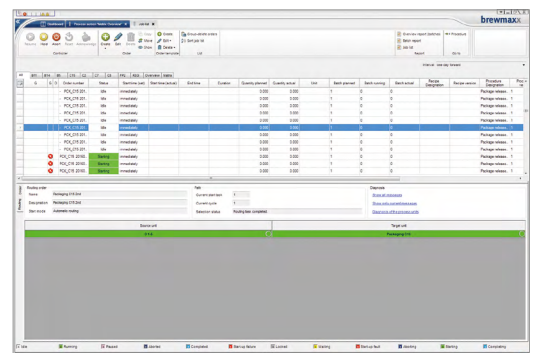

brewmaxx Routing Management user dialogue

brewmaxx Integrate

MES, reporting & analytics

brewmaxx Integrate is a brewery-specific MES solution and offers effective methods for the targeted management of production information. The assignment of data from subordinate systems (e.g. brewhouse, filter, cellar, bottling) to the target database (MES) is achieved via the staging area. With the help of an integrated configuration tool, data can be easily extracted, transformed and loaded (ETL process) into the target database (MES). In the subordinate source systems, it is possible to configure which values are to be transferred to the target database. Four categories are available for this:

- Physical model
- Material model
- Procedural model
- Booking model

Specification Management

Specifications with up to four limit values can be assigned to any parameters from the subordinate systems. This enables the subsequent visual presentation of process deviations. Peculiarities can thus be identified, analyzed and corrected quickly.

The values transferred from the brewmaxx database can be classified into freely definable categories within the target system for subsequent analysis. Process sequences can thus be tracked long-term using these filters and correlations can be recognized easily.

ERP systems do not usually have a technically detailed view of brewery production processes. brewmaxx Integrate, however, provides shift supervisors and plant and production managers with all the relevant data in a clear and detailed manner.

Analytics dashboards

By using the dynamic analytics dashboards in brewmaxx Integrate, it is possible to process and prepare information from various sources at a central location before displaying it accurately on state-of-the-art end devices thanks to visual analytics.

The intuitive user interface can be used with a variety of end devices (PCs, tablets, cell phones, etc.) and is always easy to operate. Diagrams can be changed dynamically without changing the actual layout. Frequently used settings and queries (e.g. in the form of filters) can be conveniently saved as bookmarks.

The analytics dashboards are an integral part of brewmaxx Integrate and are delivered with pre-configured, brewery-specific layouts. Subsequent additions and individual adaptations are possible at any time and can be carried out independently with very little effort. Current additions include a production manager dashboard, a golden batch comparison and a KPI evaluation using heat maps.

brewmaxx Cloud Connector ensures ideal connection to cloud services such as Microsoft Azure or Amazon Web Services. Prepared process and measured values are available for collection by cloud solutions and subsequent location-independent analysis. Cloud Connector allows plant operators to benefit from context-sensitive data and their company-wide availability in the cloud. This enables flexible data analysis using artificial intelligence (AI) or machine learning (ML).

With brewmaxx Integrate it is possible to quickly evaluate mass data and to focus on the essential information provided. Thanks to brewmaxx Integrate, breweries can detect and eliminate deviations within a very short space of time.

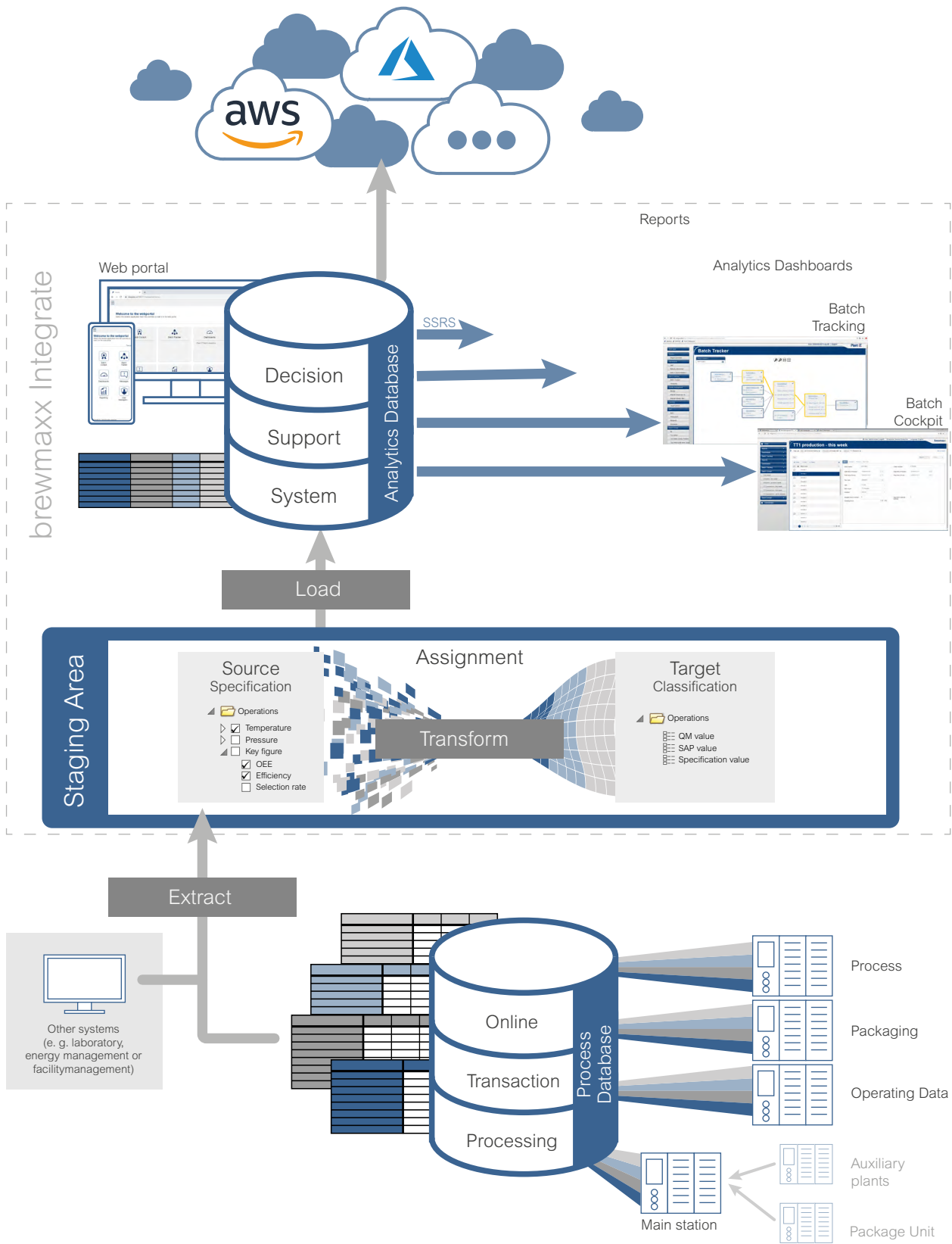

brewmaxx Integrate – Integration of process data in the MES database via the staging area

brewmaxx for craft breweries

Recipe system with an unlimited number of recipes

Initiated by creative beer brewers in the USA, craft breweries worldwide now represent high-quality and individually produced beer specialities. In addition to the high product quality, craft brewers focus on the individual brewing process. As a result, the automation solutions for such breweries need to be designed accordingly. The continued growth of a successful craft beer brewery demands more scalable operations to ensure consistent quality and taste stability. A flexible recipe system without limitations is also of great importance.

Improving production quality, increasing production output, reducing production times

brewmaxx is ideal for entry into the world of automation – always focusing on the best possible quality and the special, extraordinary variety of craft beers. Here, the clever recipe

system supports a quick creation of new beers. This way any craft brewer can react even faster to market requirements with brewmaxx. The following points, in particular, promise key advantages in all brewing processes:

Scalability

The transparent and scalable licence model of brewmaxx enables the process control system to grow together with the craft brewery. It can be easily expanded at any time, thereby offering excellent investment protection.

Productivity

With a high-performance automation solution such as brewmaxx, all the brewing processes within a craft brewery can be optimized. This ensures more produced brews each day – while



maintaining the same high product quality.

Flexibility

brewmaxx complies with the principle of “parameterization instead of programming”. Due to its unique class concept, just one software module with fully configurable parameters always controls and monitors all similar objects within the plant. Compared to conventional process control systems, this has an array of positive impacts, such as shorter commissioning times or more efficient procedures for extensions and migrations.

The integrated brewmaxx recipe control and management not only allows craft brewers to modify and refine existing recipes, but also gives them creative leeway when it comes to creating new varieties.

Transparency

In a growing brewery, more tasks inevitably arise than staff can actually keep an eye on. The brewmaxx tracking and tracing functionality ensures complete documentation at all times. Plant operators can quickly and clearly trace the route of their beer and its ingredients along the entire production chain.

Thanks to this full traceability, it is possible to see at a glance what was produced by whom, when and where.

Openness

As an independent company, we work together with all well-known plant manufacturers. brewmaxx was developed for programmable logic controllers of Schneider Electric, Siemens and Rockwell Automation and gives craft brewers the freedom to choose their preferred suppliers. Even in the event of a subsequent change of supplier, the projected performance is still maintained.

Thanks to brewmaxx, ProLeiT offers craft brewery operators a PLC-based, scalable automation solution that optimizes production processes, enables flexible recipe adaptations and reduces the time required to manage devices and processes. This ensures that craft brewers can concentrate on the essentials: Making well-rounded, tasty beers.



brewmaxx compact

Process control for compact units

One of the leading process control systems for the brewing industry is available as a compact entry-level solution, that is suitable for the automation of smaller units such as the pasteurizer, the heater or the CIP system. This package consists of brewmaxx compact with pre-configured automation classes, up to two workstations and one programmable logic controller (PLC).

Manufacturers as well as machine and plant suppliers can utilize brewmaxx compact for applications ranging from production data acquisition (PDA) through to full process control. It is an optimized solution for smaller plant areas like utilities, water treatment, filtration and CO² plant or suitable for smaller brewhouses.

Benefits of brewmaxx compact:

- Minimal investment costs – for software and hardware
- Easy handling and operation – pre-configured brewmaxx process control system
- Integrated Ethernet extension* – use of the onboard ethernet interface of the PLC
- Minimal hardware requirements – serverless process control system
- Multi-language support – for english, spanish, german, french, russian and portuguese
- Scalability of brewmaxx – reusability of engineering makes expansion to full system easy
- brewmaxx Visu-Recorder as an integral part of the system – Recording and replay of process activities

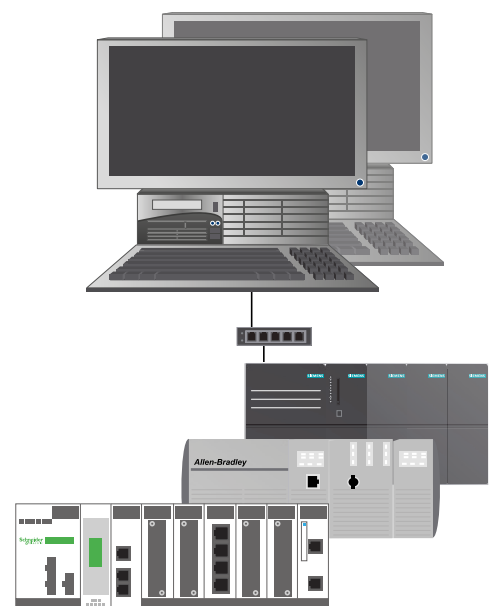

* for Siemens controllers only

brewmaxx express

Process control for small up to mid-size plants

One of the leading process control systems for the brewing industry is now available as a compact entry-level solution. This package consists of pre-configured automation classes, step sequences, order list and recipe management. The brewmaxx express license is available for up to two clients and two programmable logic controllers (PLCs) and is, therefore, ideally suited for automating smaller plant areas, for example a brewhouse.

Manufacturers as well as machine and plant suppliers can utilize brewmaxx express for applications ranging from production data acquisition (PDA) through to full process control. It is an optimized solution for smaller plant areas like utilities, water treatment, filtration and CO² plant or suitable for smaller brewhouses.

Benefits of brewmaxx express:

- Easy handling and operation – pre-configured brewmaxx process control system
- Two full clients and PLCs – for small up to mid-size plants
- Extensive automation classes – matches the scope of the brewmaxx full version
- Minimal hardware requirements – serverless process control system
- Multi-language support – for english, spanish, german, french, russian and portuguese
- Scalability of brewmaxx – reusability of engineering makes expansion to full system easy
- Discounted licence fees for the brewmaxx Visu-Recorder express – recording and output of process visualization

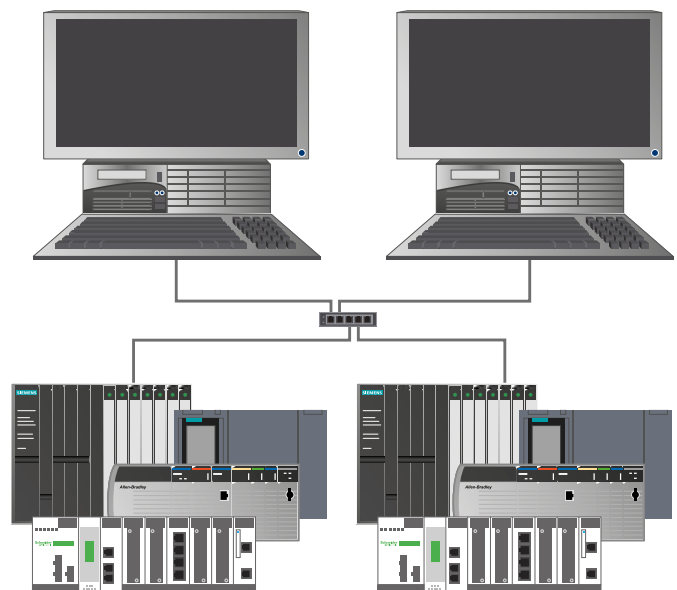

Intuitive UI and extended MES functionality

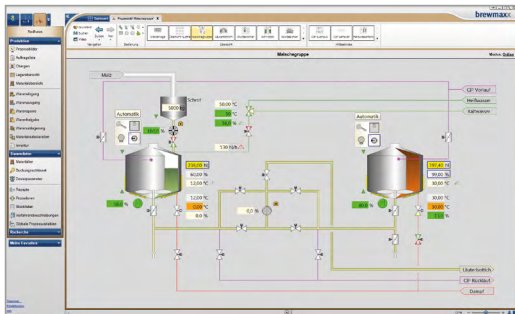

Operation Manager

The Operation Manager is the central user interface for operators and is available not only for the standard brewmaxx process control system but also for all add-ons and modules. The revamped user interface complies with the latest usability standards and facilitates operation, monitoring and control of production processes in a brewery. The presentation of process areas and MES functions, editable menus and numerous new processing functions enables intuitive and effective utilization of the control system.

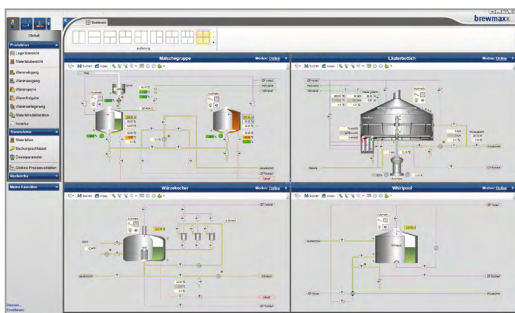

Operation Manager - Dashboard

All the elements of the interactive main menu bar and from the slide-out side menu can be added to the dashboard via drag & drop. A dashboard can be created and saved individually for each user. The function for displaying process pictures on several monitors is particularly convenient. Process pictures can be moved from the Operation Manager to other monitors. The user interface of the Operation Manager has been optimized for use with multi-touch screens. This ensures simpler operation of the latest touch panels with multi-finger operation.

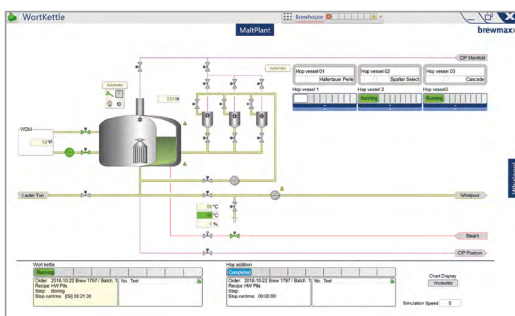

Process Screen Viewer

Processes in state-of-the-art breweries are becoming more and more flexible, and the demands placed on operating staff are increasing accordingly. ProLeiT combats this development through a particularly clear design of its systems that complies with all the latest usability standards and also enables local operation via a touch panel: Improved icons guarantee intuitive operation of the user interface, while dynamic display techniques ensure only the really relevant functionalities and processes are displayed (depending on the respective user role and workstation). The process image viewer – a compact visualization tool – also allows the individual compilation and arrangement of the process images that are of interest to the respective workstation or user.

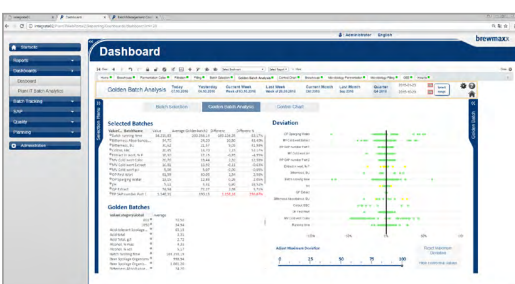

brewmaxx Integrate

brewmaxx Integrate extends the MES functionality of the standard process control system. It is a MES report system which is separate to the productive server and compiles the historic data of a brewmaxx server and various third-party systems in an operational data store (ODS). It can be used as a central MES reporting system for breweries and enables the presentation of analyses and production reports, e.g. via web browser. Furthermore, brewmaxx Integrate can be extended with a workflow management system for production-relevant business processes. This database-aided system is usually used for managing and monitoring manual processes in the production environment.

brewmaxx system advantages

Schneider
Electric

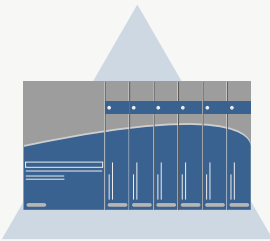

Rockwell
Automation

Siemens

Our process control systems are designed for the hardware platforms of global market leaders.

Modular construction

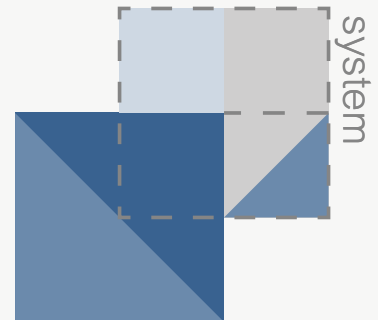

Our modular construction system enables you to put together the ideal solution to meet your needs.



The new user interface has been developed to the latest standards and with the help of usability experts. This results in time savings and a high level of user acceptance. New operators become familiarized with procedures in a minimum amount of time.

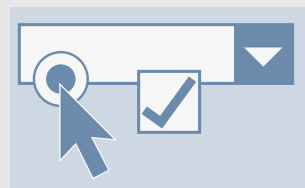

```
#include <string.h>
int main(void)
{
    call recipe;
}
```

Why waste your precious time programming applications when you can simply configure and parameterize our system.



brewmaxx is the product of over 30 years' experience and expertise in the management of brewing processes. Born from the desire to develop a process control system, which meets the most modern of demands, the specific technical know-how of our systems developers was blended with the technological expertise of our own master brewers. In conjunction with intensive dialog with customers and universities, brewmaxx has developed into the preferred system solution worldwide. Today, brewmaxx is used around the world and controls breweries with an annual output of more than 300 million hectolitres – i.e. almost one fifth of global beer production.



Visit us on
proleit.com

ProLeiT GmbH
Einsteinstr. 8 | 91074 Herzogenaurach | Germany
Tel: +49 9132 777 0 | Fax: +49 9132 777 150 | info@proleit.com

© 2023 ProLeiT

Plant iT and brewmaxx are registered trademarks of ProLeiT. Schneider Electric, Microsoft, Rockwell Automation, SAP, Siemens, Windows and all other brand names used and not mentioned here are registered trademarks of the respective companies. The information in this document contains general descriptions and performance features that may not always apply to the concrete application case in the specified form or may change to subsequent further development of the different system components. Some of the graphics and images used in this document are just examples and may differ from the delivery status. ProLeiT and all subsidiaries are responsible for system functions and services according to the respective express contractual scope of supply and services only.